

FCC Test Report (WLAN)

Report No.: RFBBUI-WTW-P21040655-1

FCC ID: TX2-RTL8852BE

Test Model: RTL8852BE

Received Date: Apr. 21, 2021

Test Date: May 20 to July 13, 2021

Issued Date: Aug. 02, 2021

Applicant: Realtek Semiconductor Corp.

Address: No. 2, Innovation Road II, Hsinchu Science Park, Hsinchu 300, Taiwan

Issued By: Bureau Veritas Consumer Products Services (H.K.) Ltd., Taoyuan Branch
Hsin Chu Laboratory

Lab Address: E-2, No.1, Li Hsin 1st Road, Hsinchu Science Park, Hsinchu City 300,
Taiwan

Test Location: E-2, No.1, Li Hsin 1st Road, Hsinchu Science Park, Hsinchu City 300,
Taiwan

**FCC Registration /
Designation Number:** 723255 / TW2022



This report is for your exclusive use. Any copying or replication of this report to or for any other person or entity, or use of our name or trademark, is permitted only with our prior written permission. This report sets forth our findings solely with respect to the test samples identified herein. The results set forth in this report are not indicative or representative of the quality or characteristics of the lot from which a test sample was taken or any similar or identical product specifically and expressly noted. Our report includes all of the tests requested by you and the results thereof based upon the information that you provided to us. You have 60 days from date of issuance of this report to notify us of any material error or omission caused by our negligence, provided, however, that such notice shall be in writing and shall specifically address the issue you wish to raise. A failure to raise such issue within the prescribed time shall constitute your unqualified acceptance of the completeness of this report, the tests conducted and the correctness of the report contents. Unless specific mention, the uncertainty of measurement has been explicitly taken into account to declare the compliance or non-compliance to the specification.

Table of Contents

Release Control Record	4
1 Certificate of Conformity	5
2 Summary of Test Results	6
2.1 Measurement Uncertainty.....	6
2.2 Modification Record.....	6
3 General Information	7
3.1 General Description of EUT (WLAN).....	7
3.2 Description of Test Modes.....	10
3.2.1 Test Mode Applicability and Tested Channel Detail.....	12
3.3 Duty Cycle of Test Signal.....	19
3.4 Description of Support Units.....	23
3.4.1 Configuration of System under Test.....	24
3.5 General Description of Applied Standard and References.....	25
4 Test Types and Results	26
4.1 Radiated Emission and Bandedge Measurement.....	26
4.1.1 Limits of Radiated Emission and Bandedge Measurement.....	26
4.1.2 Test Instruments.....	27
4.1.3 Test Procedure.....	30
4.1.4 Deviation from Test Standard.....	31
4.1.5 Test Setup.....	31
4.1.6 EUT Operating Condition.....	32
4.1.7 Test Results (Mode 1).....	33
4.1.8 Test Results (Mode 2).....	199
4.2 Conducted Emission Measurement.....	365
4.2.1 Limits of Conducted Emission Measurement.....	365
4.2.2 Test Instruments.....	365
4.2.3 Test Procedure.....	366
4.2.4 Deviation from Test Standard.....	366
4.2.5 Test Setup.....	366
4.2.6 EUT Operating Condition.....	366
4.2.7 Test Results.....	367
4.3 Transmit Power Measurement.....	369
4.3.1 Limits of Transmit Power Measurement.....	369
4.3.2 Test Setup.....	369
4.3.3 Test Instruments.....	370
4.3.4 Test Procedure.....	370
4.3.5 Deviation from Test Standard.....	370
4.3.6 EUT Operating Condition.....	370
4.3.7 Test Results (Mode 1).....	371
4.3.8 Test Results (Mode 2).....	405
4.4 Occupied Bandwidth Measurement.....	425
4.4.1 Test Setup.....	425
4.4.2 Test Instruments.....	425
4.4.3 Test Procedure.....	425
4.4.4 Test Results (Mode 1).....	426
4.4.5 Test Results (Mode 2).....	431
4.5 Peak Power Spectral Density Measurement.....	435
4.5.1 Limits of Peak Power Spectral Density Measurement.....	435
4.5.2 Test Setup.....	435
4.5.3 Test Instruments.....	435
4.5.4 Test Procedure.....	435
4.5.5 Deviation from Test Standard.....	435
4.5.6 EUT Operating Condition.....	435

4.5.7 Test Results (Mode 1).....	436
4.5.8 Test Results (Mode 2).....	446
4.6 Frequency Stability Measurement	454
4.6.1 Limits of Frequency Stability Measurement	454
4.6.2 Test Setup.....	454
4.6.3 Test Instruments	454
4.6.4 Test Procedure	454
4.6.5 Deviation from Test Standard	455
4.6.6 EUT Operating Condition	455
4.6.7 Test Results	456
4.7 6dB Bandwidth Measurement.....	457
4.7.1 Limits of 6dB Bandwidth Measurement.....	457
4.7.2 Test Setup.....	457
4.7.3 Test Instruments	457
4.7.4 Test Procedure	457
4.7.5 Deviation from Test Standard	457
4.7.6 EUT Operating Condition	457
4.7.7 Test Results (Mode 1).....	458
4.7.8 Test Results (Mode 2).....	461
5 Pictures of Test Arrangements.....	464
Annex A - Radiated Out of Band Emission (OOBE) Measurement (For U-NII-3 band)	465
Annex A.1 - Test Results (Mode 1)	465
Annex A.2 - Test Results (Mode 2)	477
Annex B - Band-Edge Measurement (For U-NII-1, U-NII-2A, U-NII-2C band)	489
Annex B.1 - Test Results (Mode 1).....	489
Annex B.1 - Test Results (Mode 2).....	517
Appendix – Information of the Testing Laboratories	545



Release Control Record

Issue No.	Description	Date Issued
RFBBUI-WTW-P21040655-1	Original release.	Aug. 02, 2021

1 Certificate of Conformity

Product: 11ax RTL8852BE Combo module

Brand: REALTEK

Test Model: RTL8852BE

Sample Status: Engineering sample

Applicant: Realtek Semiconductor Corp.

Test Date: May 20 to July 13, 2021

Standard: 47 CFR FCC Part 15, Subpart E (Section 15.407)
ANSI C63.10: 2013

The above equipment has been tested by **Bureau Veritas Consumer Products Services (H.K.) Ltd., Taoyuan Branch**, and found compliance with the requirement of the above standards. The test record, data evaluation & Equipment Under Test (EUT) configurations represented herein are true and accurate accounts of the measurements of the sample's EMC characteristics under the conditions specified in this report.

Prepared by : Vivian Huang , **Date:** Aug. 02, 2021
Vivian Huang / Specialist

Approved by : Clark Lin , **Date:** Aug. 02, 2021
Clark Lin / Technical Manager

2 Summary of Test Results

47 CFR FCC Part 15, Subpart E (Section 15.407)			
FCC Clause	Test Item	Result	Remarks
15.407(b)(6)	AC Power Conducted Emissions	Pass	Meet the requirement of limit. Minimum passing margin is -14.52dB at 25.875 MHz.
15.407(b) (1/2/3/4(i/ii)/6)	Radiated Emissions & Band Edge Measurement*	Pass	Meet the requirement of limit. Minimum passing margin is -1.5 dB at 5350.00 MHz, 5727.81 MHz, 5148.00 MHz, 5353.63 MHz, 5496.91 MHz, 5725.00 MHz, 5150.00 MHz, 5470.00 MHz, 5736.44 MHz, 5929.56 MHz, 5361.10 MHz, 5467.25 MHz, 5736.69 MHz, 5643.50 MHz, 5148.36 MHz and 5351.20 MHz
15.407(a)(1/2/3)	Max Average Transmit Power	Pass	Meet the requirement of limit.
---	Occupied Bandwidth Measurement	-	Reference only.
15.407(a)(1/2/3)	Peak Power Spectral Density	Pass	Meet the requirement of limit.
15.407(e)	6dB bandwidth	Pass	Meet the requirement of limit. (U-NII-3 Band only)
15.407(g)	Frequency Stability	Pass	Meet the requirement of limit.
15.203	Antenna Requirement	Pass	Antenna connector is i-pex(MHF) not a standard connector.

Note:

- For U-NII-3 band compliance with rule part 15.407(b)(4)(i), the OOB test plots were recorded in Annex A.
- For U-NII-1, U-NII-2A, U-NII-2C band compliance with rule 15.407(b) of the band-edge items, the test plots were recorded in Annex B. Test Procedures refer to report 4.1.3.
- Determining compliance based on the results of the compliance measurement, not taking into account measurement instrumentation uncertainty.

2.1 Measurement Uncertainty

Where relevant, the following measurement uncertainty levels have been estimated for tests performed on the EUT as specified in CISPR 16-4-2:

Measurement	Frequency	Expanded Uncertainty (k=2) (±)
Conducted Emissions at mains ports	150kHz ~ 30MHz	1.9 dB
Radiated Emissions up to 1 GHz	9kHz ~ 30MHz	3.1 dB
	30MHz ~ 1GHz	5.1 dB
Radiated Emissions above 1 GHz	1GHz ~ 18GHz	5.1 dB
	18GHz ~ 40GHz	5.3 dB

2.2 Modification Record

There were no modifications required for compliance.

3 General Information

3.1 General Description of EUT (WLAN)

Product	11ax RTL8852BE Combo module
Brand	REALTEK
Test Model	RTL8852BE
Status of EUT	Engineering sample
Power Supply Rating	3.3Vdc from host equipment
Modulation Type	CCK, DQPSK, DBPSK for DSSS 64QAM, 16QAM, QPSK, BPSK for OFDM 256QAM for OFDM in 11ac mode and VHT (20/40) mode in 2.4GHz 1024QAM for OFDMA in 11ax HE mode
Modulation Technology	DSSS, OFDM, OFDMA
Transfer Rate	802.11b: up to 11 Mbps 802.11a/g: up to 54 Mbps 802.11n: up to 300 Mbps 802.11ac: up to 866.7 Mbps 802.11ax: up to 1201 Mbps
Operating Frequency	2.4GHz: 2.412 ~ 2.472 GHz 5GHz: 5.18 ~ 5.24 GHz, 5.26 ~ 5.32 GHz, 5.50 ~ 5.72 GHz, 5.745 ~ 5.825 GHz
Number of Channel	2.4GHz: 802.11b, 802.11g, 802.11n (HT20), VHT20, 802.11ax (HE20): 13, 802.11n (HT40), VHT40, 802.11ax (HE40): 9 5GHz: 802.11a, 802.11n (HT20), 802.11ac (VHT20), 802.11ax (HE20): 25 802.11n (HT40), 802.11ac (VHT40), 802.11ax (HE40): 12 802.11ac (VHT80), 802.11ax (HE80): 6
Output Power	For 2TX CDD Mode: 2.4 GHz: 307.683 mW 5.18 ~ 5.24 GHz: 247.192 mW 5.26 ~ 5.32 GHz: 248.568 mW 5.5 ~ 5.72 GHz: 244.863 mW 5.745 ~ 5.825 GHz: 348 mW Beamforming Mode: 2.4 GHz: 304.343 mW 5.18 ~ 5.24 GHz: 156.619 mW 5.26 ~ 5.32 GHz: 156.367 mW 5.5 ~ 5.72 GHz: 156.336 mW 5.745 ~ 5.825 GHz: 320.286 mW For 1TX 2.4 GHz: 175.792 mW 5.18 ~ 5.24 GHz: 172.187 mW 5.26 ~ 5.32 GHz: 173.38 mW 5.5 ~ 5.72 GHz: 171.791 mW 5.745 ~ 5.825 GHz: 176.604 mW
Antenna Type	Refer to Note
Antenna Connector	Refer to Note
Accessory Device	NA

Data Cable Supplied	NA
---------------------	----

Note:

1. The EUT has below HW SKU configuration, as below table:

SKU No.	Interface	Description
1	PCIe + USB	Single antenna port
2	PCIe + USB	Dual antenna port
3	PCIe + UART	Dual antenna port

Note: From the above HW SKUs, for conducted emission & radiated below 1GHz the worse case was found in **SKU No.: 3** and other test items the worse case was found in **SKU No.: 2**. Therefore only the test data of the SKU was recorded in this report.

2. Simultaneously transmission condition.

Condition	Technology	
1	WLAN 5GHz	Bluetooth

Note: The emission of the simultaneous operation has been evaluated and no non-compliance was found.

3. The antennas provided to the EUT, please refer to the following table:

Ant. Set	RF Chain No.	Brand	Model	Ant. Net Gain (dBi)	Frequency Range (GHz)	Ant. Type	Connector Type	Cable Length (mm)
1	Chain 0	ARISTOTLE	RFA-27-JP326-MHF4300	3.5	2.4~2.4835	PIFA	i-pex(MHF)	300
				5	5.15~5.85			
				5	5.875~7.125			
	Chain 1	ARISTOTLE	RFA-27-JP326-MHF4300	3.5	2.4~2.4835	PIFA	i-pex(MHF)	300
				5	5.15~5.85			
				5	5.875~7.125			
2	Chain 0	ARISTOTLE	RFA-27-C38H1-MHF4300	3	2.4~2.4835	Dipole	i-pex(MHF)	300
				5	5.15~5.85			
				5	5.875~7.125			
	Chain 1	ARISTOTLE	RFA-27-C38H1-MHF4300	3	2.4~2.4835	Dipole	i-pex(MHF)	300
				5	5.15~5.85			
				5	5.875~7.125			

Note:

- From the above transmission chains, the worse case was found in transmission on Chain 0 for 1TX mode. Therefore only the test data of the mode was recorded in this report.
- The Bluetooth technology will fix transmission on Chain 1.
- Max. gain was selected for the final test, except for the radiated emissions test.

4. The EUT incorporates a MIMO function:

2.4GHz Band		
MODULATION MODE	TX & RX CONFIGURATION	
802.11b	2TX/1TX Diversity	2RX
802.11g	2TX/1TX Diversity	2RX
802.11n (HT20)	2TX/1TX Diversity	2RX
802.11n (HT40)	2TX/1TX Diversity	2RX
VHT20	2TX/1TX Diversity	2RX
VHT40	2TX/1TX Diversity	2RX
802.11ax (HE20)	2TX/1TX Diversity	2RX
802.11ax (HE40)	2TX/1TX Diversity	2RX
802.11ax (RU26/52/106/242/484)	2TX/1TX Diversity	2RX
5GHz Band		
MODULATION MODE	TX & RX CONFIGURATION	
802.11a	2TX/1TX Diversity	2RX
802.11n (HT20)	2TX/1TX Diversity	2RX
802.11n (HT40)	2TX/1TX Diversity	2RX
802.11ac (VHT20)	2TX/1TX Diversity	2RX
802.11ac (VHT40)	2TX/1TX Diversity	2RX
802.11ac (VHT80)	2TX/1TX Diversity	2RX
802.11ax (HE20)	2TX/1TX Diversity	2RX
802.11ax (HE40)	2TX/1TX Diversity	2RX
802.11ax (HE80)	2TX/1TX Diversity	2RX
802.11ax (RU26/52/106/242/484/996)	2TX/1TX Diversity	2RX

Note:

1. All of modulation mode support beamforming function except 802.11a/b/g modulation mode.
2. The EUT support Beamforming and CDD mode, therefore both mode were investigated and the worst case scenario was identified. The worst case data were presented in test report.
3. The modulation and bandwidth are similar for 802.11n mode for 20MHz (40MHz), VHT mode for 20MHz (40MHz, 80MHz) and 802.11ax mode for 20MHz (40MHz, 80MHz), therefore the manufacturer will control the power for 802.11n mode as same as the VHT mode and ax mode or more lower than it and investigated worst case to representative mode in test report. (Final test mode refer to section 3.2.1)

5. The above EUT information is declared by manufacturer and for more detailed features description, please refer to the manufacturer's specifications or User's Manual.
6. The above Antenna information is declared by manufacturer and for more detailed features description, please refer to the manufacturer's specifications, the laboratory shall not be held responsible.

3.2 Description of Test Modes

FOR 5180 ~ 5240MHz

4 channels are provided for 802.11a, 802.11n (HT20), 802.11ac (VHT20), 802.11ax (HE20):

Channel	Frequency	Channel	Frequency
36	5180 MHz	44	5220 MHz
40	5200 MHz	48	5240 MHz

2 channels are provided for 802.11n (HT40), 802.11ac (VHT40), 802.11ax (HE40):

Channel	Frequency	Channel	Frequency
38	5190 MHz	46	5230 MHz

1 channel is provided for 802.11ac (VHT80), 802.11ax (HE80):

Channel	Frequency
42	5210 MHz

FOR 5260 ~ 5320MHz

4 channels are provided for 802.11a, 802.11n (HT20), 802.11ac (VHT20), 802.11ax (HE20):

Channel	Frequency	Channel	Frequency
52	5260 MHz	60	5300 MHz
56	5280 MHz	64	5320 MHz

2 channels are provided for 802.11n (HT40), 802.11ac (VHT40), 802.11ax (HE40):

Channel	Frequency	Channel	Frequency
54	5270 MHz	62	5310 MHz

1 channel is provided for 802.11ac (VHT80), 802.11ax (HE80):

Channel	Frequency
58	5290 MHz

FOR 5500 ~ 5720MHz

12 channels are provided for 802.11a, 802.11n (HT20), 802.11ac (VHT20), 802.11ax (HE20):

Channel	Frequency	Channel	Frequency
100	5500 MHz	124	5620 MHz
104	5520 MHz	128	5640 MHz
108	5540 MHz	132	5660 MHz
112	5560 MHz	136	5680 MHz
116	5580 MHz	140	5700 MHz
120	5600 MHz	144	5720 MHz

6 channels are provided for 802.11n (HT40), 802.11ac (VHT40), 802.11ax (HE40):

Channel	Frequency	Channel	Frequency
102	5510 MHz	126	5630 MHz
110	5550 MHz	134	5670 MHz
118	5590 MHz	142	5710 MHz

3 channels are provided for 802.11ac (VHT80), 802.11ax (HE80):

Channel	Frequency	Channel	Frequency
106	5530 MHz	138	5690 MHz
122	5610 MHz		

FOR 5745 ~ 5825MHz:

5 channels are provided for 802.11a, 802.11n (HT20), 802.11ac (VHT20), 802.11ax (HE20):

Channel	Frequency	Channel	Frequency
149	5745 MHz	161	5805 MHz
153	5765 MHz	165	5825 MHz
157	5785 MHz		

2 channels are provided for 802.11n (HT40), 802.11ac (VHT40), 802.11ax (HE40):

Channel	Frequency	Channel	Frequency
151	5755 MHz	159	5795 MHz

1 channel is provided for 802.11ac (VHT80), 802.11ax (HE80):

Channel	Frequency
155	5775 MHz

3.2.1 Test Mode Applicability and Tested Channel Detail

EUT Configure Mode	Applicable To				Description
	RE \geq 1G	RE<1G	PLC	APCM	
1	√	√	√	√	2TX
2	√	√	-	√	1TX

Where **RE \geq 1G**: Radiated Emission above 1GHz

RE<1G: Radiated Emission below 1GHz

PLC: Power Line Conducted Emission

APCM: Antenna Port Conducted Measurement

Note: 1. The EUT's PIFA antenna had been pre-tested on the positioned of each 3 axis. The worst case was found when positioned on **X-plane**.

2. For 20MHz bandwidth, 40MHz bandwidth and 80MHz bandwidth of RU mode, the worst case was found in 20MHz bandwidth. Therefore only the test data of the mode was recorded in this report.

Radiated Emission Test (Above 1GHz):

- Pre-Scan has been conducted to determine the worst-case mode from all possible combinations between available modulations, data rates and antenna ports (if EUT with antenna diversity architecture).
- Following channel(s) was (were) selected for the final test as listed below.

2TX (CDD Mode)							
Mode	FREQ. Band (MHz)	Available Channel	Tested Channel	Modulation Technology	Modulation Type	Data Rate Parameter	RU Configuration
802.11a	5180-5320	36 to 64	36, 40, 48, 52, 60, 64	OFDM	BPSK	6Mb/s	-
802.11ax (HE20)		36 to 64	36, 40, 48, 52, 60, 64	OFDMA	BPSK	MCS0	-
802.11ax (HE40)		38 to 62	38, 46, 54, 62	OFDMA	BPSK	MCS0	-
802.11ax (HE80)		42, 58	42, 58	OFDMA	BPSK	MCS0	-
802.11a	5500-5720	100 to 144	100, 116, 140, 144	OFDM	BPSK	6Mb/s	-
802.11ax (HE20)		100 to 144	100, 116, 140, 144	OFDMA	BPSK	MCS0	-
802.11ax (HE40)		102 to 142	102, 110, 134, 142	OFDMA	BPSK	MCS0	-
802.11ax (HE80)		106 to 138	106, 122, 138	OFDMA	BPSK	MCS0	-
802.11a	5745-5825	149 to 165	149, 157, 165	OFDM	BPSK	6Mb/s	-
802.11ax (HE20)		149 to 165	149, 157, 165	OFDMA	BPSK	MCS0	-
802.11ax (HE40)		151 to 159	151, 159	OFDMA	BPSK	MCS0	-
802.11ax (HE80)		155	155	OFDMA	BPSK	MCS0	-
802.11ax (RU26)	5180-5240	36 to 48	36, 40, 48	OFDMA	BPSK	MCS0	26/0, 26/4, 26/8
	5260-5320	52 to 64	52, 60, 64	OFDMA	BPSK	MCS0	26/0, 26/4, 26/8
	5500-5720	100 to 144	100, 116, 140, 144	OFDMA	BPSK	MCS0	26/0, 26/4, 26/8, 26/8
	5745-5825	149 to 165	149, 157, 165	OFDMA	BPSK	MCS0	26/0, 26/4, 26/8
802.11ax (RU52)	5180-5240	36 to 48	36, 40, 48	OFDMA	BPSK	MCS0	52/37, 52/39, 52/40
	5260-5320	52 to 64	52, 60, 64	OFDMA	BPSK	MCS0	52/37, 52/39, 52/40
	5500-5720	100 to 144	100, 116, 140, 144	OFDMA	BPSK	MCS0	52/37, 52/39, 52/40, 52/40
	5745-5825	149 to 165	149, 157, 165	OFDMA	BPSK	MCS0	52/37, 52/39, 52/40
802.11ax (RU106)	5180-5240	36 to 48	36, 40, 48	OFDMA	BPSK	MCS0	106/53, 106/53, 106/54
	5260-5320	52 to 64	52, 60, 64	OFDMA	BPSK	MCS0	106/53, 106/54, 106/54
	5500-5720	100 to 144	100, 116, 140, 144	OFDMA	BPSK	MCS0	106/53, 106/53, 106/54, 106/54
	5745-5825	149 to 165	149, 157, 165	OFDMA	BPSK	MCS0	106/53, 106/54, 106/54

1TX							
Mode	FREQ. Band (MHz)	Available Channel	Tested Channel	Modulation Technology	Modulation Type	Data Rate Parameter	RU Configuration
802.11a	5180-5320	36 to 64	36, 40, 48, 52, 60, 64	OFDM	BPSK	6Mb/s	-
802.11ax (HE20)		36 to 64	36, 40, 48, 52, 60, 64	OFDMA	BPSK	MCS0	-
802.11ax (HE40)		38 to 62	38, 46, 54, 62	OFDMA	BPSK	MCS0	-
802.11ax (HE80)		42, 58	42, 58	OFDMA	BPSK	MCS0	-
802.11a	5500-5720	100 to 144	100, 116, 140, 144	OFDM	BPSK	6Mb/s	-
802.11ax (HE20)		100 to 144	100, 116, 140, 144	OFDMA	BPSK	MCS0	-
802.11ax (HE40)		102 to 142	102, 110, 134, 142	OFDMA	BPSK	MCS0	-
802.11ax (HE80)		106 to 138	106, 122, 138	OFDMA	BPSK	MCS0	-
802.11a	5745-5825	149 to 165	149, 157, 165	OFDM	BPSK	6Mb/s	-
802.11ax (HE20)		149 to 165	149, 157, 165	OFDMA	BPSK	MCS0	-
802.11ax (HE40)		151 to 159	151, 159	OFDMA	BPSK	MCS0	-
802.11ax (HE80)		155	155	OFDMA	BPSK	MCS0	-
802.11ax (RU26)	5180-5240	36 to 48	36, 40, 48	OFDMA	BPSK	MCS0	26/0, 26/4, 26/8
	5260-5320	52 to 64	52, 60, 64	OFDMA	BPSK	MCS0	26/0, 26/4, 26/8
	5500-5720	100 to 144	100, 116, 140, 144	OFDMA	BPSK	MCS0	26/0, 26/4, 26/8, 26/8
	5745-5825	149 to 165	149, 157, 165	OFDMA	BPSK	MCS0	26/0, 26/4, 26/8
802.11ax (RU52)	5180-5240	36 to 48	36, 40, 48	OFDMA	BPSK	MCS0	52/37, 52/39, 52/40
	5260-5320	52 to 64	52, 60, 64	OFDMA	BPSK	MCS0	52/37, 52/39, 52/40
	5500-5720	100 to 144	100, 116, 140, 144	OFDMA	BPSK	MCS0	52/37, 52/39, 52/40, 52/40
	5745-5825	149 to 165	149, 157, 165	OFDMA	BPSK	MCS0	52/37, 52/39, 52/40
802.11ax (RU106)	5180-5240	36 to 48	36, 40, 48	OFDMA	BPSK	MCS0	106/53, 106/53, 106/54
	5260-5320	52 to 64	52, 60, 64	OFDMA	BPSK	MCS0	106/53, 106/54, 106/54
	5500-5720	100 to 144	100, 116, 140, 144	OFDMA	BPSK	MCS0	106/53, 106/53, 106/54, 106/54
	5745-5825	149 to 165	149, 157, 165	OFDMA	BPSK	MCS0	106/53, 106/54, 106/54

Radiated Emission Test (Below 1GHz):

- Pre-Scan has been conducted to determine the worst-case mode from all possible combinations between available modulations, data rates and antenna ports (if EUT with antenna diversity architecture).
- Following channel(s) was (were) selected for the final test as listed below.

2TX (CDD Mode) & 1TX						
Mode	FREQ. Band (MHz)	Available Channel	Tested Channel	Modulation Technology	Modulation Type	Data Rate Parameter
802.11a	5180-5320, 5500-5720, 5745-5825	36 to 64, 100 to 144, 149 to 165	157	OFDMA	BPSK	MCS0

Power Line Conducted Emission Test:

- Pre-Scan has been conducted to determine the worst-case mode from all possible combinations between available modulations, data rates and antenna ports (if EUT with antenna diversity architecture).
- Following channel(s) was (were) selected for the final test as listed below.

2TX (CDD Mode)						
Mode	FREQ. Band (MHz)	Available Channel	Tested Channel	Modulation Technology	Modulation Type	Data Rate (Mbps)
802.11a	5180-5320, 5500-5720, 5745-5825	36 to 64, 100 to 144, 149 to 165	157	OFDMA	BPSK	MCS0

Antenna Port Conducted Measurement:

- This item includes all test value of each mode, but only includes spectrum plot of worst value of each mode.
- Pre-Scan has been conducted to determine the worst-case mode from all possible combinations between available modulations, data rates and antenna ports (if EUT with antenna diversity architecture).
- Following channel(s) was (were) selected for the final test as listed below.

2TX (CDD Mode)							
Mode	FREQ. Band (MHz)	Available Channel	Tested Channel	Modulation Technology	Modulation Type	Data Rate Parameter	RU Configuration
802.11a	5180-5320	36 to 64	36, 40, 48, 52, 60, 64	OFDM	BPSK	6Mb/s	-
802.11ac (VHT20) (Output power only)		36 to 64	36, 40, 48, 52, 60, 64	OFDM	BPSK	MCS0	-
802.11ac (VHT40) (Output power only)		38 to 62	38, 46, 54, 62	OFDM	BPSK	MCS0	-
802.11ac (VHT80) (Output power only)		42, 58	42, 58	OFDM	BPSK	MCS0	-
802.11ax (HE20)		36 to 64	36, 40, 48, 52, 60, 64	OFDMA	BPSK	MCS0	-
802.11ax (HE40)		38 to 62	38, 46, 54, 62	OFDMA	BPSK	MCS0	-
802.11ax (HE80)		42, 58	42, 58	OFDMA	BPSK	MCS0	-
802.11a	5500-5720	100 to 144	100, 116, 140, 144	OFDM	BPSK	6Mb/s	-
802.11ac (VHT20) (Output power only)		100 to 144	100, 116, 140, 144	OFDM	BPSK	MCS0	-
802.11ac (VHT40) (Output power only)		102 to 142	102, 110, 134, 142	OFDM	BPSK	MCS0	-
802.11ac (VHT80) (Output power only)		106 to 138	106, 122, 138	OFDM	BPSK	MCS0	-
802.11ax (HE20)		100 to 144	100, 116, 140, 144	OFDMA	BPSK	MCS0	-
802.11ax (HE40)		102 to 142	102, 110, 134, 142	OFDMA	BPSK	MCS0	-
802.11ax (HE80)		106 to 138	106, 122, 138	OFDMA	BPSK	MCS0	-
802.11a	5745-5825	149 to 165	149, 157, 165	OFDM	BPSK	6Mb/s	-
802.11ac (VHT20) (Output power only)		149 to 165	149, 157, 165	OFDM	BPSK	MCS0	-
802.11ac (VHT40) (Output power only)		151 to 159	151, 159	OFDM	BPSK	MCS0	-
802.11ac (VHT80) (Output power only)		155	155	OFDM	BPSK	MCS0	-
802.11ax (HE20)		149 to 165	149, 157, 165	OFDMA	BPSK	MCS0	-
802.11ax (HE40)		151 to 159	151, 159	OFDMA	BPSK	MCS0	-
802.11ax (HE80)		155	155	OFDMA	BPSK	MCS0	-

Mode	FREQ. Band (MHz)	Available Channel	Tested Channel	Modulation Technology	Modulation Type	Data Rate Parameter	RU Configuration
802.11ax (RU26)	5180-5240	36 to 48	36, 40, 48	OFDMA	BPSK	MCS0	26/0, 26/4, 26/8
	5260-5320	52 to 64	52, 60, 64	OFDMA	BPSK	MCS0	26/0, 26/4, 26/8
	5500-5720	100 to 144	100, 116, 140, 144	OFDMA	BPSK	MCS0	26/0, 26/4, 26/8, 26/8
	5745-5825	149 to 165	149, 157, 165	OFDMA	BPSK	MCS0	26/0, 26/4, 26/8
802.11ax (RU52)	5180-5240	36 to 48	36, 40, 48	OFDMA	BPSK	MCS0	52/37, 52/39, 52/40
	5260-5320	52 to 64	52, 60, 64	OFDMA	BPSK	MCS0	52/37, 52/39, 52/40
	5500-5720	100 to 144	100, 116, 140, 144	OFDMA	BPSK	MCS0	52/37, 52/39, 52/40, 52/40
	5745-5825	149 to 165	149, 157, 165	OFDMA	BPSK	MCS0	52/37, 52/39, 52/40
802.11ax (RU106)	5180-5240	36 to 48	36, 40, 48	OFDMA	BPSK	MCS0	106/53, 106/53, 106/54
	5260-5320	52 to 64	52, 60, 64	OFDMA	BPSK	MCS0	106/53, 106/54, 106/54
	5500-5720	100 to 144	100, 116, 140, 144	OFDMA	BPSK	MCS0	106/53, 106/53, 106/54, 106/54
	5745-5825	149 to 165	149, 157, 165	OFDMA	BPSK	MCS0	106/53, 106/54, 106/54
Beamforming Mode (output power only)							
Mode	FREQ. Band (MHz)	Available Channel	Tested Channel	Modulation Technology	Modulation Type	Data Rate Parameter	RU Configuration
802.11ac (VHT20)	5180-5320	36 to 64	36, 40, 48, 52, 60, 64	OFDM	BPSK	MCS0	-
802.11ac (VHT40)		36 to 64	36, 40, 48, 52, 60, 64	OFDM	BPSK	MCS0	-
802.11ac (VHT80)		38 to 62	38, 46, 54, 62	OFDM	BPSK	MCS0	-
802.11ax (HE20)		42, 58	42, 58	OFDMA	BPSK	MCS0	-
802.11ax (HE40)		36 to 64	36, 40, 48, 52, 60, 64	OFDMA	BPSK	MCS0	-
802.11ax (HE80)		38 to 62	38, 46, 54, 62	OFDMA	BPSK	MCS0	-
802.11ac (VHT20)	5500-5720	100 to 144	100, 116, 140, 144	OFDM	BPSK	MCS0	-
802.11ac (VHT40)		102 to 142	102, 110, 134, 142	OFDM	BPSK	MCS0	-
802.11ac (VHT80)		106 to 138	106, 122, 138	OFDM	BPSK	MCS0	-
802.11ax (HE20)		100 to 144	100, 116, 140, 144	OFDMA	BPSK	MCS0	-
802.11ax (HE40)		102 to 142	102, 110, 134, 142	OFDMA	BPSK	MCS0	-
802.11ax (HE80)		106 to 138	106, 122, 138	OFDMA	BPSK	MCS0	-
802.11ac (VHT20)	5745-5825	149 to 165	149, 157, 165	OFDM	BPSK	MCS0	-
802.11ac (VHT40)		151 to 159	151, 159	OFDM	BPSK	MCS0	-
802.11ac (VHT80)		155	155	OFDM	BPSK	MCS0	-
802.11ax (HE20)		149 to 165	149, 157, 165	OFDMA	BPSK	MCS0	-
802.11ax (HE40)		151 to 159	151, 159	OFDMA	BPSK	MCS0	-
802.11ax (HE80)		155	155	OFDMA	BPSK	MCS0	-

1TX							
Mode	FREQ. Band (MHz)	Available Channel	Tested Channel	Modulation Technology	Modulation Type	Data Rate Parameter	RU Configuration
802.11a	5180-5320	36 to 64	36, 40, 48, 52, 60, 64	OFDM	BPSK	6Mb/s	-
802.11ac (VHT20) (Output power only)		36 to 64	36, 40, 48, 52, 60, 64	OFDM	BPSK	MCS0	-
802.11ac (VHT40) (Output power only)		38 to 62	38, 46, 54, 62	OFDM	BPSK	MCS0	-
802.11ac (VHT80) (Output power only)		42, 58	42, 58	OFDM	BPSK	MCS0	-
802.11ax (HE20)		36 to 64	36, 40, 48, 52, 60, 64	OFDMA	BPSK	MCS0	-
802.11ax (HE40)		38 to 62	38, 46, 54, 62	OFDMA	BPSK	MCS0	-
802.11ax (HE80)		42, 58	42, 58	OFDMA	BPSK	MCS0	-
802.11a		5500-5720	100 to 144	100, 116, 140, 144	OFDM	BPSK	6Mb/s
802.11ac (VHT20) (Output power only)	100 to 144		100, 116, 140, 144	OFDM	BPSK	MCS0	-
802.11ac (VHT40) (Output power only)	102 to 142		102, 110, 134, 142	OFDM	BPSK	MCS0	-
802.11ac (VHT80) (Output power only)	106 to 138		106, 122, 138	OFDM	BPSK	MCS0	-
802.11ax (HE20)	100 to 144		100, 116, 140, 144	OFDMA	BPSK	MCS0	-
802.11ax (HE40)	102 to 142		102, 110, 134, 142	OFDMA	BPSK	MCS0	-
802.11ax (HE80)	106 to 138		106, 122, 138	OFDMA	BPSK	MCS0	-
802.11a	5745-5825	149 to 165	149, 157, 165	OFDM	BPSK	6Mb/s	-
802.11ac (VHT20) (Output power only)		149 to 165	149, 157, 165	OFDM	BPSK	MCS0	-
802.11ac (VHT40) (Output power only)		151 to 159	151, 159	OFDM	BPSK	MCS0	-
802.11ac (VHT80) (Output power only)		155	155	OFDM	BPSK	MCS0	-
802.11ax (HE20)		149 to 165	149, 157, 165	OFDMA	BPSK	MCS0	-
802.11ax (HE40)		151 to 159	151, 159	OFDMA	BPSK	MCS0	-
802.11ax (HE80)		155	155	OFDMA	BPSK	MCS0	-
802.11ax (RU26)	5180-5240	36 to 48	36, 40, 48	OFDMA	BPSK	MCS0	26/0, 26/4, 26/8
	5260-5320	52 to 64	52, 60, 64	OFDMA	BPSK	MCS0	26/0, 26/4, 26/8
	5500-5720	100 to 144	100, 116, 140, 144	OFDMA	BPSK	MCS0	26/0, 26/4, 26/8, 26/8
	5745-5825	149 to 165	149, 157, 165	OFDMA	BPSK	MCS0	26/0, 26/4, 26/8
802.11ax (RU52)	5180-5240	36 to 48	36, 40, 48	OFDMA	BPSK	MCS0	52/37, 52/39, 52/40
	5260-5320	52 to 64	52, 60, 64	OFDMA	BPSK	MCS0	52/37, 52/39, 52/40
	5500-5720	100 to 144	100, 116, 140, 144	OFDMA	BPSK	MCS0	52/37, 52/39, 52/40, 52/40
	5745-5825	149 to 165	149, 157, 165	OFDMA	BPSK	MCS0	52/37, 52/39, 52/40
802.11ax (RU106)	5180-5240	36 to 48	36, 40, 48	OFDMA	BPSK	MCS0	106/53, 106/53, 106/54
	5260-5320	52 to 64	52, 60, 64	OFDMA	BPSK	MCS0	106/53, 106/54, 106/54
	5500-5720	100 to 144	100, 116, 140, 144	OFDMA	BPSK	MCS0	106/53, 106/53, 106/54, 106/54
	5745-5825	149 to 165	149, 157, 165	OFDMA	BPSK	MCS0	106/53, 106/54, 106/54

Test Condition:

Applicable To	Environmental Conditions	Input Power (System)	Tested By
RE \geq 1G	25deg. C, 71%RH	120Vac, 60Hz	Sampson Chen
RE<1G	25deg. C, 71%RH	120Vac, 60Hz	Sampson Chen
PLC	25deg. C, 65%RH	120Vac, 60Hz	Sampson Chen
APCM	25deg. C, 60%RH	120Vac, 60Hz	Kevin Ko

3.3 Duty Cycle of Test Signal

For Mode 1:

Duty cycle of test signal is $\geq 98\%$, duty factor is not required.

802.11a: Duty cycle = 1.359 ms / 1.386 ms = 0.981

802.11ax (HE20): Duty cycle = 0.985 ms / 0.994 ms = 0.991

802.11ax (HE40): Duty cycle = 0.519 ms / 0.527 ms = 0.985

802.11ax (HE80): Duty cycle = 0.289 ms / 0.286 ms = 0.99

802.11ax (RU26): Duty cycle = 4.883 ms / 4.895 ms = 0.998

802.11ax (RU52): Duty cycle = 2.473 ms / 2.484 ms = 0.996

802.11ax (RU106): Duty cycle = 1.199 ms / 1.208 ms = 0.993

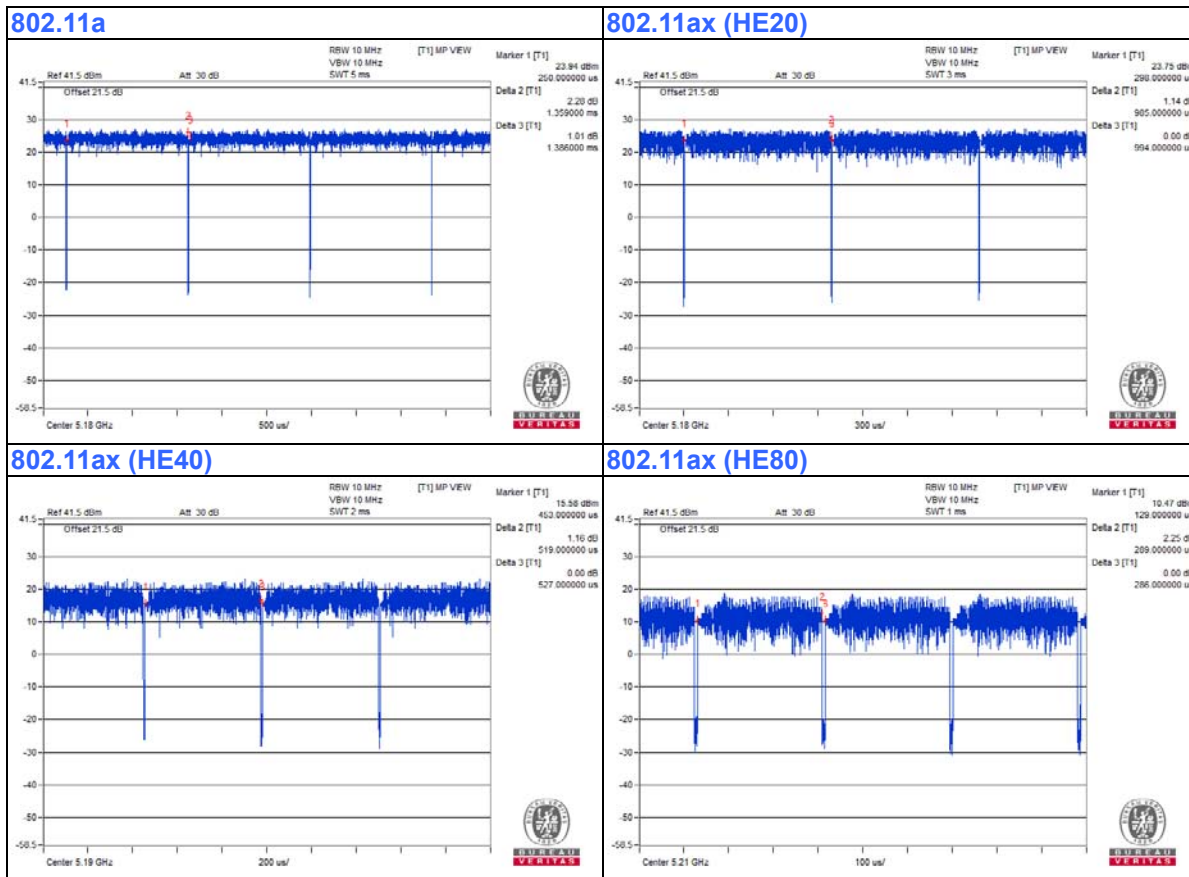

802.11ax (RU26)

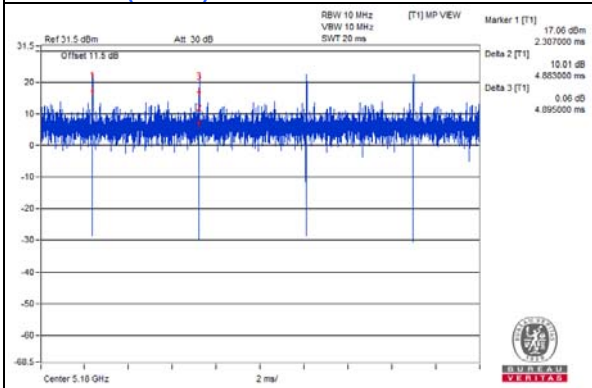

802.11ax (RU52)

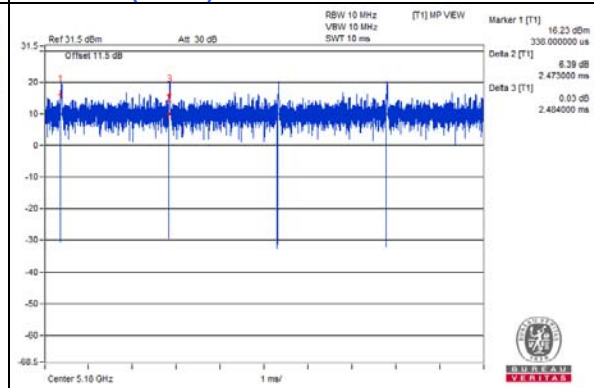

802.11ax (RU106)

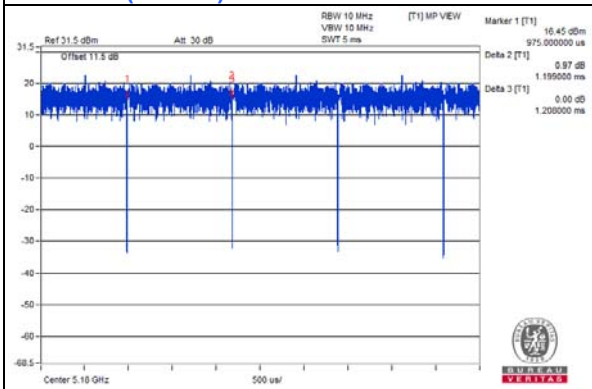

For Mode 2:
 Duty cycle of test signal is $\geq 98\%$, duty factor is not required.

- 802.11a:** Duty cycle = 1.359 ms / 1.386 ms=0.981
- 802.11ax (HE20):** Duty cycle = 0.985 ms / 0.994 ms=0.991
- 802.11ax (HE40):** Duty cycle = 0.519 ms / 0.527 ms=0.985
- 802.11ax (HE80):** Duty cycle = 0.289 ms / 0.292 ms=0.99
- 802.11ax (RU26):** Duty cycle = 4.883 ms / 4.895 ms=0.998
- 802.11ax (RU52):** Duty cycle = 2.473 ms / 2.484 ms=0.996
- 802.11ax (RU106):** Duty cycle = 1.199 ms / 1.208 ms=0.993

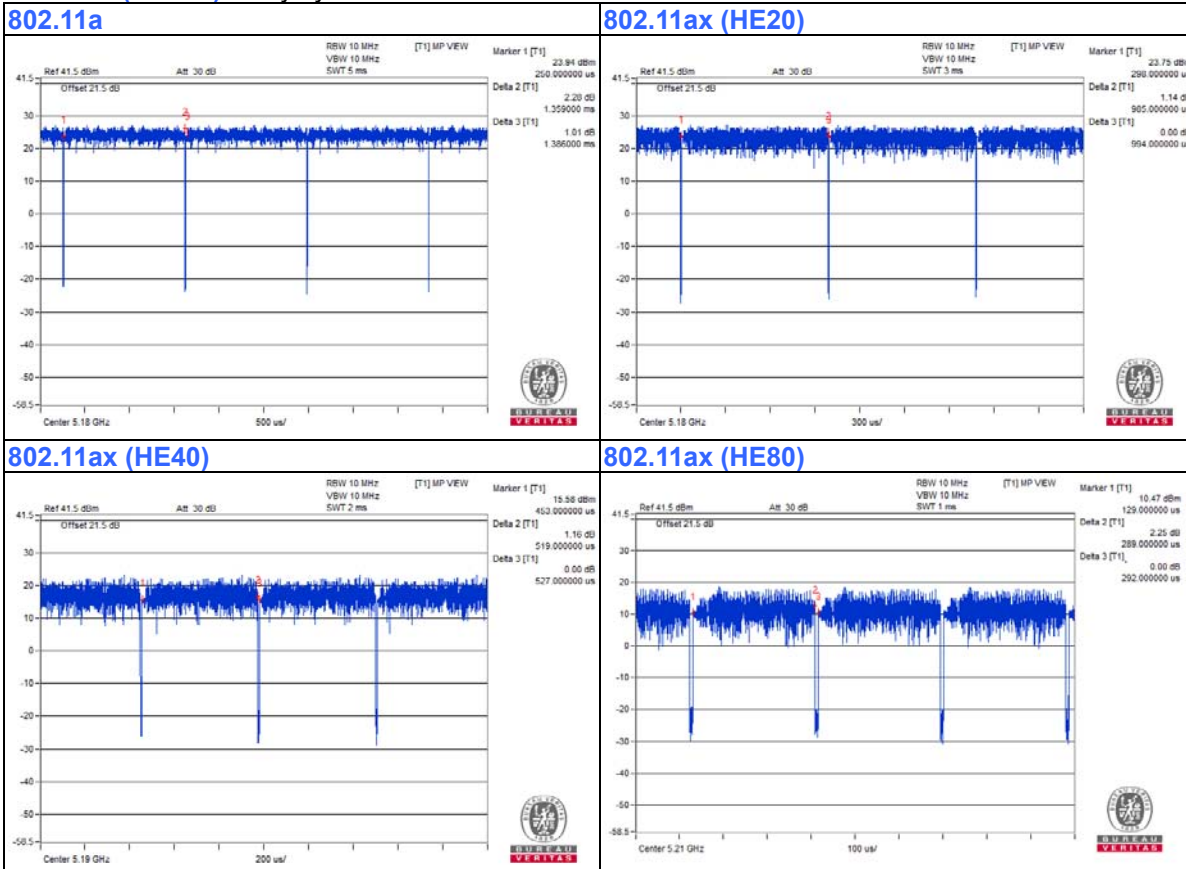

802.11ax (RU26)

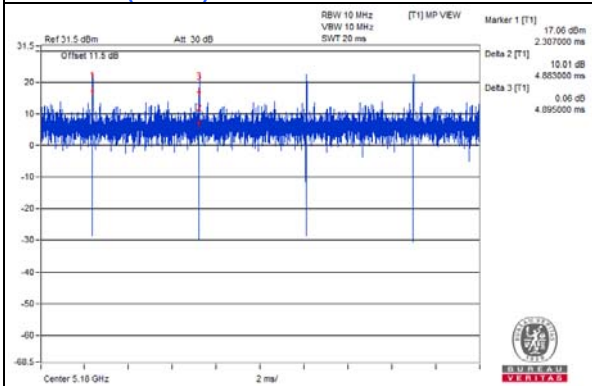

802.11ax (RU52)

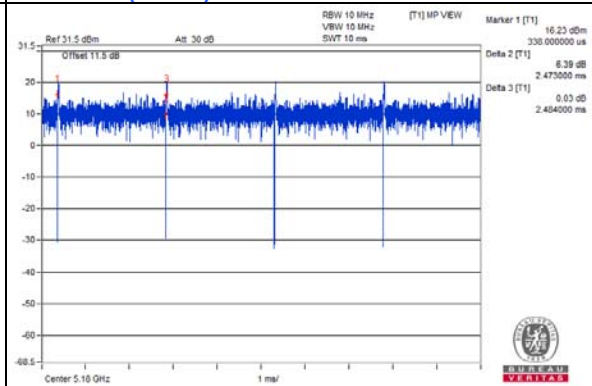

802.11ax (RU106)

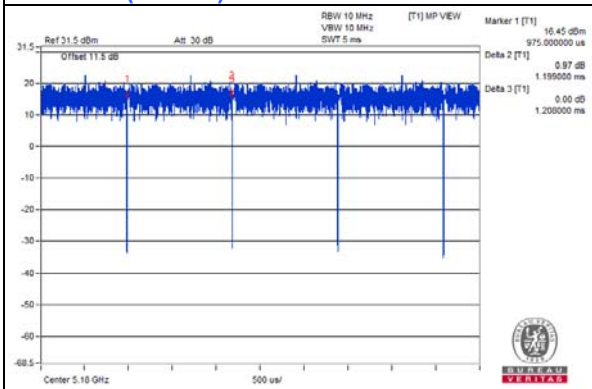

3.4 Description of Support Units

The EUT has been tested as an independent unit together with other necessary accessories or support units. The following support units or accessories were used to form a representative test configuration during the tests.

ID	Product	Brand	Model No.	Serial No.	FCC ID	Remarks
A.	Laptop	DELL	E6420	B92T3R1	FCC DoC	Provided by Lab
B.	Test Tool	Realtek	NA	NA	NA	Supplied by client
C.	Adapter	DELL	FA65NE0-00	NA	NA	Provided by Lab

Note:

1. All power cords of the above support units are non-shielded (1.8m).

ID	Descriptions	Qty.	Length (m)	Shielding (Yes/No)	Cores (Qty.)	Remarks
1.	DC Cable	1	1.8	No	1	Provided by Lab
2.	AC Cable	1	1	No	0	Provided by Lab

Note: The core(s) is(are) originally attached to the cable(s).

3.4.1 Configuration of System under Test

For AC Power Conducted Emissions test:

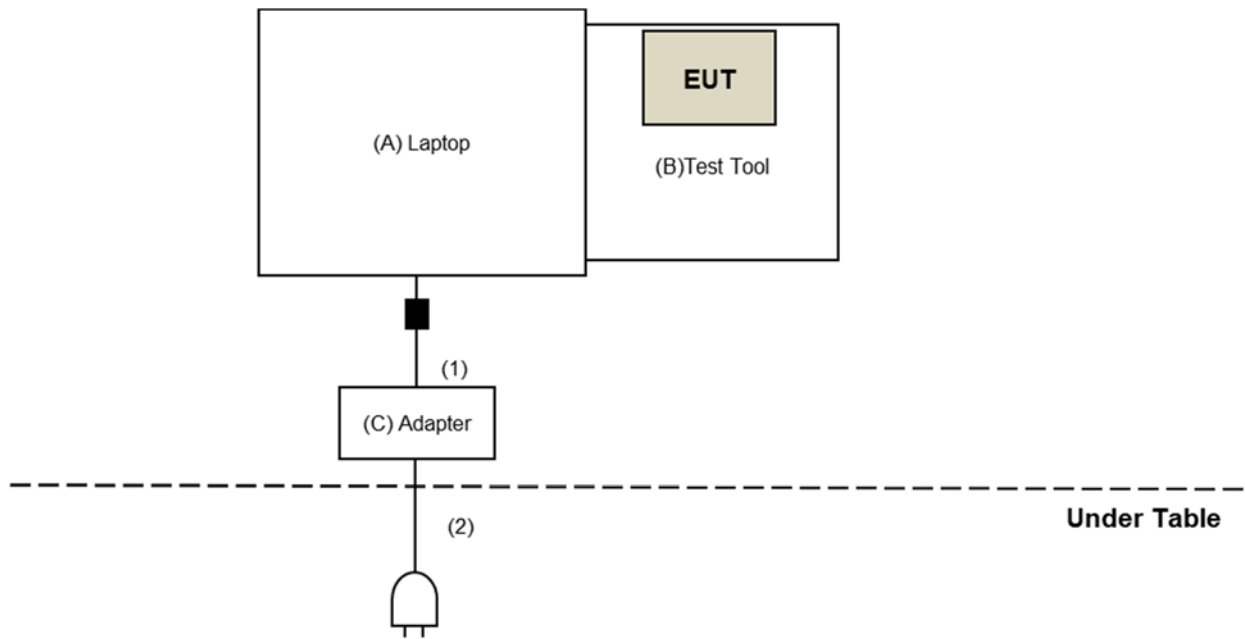

For Radiated Emissions test:

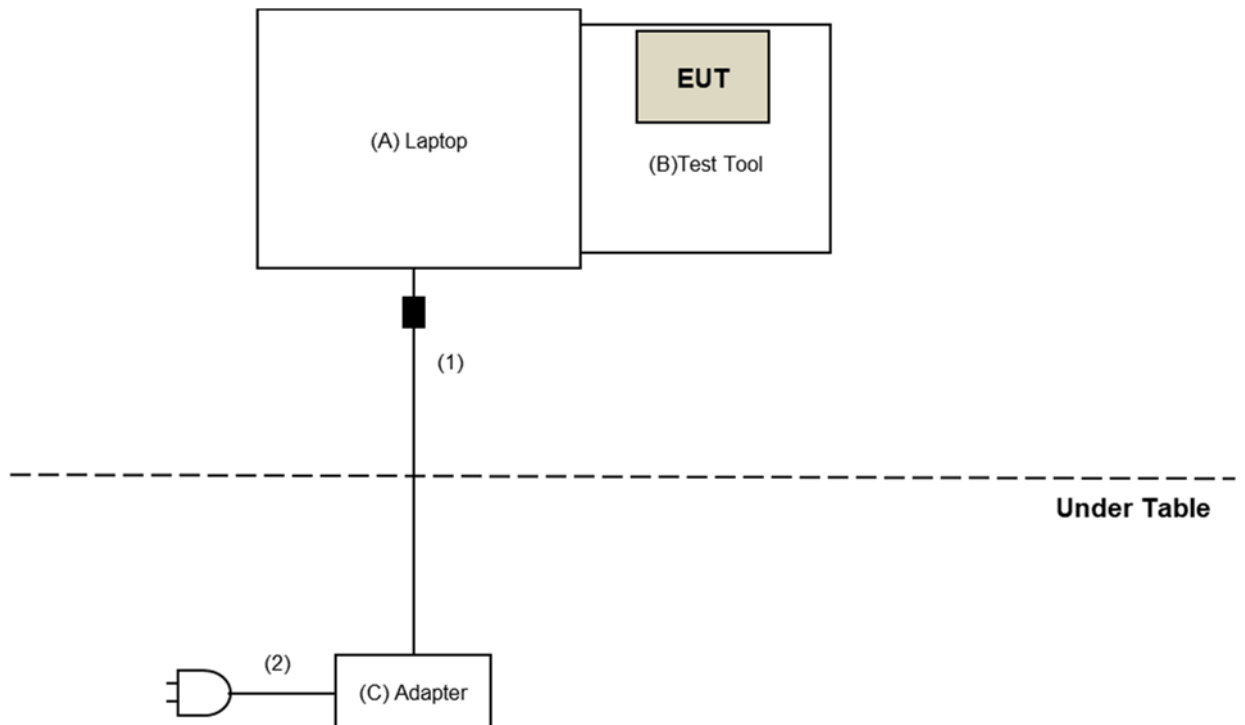

3.5 General Description of Applied Standard and References

The EUT is a RF Product. According to the specifications of the manufacturer, it must comply with the requirements of the following standards and references:

Test Standard:

FCC Part 15, Subpart E (15.407)

ANSI C63.10-2013

All test items have been performed and recorded as per the above standards.

References Test Guidance:

KDB 789033 D02 General UNII Test Procedure New Rules v02r01

KDB 662911 D01 Multiple Transmitter Output v02r01

All test items have been performed as a reference to the above KDB test guidance.

4 Test Types and Results

4.1 Radiated Emission and Bandedge Measurement

4.1.1 Limits of Radiated Emission and Bandedge Measurement

Radiated emissions which fall in the restricted bands must comply with the radiated emission limits specified as below table.

Frequencies (MHz)	Field Strength (microvolts/meter)	Measurement Distance (meters)
0.009 ~ 0.490	2400/F(kHz)	300
0.490 ~ 1.705	24000/F(kHz)	30
1.705 ~ 30.0	30	30
30 ~ 88	100	3
88 ~ 216	150	3
216 ~ 960	200	3
Above 960	500	3

NOTE:

1. The lower limit shall apply at the transition frequencies.
2. Emission level (dBuV/m) = 20 log Emission level (uV/m).
3. For frequencies above 1000MHz, the field strength limits are based on average detector, however, the peak field strength of any emission shall not exceed the maximum permitted average limits, specified above by more than 20dB under any condition of modulation.

Limits of unwanted emission out of the restricted bands

Applicable To		Limit	
789033 D02 General UNII Test Procedure New Rules v02r01		Field Strength at 3m	
		PK:74 (dBuV/m)	AV:54 (dBuV/m)
Frequency Band	Applicable To	EIRP Limit	Equivalent Field Strength at 3m
5150~5250 MHz	15.407(b)(1)	PK:-27 (dBm/MHz)	PK:68.2(dBuV/m)
5250~5350 MHz	15.407(b)(2)		
5470~5725 MHz	15.407(b)(3)		
5725~5850 MHz	15.407(b)(4)(i)	PK:-27 (dBm/MHz) ^{*1} PK:10 (dBm/MHz) ^{*2} PK:15.6 (dBm/MHz) ^{*3} PK:27 (dBm/MHz) ^{*4}	PK: 68.2(dBuV/m) ^{*1} PK:105.2 (dBuV/m) ^{*2} PK: 110.8(dBuV/m) ^{*3} PK:122.2 (dBuV/m) ^{*4}
^{*1} beyond 75 MHz or more above of the band edge.		^{*2} below the band edge increasing linearly to 10 dBm/MHz at 25 MHz above.	
^{*3} below the band edge increasing linearly to a level of 15.6 dBm/MHz at 5 MHz above.		^{*4} from 5 MHz above or below the band edge increasing linearly to a level of 27 dBm/MHz at the band edge.	

Note:

The following formula is used to convert the equipment isotropic radiated power (eirp) to field strength:

$$E = \frac{1000000}{3} \sqrt{30 P} \quad \mu\text{V/m, where P is the eirp (Watts).}$$

4.1.2 Test Instruments

For Radiated Emission (above 1GHz), OOBE and Bandedge test:

DESCRIPTION & MANUFACTURER	MODEL NO.	SERIAL NO.	CALIBRATED DATE	CALIBRATED UNTIL
Test Receiver R&S	ESR3	102528	Mar. 02, 2021	Mar. 01, 2022
Spectrum Analyzer Keysight	N9030B	MY57142938	Apr. 26, 2021	Apr. 25, 2022
Horn_Antenna SCHWARZBECK	BBHA 9120D	9120D-1819	Nov. 22, 2020	Nov. 21, 2021
Pre-Amplifier EMCI	EMC12630SE	980509	Apr. 26, 2021	Apr. 25, 2022
RF Cable EMCI	EMC104-SM-SM-1500	180503	Apr. 26, 2021	Apr. 25, 2022
RF Cable EMCI	EMC104-SM-SM-2000	180501	Apr. 26, 2021	Apr. 25, 2022
RF Cable EMCI	EMC104-SM-SM-6000	180506	Apr. 26, 2021	Apr. 25, 2022
Pre-Amplifier EMCI	EMC184045SE	980387	Jan. 11, 2021	Jan. 10, 2022
Horn_Antenna SCHWARZBECK	BBHA 9170	BBHA9170519	Nov. 22, 2020	Nov. 21, 2021
RF Cable	EMC102-KM-KM-1200	160924	Jan. 11, 2021	Jan. 10, 2022
RF Cable	EMC-KM-KM-4000	200214	Mar. 10, 2021	Mar. 09, 2022
Software	ADT_Radiated_V8.7.08	NA	NA	NA
Boresight Antenna Tower & Turn Table Max-Full	MF-7802BS	MF780208530	NA	NA

Note:

1. The calibration interval of the above test instruments is 12 months and the calibrations are traceable to NML/ROC and NIST/USA.
2. The test was performed in 966 Chamber No. 5.
3. Tested Date: May 20 to July 05, 2021

For Radiated Emission (below 1GHz) test:

DESCRIPTION & MANUFACTURER	MODEL NO.	SERIAL NO.	CALIBRATED DATE	CALIBRATED UNTIL
Test Receiver R&S	ESR3	102528	Mar. 02, 2021	Mar. 01, 2022
Spectrum Analyzer Keysight	N9030B	MY57142938	Apr. 26, 2021	Apr. 25, 2022
Pre-Amplifier EMCi	EMC001340	980142	May 24, 2021	May 23, 2022
Loop Antenna Electro-Metrics	EM-6879	264	Mar. 05, 2021	Mar. 04, 2022
RF Cable	5D-FB	LOOPCAB-001	Jan. 07, 2021	Jan. 06, 2022
RF Cable	5D-FB	LOOPCAB-002	Jan. 07, 2021	Jan. 06, 2022
Pre-Amplifier EMCi	EMC330N	980538	Apr. 26, 2021	Apr. 25, 2022
Trilog Broadband Antenna SCHWARZBECK	VULB9168	9168-0842	Nov. 03, 2020	Nov. 02, 2021
RF Cable	8D	966-5-1	Apr. 26, 2021	Apr. 25, 2022
RF Cable	8D	966-5-2	Apr. 26, 2021	Apr. 25, 2022
RF Cable	8D	966-5-3	Apr. 26, 2021	Apr. 25, 2022
Fixed attenuator Mini-Circuits	UNAT-5+	PAD-ATT5-02	Jan. 11, 2021	Jan. 10, 2022
Software	ADT_Radiated_V8.7.08	NA	NA	NA
Boresight Antenna Tower & Turn Table Max-Full	MF-7802BS	MF780208530	NA	NA

Note:

1. The calibration interval of the above test instruments is 12 months and the calibrations are traceable to NML/ROC and NIST/USA.
2. The test was performed in 966 Chamber No. 5.
3. Tested Date: June 19, 2021

For other test items:

DESCRIPTION & MANUFACTURER	MODEL NO.	SERIAL NO.	CALIBRATED DATE	CALIBRATED UNTIL
Spectrum Analyzer R&S	FSV40	100964	Mar. 08, 2021	Mar. 07, 2022
Power meter Anritsu	ML2495A	1529002	June 21, 2021	June 20, 2022
Power sensor Anritsu	MA2411B	1339443	May 31, 2021	May 30, 2022
Fixed Attenuator Mini-Circuits	MDCS18N-10	MDCS18N-10-01	Apr. 13, 2021	Apr. 12, 2022
DC Power Supply Topward	6603D	795558	NA	NA
Temperature & Humidity Chamber Giant Force	GTH-150-40-SP-AR	MAA0812-008	Jan. 14, 2021	Jan. 13, 2022
True RMS Clamp Meter FLUKE	325	31130711WS	June 02, 2021	June 01, 2022
Software	ADT_RF Test Software V6.6.5.4	NA	NA	NA

- NOTE:**
1. The test was performed in Oven room 2.
 2. The calibration interval of the above test instruments is 12 months and the calibrations are traceable to NML/ROC and NIST/USA.
 3. Tested Date: July 05 to 13, 2021

4.1.3 Test Procedure

For Radiated emission below 30MHz

- a. The EUT was placed on the top of a rotating table 0.8 meters above the ground at a 3 meter chamber room. The table was rotated 360 degrees to determine the position of the highest radiation.
- b. The EUT was set 3 meters away from the interference-receiving antenna, which was mounted on the top of a variable-height antenna tower.
- c. Parallel, perpendicular, and ground-parallel orientations of the antenna are set to make the measurement.
- d. For each suspected emission, the EUT was arranged to its worst case and the rotatable table was turned from 0 degrees to 360 degrees to find the maximum reading.
- e. The test-receiver system was set to Quasi-Peak Detect Function and Specified Bandwidth with Maximum Hold Mode.

Note:

1. The resolution bandwidth and video bandwidth of test receiver/spectrum analyzer is 9kHz at frequency below 30MHz.

For Radiated emission above 30MHz

- a. The EUT was placed on the top of a rotating table 0.8 meters (for 30MHz ~ 1GHz) / 1.5 meters (for above 1GHz) above the ground at 3 meter chamber room for test. The table was rotated 360 degrees to determine the position of the highest radiation.
- b. The EUT was set 3 meters away from the interference-receiving antenna, which was mounted on the top of a variable-height antenna tower.
- c. The height of antenna is varied from one meter to four meters above the ground to determine the maximum value of the field strength. Both horizontal and vertical polarizations of the antenna are set to make the measurement.
- d. For each suspected emission, the EUT was arranged to its worst case and then the antenna was tuned to heights from 1 meter to 4 meters and the rotatable table was turned from 0 degrees to 360 degrees to find the maximum reading.
- e. The test-receiver system was set to quasi-peak detect function and specified bandwidth with maximum hold mode when the test frequency is below 1 GHz.
- f. The test-receiver system was set to peak and average detects function and specified bandwidth with maximum hold mode when the test frequency is above 1 GHz. If the peak reading value also meets average limit, measurement with the average detector is unnecessary.

Note:

1. The resolution bandwidth and video bandwidth of test receiver/spectrum analyzer is 120kHz for Quasi-peak detection (QP) at frequency below 1GHz.
2. The resolution bandwidth of test receiver/spectrum analyzer is 1 MHz and the video bandwidth is 3 MHz for Peak detection (PK) at frequency above 1GHz.
3. The resolution bandwidth of test receiver/spectrum analyzer is 1MHz and the video bandwidth is $\geq 1/T$ (Duty cycle $< 98\%$) or 10Hz (Duty cycle $\geq 98\%$) for Average detection (AV) at frequency above 1GHz.
4. All modes of operation were investigated and the worst-case emissions are reported.

4.1.4 Deviation from Test Standard

No deviation.

4.1.5 Test Setup

For Radiated emission below 30MHz

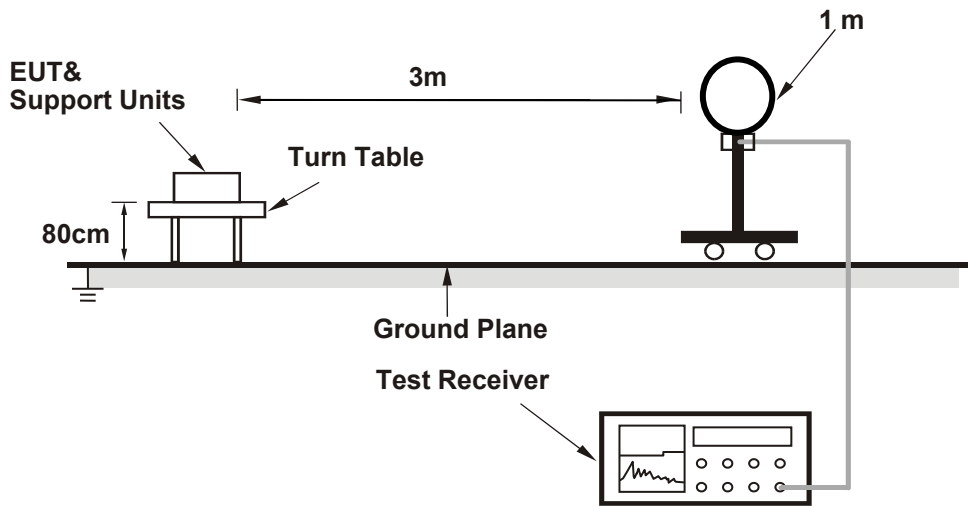

For Radiated emission 30MHz to 1GHz

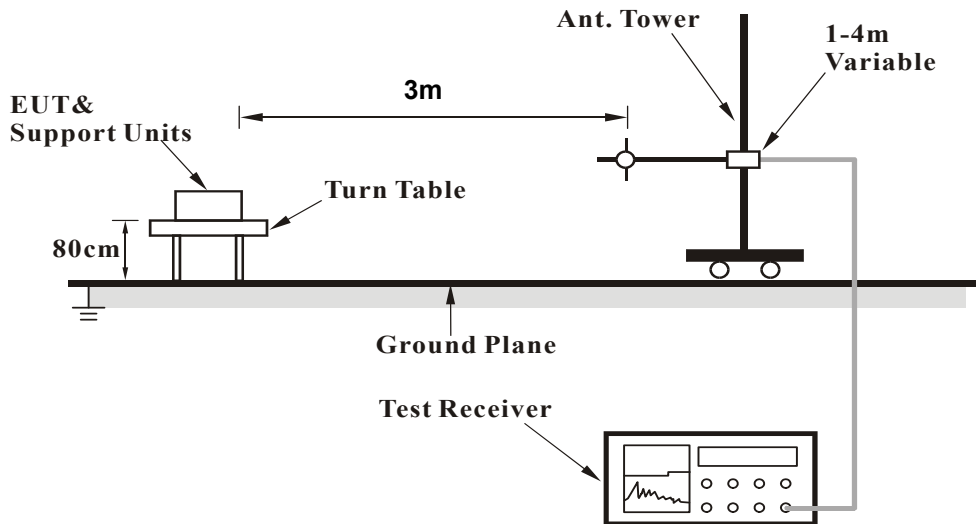

For Radiated emission above 1GHz

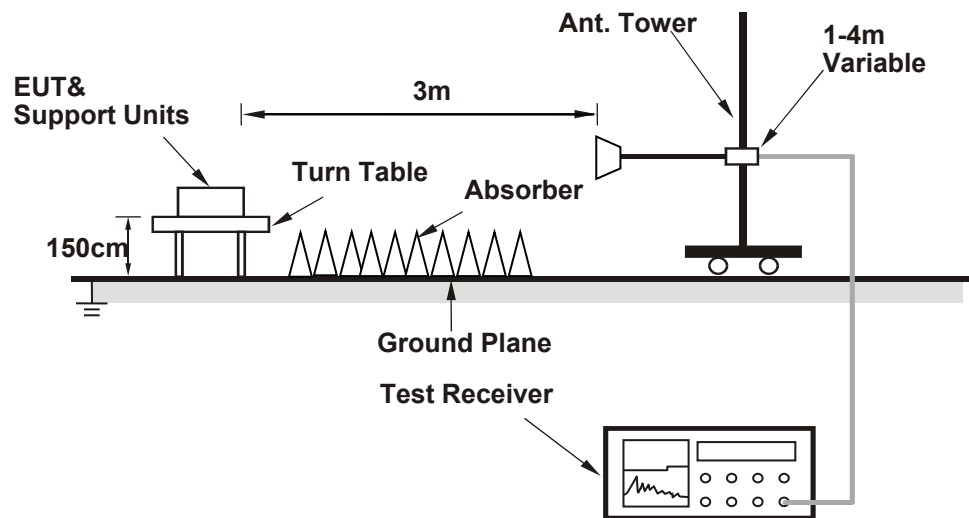

For the actual test configuration, please refer to the attached file (Test Setup Photo).

4.1.6 EUT Operating Condition

- a. Connected the EUT with the Laptop which is placed on the testing table.
- b. Controlling software (RTL8852B MP Toolkit V1.0.16) has been activated to set the EUT under transmission condition continuously.

4.1.7 Test Results (Mode 1)

Dipole Antenna
Above 1GHz Data:

RF Mode	TX 802.11a	Channel	CH 36 : 5180 MHz
Frequency Range	1GHz ~ 40GHz	Detector Function	Peak (PK) Average (AV)

Antenna Polarity & Test Distance : Horizontal at 3 m								
No	Frequency (MHz)	Emission Level (dBuV/m)	Limit (dBuV/m)	Margin (dB)	Antenna Height (m)	Table Angle (Degree)	Raw Value (dBuV)	Correction Factor (dB/m)
1	5150.00	59.0 PK	74.0	-15.0	1.37 H	129	56.7	2.3
2	5150.00	44.0 AV	54.0	-10.0	1.37 H	129	41.7	2.3
3	*5180.00	107.5 PK			1.37 H	129	105.3	2.2
4	*5180.00	98.0 AV			1.37 H	129	95.8	2.2
5	#10360.00	51.3 PK	68.2	-16.9	2.78 H	152	39.5	11.8
6	15540.00	57.6 PK	74.0	-16.4	1.48 H	352	45.8	11.8
7	15540.00	44.3 AV	54.0	-9.7	1.48 H	352	32.5	11.8
Antenna Polarity & Test Distance : Vertical at 3 m								
No	Frequency (MHz)	Emission Level (dBuV/m)	Limit (dBuV/m)	Margin (dB)	Antenna Height (m)	Table Angle (Degree)	Raw Value (dBuV)	Correction Factor (dB/m)
1	5150.00	65.0 PK	74.0	-9.0	1.35 V	277	62.7	2.3
2	5150.00	52.4 AV	54.0	-1.6	1.35 V	277	50.1	2.3
3	*5180.00	118.8 PK			1.35 V	277	116.6	2.2
4	*5180.00	109.2 AV			1.35 V	277	107.0	2.2
5	#10360.00	52.3 PK	68.2	-15.9	3.01 V	162	40.5	11.8
6	15540.00	59.4 PK	74.0	-14.6	3.74 V	291	47.6	11.8
7	15540.00	45.1 AV	54.0	-8.9	3.74 V	291	33.3	11.8

Remarks:

1. Emission Level(dBuV/m) = Raw Value(dBuV) + Correction Factor(dB/m)
2. Correction Factor(dB/m) = Antenna Factor(dB/m) + Cable Factor(dB) – Pre-Amplifier Factor(dB)
3. Margin value = Emission Level – Limit value
4. The other emission levels were very low against the limit.
5. " * ": Fundamental frequency.
6. " # ": The radiated frequency is out of the restricted band.

RF Mode	TX 802.11a	Channel	CH 40 : 5200 MHz
Frequency Range	1GHz ~ 40GHz	Detector Function	Peak (PK) Average (AV)

Antenna Polarity & Test Distance : Horizontal at 3 m

No	Frequency (MHz)	Emission Level (dBuV/m)	Limit (dBuV/m)	Margin (dB)	Antenna Height (m)	Table Angle (Degree)	Raw Value (dBuV)	Correction Factor (dB/m)
1	5150.00	58.4 PK	74.0	-15.6	1.32 H	143	56.1	2.3
2	5150.00	41.8 AV	54.0	-12.2	1.32 H	143	39.5	2.3
3	*5200.00	108.4 PK			1.32 H	143	106.3	2.1
4	*5200.00	99.2 AV			1.32 H	143	97.1	2.1
5	#10400.00	50.6 PK	68.2	-17.6	2.82 H	132	38.6	12.0
6	15600.00	57.4 PK	74.0	-16.6	1.47 H	357	45.9	11.5
7	15600.00	44.2 AV	54.0	-9.8	1.47 H	357	32.7	11.5

Antenna Polarity & Test Distance : Vertical at 3 m

No	Frequency (MHz)	Emission Level (dBuV/m)	Limit (dBuV/m)	Margin (dB)	Antenna Height (m)	Table Angle (Degree)	Raw Value (dBuV)	Correction Factor (dB/m)
1	5150.00	61.4 PK	74.0	-12.6	1.51 V	281	59.1	2.3
2	5150.00	43.7 AV	54.0	-10.3	1.51 V	281	41.4	2.3
3	*5200.00	119.5 PK			1.51 V	281	117.4	2.1
4	*5200.00	110.1 AV			1.51 V	281	108.0	2.1
5	#10400.00	52.4 PK	68.2	-15.8	3.05 V	166	40.4	12.0
6	15600.00	58.6 PK	74.0	-15.4	3.80 V	289	47.1	11.5
7	15600.00	44.7 AV	54.0	-9.3	3.80 V	289	33.2	11.5

Remarks:

1. Emission Level(dBuV/m) = Raw Value(dBuV) + Correction Factor(dB/m)
2. Correction Factor(dB/m) = Antenna Factor(dB/m) + Cable Factor(dB) – Pre-Amplifier Factor(dB)
3. Margin value = Emission Level – Limit value
4. The other emission levels were very low against the limit.
5. " * ": Fundamental frequency.
6. " # ": The radiated frequency is out of the restricted band.

RF Mode	TX 802.11a	Channel	CH 48 : 5240 MHz
Frequency Range	1GHz ~ 40GHz	Detector Function	Peak (PK) Average (AV)

Antenna Polarity & Test Distance : Horizontal at 3 m

No	Frequency (MHz)	Emission Level (dBuV/m)	Limit (dBuV/m)	Margin (dB)	Antenna Height (m)	Table Angle (Degree)	Raw Value (dBuV)	Correction Factor (dB/m)
1	5150.00	51.9 PK	74.0	-22.1	1.32 H	129	49.6	2.3
2	5150.00	38.8 AV	54.0	-15.2	1.32 H	129	36.5	2.3
3	*5240.00	108.6 PK			1.32 H	129	106.6	2.0
4	*5240.00	99.3 AV			1.32 H	129	97.3	2.0
5	5350.00	51.2 PK	74.0	-22.8	1.32 H	129	49.3	1.9
6	5350.00	38.2 AV	54.0	-15.8	1.32 H	129	36.3	1.9
7	#10480.00	50.4 PK	68.2	-17.8	2.80 H	156	38.5	11.9
8	15720.00	57.5 PK	74.0	-16.5	1.47 H	345	45.7	11.8
9	15720.00	44.4 AV	54.0	-9.6	1.47 H	345	32.6	11.8

Antenna Polarity & Test Distance : Vertical at 3 m

No	Frequency (MHz)	Emission Level (dBuV/m)	Limit (dBuV/m)	Margin (dB)	Antenna Height (m)	Table Angle (Degree)	Raw Value (dBuV)	Correction Factor (dB/m)
1	5150.00	52.5 PK	74.0	-21.5	1.48 V	275	50.2	2.3
2	5150.00	39.6 AV	54.0	-14.4	1.48 V	275	37.3	2.3
3	*5240.00	119.4 PK			1.48 V	275	117.4	2.0
4	*5240.00	109.9 AV			1.48 V	275	107.9	2.0
5	5350.00	51.5 PK	74.0	-22.5	1.48 V	275	49.6	1.9
6	5350.00	38.4 AV	54.0	-15.6	1.48 V	275	36.5	1.9
7	#10480.00	52.8 PK	68.2	-15.4	3.00 V	173	40.9	11.9
8	15720.00	58.7 PK	74.0	-15.3	3.80 V	290	46.9	11.8
9	15720.00	44.6 AV	54.0	-9.4	3.80 V	290	32.8	11.8

Remarks:

1. Emission Level(dBuV/m) = Raw Value(dBuV) + Correction Factor(dB/m)
2. Correction Factor(dB/m) = Antenna Factor(dB/m) + Cable Factor(dB) – Pre-Amplifier Factor(dB)
3. Margin value = Emission Level – Limit value
4. The other emission levels were very low against the limit.
5. " * ": Fundamental frequency.
6. " # ": The radiated frequency is out of the restricted band.

RF Mode	TX 802.11a	Channel	CH 52 : 5260 MHz
Frequency Range	1GHz ~ 40GHz	Detector Function	Peak (PK) Average (AV)

Antenna Polarity & Test Distance : Horizontal at 3 m

No	Frequency (MHz)	Emission Level (dBuV/m)	Limit (dBuV/m)	Margin (dB)	Antenna Height (m)	Table Angle (Degree)	Raw Value (dBuV)	Correction Factor (dB/m)
1	5150.00	51.8 PK	74.0	-22.2	1.31 H	124	49.5	2.3
2	5150.00	38.4 AV	54.0	-15.6	1.31 H	124	36.1	2.3
3	*5260.00	108.9 PK			1.31 H	124	106.9	2.0
4	*5260.00	99.4 AV			1.31 H	124	97.4	2.0
5	5350.00	50.1 PK	74.0	-23.9	1.31 H	124	48.2	1.9
6	5350.00	37.6 AV	54.0	-16.4	1.31 H	124	35.7	1.9
7	#10520.00	50.8 PK	68.2	-17.4	2.81 H	159	38.8	12.0
8	15780.00	57.5 PK	74.0	-16.5	1.46 H	329	46.0	11.5
9	15780.00	44.8 AV	54.0	-9.2	1.46 H	329	33.3	11.5

Antenna Polarity & Test Distance : Vertical at 3 m

No	Frequency (MHz)	Emission Level (dBuV/m)	Limit (dBuV/m)	Margin (dB)	Antenna Height (m)	Table Angle (Degree)	Raw Value (dBuV)	Correction Factor (dB/m)
1	5150.00	52.4 PK	74.0	-21.6	1.34 V	280	50.1	2.3
2	5150.00	39.5 AV	54.0	-14.5	1.34 V	280	37.2	2.3
3	*5260.00	119.9 PK			1.34 V	280	117.9	2.0
4	*5260.00	110.1 AV			1.34 V	280	108.1	2.0
5	5350.00	51.2 PK	74.0	-22.8	1.34 V	280	49.3	1.9
6	5350.00	38.7 AV	54.0	-15.3	1.34 V	280	36.8	1.9
7	#10520.00	53.3 PK	68.2	-14.9	3.58 V	188	41.3	12.0
8	15780.00	59.9 PK	74.0	-14.1	3.60 V	280	48.4	11.5
9	15780.00	45.3 AV	54.0	-8.7	3.60 V	280	33.8	11.5

Remarks:

1. Emission Level(dBuV/m) = Raw Value(dBuV) + Correction Factor(dB/m)
2. Correction Factor(dB/m) = Antenna Factor(dB/m) + Cable Factor(dB) – Pre-Amplifier Factor(dB)
3. Margin value = Emission Level – Limit value
4. The other emission levels were very low against the limit.
5. " * ": Fundamental frequency.
6. " # ": The radiated frequency is out of the restricted band.

RF Mode	TX 802.11a	Channel	CH 60 : 5300 MHz
Frequency Range	1GHz ~ 40GHz	Detector Function	Peak (PK) Average (AV)

Antenna Polarity & Test Distance : Horizontal at 3 m								
No	Frequency (MHz)	Emission Level (dBuV/m)	Limit (dBuV/m)	Margin (dB)	Antenna Height (m)	Table Angle (Degree)	Raw Value (dBuV)	Correction Factor (dB/m)
1	*5300.00	108.1 PK			1.34 H	117	106.4	1.7
2	*5300.00	99.1 AV			1.34 H	117	97.4	1.7
3	5350.00	55.3 PK	74.0	-18.7	1.34 H	117	53.4	1.9
4	5350.00	40.9 AV	54.0	-13.1	1.34 H	117	39.0	1.9
5	10600.00	50.7 PK	74.0	-23.3	2.74 H	135	38.8	11.9
6	10600.00	40.6 AV	54.0	-13.4	2.74 H	135	28.7	11.9
7	15900.00	57.4 PK	74.0	-16.6	1.49 H	342	46.1	11.3
8	15900.00	44.6 AV	54.0	-9.4	1.49 H	342	33.3	11.3

Antenna Polarity & Test Distance : Vertical at 3 m								
No	Frequency (MHz)	Emission Level (dBuV/m)	Limit (dBuV/m)	Margin (dB)	Antenna Height (m)	Table Angle (Degree)	Raw Value (dBuV)	Correction Factor (dB/m)
1	*5300.00	119.1 PK			1.32 V	283	117.4	1.7
2	*5300.00	109.7 AV			1.32 V	283	108.0	1.7
3	5350.00	64.1 PK	74.0	-9.9	1.32 V	283	62.2	1.9
4	5350.00	44.4 AV	54.0	-9.6	1.32 V	283	42.5	1.9
5	10600.00	53.3 PK	74.0	-20.7	3.60 V	182	41.4	11.9
6	10600.00	40.6 AV	54.0	-13.4	3.60 V	182	28.7	11.9
7	15900.00	59.7 PK	74.0	-14.3	3.66 V	293	48.4	11.3
8	15900.00	45.1 AV	54.0	-8.9	3.66 V	293	33.8	11.3

Remarks:

1. Emission Level(dBuV/m) = Raw Value(dBuV) + Correction Factor(dB/m)
2. Correction Factor(dB/m) = Antenna Factor(dB/m) + Cable Factor(dB) – Pre-Amplifier Factor(dB)
3. Margin value = Emission Level – Limit value
4. The other emission levels were very low against the limit.
5. " * ": Fundamental frequency.

RF Mode	TX 802.11a	Channel	CH 64 : 5320 MHz
Frequency Range	1GHz ~ 40GHz	Detector Function	Peak (PK) Average (AV)

Antenna Polarity & Test Distance : Horizontal at 3 m

No	Frequency (MHz)	Emission Level (dBuV/m)	Limit (dBuV/m)	Margin (dB)	Antenna Height (m)	Table Angle (Degree)	Raw Value (dBuV)	Correction Factor (dB/m)
1	*5320.00	106.2 PK			1.70 H	136	104.4	1.8
2	*5320.00	96.9 AV			1.70 H	136	95.1	1.8
3	5350.00	57.0 PK	74.0	-17.0	1.70 H	136	55.1	1.9
4	5350.00	41.0 AV	54.0	-13.0	1.70 H	136	39.1	1.9
5	10640.00	50.5 PK	74.0	-23.5	2.85 H	140	38.7	11.8
6	10640.00	40.3 AV	54.0	-13.7	2.85 H	140	28.5	11.8
7	15960.00	57.5 PK	74.0	-16.5	1.49 H	332	45.9	11.6
8	15960.00	44.4 AV	54.0	-9.6	1.49 H	332	32.8	11.6

Antenna Polarity & Test Distance : Vertical at 3 m

No	Frequency (MHz)	Emission Level (dBuV/m)	Limit (dBuV/m)	Margin (dB)	Antenna Height (m)	Table Angle (Degree)	Raw Value (dBuV)	Correction Factor (dB/m)
1	*5320.00	118.2 PK			1.41 V	288	116.4	1.8
2	*5320.00	108.6 AV			1.41 V	288	106.8	1.8
3	5350.00	72.5 PK	74.0	-1.5	1.41 V	288	70.6	1.9
4	5350.00	52.5 AV	54.0	-1.5	1.41 V	288	50.6	1.9
5	10640.00	53.4 PK	74.0	-20.6	3.55 V	194	41.6	11.8
6	10640.00	40.9 AV	54.0	-13.1	3.55 V	194	29.1	11.8
7	15960.00	59.7 PK	74.0	-14.3	3.66 V	283	48.1	11.6
8	15960.00	44.9 AV	54.0	-9.1	3.66 V	283	33.3	11.6

Remarks:

1. Emission Level(dBuV/m) = Raw Value(dBuV) + Correction Factor(dB/m)
2. Correction Factor(dB/m) = Antenna Factor(dB/m) + Cable Factor(dB) – Pre-Amplifier Factor(dB)
3. Margin value = Emission Level – Limit value
4. The other emission levels were very low against the limit.
5. " * ": Fundamental frequency.

RF Mode	TX 802.11a	Channel	CH 100 : 5500 MHz
Frequency Range	1GHz ~ 40GHz	Detector Function	Peak (PK) Average (AV)

Antenna Polarity & Test Distance : Horizontal at 3 m								
No	Frequency (MHz)	Emission Level (dBuV/m)	Limit (dBuV/m)	Margin (dB)	Antenna Height (m)	Table Angle (Degree)	Raw Value (dBuV)	Correction Factor (dB/m)
1	5460.00	51.8 PK	74.0	-22.2	1.35 H	139	49.7	2.1
2	5460.00	38.2 AV	54.0	-15.8	1.35 H	139	36.1	2.1
3	#5470.00	53.2 PK	68.2	-15.0	1.35 H	139	51.0	2.2
4	*5500.00	103.1 PK			1.35 H	139	101.0	2.1
5	*5500.00	94.3 AV			1.35 H	139	92.2	2.1
6	11000.00	50.7 PK	74.0	-23.3	2.76 H	150	38.3	12.4
7	11000.00	40.0 AV	54.0	-14.0	2.76 H	150	27.6	12.4
8	#16500.00	56.7 PK	68.2	-11.5	1.47 H	331	43.0	13.7

Antenna Polarity & Test Distance : Vertical at 3 m								
No	Frequency (MHz)	Emission Level (dBuV/m)	Limit (dBuV/m)	Margin (dB)	Antenna Height (m)	Table Angle (Degree)	Raw Value (dBuV)	Correction Factor (dB/m)
1	5460.00	59.9 PK	74.0	-14.1	1.43 V	272	57.8	2.1
2	5460.00	44.1 AV	54.0	-9.9	1.43 V	272	42.0	2.1
3	#5466.45	66.3 PK	68.2	-1.9	1.43 V	272	64.2	2.1
4	*5500.00	116.9 PK			1.43 V	272	114.8	2.1
5	*5500.00	106.8 AV			1.43 V	272	104.7	2.1
6	11000.00	55.4 PK	74.0	-18.6	3.95 V	174	43.0	12.4
7	11000.00	42.8 AV	54.0	-11.2	3.95 V	174	30.4	12.4
8	#16500.00	62.9 PK	68.2	-5.3	2.05 V	292	49.2	13.7

Remarks:

1. Emission Level(dBuV/m) = Raw Value(dBuV) + Correction Factor(dB/m)
2. Correction Factor(dB/m) = Antenna Factor(dB/m) + Cable Factor(dB) – Pre-Amplifier Factor(dB)
3. Margin value = Emission Level – Limit value
4. The other emission levels were very low against the limit.
5. " * ": Fundamental frequency.
6. " # ": The radiated frequency is out of the restricted band.

RF Mode	TX 802.11a	Channel	CH 116 : 5580 MHz
Frequency Range	1GHz ~ 40GHz	Detector Function	Peak (PK) Average (AV)

Antenna Polarity & Test Distance : Horizontal at 3 m								
No	Frequency (MHz)	Emission Level (dBuV/m)	Limit (dBuV/m)	Margin (dB)	Antenna Height (m)	Table Angle (Degree)	Raw Value (dBuV)	Correction Factor (dB/m)
1	5460.00	52.1 PK	74.0	-21.9	1.35 H	135	50.0	2.1
2	5460.00	41.3 AV	54.0	-12.7	1.35 H	135	39.2	2.1
3	#5470.00	53.8 PK	68.2	-14.4	1.35 H	135	51.6	2.2
4	*5580.00	108.3 PK			1.35 H	135	106.2	2.1
5	*5580.00	99.2 AV			1.35 H	135	97.1	2.1
6	11160.00	50.7 PK	74.0	-23.3	2.79 H	146	38.7	12.0
7	11160.00	40.3 AV	54.0	-13.7	2.79 H	146	28.3	12.0
8	#16740.00	57.3 PK	68.2	-10.9	1.50 H	344	42.0	15.3

Antenna Polarity & Test Distance : Vertical at 3 m								
No	Frequency (MHz)	Emission Level (dBuV/m)	Limit (dBuV/m)	Margin (dB)	Antenna Height (m)	Table Angle (Degree)	Raw Value (dBuV)	Correction Factor (dB/m)
1	5460.00	53.8 PK	74.0	-20.2	1.35 V	274	51.7	2.1
2	5460.00	42.4 AV	54.0	-11.6	1.35 V	274	40.3	2.1
3	#5470.00	55.6 PK	68.2	-12.6	1.35 V	274	53.4	2.2
4	*5580.00	119.4 PK			1.35 V	274	117.3	2.1
5	*5580.00	109.7 AV			1.35 V	274	107.6	2.1
6	11160.00	55.3 PK	74.0	-18.7	3.97 V	159	43.3	12.0
7	11160.00	43.0 AV	54.0	-11.0	3.97 V	159	31.0	12.0
8	#16740.00	62.8 PK	68.2	-5.4	2.08 V	278	47.5	15.3

Remarks:

1. Emission Level(dBuV/m) = Raw Value(dBuV) + Correction Factor(dB/m)
2. Correction Factor(dB/m) = Antenna Factor(dB/m) + Cable Factor(dB) – Pre-Amplifier Factor(dB)
3. Margin value = Emission Level – Limit value
4. The other emission levels were very low against the limit.
5. " * ": Fundamental frequency.
6. " # ": The radiated frequency is out of the restricted band.

RF Mode	TX 802.11a	Channel	CH 140 : 5700 MHz
Frequency Range	1GHz ~ 40GHz	Detector Function	Peak (PK) Average (AV)

Antenna Polarity & Test Distance : Horizontal at 3 m

No	Frequency (MHz)	Emission Level (dBuV/m)	Limit (dBuV/m)	Margin (dB)	Antenna Height (m)	Table Angle (Degree)	Raw Value (dBuV)	Correction Factor (dB/m)
1	*5700.00	105.3 PK			1.32 H	135	103.0	2.3
2	*5700.00	94.6 AV			1.32 H	135	92.3	2.3
3	#5725.00	54.8 PK	68.2	-13.4	1.32 H	135	52.4	2.4
4	11400.00	50.1 PK	74.0	-23.9	2.75 H	158	37.6	12.5
5	11400.00	39.8 AV	54.0	-14.2	2.75 H	158	27.3	12.5
6	#17100.00	57.3 PK	68.2	-10.9	1.44 H	339	40.5	16.8

Antenna Polarity & Test Distance : Vertical at 3 m

No	Frequency (MHz)	Emission Level (dBuV/m)	Limit (dBuV/m)	Margin (dB)	Antenna Height (m)	Table Angle (Degree)	Raw Value (dBuV)	Correction Factor (dB/m)
1	*5700.00	114.4 PK			1.48 V	270	112.1	2.3
2	*5700.00	105.6 AV			1.48 V	270	103.3	2.3
3	#5725.00	66.5 PK	68.2	-1.7	1.48 V	270	64.1	2.4
4	11400.00	56.0 PK	74.0	-18.0	3.94 V	151	43.5	12.5
5	11400.00	43.5 AV	54.0	-10.5	3.94 V	151	31.0	12.5
6	#17100.00	62.3 PK	68.2	-5.9	2.07 V	265	45.5	16.8

Remarks:

1. Emission Level(dBuV/m) = Raw Value(dBuV) + Correction Factor(dB/m)
2. Correction Factor(dB/m) = Antenna Factor(dB/m) + Cable Factor(dB) – Pre-Amplifier Factor(dB)
3. Margin value = Emission Level – Limit value
4. The other emission levels were very low against the limit.
5. " * " : Fundamental frequency.
6. " # " : The radiated frequency is out of the restricted band.

RF Mode	TX 802.11a	Channel	CH 144 : 5720 MHz
Frequency Range	1GHz ~ 40GHz	Detector Function	Peak (PK) Average (AV)

Antenna Polarity & Test Distance : Horizontal at 3 m

No	Frequency (MHz)	Emission Level (dBuV/m)	Limit (dBuV/m)	Margin (dB)	Antenna Height (m)	Table Angle (Degree)	Raw Value (dBuV)	Correction Factor (dB/m)
1	5460.00	51.2 PK	74.0	-22.8	1.30 H	125	49.1	2.1
2	5460.00	39.8 AV	54.0	-14.2	1.30 H	125	37.7	2.1
3	#5470.00	51.8 PK	68.2	-16.4	1.30 H	125	49.6	2.2
4	*5720.00	108.5 PK			1.30 H	125	106.1	2.4
5	*5720.00	99.3 AV			1.30 H	125	96.9	2.4
6	#5850.00	53.1 PK	68.2	-15.1	1.30 H	125	50.4	2.7
7	11440.00	50.4 PK	74.0	-23.6	2.83 H	138	38.0	12.4
8	11440.00	40.2 AV	54.0	-13.8	2.83 H	138	27.8	12.4
9	#17160.00	56.5 PK	68.2	-11.7	1.52 H	342	39.9	16.6

Antenna Polarity & Test Distance : Vertical at 3 m

No	Frequency (MHz)	Emission Level (dBuV/m)	Limit (dBuV/m)	Margin (dB)	Antenna Height (m)	Table Angle (Degree)	Raw Value (dBuV)	Correction Factor (dB/m)
1	5460.00	51.7 PK	74.0	-22.3	1.36 V	299	49.6	2.1
2	5460.00	39.8 AV	54.0	-14.2	1.36 V	299	37.7	2.1
3	#5470.00	52.0 PK	68.2	-16.2	1.36 V	299	49.8	2.2
4	*5720.00	119.3 PK			1.36 V	299	116.9	2.4
5	*5720.00	110.0 AV			1.36 V	299	107.6	2.4
6	#5850.00	53.5 PK	68.2	-14.7	1.36 V	299	50.8	2.7
7	11440.00	55.1 PK	74.0	-18.9	3.96 V	165	42.7	12.4
8	11440.00	42.6 AV	54.0	-11.4	3.96 V	165	30.2	12.4
9	#17160.00	62.3 PK	68.2	-5.9	2.05 V	286	45.7	16.6

Remarks:

1. Emission Level(dBuV/m) = Raw Value(dBuV) + Correction Factor(dB/m)
2. Correction Factor(dB/m) = Antenna Factor(dB/m) + Cable Factor(dB) – Pre-Amplifier Factor(dB)
3. Margin value = Emission Level – Limit value
4. The other emission levels were very low against the limit.
5. " * ": Fundamental frequency.
6. " # ": The radiated frequency is out of the restricted band.

RF Mode	TX 802.11a	Channel	CH 149 : 5745 MHz
Frequency Range	1GHz ~ 40GHz	Detector Function	Peak (PK) Average (AV)

Antenna Polarity & Test Distance : Horizontal at 3 m								
No	Frequency (MHz)	Emission Level (dBuV/m)	Limit (dBuV/m)	Margin (dB)	Antenna Height (m)	Table Angle (Degree)	Raw Value (dBuV)	Correction Factor (dB/m)
1	#5560.33	49.8 PK	68.2	-18.4	1.52 H	146	47.7	2.1
2	*5745.00	108.0 PK			1.52 H	146	105.6	2.4
3	*5745.00	97.6 AV			1.52 H	146	95.2	2.4
4	#5996.71	50.8 PK	68.2	-17.4	1.52 H	146	47.9	2.9
5	11490.00	53.7 PK	74.0	-20.3	1.33 H	320	41.1	12.6
6	11490.00	42.2 AV	54.0	-11.8	1.33 H	320	29.6	12.6
7	#17235.00	56.8 PK	68.2	-11.4	3.55 H	315	40.0	16.8

Antenna Polarity & Test Distance : Vertical at 3 m								
No	Frequency (MHz)	Emission Level (dBuV/m)	Limit (dBuV/m)	Margin (dB)	Antenna Height (m)	Table Angle (Degree)	Raw Value (dBuV)	Correction Factor (dB/m)
1	#5615.98	52.1 PK	68.2	-16.1	1.52 V	274	50.0	2.1
2	*5745.00	118.0 PK			1.52 V	274	115.6	2.4
3	*5745.00	109.0 AV			1.52 V	274	106.6	2.4
4	#5963.17	51.6 PK	68.2	-16.6	1.52 V	274	48.7	2.9
5	11490.00	55.5 PK	74.0	-18.5	1.22 V	304	42.9	12.6
6	11490.00	43.3 AV	54.0	-10.7	1.22 V	304	30.7	12.6
7	#17235.00	58.0 PK	68.2	-10.2	1.23 V	338	41.2	16.8

Remarks:

1. Emission Level(dBuV/m) = Raw Value(dBuV) + Correction Factor(dB/m)
2. Correction Factor(dB/m) = Antenna Factor(dB/m) + Cable Factor(dB) – Pre-Amplifier Factor(dB)
3. Margin value = Emission Level – Limit value
4. The other emission levels were very low against the limit.
5. " * ": Fundamental frequency.
6. " # ": The radiated frequency is out of the restricted band.

RF Mode	TX 802.11a	Channel	CH 157 : 5785 MHz
Frequency Range	1GHz ~ 40GHz	Detector Function	Peak (PK) Average (AV)

Antenna Polarity & Test Distance : Horizontal at 3 m

No	Frequency (MHz)	Emission Level (dBuV/m)	Limit (dBuV/m)	Margin (dB)	Antenna Height (m)	Table Angle (Degree)	Raw Value (dBuV)	Correction Factor (dB/m)
1	#5635.62	50.5 PK	68.2	-17.7	1.49 H	141	48.2	2.3
2	*5785.00	108.2 PK			1.49 H	141	105.6	2.6
3	*5785.00	97.8 AV			1.49 H	141	95.2	2.6
4	#6017.28	50.8 PK	68.2	-17.4	1.49 H	141	47.9	2.9
5	11570.00	54.2 PK	74.0	-19.8	1.32 H	322	41.6	12.6
6	11570.00	42.4 AV	54.0	-11.6	1.32 H	322	29.8	12.6
7	#17355.00	57.1 PK	68.2	-11.1	3.56 H	312	39.4	17.7

Antenna Polarity & Test Distance : Vertical at 3 m

No	Frequency (MHz)	Emission Level (dBuV/m)	Limit (dBuV/m)	Margin (dB)	Antenna Height (m)	Table Angle (Degree)	Raw Value (dBuV)	Correction Factor (dB/m)
1	#5565.85	51.3 PK	68.2	-16.9	1.55 V	280	49.2	2.1
2	*5785.00	117.7 PK			1.55 V	280	115.1	2.6
3	*5785.00	108.9 AV			1.55 V	280	106.3	2.6
4	#5975.89	52.8 PK	68.2	-15.4	1.55 V	280	49.9	2.9
5	11570.00	55.1 PK	74.0	-18.9	1.25 V	307	42.5	12.6
6	11570.00	43.1 AV	54.0	-10.9	1.25 V	307	30.5	12.6
7	#17355.00	58.2 PK	68.2	-10.0	1.21 V	358	40.5	17.7

Remarks:

1. Emission Level(dBuV/m) = Raw Value(dBuV) + Correction Factor(dB/m)
2. Correction Factor(dB/m) = Antenna Factor(dB/m) + Cable Factor(dB) – Pre-Amplifier Factor(dB)
3. Margin value = Emission Level – Limit value
4. The other emission levels were very low against the limit.
5. " * ": Fundamental frequency.
6. " # ": The radiated frequency is out of the restricted band.

RF Mode	TX 802.11a	Channel	CH 165 : 5825 MHz
Frequency Range	1GHz ~ 40GHz	Detector Function	Peak (PK) Average (AV)

Antenna Polarity & Test Distance : Horizontal at 3 m

No	Frequency (MHz)	Emission Level (dBuV/m)	Limit (dBuV/m)	Margin (dB)	Antenna Height (m)	Table Angle (Degree)	Raw Value (dBuV)	Correction Factor (dB/m)
1	#5561.21	50.0 PK	68.2	-18.2	1.56 H	149	47.9	2.1
2	*5825.00	107.9 PK			1.56 H	149	105.3	2.6
3	*5825.00	97.7 AV			1.56 H	149	95.1	2.6
4	#5973.06	50.9 PK	68.2	-17.3	1.56 H	149	48.0	2.9
5	11650.00	53.6 PK	74.0	-20.4	1.30 H	328	41.4	12.2
6	11650.00	42.1 AV	54.0	-11.9	1.30 H	328	29.9	12.2
7	#17475.00	57.3 PK	68.2	-10.9	3.59 H	315	38.6	18.7

Antenna Polarity & Test Distance : Vertical at 3 m

No	Frequency (MHz)	Emission Level (dBuV/m)	Limit (dBuV/m)	Margin (dB)	Antenna Height (m)	Table Angle (Degree)	Raw Value (dBuV)	Correction Factor (dB/m)
1	#5594.92	50.5 PK	68.2	-17.7	1.49 V	281	48.4	2.1
2	*5825.00	118.1 PK			1.49 V	281	115.5	2.6
3	*5825.00	109.1 AV			1.49 V	281	106.5	2.6
4	#5930.62	56.2 PK	68.2	-12.0	1.49 V	281	53.3	2.9
5	11650.00	55.3 PK	74.0	-18.7	1.25 V	317	43.1	12.2
6	11650.00	43.2 AV	54.0	-10.8	1.25 V	317	31.0	12.2
7	#17475.00	58.9 PK	68.2	-9.3	1.26 V	353	40.2	18.7

Remarks:

1. Emission Level(dBuV/m) = Raw Value(dBuV) + Correction Factor(dB/m)
2. Correction Factor(dB/m) = Antenna Factor(dB/m) + Cable Factor(dB) – Pre-Amplifier Factor(dB)
3. Margin value = Emission Level – Limit value
4. The other emission levels were very low against the limit.
5. " * ": Fundamental frequency.
6. " # ": The radiated frequency is out of the restricted band.

RF Mode	TX 802.11ax (HE20)	Channel	CH 36 : 5180 MHz
Frequency Range	1GHz ~ 40GHz	Detector Function	Peak (PK) Average (AV)

Antenna Polarity & Test Distance : Horizontal at 3 m								
No	Frequency (MHz)	Emission Level (dBuV/m)	Limit (dBuV/m)	Margin (dB)	Antenna Height (m)	Table Angle (Degree)	Raw Value (dBuV)	Correction Factor (dB/m)
1	5150.00	54.9 PK	74.0	-19.1	1.35 H	123	52.6	2.3
2	5150.00	43.7 AV	54.0	-10.3	1.35 H	123	41.4	2.3
3	*5180.00	106.5 PK			1.35 H	123	104.3	2.2
4	*5180.00	95.7 AV			1.35 H	123	93.5	2.2
5	#10360.00	51.5 PK	68.2	-16.7	2.75 H	160	39.7	11.8
6	15540.00	57.2 PK	74.0	-16.8	1.47 H	348	45.4	11.8
7	15540.00	43.9 AV	54.0	-10.1	1.47 H	348	32.1	11.8

Antenna Polarity & Test Distance : Vertical at 3 m								
No	Frequency (MHz)	Emission Level (dBuV/m)	Limit (dBuV/m)	Margin (dB)	Antenna Height (m)	Table Angle (Degree)	Raw Value (dBuV)	Correction Factor (dB/m)
1	5150.00	65.4 PK	74.0	-8.6	1.39 V	277	63.1	2.3
2	5150.00	52.3 AV	54.0	-1.7	1.39 V	277	50.0	2.3
3	*5180.00	119.2 PK			1.39 V	277	117.0	2.2
4	*5180.00	108.3 AV			1.39 V	277	106.1	2.2
5	#10360.00	51.9 PK	68.2	-16.3	3.02 V	162	40.1	11.8
6	15540.00	59.1 PK	74.0	-14.9	3.73 V	291	47.3	11.8
7	15540.00	44.7 AV	54.0	-9.3	3.73 V	291	32.9	11.8

Remarks:

1. Emission Level(dBuV/m) = Raw Value(dBuV) + Correction Factor(dB/m)
2. Correction Factor(dB/m) = Antenna Factor(dB/m) + Cable Factor(dB) – Pre-Amplifier Factor(dB)
3. Margin value = Emission Level – Limit value
4. The other emission levels were very low against the limit.
5. " * ": Fundamental frequency.
6. " # ": The radiated frequency is out of the restricted band.

RF Mode	TX 802.11ax (HE20)	Channel	CH 40 : 5200 MHz
Frequency Range	1GHz ~ 40GHz	Detector Function	Peak (PK) Average (AV)

Antenna Polarity & Test Distance : Horizontal at 3 m

No	Frequency (MHz)	Emission Level (dBuV/m)	Limit (dBuV/m)	Margin (dB)	Antenna Height (m)	Table Angle (Degree)	Raw Value (dBuV)	Correction Factor (dB/m)
1	5150.00	53.2 PK	74.0	-20.8	1.41 H	135	50.9	2.3
2	5150.00	42.1 AV	54.0	-11.9	1.41 H	135	39.8	2.3
3	*5200.00	107.6 PK			1.41 H	135	105.5	2.1
4	*5200.00	96.9 AV			1.41 H	135	94.8	2.1
5	#10400.00	51.0 PK	68.2	-17.2	2.77 H	154	39.0	12.0
6	15600.00	57.7 PK	74.0	-16.3	1.47 H	352	46.2	11.5
7	15600.00	44.2 AV	54.0	-9.8	1.47 H	352	32.7	11.5

Antenna Polarity & Test Distance : Vertical at 3 m

No	Frequency (MHz)	Emission Level (dBuV/m)	Limit (dBuV/m)	Margin (dB)	Antenna Height (m)	Table Angle (Degree)	Raw Value (dBuV)	Correction Factor (dB/m)
1	5150.00	62.9 PK	74.0	-11.1	1.10 V	274	60.6	2.3
2	5150.00	44.9 AV	54.0	-9.1	1.10 V	274	42.6	2.3
3	*5200.00	120.5 PK			1.10 V	274	118.4	2.1
4	*5200.00	109.8 AV			1.10 V	274	107.7	2.1
5	#10400.00	52.4 PK	68.2	-15.8	2.99 V	158	40.4	12.0
6	15600.00	60.0 PK	74.0	-14.0	3.69 V	283	48.5	11.5
7	15600.00	45.4 AV	54.0	-8.6	3.69 V	283	33.9	11.5

Remarks:

1. Emission Level(dBuV/m) = Raw Value(dBuV) + Correction Factor(dB/m)
2. Correction Factor(dB/m) = Antenna Factor(dB/m) + Cable Factor(dB) – Pre-Amplifier Factor(dB)
3. Margin value = Emission Level – Limit value
4. The other emission levels were very low against the limit.
5. " * ": Fundamental frequency.
6. " # ": The radiated frequency is out of the restricted band.

RF Mode	TX 802.11ax (HE20)	Channel	CH 48 : 5240 MHz
Frequency Range	1GHz ~ 40GHz	Detector Function	Peak (PK) Average (AV)

Antenna Polarity & Test Distance : Horizontal at 3 m								
No	Frequency (MHz)	Emission Level (dBuV/m)	Limit (dBuV/m)	Margin (dB)	Antenna Height (m)	Table Angle (Degree)	Raw Value (dBuV)	Correction Factor (dB/m)
1	5150.00	50.7 PK	74.0	-23.3	1.41 H	115	48.4	2.3
2	5150.00	38.2 AV	54.0	-15.8	1.41 H	115	35.9	2.3
3	*5240.00	107.9 PK			1.41 H	115	105.9	2.0
4	*5240.00	97.1 AV			1.41 H	115	95.1	2.0
5	5350.00	51.3 PK	74.0	-22.7	1.41 H	115	49.4	1.9
6	5350.00	37.8 AV	54.0	-16.2	1.41 H	115	35.9	1.9
7	#10480.00	51.1 PK	68.2	-17.1	2.73 H	156	39.2	11.9
8	15720.00	57.6 PK	74.0	-16.4	1.43 H	339	45.8	11.8
9	15720.00	44.3 AV	54.0	-9.7	1.43 H	339	32.5	11.8

Antenna Polarity & Test Distance : Vertical at 3 m								
No	Frequency (MHz)	Emission Level (dBuV/m)	Limit (dBuV/m)	Margin (dB)	Antenna Height (m)	Table Angle (Degree)	Raw Value (dBuV)	Correction Factor (dB/m)
1	5150.00	51.7 PK	74.0	-22.3	1.48 V	276	49.4	2.3
2	5150.00	39.8 AV	54.0	-14.2	1.48 V	276	37.5	2.3
3	*5240.00	121.1 PK			1.48 V	276	119.1	2.0
4	*5240.00	109.9 AV			1.48 V	276	107.9	2.0
5	5350.00	52.0 PK	74.0	-22.0	1.48 V	276	50.1	1.9
6	5350.00	38.7 AV	54.0	-15.3	1.48 V	276	36.8	1.9
7	#10480.00	51.7 PK	68.2	-16.5	2.98 V	155	39.8	11.9
8	15720.00	60.0 PK	74.0	-14.0	3.72 V	286	48.2	11.8
9	15720.00	45.6 AV	54.0	-8.4	3.72 V	286	33.8	11.8

Remarks:

1. Emission Level(dBuV/m) = Raw Value(dBuV) + Correction Factor(dB/m)
2. Correction Factor(dB/m) = Antenna Factor(dB/m) + Cable Factor(dB) – Pre-Amplifier Factor(dB)
3. Margin value = Emission Level – Limit value
4. The other emission levels were very low against the limit.
5. " * ": Fundamental frequency.
6. " # ": The radiated frequency is out of the restricted band.

RF Mode	TX 802.11ax (HE20)	Channel	CH 52 : 5260 MHz
Frequency Range	1GHz ~ 40GHz	Detector Function	Peak (PK) Average (AV)

Antenna Polarity & Test Distance : Horizontal at 3 m								
No	Frequency (MHz)	Emission Level (dBuV/m)	Limit (dBuV/m)	Margin (dB)	Antenna Height (m)	Table Angle (Degree)	Raw Value (dBuV)	Correction Factor (dB/m)
1	5150.00	51.4 PK	74.0	-22.6	1.31 H	114	49.1	2.3
2	5150.00	38.1 AV	54.0	-15.9	1.31 H	114	35.8	2.3
3	*5260.00	107.8 PK			1.31 H	114	105.8	2.0
4	*5260.00	97.0 AV			1.31 H	114	95.0	2.0
5	#10520.00	51.6 PK	68.2	-16.6	2.72 H	162	39.6	12.0
6	15780.00	57.4 PK	74.0	-16.6	1.50 H	348	45.9	11.5
7	15780.00	44.2 AV	54.0	-9.8	1.50 H	348	32.7	11.5

Antenna Polarity & Test Distance : Vertical at 3 m								
No	Frequency (MHz)	Emission Level (dBuV/m)	Limit (dBuV/m)	Margin (dB)	Antenna Height (m)	Table Angle (Degree)	Raw Value (dBuV)	Correction Factor (dB/m)
1	5150.00	52.5 PK	74.0	-21.5	1.50 V	277	50.2	2.3
2	5150.00	39.6 AV	54.0	-14.4	1.50 V	277	37.3	2.3
3	*5260.00	120.3 PK			1.50 V	277	118.3	2.0
4	*5260.00	109.7 AV			1.50 V	277	107.7	2.0
5	#10520.00	53.2 PK	68.2	-15.0	3.63 V	198	41.2	12.0
6	15780.00	59.9 PK	74.0	-14.1	3.64 V	269	48.4	11.5
7	15780.00	45.4 AV	54.0	-8.6	3.64 V	269	33.9	11.5

Remarks:

1. Emission Level(dBuV/m) = Raw Value(dBuV) + Correction Factor(dB/m)
2. Correction Factor(dB/m) = Antenna Factor(dB/m) + Cable Factor(dB) – Pre-Amplifier Factor(dB)
3. Margin value = Emission Level – Limit value
4. The other emission levels were very low against the limit.
5. " * ": Fundamental frequency.
6. " # ": The radiated frequency is out of the restricted band.

RF Mode	TX 802.11ax (HE20)	Channel	CH 60 : 5300 MHz
Frequency Range	1GHz ~ 40GHz	Detector Function	Peak (PK) Average (AV)

Antenna Polarity & Test Distance : Horizontal at 3 m

No	Frequency (MHz)	Emission Level (dBuV/m)	Limit (dBuV/m)	Margin (dB)	Antenna Height (m)	Table Angle (Degree)	Raw Value (dBuV)	Correction Factor (dB/m)
1	*5300.00	108.4 PK			1.40 H	136	106.7	1.7
2	*5300.00	97.2 AV			1.40 H	136	95.5	1.7
3	5350.00	53.2 PK	74.0	-20.8	1.40 H	136	51.3	1.9
4	5350.00	42.8 AV	54.0	-11.2	1.40 H	136	40.9	1.9
5	10600.00	51.7 PK	74.0	-22.3	2.76 H	144	39.8	11.9
6	10600.00	40.7 AV	54.0	-13.3	2.76 H	144	28.8	11.9
7	15900.00	57.3 PK	74.0	-16.7	1.51 H	341	46.0	11.3
8	15900.00	44.1 AV	54.0	-9.9	1.51 H	341	32.8	11.3

Antenna Polarity & Test Distance : Vertical at 3 m

No	Frequency (MHz)	Emission Level (dBuV/m)	Limit (dBuV/m)	Margin (dB)	Antenna Height (m)	Table Angle (Degree)	Raw Value (dBuV)	Correction Factor (dB/m)
1	*5300.00	120.1 PK			1.52 V	273	118.4	1.7
2	*5300.00	109.6 AV			1.52 V	273	107.9	1.7
3	5350.00	61.3 PK	74.0	-12.7	1.52 V	273	59.4	1.9
4	5350.00	44.8 AV	54.0	-9.2	1.52 V	273	42.9	1.9
5	10600.00	53.2 PK	74.0	-20.8	3.55 V	192	41.3	11.9
6	10600.00	40.5 AV	54.0	-13.5	3.55 V	192	28.6	11.9
7	15900.00	59.8 PK	74.0	-14.2	3.61 V	271	48.5	11.3
8	15900.00	45.4 AV	54.0	-8.6	3.61 V	271	34.1	11.3

Remarks:

1. Emission Level(dBuV/m) = Raw Value(dBuV) + Correction Factor(dB/m)
2. Correction Factor(dB/m) = Antenna Factor(dB/m) + Cable Factor(dB) – Pre-Amplifier Factor(dB)
3. Margin value = Emission Level – Limit value
4. The other emission levels were very low against the limit.
5. " * ": Fundamental frequency.

RF Mode	TX 802.11ax (HE20)	Channel	CH 64 : 5320 MHz
Frequency Range	1GHz ~ 40GHz	Detector Function	Peak (PK) Average (AV)

Antenna Polarity & Test Distance : Horizontal at 3 m								
No	Frequency (MHz)	Emission Level (dBuV/m)	Limit (dBuV/m)	Margin (dB)	Antenna Height (m)	Table Angle (Degree)	Raw Value (dBuV)	Correction Factor (dB/m)
1	*5320.00	106.1 PK			1.52 H	138	104.3	1.8
2	*5320.00	95.4 AV			1.52 H	138	93.6	1.8
3	5350.00	54.3 PK	74.0	-19.7	1.52 H	138	52.4	1.9
4	5350.00	43.8 AV	54.0	-10.2	1.52 H	138	41.9	1.9
5	10640.00	51.7 PK	74.0	-22.3	2.80 H	167	39.9	11.8
6	10640.00	40.8 AV	54.0	-13.2	2.80 H	167	29.0	11.8
7	15960.00	57.9 PK	74.0	-16.1	1.54 H	349	46.3	11.6
8	15960.00	44.5 AV	54.0	-9.5	1.54 H	349	32.9	11.6

Antenna Polarity & Test Distance : Vertical at 3 m								
No	Frequency (MHz)	Emission Level (dBuV/m)	Limit (dBuV/m)	Margin (dB)	Antenna Height (m)	Table Angle (Degree)	Raw Value (dBuV)	Correction Factor (dB/m)
1	*5320.00	118.9 PK			1.43 V	288	117.1	1.8
2	*5320.00	107.8 AV			1.43 V	288	106.0	1.8
3	5350.00	67.3 PK	74.0	-6.7	1.43 V	288	65.4	1.9
4	5350.00	52.5 AV	54.0	-1.5	1.43 V	288	50.6	1.9
5	10640.00	53.0 PK	74.0	-21.0	3.52 V	202	41.2	11.8
6	10640.00	40.7 AV	54.0	-13.3	3.52 V	202	28.9	11.8
7	15960.00	59.9 PK	74.0	-14.1	3.65 V	289	48.3	11.6
8	15960.00	45.2 AV	54.0	-8.8	3.65 V	289	33.6	11.6

Remarks:

1. Emission Level(dBuV/m) = Raw Value(dBuV) + Correction Factor(dB/m)
2. Correction Factor(dB/m) = Antenna Factor(dB/m) + Cable Factor(dB) – Pre-Amplifier Factor(dB)
3. Margin value = Emission Level – Limit value
4. The other emission levels were very low against the limit.
5. " * ": Fundamental frequency.

RF Mode	TX 802.11ax (HE20)	Channel	CH 100 : 5500 MHz
Frequency Range	1GHz ~ 40GHz	Detector Function	Peak (PK) Average (AV)

Antenna Polarity & Test Distance : Horizontal at 3 m

No	Frequency (MHz)	Emission Level (dBuV/m)	Limit (dBuV/m)	Margin (dB)	Antenna Height (m)	Table Angle (Degree)	Raw Value (dBuV)	Correction Factor (dB/m)
1	5448.60	50.2 PK	74.0	-23.8	1.40 H	140	48.1	2.1
2	5448.60	39.2 AV	54.0	-14.8	1.40 H	140	37.1	2.1
3	#5468.55	52.7 PK	68.2	-15.5	1.40 H	140	50.5	2.2
4	*5500.00	103.5 PK			1.40 H	140	101.4	2.1
5	*5500.00	93.4 AV			1.40 H	140	91.3	2.1
6	11000.00	50.9 PK	74.0	-23.1	2.78 H	143	38.5	12.4
7	11000.00	40.7 AV	54.0	-13.3	2.78 H	143	28.3	12.4
8	#16500.00	57.9 PK	68.2	-10.3	1.55 H	333	44.2	13.7

Antenna Polarity & Test Distance : Vertical at 3 m

No	Frequency (MHz)	Emission Level (dBuV/m)	Limit (dBuV/m)	Margin (dB)	Antenna Height (m)	Table Angle (Degree)	Raw Value (dBuV)	Correction Factor (dB/m)
1	5458.40	60.7 PK	74.0	-13.3	1.39 V	272	58.6	2.1
2	5458.40	43.9 AV	54.0	-10.1	1.39 V	272	41.8	2.1
3	5460.00	58.2 PK	74.0	-15.8	1.39 V	272	56.1	2.1
4	5460.00	44.2 AV	54.0	-9.8	1.39 V	272	42.1	2.1
5	#5468.10	66.6 PK	68.2	-1.6	1.39 V	272	64.4	2.2
6	*5500.00	117.2 PK			1.39 V	272	115.1	2.1
7	*5500.00	105.5 AV			1.39 V	272	103.4	2.1
8	11000.00	55.8 PK	74.0	-18.2	3.93 V	181	43.4	12.4
9	11000.00	43.2 AV	54.0	-10.8	3.93 V	181	30.8	12.4
10	#16500.00	62.9 PK	68.2	-5.3	2.00 V	296	49.2	13.7

Remarks:

1. Emission Level(dBuV/m) = Raw Value(dBuV) + Correction Factor(dB/m)
2. Correction Factor(dB/m) = Antenna Factor(dB/m) + Cable Factor(dB) – Pre-Amplifier Factor(dB)
3. Margin value = Emission Level – Limit value
4. The other emission levels were very low against the limit.
5. " * ": Fundamental frequency.
6. " # ": The radiated frequency is out of the restricted band.

RF Mode	TX 802.11ax (HE20)	Channel	CH 116 : 5580 MHz
Frequency Range	1GHz ~ 40GHz	Detector Function	Peak (PK) Average (AV)

Antenna Polarity & Test Distance : Horizontal at 3 m								
No	Frequency (MHz)	Emission Level (dBuV/m)	Limit (dBuV/m)	Margin (dB)	Antenna Height (m)	Table Angle (Degree)	Raw Value (dBuV)	Correction Factor (dB/m)
1	5460.00	52.1 PK	74.0	-21.9	1.41 H	132	50.0	2.1
2	5460.00	41.8 AV	54.0	-12.2	1.41 H	132	39.7	2.1
3	#5470.00	54.5 PK	68.2	-13.7	1.41 H	132	52.3	2.2
4	*5580.00	108.1 PK			1.41 H	132	106.0	2.1
5	*5580.00	96.9 AV			1.41 H	132	94.8	2.1
6	11160.00	50.3 PK	74.0	-23.7	2.82 H	161	38.3	12.0
7	11160.00	40.1 AV	54.0	-13.9	2.82 H	161	28.1	12.0
8	#16740.00	56.7 PK	68.2	-11.5	1.47 H	355	41.4	15.3

Antenna Polarity & Test Distance : Vertical at 3 m								
No	Frequency (MHz)	Emission Level (dBuV/m)	Limit (dBuV/m)	Margin (dB)	Antenna Height (m)	Table Angle (Degree)	Raw Value (dBuV)	Correction Factor (dB/m)
1	5460.00	53.7 PK	74.0	-20.3	1.43 V	284	51.6	2.1
2	5460.00	42.4 AV	54.0	-11.6	1.43 V	284	40.3	2.1
3	#5470.00	55.5 PK	68.2	-12.7	1.43 V	284	53.3	2.2
4	*5580.00	120.3 PK			1.43 V	284	118.2	2.1
5	*5580.00	109.8 AV			1.43 V	284	107.7	2.1
6	11160.00	54.9 PK	74.0	-19.1	3.93 V	178	42.9	12.0
7	11160.00	42.4 AV	54.0	-11.6	3.93 V	178	30.4	12.0
8	#16740.00	62.7 PK	68.2	-5.5	2.06 V	284	47.4	15.3

Remarks:

1. Emission Level(dBuV/m) = Raw Value(dBuV) + Correction Factor(dB/m)
2. Correction Factor(dB/m) = Antenna Factor(dB/m) + Cable Factor(dB) – Pre-Amplifier Factor(dB)
3. Margin value = Emission Level – Limit value
4. The other emission levels were very low against the limit.
5. " * ": Fundamental frequency.
6. " # ": The radiated frequency is out of the restricted band.

RF Mode	TX 802.11ax (HE20)	Channel	CH 140 : 5700 MHz
Frequency Range	1GHz ~ 40GHz	Detector Function	Peak (PK) Average (AV)

Antenna Polarity & Test Distance : Horizontal at 3 m

No	Frequency (MHz)	Emission Level (dBuV/m)	Limit (dBuV/m)	Margin (dB)	Antenna Height (m)	Table Angle (Degree)	Raw Value (dBuV)	Correction Factor (dB/m)
1	*5700.00	104.3 PK			1.39 H	127	102.0	2.3
2	*5700.00	92.8 AV			1.39 H	127	90.5	2.3
3	#5727.81	54.9 PK	68.2	-13.3	1.39 H	127	52.4	2.5
4	11400.00	50.2 PK	74.0	-23.8	2.85 H	154	37.7	12.5
5	11400.00	39.9 AV	54.0	-14.1	2.85 H	154	27.4	12.5
6	#17100.00	57.6 PK	68.2	-10.6	1.56 H	348	40.8	16.8

Antenna Polarity & Test Distance : Vertical at 3 m

No	Frequency (MHz)	Emission Level (dBuV/m)	Limit (dBuV/m)	Margin (dB)	Antenna Height (m)	Table Angle (Degree)	Raw Value (dBuV)	Correction Factor (dB/m)
1	*5700.00	116.7 PK			1.50 V	264	114.4	2.3
2	*5700.00	105.6 AV			1.50 V	264	103.3	2.3
3	#5727.81	66.7 PK	68.2	-1.5	1.50 V	264	64.2	2.5
4	11400.00	55.3 PK	74.0	-18.7	3.93 V	168	42.8	12.5
5	11400.00	42.6 AV	54.0	-11.4	3.93 V	168	30.1	12.5
6	#17100.00	62.3 PK	68.2	-5.9	1.99 V	291	45.5	16.8

Remarks:

1. Emission Level(dBuV/m) = Raw Value(dBuV) + Correction Factor(dB/m)
2. Correction Factor(dB/m) = Antenna Factor(dB/m) + Cable Factor(dB) – Pre-Amplifier Factor(dB)
3. Margin value = Emission Level – Limit value
4. The other emission levels were very low against the limit.
5. " * " : Fundamental frequency.
6. " # " : The radiated frequency is out of the restricted band.

RF Mode	TX 802.11ax (HE20)	Channel	CH 144 : 5720 MHz
Frequency Range	1GHz ~ 40GHz	Detector Function	Peak (PK) Average (AV)

Antenna Polarity & Test Distance : Horizontal at 3 m								
No	Frequency (MHz)	Emission Level (dBuV/m)	Limit (dBuV/m)	Margin (dB)	Antenna Height (m)	Table Angle (Degree)	Raw Value (dBuV)	Correction Factor (dB/m)
1	5460.00	52.8 PK	74.0	-21.2	1.37 H	128	50.7	2.1
2	5460.00	38.4 AV	54.0	-15.6	1.37 H	128	36.3	2.1
3	#5470.00	53.5 PK	68.2	-14.7	1.37 H	128	51.3	2.2
4	*5720.00	108.6 PK			1.37 H	128	106.2	2.4
5	*5720.00	97.3 AV			1.37 H	128	94.9	2.4
6	#5850.00	53.0 PK	68.2	-15.2	1.37 H	128	50.3	2.7
7	11440.00	50.6 PK	74.0	-23.4	2.79 H	151	38.2	12.4
8	11440.00	40.2 AV	54.0	-13.8	2.79 H	151	27.8	12.4
9	#17160.00	57.0 PK	68.2	-11.2	1.56 H	329	40.4	16.6

Antenna Polarity & Test Distance : Vertical at 3 m								
No	Frequency (MHz)	Emission Level (dBuV/m)	Limit (dBuV/m)	Margin (dB)	Antenna Height (m)	Table Angle (Degree)	Raw Value (dBuV)	Correction Factor (dB/m)
1	5460.00	53.2 PK	74.0	-20.8	1.42 V	286	51.1	2.1
2	5460.00	39.9 AV	54.0	-14.1	1.42 V	286	37.8	2.1
3	#5470.00	53.8 PK	68.2	-14.4	1.42 V	286	51.6	2.2
4	*5720.00	120.1 PK			1.42 V	286	117.7	2.4
5	*5720.00	109.6 AV			1.42 V	286	107.2	2.4
6	#5850.00	53.2 PK	68.2	-15.0	1.42 V	286	50.5	2.7
7	11440.00	54.8 PK	74.0	-19.2	3.94 V	161	42.4	12.4
8	11440.00	42.5 AV	54.0	-11.5	3.94 V	161	30.1	12.4
9	#17160.00	62.9 PK	68.2	-5.3	2.08 V	288	46.3	16.6

Remarks:

1. Emission Level(dBuV/m) = Raw Value(dBuV) + Correction Factor(dB/m)
2. Correction Factor(dB/m) = Antenna Factor(dB/m) + Cable Factor(dB) – Pre-Amplifier Factor(dB)
3. Margin value = Emission Level – Limit value
4. The other emission levels were very low against the limit.
5. " * ": Fundamental frequency.
6. " # ": The radiated frequency is out of the restricted band.

RF Mode	TX 802.11ax (HE20)	Channel	CH 149 : 5745 MHz
Frequency Range	1GHz ~ 40GHz	Detector Function	Peak (PK) Average (AV)

Antenna Polarity & Test Distance : Horizontal at 3 m

No	Frequency (MHz)	Emission Level (dBuV/m)	Limit (dBuV/m)	Margin (dB)	Antenna Height (m)	Table Angle (Degree)	Raw Value (dBuV)	Correction Factor (dB/m)
1	#5551.71	50.8 PK	68.2	-17.4	1.48 H	145	48.7	2.1
2	*5745.00	108.3 PK			1.48 H	145	105.9	2.4
3	*5745.00	97.2 AV			1.48 H	145	94.8	2.4
4	#6020.62	50.1 PK	68.2	-18.1	1.48 H	145	47.1	3.0
5	11490.00	54.5 PK	74.0	-19.5	1.35 H	321	41.9	12.6
6	11490.00	42.9 AV	54.0	-11.1	1.35 H	321	30.3	12.6
7	#17235.00	57.6 PK	68.2	-10.6	3.55 H	323	40.8	16.8

Antenna Polarity & Test Distance : Vertical at 3 m

No	Frequency (MHz)	Emission Level (dBuV/m)	Limit (dBuV/m)	Margin (dB)	Antenna Height (m)	Table Angle (Degree)	Raw Value (dBuV)	Correction Factor (dB/m)
1	#5611.44	51.1 PK	68.2	-17.1	1.46 V	287	49.0	2.1
2	*5745.00	119.9 PK			1.46 V	287	117.5	2.4
3	*5745.00	108.5 AV			1.46 V	287	106.1	2.4
4	#5933.49	51.8 PK	68.2	-16.4	1.46 V	287	48.9	2.9
5	11490.00	55.0 PK	74.0	-19.0	1.23 V	289	42.4	12.6
6	11490.00	43.0 AV	54.0	-11.0	1.23 V	289	30.4	12.6
7	#17235.00	57.7 PK	68.2	-10.5	1.26 V	341	40.9	16.8

Remarks:

1. Emission Level(dBuV/m) = Raw Value(dBuV) + Correction Factor(dB/m)
2. Correction Factor(dB/m) = Antenna Factor(dB/m) + Cable Factor(dB) – Pre-Amplifier Factor(dB)
3. Margin value = Emission Level – Limit value
4. The other emission levels were very low against the limit.
5. " * ": Fundamental frequency.
6. " # ": The radiated frequency is out of the restricted band.

RF Mode	TX 802.11ax (HE20)	Channel	CH 157 : 5785 MHz
Frequency Range	1GHz ~ 40GHz	Detector Function	Peak (PK) Average (AV)

Antenna Polarity & Test Distance : Horizontal at 3 m

No	Frequency (MHz)	Emission Level (dBuV/m)	Limit (dBuV/m)	Margin (dB)	Antenna Height (m)	Table Angle (Degree)	Raw Value (dBuV)	Correction Factor (dB/m)
1	#5615.37	50.6 PK	68.2	-17.6	1.53 H	144	48.5	2.1
2	*5785.00	108.1 PK			1.53 H	144	105.5	2.6
3	*5785.00	96.8 AV			1.53 H	144	94.2	2.6
4	#5932.03	51.5 PK	68.2	-16.7	1.53 H	144	48.6	2.9
5	11570.00	54.0 PK	74.0	-20.0	1.37 H	320	41.4	12.6
6	11570.00	42.4 AV	54.0	-11.6	1.37 H	320	29.8	12.6
7	#17355.00	57.3 PK	68.2	-10.9	3.60 H	303	39.6	17.7

Antenna Polarity & Test Distance : Vertical at 3 m

No	Frequency (MHz)	Emission Level (dBuV/m)	Limit (dBuV/m)	Margin (dB)	Antenna Height (m)	Table Angle (Degree)	Raw Value (dBuV)	Correction Factor (dB/m)
1	#5633.10	51.1 PK	68.2	-17.1	1.50 V	274	48.8	2.3
2	*5785.00	120.2 PK			1.50 V	274	117.6	2.6
3	*5785.00	108.6 AV			1.50 V	274	106.0	2.6
4	#5974.18	52.4 PK	68.2	-15.8	1.50 V	274	49.5	2.9
5	11570.00	53.6 PK	74.0	-20.4	1.24 V	307	41.0	12.6
6	11570.00	42.0 AV	54.0	-12.0	1.24 V	307	29.4	12.6
7	#17355.00	58.5 PK	68.2	-9.7	1.29 V	357	40.8	17.7

Remarks:

1. Emission Level(dBuV/m) = Raw Value(dBuV) + Correction Factor(dB/m)
2. Correction Factor(dB/m) = Antenna Factor(dB/m) + Cable Factor(dB) – Pre-Amplifier Factor(dB)
3. Margin value = Emission Level – Limit value
4. The other emission levels were very low against the limit.
5. " * ": Fundamental frequency.
6. " # ": The radiated frequency is out of the restricted band.

RF Mode	TX 802.11ax (HE20)	Channel	CH 165 : 5825 MHz
Frequency Range	1GHz ~ 40GHz	Detector Function	Peak (PK) Average (AV)

Antenna Polarity & Test Distance : Horizontal at 3 m

No	Frequency (MHz)	Emission Level (dBuV/m)	Limit (dBuV/m)	Margin (dB)	Antenna Height (m)	Table Angle (Degree)	Raw Value (dBuV)	Correction Factor (dB/m)
1	#5599.66	50.5 PK	68.2	-17.7	1.47 H	141	48.4	2.1
2	*5825.00	107.9 PK			1.47 H	141	105.3	2.6
3	*5825.00	97.4 AV			1.47 H	141	94.8	2.6
4	#6001.24	50.5 PK	68.2	-17.7	1.47 H	141	47.6	2.9
5	11650.00	54.2 PK	74.0	-19.8	1.37 H	324	42.0	12.2
6	11650.00	42.3 AV	54.0	-11.7	1.37 H	324	30.1	12.2
7	#17475.00	56.9 PK	68.2	-11.3	3.57 H	301	38.2	18.7

Antenna Polarity & Test Distance : Vertical at 3 m

No	Frequency (MHz)	Emission Level (dBuV/m)	Limit (dBuV/m)	Margin (dB)	Antenna Height (m)	Table Angle (Degree)	Raw Value (dBuV)	Correction Factor (dB/m)
1	#5641.13	51.4 PK	68.2	-16.8	1.48 V	276	49.1	2.3
2	*5825.00	119.7 PK			1.48 V	276	117.1	2.6
3	*5825.00	109.2 AV			1.48 V	276	106.6	2.6
4	#5931.86	54.8 PK	68.2	-13.4	1.48 V	276	51.9	2.9
5	11650.00	54.9 PK	74.0	-19.1	1.20 V	295	42.7	12.2
6	11650.00	42.9 AV	54.0	-11.1	1.20 V	295	30.7	12.2
7	#17475.00	58.3 PK	68.2	-9.9	1.25 V	332	39.6	18.7

Remarks:

1. Emission Level(dBuV/m) = Raw Value(dBuV) + Correction Factor(dB/m)
2. Correction Factor(dB/m) = Antenna Factor(dB/m) + Cable Factor(dB) – Pre-Amplifier Factor(dB)
3. Margin value = Emission Level – Limit value
4. The other emission levels were very low against the limit.
5. " * ": Fundamental frequency.
6. " # ": The radiated frequency is out of the restricted band.

RF Mode	TX 802.11ax (HE40)	Channel	CH 38 : 5190 MHz
Frequency Range	1GHz ~ 40GHz	Detector Function	Peak (PK) Average (AV)

Antenna Polarity & Test Distance : Horizontal at 3 m								
No	Frequency (MHz)	Emission Level (dBuV/m)	Limit (dBuV/m)	Margin (dB)	Antenna Height (m)	Table Angle (Degree)	Raw Value (dBuV)	Correction Factor (dB/m)
1	5150.00	57.8 PK	74.0	-16.2	1.50 H	128	55.5	2.3
2	5150.00	44.3 AV	54.0	-9.7	1.50 H	128	42.0	2.3
3	*5190.00	101.1 PK			1.50 H	128	99.0	2.1
4	*5190.00	90.1 AV			1.50 H	128	88.0	2.1
5	#10380.00	51.2 PK	68.2	-17.0	2.80 H	140	39.2	12.0
6	15570.00	57.5 PK	74.0	-16.5	1.53 H	349	45.8	11.7
7	15570.00	44.1 AV	54.0	-9.9	1.53 H	349	32.4	11.7

Antenna Polarity & Test Distance : Vertical at 3 m								
No	Frequency (MHz)	Emission Level (dBuV/m)	Limit (dBuV/m)	Margin (dB)	Antenna Height (m)	Table Angle (Degree)	Raw Value (dBuV)	Correction Factor (dB/m)
1	5148.00	67.4 PK	74.0	-6.6	1.42 V	278	65.1	2.3
2	5148.00	52.5 AV	54.0	-1.5	1.42 V	278	50.2	2.3
3	*5190.00	111.3 PK			1.42 V	278	109.2	2.1
4	*5190.00	100.0 AV			1.42 V	278	97.9	2.1
5	#10380.00	52.0 PK	68.2	-16.2	3.01 V	157	40.0	12.0
6	15570.00	59.6 PK	74.0	-14.4	3.74 V	279	47.9	11.7
7	15570.00	45.1 AV	54.0	-8.9	3.74 V	279	33.4	11.7

Remarks:

1. Emission Level(dBuV/m) = Raw Value(dBuV) + Correction Factor(dB/m)
2. Correction Factor(dB/m) = Antenna Factor(dB/m) + Cable Factor(dB) – Pre-Amplifier Factor(dB)
3. Margin value = Emission Level – Limit value
4. The other emission levels were very low against the limit.
5. " * ": Fundamental frequency.
6. " # ": The radiated frequency is out of the restricted band.

RF Mode	TX 802.11ax (HE40)	Channel	CH 46 : 5230 MHz
Frequency Range	1GHz ~ 40GHz	Detector Function	Peak (PK) Average (AV)

Antenna Polarity & Test Distance : Horizontal at 3 m

No	Frequency (MHz)	Emission Level (dBuV/m)	Limit (dBuV/m)	Margin (dB)	Antenna Height (m)	Table Angle (Degree)	Raw Value (dBuV)	Correction Factor (dB/m)
1	5150.00	58.2 PK	74.0	-15.8	1.51 H	114	55.9	2.3
2	5150.00	41.8 AV	54.0	-12.2	1.51 H	114	39.5	2.3
3	*5230.00	105.3 PK			1.51 H	114	103.2	2.1
4	*5230.00	94.1 AV			1.51 H	114	92.0	2.1
5	5350.00	55.9 PK	74.0	-18.1	1.51 H	114	54.0	1.9
6	5350.00	38.2 AV	54.0	-15.8	1.51 H	114	36.3	1.9
7	#10460.00	51.1 PK	68.2	-17.1	2.81 H	161	39.1	12.0
8	15690.00	57.7 PK	74.0	-16.3	1.53 H	352	45.8	11.9
9	15690.00	44.5 AV	54.0	-9.5	1.53 H	352	32.6	11.9

Antenna Polarity & Test Distance : Vertical at 3 m

No	Frequency (MHz)	Emission Level (dBuV/m)	Limit (dBuV/m)	Margin (dB)	Antenna Height (m)	Table Angle (Degree)	Raw Value (dBuV)	Correction Factor (dB/m)
1	5150.00	62.5 PK	74.0	-11.5	1.48 V	275	60.2	2.3
2	5150.00	45.7 AV	54.0	-8.3	1.48 V	275	43.4	2.3
3	*5230.00	117.2 PK			1.48 V	275	115.1	2.1
4	*5230.00	104.3 AV			1.48 V	275	102.2	2.1
5	5350.00	57.9 PK	74.0	-16.1	1.48 V	275	56.0	1.9
6	5350.00	39.1 AV	54.0	-14.9	1.48 V	275	37.2	1.9
7	#10460.00	52.2 PK	68.2	-16.0	3.06 V	169	40.2	12.0
8	15690.00	59.4 PK	74.0	-14.6	3.79 V	300	47.5	11.9
9	15690.00	44.8 AV	54.0	-9.2	3.79 V	300	32.9	11.9

Remarks:

1. Emission Level(dBuV/m) = Raw Value(dBuV) + Correction Factor(dB/m)
2. Correction Factor(dB/m) = Antenna Factor(dB/m) + Cable Factor(dB) – Pre-Amplifier Factor(dB)
3. Margin value = Emission Level – Limit value
4. The other emission levels were very low against the limit.
5. " * ": Fundamental frequency.
6. " # ": The radiated frequency is out of the restricted band.

RF Mode	TX 802.11ax (HE40)	Channel	CH 54 : 5270 MHz
Frequency Range	1GHz ~ 40GHz	Detector Function	Peak (PK) Average (AV)

Antenna Polarity & Test Distance : Horizontal at 3 m

No	Frequency (MHz)	Emission Level (dBuV/m)	Limit (dBuV/m)	Margin (dB)	Antenna Height (m)	Table Angle (Degree)	Raw Value (dBuV)	Correction Factor (dB/m)
1	5150.00	56.1 PK	74.0	-17.9	1.55 H	127	53.8	2.3
2	5150.00	38.6 AV	54.0	-15.4	1.55 H	127	36.3	2.3
3	*5270.00	104.9 PK			1.55 H	127	103.0	1.9
4	*5270.00	93.9 AV			1.55 H	127	92.0	1.9
5	5350.00	59.2 PK	74.0	-14.8	1.55 H	127	57.3	1.9
6	5350.00	42.9 AV	54.0	-11.1	1.55 H	127	41.0	1.9
7	#10540.00	50.9 PK	68.2	-17.3	2.75 H	151	39.0	11.9
8	15810.00	57.8 PK	74.0	-16.2	1.49 H	337	46.4	11.4
9	15810.00	44.4 AV	54.0	-9.6	1.49 H	337	33.0	11.4

Antenna Polarity & Test Distance : Vertical at 3 m

No	Frequency (MHz)	Emission Level (dBuV/m)	Limit (dBuV/m)	Margin (dB)	Antenna Height (m)	Table Angle (Degree)	Raw Value (dBuV)	Correction Factor (dB/m)
1	5150.00	52.1 PK	74.0	-21.9	1.44 V	277	49.8	2.3
2	5150.00	39.0 AV	54.0	-15.0	1.44 V	277	36.7	2.3
3	*5270.00	117.2 PK			1.44 V	277	115.3	1.9
4	*5270.00	104.1 AV			1.44 V	277	102.2	1.9
5	5350.00	66.5 PK	74.0	-7.5	1.44 V	277	64.6	1.9
6	5350.00	46.3 AV	54.0	-7.7	1.44 V	277	44.4	1.9
7	#10540.00	53.4 PK	68.2	-14.8	3.56 V	197	41.5	11.9
8	15810.00	59.2 PK	74.0	-14.8	3.58 V	296	47.8	11.4
9	15810.00	44.8 AV	54.0	-9.2	3.58 V	296	33.4	11.4

Remarks:

1. Emission Level(dBuV/m) = Raw Value(dBuV) + Correction Factor(dB/m)
2. Correction Factor(dB/m) = Antenna Factor(dB/m) + Cable Factor(dB) – Pre-Amplifier Factor(dB)
3. Margin value = Emission Level – Limit value
4. The other emission levels were very low against the limit.
5. " * ": Fundamental frequency.
6. " # ": The radiated frequency is out of the restricted band.

RF Mode	TX 802.11ax (HE40)	Channel	CH 62 : 5310 MHz
Frequency Range	1GHz ~ 40GHz	Detector Function	Peak (PK) Average (AV)

Antenna Polarity & Test Distance : Horizontal at 3 m

No	Frequency (MHz)	Emission Level (dBuV/m)	Limit (dBuV/m)	Margin (dB)	Antenna Height (m)	Table Angle (Degree)	Raw Value (dBuV)	Correction Factor (dB/m)
1	*5310.00	99.5 PK			1.28 H	134	97.7	1.8
2	*5310.00	89.5 AV			1.28 H	134	87.7	1.8
3	5350.00	57.9 PK	74.0	-16.1	1.28 H	134	56.0	1.9
4	5350.00	42.9 AV	54.0	-11.1	1.28 H	134	41.0	1.9
5	10620.00	51.4 PK	74.0	-22.6	2.73 H	147	39.6	11.8
6	10620.00	40.7 AV	54.0	-13.3	2.73 H	147	28.9	11.8
7	15930.00	57.6 PK	74.0	-16.4	1.51 H	354	46.1	11.5
8	15930.00	44.2 AV	54.0	-9.8	1.51 H	354	32.7	11.5

Antenna Polarity & Test Distance : Vertical at 3 m

No	Frequency (MHz)	Emission Level (dBuV/m)	Limit (dBuV/m)	Margin (dB)	Antenna Height (m)	Table Angle (Degree)	Raw Value (dBuV)	Correction Factor (dB/m)
1	*5310.00	113.5 PK			1.30 V	287	111.7	1.8
2	*5310.00	101.2 AV			1.30 V	287	99.4	1.8
3	5350.00	68.1 PK	74.0	-5.9	1.30 V	287	66.2	1.9
4	5350.00	52.5 AV	54.0	-1.5	1.30 V	287	50.6	1.9
5	10620.00	53.8 PK	74.0	-20.2	3.58 V	197	42.0	11.8
6	10620.00	41.2 AV	54.0	-12.8	3.58 V	197	29.4	11.8
7	15930.00	59.9 PK	74.0	-14.1	3.63 V	295	48.4	11.5
8	15930.00	45.6 AV	54.0	-8.4	3.63 V	295	34.1	11.5

Remarks:

1. Emission Level(dBuV/m) = Raw Value(dBuV) + Correction Factor(dB/m)
2. Correction Factor(dB/m) = Antenna Factor(dB/m) + Cable Factor(dB) – Pre-Amplifier Factor(dB)
3. Margin value = Emission Level – Limit value
4. The other emission levels were very low against the limit.
5. " * ": Fundamental frequency.

RF Mode	TX 802.11ax (HE40)	Channel	CH 102 : 5510 MHz
Frequency Range	1GHz ~ 40GHz	Detector Function	Peak (PK) Average (AV)

Antenna Polarity & Test Distance : Horizontal at 3 m

No	Frequency (MHz)	Emission Level (dBuV/m)	Limit (dBuV/m)	Margin (dB)	Antenna Height (m)	Table Angle (Degree)	Raw Value (dBuV)	Correction Factor (dB/m)
1	5459.20	51.3 PK	74.0	-22.7	1.40 H	141	49.2	2.1
2	5459.20	39.6 AV	54.0	-14.4	1.40 H	141	37.5	2.1
3	5460.00	50.5 PK	74.0	-23.5	1.40 H	141	48.4	2.1
4	5460.00	39.8 AV	54.0	-14.2	1.40 H	141	37.7	2.1
5	#5464.50	54.5 PK	68.2	-13.7	1.40 H	141	52.4	2.1
6	*5510.00	99.1 PK			1.40 H	141	97.0	2.1
7	*5510.00	88.3 AV			1.40 H	141	86.2	2.1
8	11020.00	50.7 PK	74.0	-23.3	2.83 H	157	38.4	12.3
9	11020.00	40.3 AV	54.0	-13.7	2.83 H	157	28.0	12.3
10	#16530.00	57.3 PK	68.2	-10.9	1.51 H	342	43.4	13.9

Antenna Polarity & Test Distance : Vertical at 3 m

No	Frequency (MHz)	Emission Level (dBuV/m)	Limit (dBuV/m)	Margin (dB)	Antenna Height (m)	Table Angle (Degree)	Raw Value (dBuV)	Correction Factor (dB/m)
1	5457.31	62.1 PK	74.0	-11.9	1.10 V	280	60.0	2.1
2	5457.31	46.5 AV	54.0	-7.5	1.10 V	280	44.4	2.1
3	5460.00	59.6 PK	74.0	-14.4	1.10 V	280	57.5	2.1
4	5460.00	48.2 AV	54.0	-5.8	1.10 V	280	46.1	2.1
5	#5468.35	66.4 PK	68.2	-1.8	1.10 V	280	64.2	2.2
6	*5510.00	111.6 PK			1.10 V	280	109.5	2.1
7	*5510.00	100.2 AV			1.10 V	280	98.1	2.1
8	11020.00	55.4 PK	74.0	-18.6	3.99 V	182	43.1	12.3
9	11020.00	43.0 AV	54.0	-11.0	3.99 V	182	30.7	12.3
10	#16530.00	62.3 PK	68.2	-5.9	2.05 V	291	48.4	13.9

Remarks:

1. Emission Level(dBuV/m) = Raw Value(dBuV) + Correction Factor(dB/m)
2. Correction Factor(dB/m) = Antenna Factor(dB/m) + Cable Factor(dB) – Pre-Amplifier Factor(dB)
3. Margin value = Emission Level – Limit value
4. The other emission levels were very low against the limit.
5. " * ": Fundamental frequency.
6. " # ": The radiated frequency is out of the restricted band.

RF Mode	TX 802.11ax (HE40)	Channel	CH 110 : 5550 MHz
Frequency Range	1GHz ~ 40GHz	Detector Function	Peak (PK) Average (AV)

Antenna Polarity & Test Distance : Horizontal at 3 m								
No	Frequency (MHz)	Emission Level (dBuV/m)	Limit (dBuV/m)	Margin (dB)	Antenna Height (m)	Table Angle (Degree)	Raw Value (dBuV)	Correction Factor (dB/m)
1	5460.00	54.3 PK	74.0	-19.7	1.37 H	153	52.2	2.1
2	5460.00	40.4 AV	54.0	-13.6	1.37 H	153	38.3	2.1
3	#5470.00	56.1 PK	68.2	-12.1	1.37 H	153	53.9	2.2
4	*5550.00	104.7 PK			1.37 H	153	102.6	2.1
5	*5550.00	93.6 AV			1.37 H	153	91.5	2.1
6	11100.00	50.7 PK	74.0	-23.3	2.82 H	156	38.8	11.9
7	11100.00	40.5 AV	54.0	-13.5	2.82 H	156	28.6	11.9
8	#16650.00	57.7 PK	68.2	-10.5	1.52 H	339	42.9	14.8
Antenna Polarity & Test Distance : Vertical at 3 m								
No	Frequency (MHz)	Emission Level (dBuV/m)	Limit (dBuV/m)	Margin (dB)	Antenna Height (m)	Table Angle (Degree)	Raw Value (dBuV)	Correction Factor (dB/m)
1	5460.00	58.3 PK	74.0	-15.7	1.15 V	292	56.2	2.1
2	5460.00	44.0 AV	54.0	-10.0	1.15 V	292	41.9	2.1
3	#5470.00	63.9 PK	68.2	-4.3	1.15 V	292	61.7	2.2
4	*5550.00	116.5 PK			1.15 V	292	114.4	2.1
5	*5550.00	104.1 AV			1.15 V	292	102.0	2.1
6	11100.00	55.6 PK	74.0	-18.4	3.90 V	158	43.7	11.9
7	11100.00	42.8 AV	54.0	-11.2	3.90 V	158	30.9	11.9
8	#16650.00	63.0 PK	68.2	-5.2	2.05 V	304	48.2	14.8

Remarks:

1. Emission Level(dBuV/m) = Raw Value(dBuV) + Correction Factor(dB/m)
2. Correction Factor(dB/m) = Antenna Factor(dB/m) + Cable Factor(dB) – Pre-Amplifier Factor(dB)
3. Margin value = Emission Level – Limit value
4. The other emission levels were very low against the limit.
5. " * ": Fundamental frequency.
6. " # ": The radiated frequency is out of the restricted band.

RF Mode	TX 802.11ax (HE40)	Channel	CH 134 : 5670 MHz
Frequency Range	1GHz ~ 40GHz	Detector Function	Peak (PK) Average (AV)

Antenna Polarity & Test Distance : Horizontal at 3 m

No	Frequency (MHz)	Emission Level (dBuV/m)	Limit (dBuV/m)	Margin (dB)	Antenna Height (m)	Table Angle (Degree)	Raw Value (dBuV)	Correction Factor (dB/m)
1	*5670.00	100.0 PK			1.46 H	139	97.7	2.3
2	*5670.00	90.1 AV			1.46 H	139	87.8	2.3
3	#5727.93	58.6 PK	68.2	-9.6	1.46 H	139	56.1	2.5
4	11340.00	50.8 PK	74.0	-23.2	2.82 H	138	38.6	12.2
5	11340.00	40.6 AV	54.0	-13.4	2.82 H	138	28.4	12.2
6	#17010.00	57.6 PK	68.2	-10.6	1.48 H	332	41.0	16.6

Antenna Polarity & Test Distance : Vertical at 3 m

No	Frequency (MHz)	Emission Level (dBuV/m)	Limit (dBuV/m)	Margin (dB)	Antenna Height (m)	Table Angle (Degree)	Raw Value (dBuV)	Correction Factor (dB/m)
1	*5670.00	114.7 PK			1.51 V	265	112.4	2.3
2	*5670.00	102.4 AV			1.51 V	265	100.1	2.3
3	#5727.93	66.6 PK	68.2	-1.6	1.51 V	265	64.1	2.5
4	11340.00	55.0 PK	74.0	-19.0	3.84 V	185	42.8	12.2
5	11340.00	42.3 AV	54.0	-11.7	3.84 V	185	30.1	12.2
6	#17010.00	62.6 PK	68.2	-5.6	2.02 V	279	46.0	16.6

Remarks:

1. Emission Level(dBuV/m) = Raw Value(dBuV) + Correction Factor(dB/m)
2. Correction Factor(dB/m) = Antenna Factor(dB/m) + Cable Factor(dB) – Pre-Amplifier Factor(dB)
3. Margin value = Emission Level – Limit value
4. The other emission levels were very low against the limit.
5. " * " : Fundamental frequency.
6. " # " : The radiated frequency is out of the restricted band.

RF Mode	TX 802.11ax (HE40)	Channel	CH 142 : 5710 MHz
Frequency Range	1GHz ~ 40GHz	Detector Function	Peak (PK) Average (AV)

Antenna Polarity & Test Distance : Horizontal at 3 m

No	Frequency (MHz)	Emission Level (dBuV/m)	Limit (dBuV/m)	Margin (dB)	Antenna Height (m)	Table Angle (Degree)	Raw Value (dBuV)	Correction Factor (dB/m)
1	5460.00	50.7 PK	74.0	-23.3	1.41 H	140	48.6	2.1
2	5460.00	38.6 AV	54.0	-15.4	1.41 H	140	36.5	2.1
3	#5470.00	50.8 PK	68.2	-17.4	1.41 H	140	48.6	2.2
4	*5710.00	102.2 PK			1.41 H	140	99.8	2.4
5	*5710.00	92.3 AV			1.41 H	140	89.9	2.4
6	#5850.00	53.4 PK	68.2	-14.8	1.41 H	140	50.7	2.7
7	11420.00	50.7 PK	74.0	-23.3	2.76 H	148	38.2	12.5
8	11420.00	40.6 AV	54.0	-13.4	2.76 H	148	28.1	12.5
9	#17130.00	57.1 PK	68.2	-11.1	1.56 H	340	40.3	16.8

Antenna Polarity & Test Distance : Vertical at 3 m

No	Frequency (MHz)	Emission Level (dBuV/m)	Limit (dBuV/m)	Margin (dB)	Antenna Height (m)	Table Angle (Degree)	Raw Value (dBuV)	Correction Factor (dB/m)
1	5460.00	51.1 PK	74.0	-22.9	1.05 V	290	49.0	2.1
2	5460.00	39.4 AV	54.0	-14.6	1.05 V	290	37.3	2.1
3	#5470.00	51.4 PK	68.2	-16.8	1.05 V	290	49.2	2.2
4	*5710.00	116.9 PK			1.05 V	290	114.5	2.4
5	*5710.00	104.6 AV			1.05 V	290	102.2	2.4
6	#5850.00	56.6 PK	68.2	-11.6	1.05 V	290	53.9	2.7
7	11420.00	55.2 PK	74.0	-18.8	4.00 V	180	42.7	12.5
8	11420.00	42.5 AV	54.0	-11.5	4.00 V	180	30.0	12.5
9	#17130.00	63.1 PK	68.2	-5.1	2.08 V	281	46.3	16.8

Remarks:

1. Emission Level(dBuV/m) = Raw Value(dBuV) + Correction Factor(dB/m)
2. Correction Factor(dB/m) = Antenna Factor(dB/m) + Cable Factor(dB) – Pre-Amplifier Factor(dB)
3. Margin value = Emission Level – Limit value
4. The other emission levels were very low against the limit.
5. " * ": Fundamental frequency.
6. " # ": The radiated frequency is out of the restricted band.

RF Mode	TX 802.11ax (HE40)	Channel	CH 151 : 5755 MHz
Frequency Range	1GHz ~ 40GHz	Detector Function	Peak (PK) Average (AV)

Antenna Polarity & Test Distance : Horizontal at 3 m

No	Frequency (MHz)	Emission Level (dBuV/m)	Limit (dBuV/m)	Margin (dB)	Antenna Height (m)	Table Angle (Degree)	Raw Value (dBuV)	Correction Factor (dB/m)
1	#5561.15	49.2 PK	68.2	-19.0	1.42 H	144	47.1	2.1
2	*5755.00	104.8 PK			1.42 H	144	102.3	2.5
3	*5755.00	92.1 AV			1.42 H	144	89.6	2.5
4	#5943.36	50.5 PK	68.2	-17.7	1.42 H	144	47.6	2.9
5	11510.00	53.9 PK	74.0	-20.1	1.32 H	312	41.3	12.6
6	11510.00	42.0 AV	54.0	-12.0	1.32 H	312	29.4	12.6
7	#17265.00	57.3 PK	68.2	-10.9	3.55 H	325	40.4	16.9

Antenna Polarity & Test Distance : Vertical at 3 m

No	Frequency (MHz)	Emission Level (dBuV/m)	Limit (dBuV/m)	Margin (dB)	Antenna Height (m)	Table Angle (Degree)	Raw Value (dBuV)	Correction Factor (dB/m)
1	#5643.73	55.5 PK	68.2	-12.7	1.50 V	287	53.2	2.3
2	*5755.00	117.3 PK			1.50 V	287	114.8	2.5
3	*5755.00	104.1 AV			1.50 V	287	101.6	2.5
4	#5938.30	52.5 PK	68.2	-15.7	1.50 V	287	49.6	2.9
5	11510.00	55.5 PK	74.0	-18.5	1.24 V	311	42.9	12.6
6	11510.00	43.2 AV	54.0	-10.8	1.24 V	311	30.6	12.6
7	#17265.00	57.6 PK	68.2	-10.6	1.22 V	326	40.7	16.9

Remarks:

1. Emission Level(dBuV/m) = Raw Value(dBuV) + Correction Factor(dB/m)
2. Correction Factor(dB/m) = Antenna Factor(dB/m) + Cable Factor(dB) – Pre-Amplifier Factor(dB)
3. Margin value = Emission Level – Limit value
4. The other emission levels were very low against the limit.
5. " * ": Fundamental frequency.
6. " # ": The radiated frequency is out of the restricted band.

RF Mode	TX 802.11ax (HE40)	Channel	CH 159 : 5795 MHz
Frequency Range	1GHz ~ 40GHz	Detector Function	Peak (PK) Average (AV)

Antenna Polarity & Test Distance : Horizontal at 3 m								
No	Frequency (MHz)	Emission Level (dBuV/m)	Limit (dBuV/m)	Margin (dB)	Antenna Height (m)	Table Angle (Degree)	Raw Value (dBuV)	Correction Factor (dB/m)
1	#5554.88	50.0 PK	68.2	-18.2	1.46 H	147	47.9	2.1
2	*5795.00	103.7 PK			1.46 H	147	101.1	2.6
3	*5795.00	92.2 AV			1.46 H	147	89.6	2.6
4	#6002.18	50.5 PK	68.2	-17.7	1.46 H	147	47.6	2.9
5	11590.00	54.2 PK	74.0	-19.8	1.31 H	326	41.6	12.6
6	11590.00	42.2 AV	54.0	-11.8	1.31 H	326	29.6	12.6
7	#17385.00	57.0 PK	68.2	-11.2	3.56 H	321	39.1	17.9

Antenna Polarity & Test Distance : Vertical at 3 m								
No	Frequency (MHz)	Emission Level (dBuV/m)	Limit (dBuV/m)	Margin (dB)	Antenna Height (m)	Table Angle (Degree)	Raw Value (dBuV)	Correction Factor (dB/m)
1	#5559.42	51.2 PK	68.2	-17.0	1.59 V	267	49.1	2.1
2	*5795.00	116.8 PK			1.59 V	267	114.2	2.6
3	*5795.00	103.8 AV			1.59 V	267	101.2	2.6
4	#5925.20	55.7 PK	68.2	-12.5	1.59 V	267	52.8	2.9
5	11590.00	55.4 PK	74.0	-18.6	1.18 V	309	42.8	12.6
6	11590.00	43.2 AV	54.0	-10.8	1.18 V	309	30.6	12.6
7	#17385.00	58.1 PK	68.2	-10.1	1.22 V	339	40.2	17.9

Remarks:

1. Emission Level(dBuV/m) = Raw Value(dBuV) + Correction Factor(dB/m)
2. Correction Factor(dB/m) = Antenna Factor(dB/m) + Cable Factor(dB) – Pre-Amplifier Factor(dB)
3. Margin value = Emission Level – Limit value
4. The other emission levels were very low against the limit.
5. " * ": Fundamental frequency.
6. " # ": The radiated frequency is out of the restricted band.

RF Mode	TX 802.11ax (HE80)	Channel	CH 42 : 5210 MHz
Frequency Range	1GHz ~ 40GHz	Detector Function	Peak (PK) Average (AV)

Antenna Polarity & Test Distance : Horizontal at 3 m

No	Frequency (MHz)	Emission Level (dBuV/m)	Limit (dBuV/m)	Margin (dB)	Antenna Height (m)	Table Angle (Degree)	Raw Value (dBuV)	Correction Factor (dB/m)
1	5147.35	55.0 PK	74.0	-19.0	1.64 H	135	52.7	2.3
2	5147.35	42.3 AV	54.0	-11.7	1.64 H	135	40.0	2.3
3	*5210.00	95.5 PK			1.64 H	135	93.4	2.1
4	*5210.00	83.2 AV			1.64 H	135	81.1	2.1
5	5361.50	49.1 PK	74.0	-24.9	1.64 H	135	47.1	2.0
6	5361.50	38.4 AV	54.0	-15.6	1.64 H	135	36.4	2.0
7	#10420.00	51.2 PK	68.2	-17.0	2.80 H	157	39.1	12.1
8	15630.00	57.7 PK	74.0	-16.3	1.54 H	349	46.0	11.7
9	15630.00	44.4 AV	54.0	-9.6	1.54 H	349	32.7	11.7

Antenna Polarity & Test Distance : Vertical at 3 m

No	Frequency (MHz)	Emission Level (dBuV/m)	Limit (dBuV/m)	Margin (dB)	Antenna Height (m)	Table Angle (Degree)	Raw Value (dBuV)	Correction Factor (dB/m)
1	5147.76	67.1 PK	74.0	-6.9	1.56 V	264	64.8	2.3
2	5147.76	52.3 AV	54.0	-1.7	1.56 V	264	50.0	2.3
3	*5210.00	107.5 PK			1.56 V	264	105.4	2.1
4	*5210.00	94.5 AV			1.56 V	264	92.4	2.1
5	5350.00	50.7 PK	74.0	-23.3	1.56 V	264	48.8	1.9
6	5350.00	39.7 AV	54.0	-14.3	1.56 V	264	37.8	1.9
7	#10420.00	52.7 PK	68.2	-15.5	3.03 V	174	40.6	12.1
8	15630.00	58.7 PK	74.0	-15.3	3.72 V	288	47.0	11.7
9	15630.00	44.6 AV	54.0	-9.4	3.72 V	288	32.9	11.7

Remarks:

1. Emission Level(dBuV/m) = Raw Value(dBuV) + Correction Factor(dB/m)
2. Correction Factor(dB/m) = Antenna Factor(dB/m) + Cable Factor(dB) – Pre-Amplifier Factor(dB)
3. Margin value = Emission Level – Limit value
4. The other emission levels were very low against the limit.
5. " * ": Fundamental frequency.
6. " # ": The radiated frequency is out of the restricted band.

RF Mode	TX 802.11ax (HE80)	Channel	CH 58 : 5290 MHz
Frequency Range	1GHz ~ 40GHz	Detector Function	Peak (PK) Average (AV)

Antenna Polarity & Test Distance : Horizontal at 3 m

No	Frequency (MHz)	Emission Level (dBuV/m)	Limit (dBuV/m)	Margin (dB)	Antenna Height (m)	Table Angle (Degree)	Raw Value (dBuV)	Correction Factor (dB/m)
1	4822.63	50.8 PK	74.0	-23.2	1.48 H	134	49.0	1.8
2	4822.63	37.6 AV	54.0	-16.4	1.48 H	134	35.8	1.8
3	5097.80	47.3 PK	74.0	-26.7	1.48 H	134	45.0	2.3
4	5097.80	39.0 AV	54.0	-15.0	1.48 H	134	36.7	2.3
5	*5290.00	95.1 PK			1.48 H	134	93.3	1.8
6	*5290.00	84.1 AV			1.48 H	134	82.3	1.8
7	5375.90	58.3 PK	74.0	-15.7	1.48 H	134	56.3	2.0
8	5375.90	42.5 AV	54.0	-11.5	1.48 H	134	40.5	2.0
9	#10580.00	51.7 PK	68.2	-16.5	2.79 H	159	39.9	11.8
10	15870.00	58.1 PK	74.0	-15.9	1.46 H	339	46.8	11.3
11	15870.00	44.6 AV	54.0	-9.4	1.46 H	339	33.3	11.3

Antenna Polarity & Test Distance : Vertical at 3 m

No	Frequency (MHz)	Emission Level (dBuV/m)	Limit (dBuV/m)	Margin (dB)	Antenna Height (m)	Table Angle (Degree)	Raw Value (dBuV)	Correction Factor (dB/m)
1	5145.00	55.2 PK	74.0	-18.8	1.23 V	287	52.9	2.3
2	5145.00	40.3 AV	54.0	-13.7	1.23 V	287	38.0	2.3
3	*5290.00	108.3 PK			1.23 V	287	106.5	1.8
4	*5290.00	95.4 AV			1.23 V	287	93.6	1.8
5	5353.63	70.2 PK	74.0	-3.8	1.23 V	287	68.2	2.0
6	5353.63	52.5 AV	54.0	-1.5	1.23 V	287	50.5	2.0
7	#10580.00	53.8 PK	68.2	-14.4	3.59 V	183	42.0	11.8
8	15870.00	58.8 PK	74.0	-15.2	3.58 V	293	47.5	11.3
9	15870.00	44.5 AV	54.0	-9.5	3.58 V	293	33.2	11.3

Remarks:

1. Emission Level(dBuV/m) = Raw Value(dBuV) + Correction Factor(dB/m)
2. Correction Factor(dB/m) = Antenna Factor(dB/m) + Cable Factor(dB) – Pre-Amplifier Factor(dB)
3. Margin value = Emission Level – Limit value
4. The other emission levels were very low against the limit.
5. " * ": Fundamental frequency.
6. " # ": The radiated frequency is out of the restricted band.

RF Mode	TX 802.11ax (HE80)	Channel	CH 106 : 5530 MHz
Frequency Range	1GHz ~ 40GHz	Detector Function	Peak (PK) Average (AV)

Antenna Polarity & Test Distance : Horizontal at 3 m								
No	Frequency (MHz)	Emission Level (dBuV/m)	Limit (dBuV/m)	Margin (dB)	Antenna Height (m)	Table Angle (Degree)	Raw Value (dBuV)	Correction Factor (dB/m)
1	5450.50	51.9 PK	74.0	-22.1	1.64 H	146	49.8	2.1
2	5450.50	40.1 AV	54.0	-13.9	1.64 H	146	38.0	2.1
3	#5467.20	55.1 PK	68.2	-13.1	1.64 H	146	52.9	2.2
4	#5496.91	48.6 PK	68.2	-19.6	1.64 H	146	46.5	2.1
5	*5530.00	94.7 PK			1.64 H	146	92.7	2.0
6	*5530.00	82.1 AV			1.64 H	146	80.1	2.0
7	#5770.00	51.4 PK	68.2	-16.8	1.64 H	146	48.9	2.5
8	11060.00	51.3 PK	74.0	-22.7	2.83 H	155	39.2	12.1
9	11060.00	40.6 AV	54.0	-13.4	2.83 H	155	28.5	12.1
10	#16590.00	57.1 PK	68.2	-11.1	1.56 H	337	42.8	14.3

Antenna Polarity & Test Distance : Vertical at 3 m								
No	Frequency (MHz)	Emission Level (dBuV/m)	Limit (dBuV/m)	Margin (dB)	Antenna Height (m)	Table Angle (Degree)	Raw Value (dBuV)	Correction Factor (dB/m)
1	5458.64	66.0 PK	74.0	-8.0	1.47 V	271	63.9	2.1
2	5458.64	49.0 AV	54.0	-5.0	1.47 V	271	46.9	2.1
3	#5496.91	66.7 PK	68.2	-1.5	1.47 V	271	64.6	2.1
4	*5530.00	106.8 PK			1.47 V	271	104.8	2.0
5	*5530.00	94.1 AV			1.47 V	271	92.1	2.0
6	#5818.59	52.1 PK	68.2	-16.1	1.47 V	271	49.5	2.6
7	11060.00	55.6 PK	74.0	-18.4	3.89 V	169	43.5	12.1
8	11060.00	42.5 AV	54.0	-11.5	3.89 V	169	30.4	12.1
9	#16590.00	63.0 PK	68.2	-5.2	2.10 V	312	48.7	14.3

Remarks:

1. Emission Level(dBuV/m) = Raw Value(dBuV) + Correction Factor(dB/m)
2. Correction Factor(dB/m) = Antenna Factor(dB/m) + Cable Factor(dB) – Pre-Amplifier Factor(dB)
3. Margin value = Emission Level – Limit value
4. The other emission levels were very low against the limit.
5. " * ": Fundamental frequency.
6. " # ": The radiated frequency is out of the restricted band.

RF Mode	TX 802.11ax (HE80)	Channel	CH 122 : 5610 MHz
Frequency Range	1GHz ~ 40GHz	Detector Function	Peak (PK) Average (AV)

Antenna Polarity & Test Distance : Horizontal at 3 m

No	Frequency (MHz)	Emission Level (dBuV/m)	Limit (dBuV/m)	Margin (dB)	Antenna Height (m)	Table Angle (Degree)	Raw Value (dBuV)	Correction Factor (dB/m)
1	*5610.00	97.3 PK			1.40 H	133	95.2	2.1
2	*5610.00	86.2 AV			1.40 H	133	84.1	2.1
3	#5725.00	56.3 PK	68.2	-11.9	1.40 H	133	53.9	2.4
4	11220.00	51.3 PK	74.0	-22.7	2.76 H	140	39.2	12.1
5	11220.00	40.6 AV	54.0	-13.4	2.76 H	140	28.5	12.1
6	#16830.00	57.7 PK	68.2	-10.5	1.44 H	350	41.9	15.8

Antenna Polarity & Test Distance : Vertical at 3 m

No	Frequency (MHz)	Emission Level (dBuV/m)	Limit (dBuV/m)	Margin (dB)	Antenna Height (m)	Table Angle (Degree)	Raw Value (dBuV)	Correction Factor (dB/m)
1	*5610.00	110.8 PK			1.29 V	289	108.7	2.1
2	*5610.00	97.8 AV			1.29 V	289	95.7	2.1
3	#5725.00	66.6 PK	68.2	-1.6	1.29 V	289	64.2	2.4
4	11220.00	55.3 PK	74.0	-18.7	3.95 V	173	43.2	12.1
5	11220.00	42.7 AV	54.0	-11.3	3.95 V	173	30.6	12.1
6	#16830.00	62.9 PK	68.2	-5.3	2.06 V	300	47.1	15.8

Remarks:

1. Emission Level(dBuV/m) = Raw Value(dBuV) + Correction Factor(dB/m)
2. Correction Factor(dB/m) = Antenna Factor(dB/m) + Cable Factor(dB) – Pre-Amplifier Factor(dB)
3. Margin value = Emission Level – Limit value
4. The other emission levels were very low against the limit.
5. " * " : Fundamental frequency.
6. " # " : The radiated frequency is out of the restricted band.

RF Mode	TX 802.11ax (HE80)	Channel	CH 138 : 5690 MHz
Frequency Range	1GHz ~ 40GHz	Detector Function	Peak (PK) Average (AV)

Antenna Polarity & Test Distance : Horizontal at 3 m								
No	Frequency (MHz)	Emission Level (dBuV/m)	Limit (dBuV/m)	Margin (dB)	Antenna Height (m)	Table Angle (Degree)	Raw Value (dBuV)	Correction Factor (dB/m)
1	5460.00	54.9 PK	74.0	-19.1	1.38 H	141	52.8	2.1
2	5460.00	38.9 AV	54.0	-15.1	1.38 H	141	36.8	2.1
3	#5470.00	55.1 PK	68.2	-13.1	1.38 H	141	52.9	2.2
4	*5690.00	98.6 PK			1.38 H	141	96.3	2.3
5	*5690.00	87.3 AV			1.38 H	141	85.0	2.3
6	#5850.00	56.8 PK	68.2	-11.4	1.38 H	141	54.1	2.7
7	11380.00	50.9 PK	74.0	-23.1	2.74 H	131	38.5	12.4
8	11380.00	40.7 AV	54.0	-13.3	2.74 H	131	28.3	12.4
9	#17070.00	57.4 PK	68.2	-10.8	1.47 H	333	40.6	16.8

Antenna Polarity & Test Distance : Vertical at 3 m								
No	Frequency (MHz)	Emission Level (dBuV/m)	Limit (dBuV/m)	Margin (dB)	Antenna Height (m)	Table Angle (Degree)	Raw Value (dBuV)	Correction Factor (dB/m)
1	5460.00	55.2 PK	74.0	-18.8	1.24 V	299	53.1	2.1
2	5460.00	40.2 AV	54.0	-13.8	1.24 V	299	38.1	2.1
3	#5470.00	56.9 PK	68.2	-11.3	1.24 V	299	54.7	2.2
4	*5690.00	111.1 PK			1.24 V	299	108.8	2.3
5	*5690.00	98.6 AV			1.24 V	299	96.3	2.3
6	#5850.00	66.5 PK	68.2	-1.7	1.24 V	299	63.8	2.7
7	11380.00	55.5 PK	74.0	-18.5	3.91 V	145	43.1	12.4
8	11380.00	42.9 AV	54.0	-11.1	3.91 V	145	30.5	12.4
9	#17070.00	62.5 PK	68.2	-5.7	2.06 V	294	45.7	16.8

Remarks:

1. Emission Level(dBuV/m) = Raw Value(dBuV) + Correction Factor(dB/m)
2. Correction Factor(dB/m) = Antenna Factor(dB/m) + Cable Factor(dB) – Pre-Amplifier Factor(dB)
3. Margin value = Emission Level – Limit value
4. The other emission levels were very low against the limit.
5. " * ": Fundamental frequency.
6. " # ": The radiated frequency is out of the restricted band.

RF Mode	TX 802.11ax (HE80)	Channel	CH 155 : 5775 MHz
Frequency Range	1GHz ~ 40GHz	Detector Function	Peak (PK) Average (AV)

Antenna Polarity & Test Distance : Horizontal at 3 m

No	Frequency (MHz)	Emission Level (dBuV/m)	Limit (dBuV/m)	Margin (dB)	Antenna Height (m)	Table Angle (Degree)	Raw Value (dBuV)	Correction Factor (dB/m)
1	#5645.58	52.2 PK	68.2	-16.0	1.41 H	144	49.9	2.3
2	*5775.00	98.6 PK			1.41 H	144	96.1	2.5
3	*5775.00	87.2 AV			1.41 H	144	84.7	2.5
4	#5924.91	52.9 PK	68.3	-15.4	1.41 H	144	50.0	2.9
5	11550.00	53.7 PK	74.0	-20.3	1.35 H	317	41.2	12.5
6	11550.00	42.1 AV	54.0	-11.9	1.35 H	317	29.6	12.5
7	#17325.00	57.9 PK	68.2	-10.3	3.52 H	318	40.6	17.3

Antenna Polarity & Test Distance : Vertical at 3 m

No	Frequency (MHz)	Emission Level (dBuV/m)	Limit (dBuV/m)	Margin (dB)	Antenna Height (m)	Table Angle (Degree)	Raw Value (dBuV)	Correction Factor (dB/m)
1	#5640.86	63.6 PK	68.2	-4.6	1.25 V	277	61.3	2.3
2	*5775.00	111.7 PK			1.25 V	277	109.2	2.5
3	*5775.00	99.4 AV			1.25 V	277	96.9	2.5
4	#5930.23	63.8 PK	68.2	-4.4	1.25 V	277	60.9	2.9
5	11550.00	55.3 PK	74.0	-18.7	1.19 V	303	42.8	12.5
6	11550.00	43.2 AV	54.0	-10.8	1.19 V	303	30.7	12.5
7	#17325.00	58.1 PK	68.2	-10.1	1.26 V	353	40.8	17.3

Remarks:

1. Emission Level(dBuV/m) = Raw Value(dBuV) + Correction Factor(dB/m)
2. Correction Factor(dB/m) = Antenna Factor(dB/m) + Cable Factor(dB) – Pre-Amplifier Factor(dB)
3. Margin value = Emission Level – Limit value
4. The other emission levels were very low against the limit.
5. " * ": Fundamental frequency.
6. " # ": The radiated frequency is out of the restricted band.

RF Mode	TX 20MHz Preamble 802.11ax (RU26)	Channel	CH 36 : 5180 MHz
Frequency Range	1GHz ~ 40GHz	Detector Function	Peak (PK) Average (AV)

Antenna Polarity & Test Distance : Horizontal at 3 m

No	Frequency (MHz)	Emission Level (dBuV/m)	Limit (dBuV/m)	Margin (dB)	Antenna Height (m)	Table Angle (Degree)	Raw Value (dBuV)	Correction Factor (dB/m)
1	5144.57	53.9 PK	74.0	-20.1	1.44 H	137	51.6	2.3
2	5144.57	39.3 AV	54.0	-14.7	1.44 H	137	37.0	2.3
3	*5180.00	114.1 PK			1.44 H	137	111.9	2.2
4	*5180.00	100.4 AV			1.44 H	137	98.2	2.2
5	#10360.00	58.3 PK	68.2	-9.9	1.22 H	280	46.5	11.8
6	15540.00	62.7 PK	74.0	-11.3	1.30 H	327	50.9	11.8
7	15540.00	50.2 AV	54.0	-3.8	1.30 H	327	38.4	11.8

Antenna Polarity & Test Distance : Vertical at 3 m

No	Frequency (MHz)	Emission Level (dBuV/m)	Limit (dBuV/m)	Margin (dB)	Antenna Height (m)	Table Angle (Degree)	Raw Value (dBuV)	Correction Factor (dB/m)
1	5139.50	60.6 PK	74.0	-13.4	1.24 V	288	58.3	2.3
2	5139.50	42.5 AV	54.0	-11.5	1.24 V	288	40.2	2.3
3	5146.80	56.7 PK	74.0	-17.3	1.24 V	288	54.4	2.3
4	5146.80	43.7 AV	54.0	-10.3	1.24 V	288	41.4	2.3
5	*5180.00	125.1 PK			1.24 V	288	122.9	2.2
6	*5180.00	113.9 AV			1.24 V	288	111.7	2.2
7	#10360.00	59.1 PK	68.2	-9.1	2.21 V	277	47.3	11.8
8	15540.00	61.2 PK	74.0	-12.8	1.96 V	323	49.4	11.8
9	15540.00	49.5 AV	54.0	-4.5	1.96 V	323	37.7	11.8

Remarks:

1. Emission Level(dBuV/m) = Raw Value(dBuV) + Correction Factor(dB/m)
2. Correction Factor(dB/m) = Antenna Factor(dB/m) + Cable Factor(dB) – Pre-Amplifier Factor(dB)
3. Margin value = Emission Level – Limit value
4. The other emission levels were very low against the limit.
5. " * ": Fundamental frequency.
6. " # ": The radiated frequency is out of the restricted band.

RF Mode	TX 20MHz Preamble 802.11ax (RU26)	Channel	CH 40 : 5200 MHz
Frequency Range	1GHz ~ 40GHz	Detector Function	Peak (PK) Average (AV)

Antenna Polarity & Test Distance : Horizontal at 3 m

No	Frequency (MHz)	Emission Level (dBuV/m)	Limit (dBuV/m)	Margin (dB)	Antenna Height (m)	Table Angle (Degree)	Raw Value (dBuV)	Correction Factor (dB/m)
1	5150.00	51.7 PK	74.0	-22.3	1.49 H	141	49.4	2.3
2	5150.00	41.2 AV	54.0	-12.8	1.49 H	141	38.9	2.3
3	*5200.00	114.5 PK			1.49 H	141	112.4	2.1
4	*5200.00	100.8 AV			1.49 H	141	98.7	2.1
5	#10400.00	58.2 PK	68.2	-10.0	1.25 H	294	46.2	12.0
6	15600.00	62.4 PK	74.0	-11.6	1.29 H	338	50.9	11.5
7	15600.00	49.8 AV	54.0	-4.2	1.29 H	338	38.3	11.5

Antenna Polarity & Test Distance : Vertical at 3 m

No	Frequency (MHz)	Emission Level (dBuV/m)	Limit (dBuV/m)	Margin (dB)	Antenna Height (m)	Table Angle (Degree)	Raw Value (dBuV)	Correction Factor (dB/m)
1	5150.00	52.7 PK	74.0	-21.3	1.36 V	281	50.4	2.3
2	5150.00	42.4 AV	54.0	-11.6	1.36 V	281	40.1	2.3
3	*5200.00	125.7 PK			1.36 V	281	123.6	2.1
4	*5200.00	114.7 AV			1.36 V	281	112.6	2.1
5	#10400.00	59.4 PK	68.2	-8.8	2.17 V	282	47.4	12.0
6	15600.00	61.5 PK	74.0	-12.5	1.95 V	317	50.0	11.5
7	15600.00	49.6 AV	54.0	-4.4	1.95 V	317	38.1	11.5

Remarks:

1. Emission Level(dBuV/m) = Raw Value(dBuV) + Correction Factor(dB/m)
2. Correction Factor(dB/m) = Antenna Factor(dB/m) + Cable Factor(dB) – Pre-Amplifier Factor(dB)
3. Margin value = Emission Level – Limit value
4. The other emission levels were very low against the limit.
5. " * ": Fundamental frequency.
6. " # ": The radiated frequency is out of the restricted band.

RF Mode	TX 20MHz Preamble 802.11ax (RU26)	Channel	CH 48 : 5240 MHz
Frequency Range	1GHz ~ 40GHz	Detector Function	Peak (PK) Average (AV)

Antenna Polarity & Test Distance : Horizontal at 3 m

No	Frequency (MHz)	Emission Level (dBuV/m)	Limit (dBuV/m)	Margin (dB)	Antenna Height (m)	Table Angle (Degree)	Raw Value (dBuV)	Correction Factor (dB/m)
1	5150.00	52.7 PK	74.0	-21.3	1.49 H	131	50.4	2.3
2	5150.00	38.1 AV	54.0	-15.9	1.49 H	131	35.8	2.3
3	*5240.00	114.1 PK			1.49 H	131	112.1	2.0
4	*5240.00	100.2 AV			1.49 H	131	98.2	2.0
5	5350.00	50.7 PK	74.0	-23.3	1.49 H	131	48.8	1.9
6	5350.00	37.7 AV	54.0	-16.3	1.49 H	131	35.8	1.9
7	#10480.00	57.9 PK	68.2	-10.3	1.27 H	265	46.0	11.9
8	15720.00	62.7 PK	74.0	-11.3	1.26 H	328	50.9	11.8
9	15720.00	50.3 AV	54.0	-3.7	1.26 H	328	38.5	11.8

Antenna Polarity & Test Distance : Vertical at 3 m

No	Frequency (MHz)	Emission Level (dBuV/m)	Limit (dBuV/m)	Margin (dB)	Antenna Height (m)	Table Angle (Degree)	Raw Value (dBuV)	Correction Factor (dB/m)
1	5150.00	52.6 PK	74.0	-21.4	1.37 V	273	50.3	2.3
2	5150.00	39.3 AV	54.0	-14.7	1.37 V	273	37.0	2.3
3	*5240.00	124.4 PK			1.37 V	273	122.4	2.0
4	*5240.00	113.5 AV			1.37 V	273	111.5	2.0
5	5350.00	50.9 PK	74.0	-23.1	1.37 V	273	49.0	1.9
6	5350.00	38.1 AV	54.0	-15.9	1.37 V	273	36.2	1.9
7	#10480.00	59.0 PK	68.2	-9.2	2.22 V	289	47.1	11.9
8	15720.00	61.7 PK	74.0	-12.3	1.91 V	336	49.9	11.8
9	15720.00	49.8 AV	54.0	-4.2	1.91 V	336	38.0	11.8

Remarks:

1. Emission Level(dBuV/m) = Raw Value(dBuV) + Correction Factor(dB/m)
2. Correction Factor(dB/m) = Antenna Factor(dB/m) + Cable Factor(dB) – Pre-Amplifier Factor(dB)
3. Margin value = Emission Level – Limit value
4. The other emission levels were very low against the limit.
5. " * ": Fundamental frequency.
6. " # ": The radiated frequency is out of the restricted band.

RF Mode	TX 20MHz Preamble 802.11ax (RU26)	Channel	CH 52 : 5260 MHz
Frequency Range	1GHz ~ 40GHz	Detector Function	Peak (PK) Average (AV)

Antenna Polarity & Test Distance : Horizontal at 3 m

No	Frequency (MHz)	Emission Level (dBuV/m)	Limit (dBuV/m)	Margin (dB)	Antenna Height (m)	Table Angle (Degree)	Raw Value (dBuV)	Correction Factor (dB/m)
1	5150.00	53.1 PK	74.0	-20.9	1.49 H	125	50.8	2.3
2	5150.00	38.6 AV	54.0	-15.4	1.49 H	125	36.3	2.3
3	*5260.00	114.3 PK			1.49 H	125	112.3	2.0
4	*5260.00	100.4 AV			1.49 H	125	98.4	2.0
5	5350.00	51.0 PK	74.0	-23.0	1.49 H	125	49.1	1.9
6	5350.00	38.0 AV	54.0	-16.0	1.49 H	125	36.1	1.9
7	#10520.00	58.1 PK	68.2	-10.1	1.21 H	280	46.1	12.0
8	15780.00	62.7 PK	74.0	-11.3	1.35 H	339	51.2	11.5
9	15780.00	50.3 AV	54.0	-3.7	1.35 H	339	38.8	11.5

Antenna Polarity & Test Distance : Vertical at 3 m

No	Frequency (MHz)	Emission Level (dBuV/m)	Limit (dBuV/m)	Margin (dB)	Antenna Height (m)	Table Angle (Degree)	Raw Value (dBuV)	Correction Factor (dB/m)
1	5150.00	52.6 PK	74.0	-21.4	1.51 V	278	50.3	2.3
2	5150.00	39.5 AV	54.0	-14.5	1.51 V	278	37.2	2.3
3	*5260.00	124.9 PK			1.51 V	278	122.9	2.0
4	*5260.00	113.8 AV			1.51 V	278	111.8	2.0
5	5350.00	50.5 PK	74.0	-23.5	1.51 V	278	48.6	1.9
6	5350.00	38.4 AV	54.0	-15.6	1.51 V	278	36.5	1.9
7	#10520.00	59.1 PK	68.2	-9.1	2.27 V	278	47.1	12.0
8	15780.00	61.5 PK	74.0	-12.5	2.00 V	309	50.0	11.5
9	15780.00	49.8 AV	54.0	-4.2	2.00 V	309	38.3	11.5

Remarks:

1. Emission Level(dBuV/m) = Raw Value(dBuV) + Correction Factor(dB/m)
2. Correction Factor(dB/m) = Antenna Factor(dB/m) + Cable Factor(dB) – Pre-Amplifier Factor(dB)
3. Margin value = Emission Level – Limit value
4. The other emission levels were very low against the limit.
5. " * ": Fundamental frequency.
6. " # ": The radiated frequency is out of the restricted band.

RF Mode	TX 20MHz Preamble 802.11ax (RU26)	Channel	CH 60 : 5300 MHz
Frequency Range	1GHz ~ 40GHz	Detector Function	Peak (PK) Average (AV)

Antenna Polarity & Test Distance : Horizontal at 3 m

No	Frequency (MHz)	Emission Level (dBuV/m)	Limit (dBuV/m)	Margin (dB)	Antenna Height (m)	Table Angle (Degree)	Raw Value (dBuV)	Correction Factor (dB/m)
1	*5300.00	113.9 PK			1.44 H	142	112.2	1.7
2	*5300.00	100.1 AV			1.44 H	142	98.4	1.7
3	5350.00	51.1 PK	74.0	-22.9	1.44 H	142	49.2	1.9
4	5350.00	40.7 AV	54.0	-13.3	1.44 H	142	38.8	1.9
5	10600.00	58.8 PK	74.0	-15.2	1.19 H	293	46.9	11.9
6	10600.00	49.2 AV	54.0	-4.8	1.19 H	293	37.3	11.9
7	15900.00	62.9 PK	74.0	-11.1	1.28 H	328	51.6	11.3
8	15900.00	50.4 AV	54.0	-3.6	1.28 H	328	39.1	11.3

Antenna Polarity & Test Distance : Vertical at 3 m

No	Frequency (MHz)	Emission Level (dBuV/m)	Limit (dBuV/m)	Margin (dB)	Antenna Height (m)	Table Angle (Degree)	Raw Value (dBuV)	Correction Factor (dB/m)
1	*5300.00	125.3 PK			1.57 V	273	123.6	1.7
2	*5300.00	114.3 AV			1.57 V	273	112.6	1.7
3	5350.00	51.7 PK	74.0	-22.3	1.57 V	273	49.8	1.9
4	5350.00	41.3 AV	54.0	-12.7	1.57 V	273	39.4	1.9
5	10600.00	58.6 PK	74.0	-15.4	2.20 V	261	46.7	11.9
6	10600.00	49.2 AV	54.0	-4.8	2.20 V	261	37.3	11.9
7	15900.00	61.3 PK	74.0	-12.7	2.02 V	332	50.0	11.3
8	15900.00	49.7 AV	54.0	-4.3	2.02 V	332	38.4	11.3

Remarks:

1. Emission Level(dBuV/m) = Raw Value(dBuV) + Correction Factor(dB/m)
2. Correction Factor(dB/m) = Antenna Factor(dB/m) + Cable Factor(dB) – Pre-Amplifier Factor(dB)
3. Margin value = Emission Level – Limit value
4. The other emission levels were very low against the limit.
5. " * ": Fundamental frequency.

RF Mode	TX 20MHz Preamble 802.11ax (RU26)	Channel	CH 64 : 5320 MHz
Frequency Range	1GHz ~ 40GHz	Detector Function	Peak (PK) Average (AV)

Antenna Polarity & Test Distance : Horizontal at 3 m

No	Frequency (MHz)	Emission Level (dBuV/m)	Limit (dBuV/m)	Margin (dB)	Antenna Height (m)	Table Angle (Degree)	Raw Value (dBuV)	Correction Factor (dB/m)
1	*5320.00	112.6 PK			1.55 H	143	110.8	1.8
2	*5320.00	100.6 AV			1.55 H	143	98.8	1.8
3	5350.00	51.0 PK	74.0	-23.0	1.55 H	143	49.1	1.9
4	5350.00	38.0 AV	54.0	-16.0	1.55 H	143	36.1	1.9
5	5367.82	48.1 PK	74.0	-25.9	1.55 H	143	46.1	2.0
6	5367.82	38.6 AV	54.0	-15.4	1.55 H	143	36.6	2.0
7	10640.00	58.9 PK	74.0	-15.1	1.18 H	285	47.1	11.8
8	10640.00	49.1 AV	54.0	-4.9	1.18 H	285	37.3	11.8
9	15960.00	62.8 PK	74.0	-11.2	1.33 H	319	51.2	11.6
10	15960.00	50.1 AV	54.0	-3.9	1.33 H	319	38.5	11.6

Antenna Polarity & Test Distance : Vertical at 3 m

No	Frequency (MHz)	Emission Level (dBuV/m)	Limit (dBuV/m)	Margin (dB)	Antenna Height (m)	Table Angle (Degree)	Raw Value (dBuV)	Correction Factor (dB/m)
1	*5320.00	125.1 PK			1.50 V	294	123.3	1.8
2	*5320.00	113.9 AV			1.50 V	294	112.1	1.8
3	5354.80	61.0 PK	74.0	-13.0	1.50 V	294	59.0	2.0
4	5354.80	43.4 AV	54.0	-10.6	1.50 V	294	41.4	2.0
5	5368.90	54.6 PK	74.0	-19.4	1.50 V	294	52.6	2.0
6	5368.90	46.5 AV	54.0	-7.5	1.50 V	294	44.5	2.0
7	10640.00	59.0 PK	74.0	-15.0	2.19 V	287	47.2	11.8
8	10640.00	49.5 AV	54.0	-4.5	2.19 V	287	37.7	11.8
9	15960.00	61.4 PK	74.0	-12.6	1.94 V	308	49.8	11.6
10	15960.00	49.5 AV	54.0	-4.5	1.94 V	308	37.9	11.6

Remarks:

1. Emission Level(dBuV/m) = Raw Value(dBuV) + Correction Factor(dB/m)
2. Correction Factor(dB/m) = Antenna Factor(dB/m) + Cable Factor(dB) – Pre-Amplifier Factor(dB)
3. Margin value = Emission Level – Limit value
4. The other emission levels were very low against the limit.
5. " * ": Fundamental frequency.

RF Mode	TX 20MHz Preamble 802.11ax (RU26)	Channel	CH 100 : 5500 MHz
Frequency Range	1GHz ~ 40GHz	Detector Function	Peak (PK) Average (AV)

Antenna Polarity & Test Distance : Horizontal at 3 m

No	Frequency (MHz)	Emission Level (dBuV/m)	Limit (dBuV/m)	Margin (dB)	Antenna Height (m)	Table Angle (Degree)	Raw Value (dBuV)	Correction Factor (dB/m)
1	5454.00	49.4 PK	74.0	-24.6	1.53 H	140	47.3	2.1
2	5454.00	37.9 AV	54.0	-16.1	1.53 H	140	35.8	2.1
3	#5468.70	53.5 PK	68.2	-14.7	1.53 H	140	51.3	2.2
4	*5500.00	111.2 PK			1.53 H	140	109.1	2.1
5	*5500.00	100.3 AV			1.53 H	140	98.2	2.1
6	11000.00	57.7 PK	74.0	-16.3	1.19 H	279	45.3	12.4
7	11000.00	48.3 AV	54.0	-5.7	1.19 H	279	35.9	12.4
8	#16500.00	62.2 PK	68.2	-6.0	1.26 H	343	48.5	13.7

Antenna Polarity & Test Distance : Vertical at 3 m

No	Frequency (MHz)	Emission Level (dBuV/m)	Limit (dBuV/m)	Margin (dB)	Antenna Height (m)	Table Angle (Degree)	Raw Value (dBuV)	Correction Factor (dB/m)
1	5457.76	59.3 PK	74.0	-14.7	1.46 V	283	57.2	2.1
2	5457.76	43.3 AV	54.0	-10.7	1.46 V	283	41.2	2.1
3	#5460.82	66.0 PK	68.2	-2.2	1.00 V	0	63.9	2.1
4	*5500.00	124.3 PK			1.46 V	283	122.2	2.1
5	*5500.00	114.2 AV			1.46 V	283	112.1	2.1
6	11000.00	59.1 PK	74.0	-14.9	2.23 V	293	46.7	12.4
7	11000.00	49.4 AV	54.0	-4.6	2.23 V	293	37.0	12.4
8	#16500.00	60.8 PK	68.2	-7.4	1.98 V	313	47.1	13.7

Remarks:

1. Emission Level(dBuV/m) = Raw Value(dBuV) + Correction Factor(dB/m)
2. Correction Factor(dB/m) = Antenna Factor(dB/m) + Cable Factor(dB) – Pre-Amplifier Factor(dB)
3. Margin value = Emission Level – Limit value
4. The other emission levels were very low against the limit.
5. " * ": Fundamental frequency.
6. " # ": The radiated frequency is out of the restricted band.

RF Mode	TX 20MHz Preamble 802.11ax (RU26)	Channel	CH 116 : 5580 MHz
Frequency Range	1GHz ~ 40GHz	Detector Function	Peak (PK) Average (AV)

Antenna Polarity & Test Distance : Horizontal at 3 m

No	Frequency (MHz)	Emission Level (dBuV/m)	Limit (dBuV/m)	Margin (dB)	Antenna Height (m)	Table Angle (Degree)	Raw Value (dBuV)	Correction Factor (dB/m)
1	*5580.00	114.9 PK			1.47 H	143	112.8	2.1
2	*5580.00	100.9 AV			1.47 H	143	98.8	2.1
3	11160.00	58.9 PK	74.0	-15.1	1.24 H	280	46.9	12.0
4	11160.00	49.2 AV	54.0	-4.8	1.24 H	280	37.2	12.0
5	#16740.00	62.1 PK	68.2	-6.1	1.31 H	339	46.8	15.3

Antenna Polarity & Test Distance : Vertical at 3 m

No	Frequency (MHz)	Emission Level (dBuV/m)	Limit (dBuV/m)	Margin (dB)	Antenna Height (m)	Table Angle (Degree)	Raw Value (dBuV)	Correction Factor (dB/m)
1	*5580.00	125.2 PK			1.51 V	295	123.1	2.1
2	*5580.00	113.7 AV			1.51 V	295	111.6	2.1
3	11160.00	58.8 PK	74.0	-15.2	2.18 V	280	46.8	12.0
4	11160.00	49.3 AV	54.0	-4.7	2.18 V	280	37.3	12.0
5	#16740.00	61.5 PK	68.2	-6.7	1.93 V	334	46.2	15.3

Remarks:

1. Emission Level(dBuV/m) = Raw Value(dBuV) + Correction Factor(dB/m)
2. Correction Factor(dB/m) = Antenna Factor(dB/m) + Cable Factor(dB) – Pre-Amplifier Factor(dB)
3. Margin value = Emission Level – Limit value
4. The other emission levels were very low against the limit.
5. " * " : Fundamental frequency.
6. " # " : The radiated frequency is out of the restricted band.

RF Mode	TX 20MHz Preamble 802.11ax (RU26)	Channel	CH 140 : 5700 MHz
Frequency Range	1GHz ~ 40GHz	Detector Function	Peak (PK) Average (AV)

Antenna Polarity & Test Distance : Horizontal at 3 m

No	Frequency (MHz)	Emission Level (dBuV/m)	Limit (dBuV/m)	Margin (dB)	Antenna Height (m)	Table Angle (Degree)	Raw Value (dBuV)	Correction Factor (dB/m)
1	*5700.00	113.7 PK			1.49 H	133	111.4	2.3
2	*5700.00	99.7 AV			1.49 H	133	97.4	2.3
3	#5725.00	60.2 PK	68.2	-8.0	1.49 H	133	57.8	2.4
4	11400.00	58.5 PK	74.0	-15.5	1.27 H	266	46.0	12.5
5	11400.00	49.1 AV	54.0	-4.9	1.27 H	266	36.6	12.5
6	#17100.00	63.0 PK	68.2	-5.2	1.26 H	318	46.2	16.8

Antenna Polarity & Test Distance : Vertical at 3 m

No	Frequency (MHz)	Emission Level (dBuV/m)	Limit (dBuV/m)	Margin (dB)	Antenna Height (m)	Table Angle (Degree)	Raw Value (dBuV)	Correction Factor (dB/m)
1	*5700.00	121.9 PK			1.44 V	287	119.6	2.3
2	*5700.00	112.1 AV			1.44 V	287	109.8	2.3
3	#5725.00	66.5 PK	68.2	-1.7	1.44 V	287	64.1	2.4
4	11400.00	58.6 PK	74.0	-15.4	2.22 V	286	46.1	12.5
5	11400.00	49.3 AV	54.0	-4.7	2.22 V	286	36.8	12.5
6	#17100.00	60.5 PK	68.2	-7.7	2.02 V	315	43.7	16.8

Remarks:

1. Emission Level(dBuV/m) = Raw Value(dBuV) + Correction Factor(dB/m)
2. Correction Factor(dB/m) = Antenna Factor(dB/m) + Cable Factor(dB) – Pre-Amplifier Factor(dB)
3. Margin value = Emission Level – Limit value
4. The other emission levels were very low against the limit.
5. " * ": Fundamental frequency.
6. " # ": The radiated frequency is out of the restricted band.

RF Mode	TX 20MHz Preamble 802.11ax (RU26)	Channel	CH 144 : 5720 MHz
Frequency Range	1GHz ~ 40GHz	Detector Function	Peak (PK) Average (AV)

Antenna Polarity & Test Distance : Horizontal at 3 m

No	Frequency (MHz)	Emission Level (dBuV/m)	Limit (dBuV/m)	Margin (dB)	Antenna Height (m)	Table Angle (Degree)	Raw Value (dBuV)	Correction Factor (dB/m)
1	5460.00	51.2 PK	74.0	-22.8	1.44 H	145	49.1	2.1
2	5460.00	38.2 AV	54.0	-15.8	1.44 H	145	36.1	2.1
3	#5470.00	51.7 PK	68.2	-16.5	1.44 H	145	49.5	2.2
4	*5720.00	115.2 PK			1.44 H	145	112.8	2.4
5	*5720.00	101.1 AV			1.44 H	145	98.7	2.4
6	#5850.00	51.2 PK	68.2	-17.0	1.44 H	145	48.5	2.7
7	11440.00	58.7 PK	74.0	-15.3	1.27 H	296	46.3	12.4
8	11440.00	49.2 AV	54.0	-4.8	1.27 H	296	36.8	12.4
9	#17160.00	62.9 PK	68.2	-5.3	1.32 H	332	46.3	16.6

Antenna Polarity & Test Distance : Vertical at 3 m

No	Frequency (MHz)	Emission Level (dBuV/m)	Limit (dBuV/m)	Margin (dB)	Antenna Height (m)	Table Angle (Degree)	Raw Value (dBuV)	Correction Factor (dB/m)
1	5460.00	51.9 PK	74.0	-22.1	1.48 V	286	49.8	2.1
2	5460.00	39.0 AV	54.0	-15.0	1.48 V	286	36.9	2.1
3	#5470.00	52.1 PK	68.2	-16.1	1.48 V	286	49.9	2.2
4	*5720.00	125.2 PK			1.48 V	286	122.8	2.4
5	*5720.00	114.1 AV			1.48 V	286	111.7	2.4
6	#5850.00	52.2 PK	68.2	-16.0	1.48 V	286	49.5	2.7
7	11440.00	58.8 PK	74.0	-15.2	2.25 V	290	46.4	12.4
8	11440.00	49.5 AV	54.0	-4.5	2.25 V	290	37.1	12.4
9	#17160.00	61.5 PK	68.2	-6.7	1.96 V	310	44.9	16.6

Remarks:

1. Emission Level(dBuV/m) = Raw Value(dBuV) + Correction Factor(dB/m)
2. Correction Factor(dB/m) = Antenna Factor(dB/m) + Cable Factor(dB) – Pre-Amplifier Factor(dB)
3. Margin value = Emission Level – Limit value
4. The other emission levels were very low against the limit.
5. " * ": Fundamental frequency.
6. " # ": The radiated frequency is out of the restricted band.

RF Mode	TX 20MHz Preamble 802.11ax (RU26)	Channel	CH 149 : 5745 MHz
Frequency Range	1GHz ~ 40GHz	Detector Function	Peak (PK) Average (AV)

Antenna Polarity & Test Distance : Horizontal at 3 m

No	Frequency (MHz)	Emission Level (dBuV/m)	Limit (dBuV/m)	Margin (dB)	Antenna Height (m)	Table Angle (Degree)	Raw Value (dBuV)	Correction Factor (dB/m)
1	#5572.61	50.1 PK	68.2	-18.1	1.33 H	135	48.0	2.1
2	*5745.00	112.9 PK			1.33 H	135	110.5	2.4
3	*5745.00	102.5 AV			1.33 H	135	100.1	2.4
4	#5941.66	50.2 PK	68.2	-18.0	1.33 H	135	47.3	2.9
5	11490.00	58.3 PK	74.0	-15.7	1.22 H	283	45.7	12.6
6	11490.00	48.3 AV	54.0	-5.7	1.22 H	283	35.7	12.6
7	#17235.00	64.8 PK	68.2	-3.4	1.28 H	339	48.0	16.8

Antenna Polarity & Test Distance : Vertical at 3 m

No	Frequency (MHz)	Emission Level (dBuV/m)	Limit (dBuV/m)	Margin (dB)	Antenna Height (m)	Table Angle (Degree)	Raw Value (dBuV)	Correction Factor (dB/m)
1	#5637.73	51.2 PK	68.2	-17.0	1.43 V	288	48.9	2.3
2	*5745.00	126.3 PK			1.43 V	288	123.9	2.4
3	*5745.00	115.7 AV			1.43 V	288	113.3	2.4
4	#5978.16	51.5 PK	68.2	-16.7	1.43 V	288	48.6	2.9
5	11490.00	59.1 PK	74.0	-14.9	2.18 V	262	46.5	12.6
6	11490.00	49.7 AV	54.0	-4.3	2.18 V	262	37.1	12.6
7	#17235.00	62.9 PK	68.2	-5.3	2.02 V	327	46.1	16.8

Remarks:

1. Emission Level(dBuV/m) = Raw Value(dBuV) + Correction Factor(dB/m)
2. Correction Factor(dB/m) = Antenna Factor(dB/m) + Cable Factor(dB) – Pre-Amplifier Factor(dB)
3. Margin value = Emission Level – Limit value
4. The other emission levels were very low against the limit.
5. " * ": Fundamental frequency.
6. " # ": The radiated frequency is out of the restricted band.

RF Mode	TX 20MHz Preamble 802.11ax (RU26)	Channel	CH 157 : 5785 MHz
Frequency Range	1GHz ~ 40GHz	Detector Function	Peak (PK) Average (AV)

Antenna Polarity & Test Distance : Horizontal at 3 m

No	Frequency (MHz)	Emission Level (dBuV/m)	Limit (dBuV/m)	Margin (dB)	Antenna Height (m)	Table Angle (Degree)	Raw Value (dBuV)	Correction Factor (dB/m)
1	#5582.63	51.3 PK	68.2	-16.9	1.39 H	132	49.2	2.1
2	*5785.00	113.2 PK			1.39 H	132	110.6	2.6
3	*5785.00	102.8 AV			1.39 H	132	100.2	2.6
4	#5952.38	51.1 PK	68.2	-17.1	1.39 H	132	48.2	2.9
5	11570.00	59.3 PK	74.0	-14.7	1.18 H	294	46.7	12.6
6	11570.00	49.8 AV	54.0	-4.2	1.18 H	294	37.2	12.6
7	#17355.00	64.7 PK	68.2	-3.5	1.32 H	323	47.0	17.7

Antenna Polarity & Test Distance : Vertical at 3 m

No	Frequency (MHz)	Emission Level (dBuV/m)	Limit (dBuV/m)	Margin (dB)	Antenna Height (m)	Table Angle (Degree)	Raw Value (dBuV)	Correction Factor (dB/m)
1	#5583.80	52.2 PK	68.2	-16.0	1.49 V	290	50.1	2.1
2	*5785.00	125.9 PK			1.49 V	290	123.3	2.6
3	*5785.00	116.4 AV			1.49 V	290	113.8	2.6
4	#5942.97	52.8 PK	68.2	-15.4	1.49 V	290	49.9	2.9
5	11570.00	59.8 PK	74.0	-14.2	2.26 V	279	47.2	12.6
6	11570.00	50.9 AV	54.0	-3.1	2.26 V	279	38.3	12.6
7	#17355.00	63.3 PK	68.2	-4.9	1.90 V	314	45.6	17.7

Remarks:

1. Emission Level(dBuV/m) = Raw Value(dBuV) + Correction Factor(dB/m)
2. Correction Factor(dB/m) = Antenna Factor(dB/m) + Cable Factor(dB) – Pre-Amplifier Factor(dB)
3. Margin value = Emission Level – Limit value
4. The other emission levels were very low against the limit.
5. " * ": Fundamental frequency.
6. " # ": The radiated frequency is out of the restricted band.

RF Mode	TX 20MHz Preamble 802.11ax (RU26)	Channel	CH 165 : 5825 MHz
Frequency Range	1GHz ~ 40GHz	Detector Function	Peak (PK) Average (AV)

Antenna Polarity & Test Distance : Horizontal at 3 m

No	Frequency (MHz)	Emission Level (dBuV/m)	Limit (dBuV/m)	Margin (dB)	Antenna Height (m)	Table Angle (Degree)	Raw Value (dBuV)	Correction Factor (dB/m)
1	#5645.59	51.6 PK	68.2	-16.6	1.43 H	140	49.3	2.3
2	*5825.00	111.8 PK			1.43 H	140	109.2	2.6
3	*5825.00	101.5 AV			1.43 H	140	98.9	2.6
4	#5944.88	50.8 PK	68.2	-17.4	1.43 H	140	47.9	2.9
5	11650.00	58.9 PK	74.0	-15.1	1.20 H	291	46.7	12.2
6	11650.00	48.6 AV	54.0	-5.4	1.20 H	291	36.4	12.2
7	#17475.00	64.5 PK	68.2	-3.7	1.30 H	316	45.8	18.7

Antenna Polarity & Test Distance : Vertical at 3 m

No	Frequency (MHz)	Emission Level (dBuV/m)	Limit (dBuV/m)	Margin (dB)	Antenna Height (m)	Table Angle (Degree)	Raw Value (dBuV)	Correction Factor (dB/m)
1	#5586.08	53.2 PK	68.2	-15.0	1.53 V	282	51.1	2.1
2	*5825.00	124.8 PK			1.53 V	282	122.2	2.6
3	*5825.00	115.1 AV			1.53 V	282	112.5	2.6
4	#5933.92	53.5 PK	68.2	-14.7	1.53 V	282	50.6	2.9
5	11650.00	59.8 PK	74.0	-14.2	2.16 V	275	47.6	12.2
6	11650.00	50.0 AV	54.0	-4.0	2.16 V	275	37.8	12.2
7	#17475.00	62.4 PK	68.2	-5.8	1.96 V	329	43.7	18.7

Remarks:

1. Emission Level(dBuV/m) = Raw Value(dBuV) + Correction Factor(dB/m)
2. Correction Factor(dB/m) = Antenna Factor(dB/m) + Cable Factor(dB) – Pre-Amplifier Factor(dB)
3. Margin value = Emission Level – Limit value
4. The other emission levels were very low against the limit.
5. " * ": Fundamental frequency.
6. " # ": The radiated frequency is out of the restricted band.

RF Mode	TX 20MHz Preamble 802.11ax (RU52)	Channel	CH 36 : 5180 MHz
Frequency Range	1GHz ~ 40GHz	Detector Function	Peak (PK) Average (AV)

Antenna Polarity & Test Distance : Horizontal at 3 m

No	Frequency (MHz)	Emission Level (dBuV/m)	Limit (dBuV/m)	Margin (dB)	Antenna Height (m)	Table Angle (Degree)	Raw Value (dBuV)	Correction Factor (dB/m)
1	5147.93	57.9 PK	74.0	-16.1	1.33 H	133	55.6	2.3
2	5147.93	39.8 AV	54.0	-14.2	1.33 H	133	37.5	2.3
3	*5180.00	112.7 PK			1.33 H	133	110.5	2.2
4	*5180.00	100.8 AV			1.33 H	133	98.6	2.2
5	#10360.00	56.8 PK	68.2	-11.4	1.00 H	300	45.0	11.8
6	15540.00	60.7 PK	74.0	-13.3	1.27 H	320	48.9	11.8
7	15540.00	48.6 AV	54.0	-5.4	1.27 H	320	36.8	11.8

Antenna Polarity & Test Distance : Vertical at 3 m

No	Frequency (MHz)	Emission Level (dBuV/m)	Limit (dBuV/m)	Margin (dB)	Antenna Height (m)	Table Angle (Degree)	Raw Value (dBuV)	Correction Factor (dB/m)
1	5150.00	63.4 PK	74.0	-10.6	1.49 V	284	61.1	2.3
2	5150.00	46.1 AV	54.0	-7.9	1.49 V	284	43.8	2.3
3	*5180.00	122.7 PK			1.49 V	284	120.5	2.2
4	*5180.00	112.2 AV			1.49 V	284	110.0	2.2
5	#10360.00	57.1 PK	68.2	-11.1	3.75 V	211	45.3	11.8
6	15540.00	59.0 PK	74.0	-15.0	2.32 V	244	47.2	11.8
7	15540.00	46.9 AV	54.0	-7.1	2.32 V	244	35.1	11.8

Remarks:

1. Emission Level(dBuV/m) = Raw Value(dBuV) + Correction Factor(dB/m)
2. Correction Factor(dB/m) = Antenna Factor(dB/m) + Cable Factor(dB) – Pre-Amplifier Factor(dB)
3. Margin value = Emission Level – Limit value
4. The other emission levels were very low against the limit.
5. " * ": Fundamental frequency.
6. " # ": The radiated frequency is out of the restricted band.

RF Mode	TX 20MHz Preamble 802.11ax (RU52)	Channel	CH 40 : 5200 MHz
Frequency Range	1GHz ~ 40GHz	Detector Function	Peak (PK) Average (AV)

Antenna Polarity & Test Distance : Horizontal at 3 m

No	Frequency (MHz)	Emission Level (dBuV/m)	Limit (dBuV/m)	Margin (dB)	Antenna Height (m)	Table Angle (Degree)	Raw Value (dBuV)	Correction Factor (dB/m)
1	5150.00	52.0 PK	74.0	-22.0	1.28 H	133	49.7	2.3
2	5150.00	41.2 AV	54.0	-12.8	1.28 H	133	38.9	2.3
3	*5200.00	112.3 PK			1.28 H	133	110.2	2.1
4	*5200.00	100.6 AV			1.28 H	133	98.5	2.1
5	#10400.00	57.3 PK	68.2	-10.9	1.07 H	301	45.3	12.0
6	15600.00	60.5 PK	74.0	-13.5	1.30 H	306	49.0	11.5
7	15600.00	48.3 AV	54.0	-5.7	1.30 H	306	36.8	11.5

Antenna Polarity & Test Distance : Vertical at 3 m

No	Frequency (MHz)	Emission Level (dBuV/m)	Limit (dBuV/m)	Margin (dB)	Antenna Height (m)	Table Angle (Degree)	Raw Value (dBuV)	Correction Factor (dB/m)
1	5150.00	52.6 PK	74.0	-21.4	1.45 V	271	50.3	2.3
2	5150.00	42.2 AV	54.0	-11.8	1.45 V	271	39.9	2.3
3	*5200.00	122.1 PK			1.45 V	271	120.0	2.1
4	*5200.00	111.8 AV			1.45 V	271	109.7	2.1
5	#10400.00	57.0 PK	68.2	-11.2	3.76 V	226	45.0	12.0
6	15600.00	58.8 PK	74.0	-15.2	2.29 V	246	47.3	11.5
7	15600.00	46.5 AV	54.0	-7.5	2.29 V	246	35.0	11.5

Remarks:

1. Emission Level(dBuV/m) = Raw Value(dBuV) + Correction Factor(dB/m)
2. Correction Factor(dB/m) = Antenna Factor(dB/m) + Cable Factor(dB) – Pre-Amplifier Factor(dB)
3. Margin value = Emission Level – Limit value
4. The other emission levels were very low against the limit.
5. " * ": Fundamental frequency.
6. " # ": The radiated frequency is out of the restricted band.

RF Mode	TX 20MHz Preamble 802.11ax (RU52)	Channel	CH 48 : 5240 MHz
Frequency Range	1GHz ~ 40GHz	Detector Function	Peak (PK) Average (AV)

Antenna Polarity & Test Distance : Horizontal at 3 m

No	Frequency (MHz)	Emission Level (dBuV/m)	Limit (dBuV/m)	Margin (dB)	Antenna Height (m)	Table Angle (Degree)	Raw Value (dBuV)	Correction Factor (dB/m)
1	5150.00	52.8 PK	74.0	-21.2	1.36 H	128	50.5	2.3
2	5150.00	38.3 AV	54.0	-15.7	1.36 H	128	36.0	2.3
3	*5240.00	112.7 PK			1.36 H	128	110.7	2.0
4	*5240.00	100.7 AV			1.36 H	128	98.7	2.0
5	5350.00	50.7 PK	74.0	-23.3	1.36 H	128	48.8	1.9
6	5350.00	37.7 AV	54.0	-16.3	1.36 H	128	35.8	1.9
7	#10480.00	56.5 PK	68.2	-11.7	1.01 H	309	44.6	11.9
8	15720.00	60.9 PK	74.0	-13.1	1.24 H	333	49.1	11.8
9	15720.00	48.7 AV	54.0	-5.3	1.24 H	333	36.9	11.8

Antenna Polarity & Test Distance : Vertical at 3 m

No	Frequency (MHz)	Emission Level (dBuV/m)	Limit (dBuV/m)	Margin (dB)	Antenna Height (m)	Table Angle (Degree)	Raw Value (dBuV)	Correction Factor (dB/m)
1	5150.00	52.7 PK	74.0	-21.3	1.55 V	270	50.4	2.3
2	5150.00	39.1 AV	54.0	-14.9	1.55 V	270	36.8	2.3
3	*5240.00	122.2 PK			1.55 V	270	120.2	2.0
4	*5240.00	111.9 AV			1.55 V	270	109.9	2.0
5	5350.00	50.9 PK	74.0	-23.1	1.55 V	270	49.0	1.9
6	5350.00	38.3 AV	54.0	-15.7	1.55 V	270	36.4	1.9
7	#10480.00	56.7 PK	68.2	-11.5	3.77 V	208	44.8	11.9
8	15720.00	59.4 PK	74.0	-14.6	2.29 V	249	47.6	11.8
9	15720.00	47.2 AV	54.0	-6.8	2.29 V	249	35.4	11.8

Remarks:

1. Emission Level(dBuV/m) = Raw Value(dBuV) + Correction Factor(dB/m)
2. Correction Factor(dB/m) = Antenna Factor(dB/m) + Cable Factor(dB) – Pre-Amplifier Factor(dB)
3. Margin value = Emission Level – Limit value
4. The other emission levels were very low against the limit.
5. " * ": Fundamental frequency.
6. " # ": The radiated frequency is out of the restricted band.

RF Mode	TX 20MHz Preamble 802.11ax (RU52)	Channel	CH 52 : 5260 MHz
Frequency Range	1GHz ~ 40GHz	Detector Function	Peak (PK) Average (AV)

Antenna Polarity & Test Distance : Horizontal at 3 m

No	Frequency (MHz)	Emission Level (dBuV/m)	Limit (dBuV/m)	Margin (dB)	Antenna Height (m)	Table Angle (Degree)	Raw Value (dBuV)	Correction Factor (dB/m)
1	5150.00	53.0 PK	74.0	-21.0	1.34 H	124	50.7	2.3
2	5150.00	38.5 AV	54.0	-15.5	1.34 H	124	36.2	2.3
3	*5260.00	112.8 PK			1.34 H	124	110.8	2.0
4	*5260.00	101.0 AV			1.34 H	124	99.0	2.0
5	5350.00	50.7 PK	74.0	-23.3	1.34 H	124	48.8	1.9
6	5350.00	37.9 AV	54.0	-16.1	1.34 H	124	36.0	1.9
7	#10520.00	56.7 PK	68.2	-11.5	1.02 H	286	44.7	12.0
8	15780.00	60.5 PK	74.0	-13.5	1.23 H	325	49.0	11.5
9	15780.00	48.3 AV	54.0	-5.7	1.23 H	325	36.8	11.5

Antenna Polarity & Test Distance : Vertical at 3 m

No	Frequency (MHz)	Emission Level (dBuV/m)	Limit (dBuV/m)	Margin (dB)	Antenna Height (m)	Table Angle (Degree)	Raw Value (dBuV)	Correction Factor (dB/m)
1	5150.00	52.4 PK	74.0	-21.6	1.47 V	294	50.1	2.3
2	5150.00	38.9 AV	54.0	-15.1	1.47 V	294	36.6	2.3
3	*5260.00	122.2 PK			1.47 V	294	120.2	2.0
4	*5260.00	112.1 AV			1.47 V	294	110.1	2.0
5	5350.00	51.3 PK	74.0	-22.7	1.47 V	294	49.4	1.9
6	5350.00	38.6 AV	54.0	-15.4	1.47 V	294	36.7	1.9
7	#10520.00	56.9 PK	68.2	-11.3	3.81 V	214	44.9	12.0
8	15780.00	59.4 PK	74.0	-14.6	2.37 V	257	47.9	11.5
9	15780.00	47.2 AV	54.0	-6.8	2.37 V	257	35.7	11.5

Remarks:

1. Emission Level(dBuV/m) = Raw Value(dBuV) + Correction Factor(dB/m)
2. Correction Factor(dB/m) = Antenna Factor(dB/m) + Cable Factor(dB) – Pre-Amplifier Factor(dB)
3. Margin value = Emission Level – Limit value
4. The other emission levels were very low against the limit.
5. " * ": Fundamental frequency.
6. " # ": The radiated frequency is out of the restricted band.

RF Mode	TX 20MHz Preamble 802.11ax (RU52)	Channel	CH 60 : 5300 MHz
Frequency Range	1GHz ~ 40GHz	Detector Function	Peak (PK) Average (AV)

Antenna Polarity & Test Distance : Horizontal at 3 m

No	Frequency (MHz)	Emission Level (dBuV/m)	Limit (dBuV/m)	Margin (dB)	Antenna Height (m)	Table Angle (Degree)	Raw Value (dBuV)	Correction Factor (dB/m)
1	*5300.00	113.0 PK			1.30 H	134	111.3	1.7
2	*5300.00	101.0 AV			1.30 H	134	99.3	1.7
3	5350.00	51.0 PK	74.0	-23.0	1.30 H	134	49.1	1.9
4	5350.00	40.6 AV	54.0	-13.4	1.30 H	134	38.7	1.9
5	10600.00	57.1 PK	74.0	-16.9	1.08 H	300	45.2	11.9
6	10600.00	46.2 AV	54.0	-7.8	1.08 H	300	34.3	11.9
7	15900.00	60.0 PK	74.0	-14.0	1.31 H	332	48.7	11.3
8	15900.00	48.2 AV	54.0	-5.8	1.31 H	332	36.9	11.3

Antenna Polarity & Test Distance : Vertical at 3 m

No	Frequency (MHz)	Emission Level (dBuV/m)	Limit (dBuV/m)	Margin (dB)	Antenna Height (m)	Table Angle (Degree)	Raw Value (dBuV)	Correction Factor (dB/m)
1	*5300.00	122.1 PK			1.44 V	296	120.4	1.7
2	*5300.00	111.8 AV			1.44 V	296	110.1	1.7
3	5350.00	52.6 PK	74.0	-21.4	1.44 V	296	50.7	1.9
4	5350.00	41.7 AV	54.0	-12.3	1.44 V	296	39.8	1.9
5	10600.00	57.0 PK	74.0	-17.0	3.69 V	207	45.1	11.9
6	10600.00	45.6 AV	54.0	-8.4	3.69 V	207	33.7	11.9
7	15900.00	59.4 PK	74.0	-14.6	2.30 V	249	48.1	11.3
8	15900.00	47.2 AV	54.0	-6.8	2.30 V	249	35.9	11.3

Remarks:

1. Emission Level(dBuV/m) = Raw Value(dBuV) + Correction Factor(dB/m)
2. Correction Factor(dB/m) = Antenna Factor(dB/m) + Cable Factor(dB) – Pre-Amplifier Factor(dB)
3. Margin value = Emission Level – Limit value
4. The other emission levels were very low against the limit.
5. " * ": Fundamental frequency.

RF Mode	TX 20MHz Preamble 802.11ax (RU52)	Channel	CH 64 : 5320 MHz
Frequency Range	1GHz ~ 40GHz	Detector Function	Peak (PK) Average (AV)

Antenna Polarity & Test Distance : Horizontal at 3 m

No	Frequency (MHz)	Emission Level (dBuV/m)	Limit (dBuV/m)	Margin (dB)	Antenna Height (m)	Table Angle (Degree)	Raw Value (dBuV)	Correction Factor (dB/m)
1	*5320.00	111.8 PK			1.28 H	141	110.0	1.8
2	*5320.00	100.1 AV			1.28 H	141	98.3	1.8
3	5350.00	60.1 PK	74.0	-13.9	1.28 H	141	58.2	1.9
4	5350.00	39.5 AV	54.0	-14.5	1.28 H	141	37.6	1.9
5	10640.00	56.7 PK	74.0	-17.3	1.05 H	314	44.9	11.8
6	10640.00	45.7 AV	54.0	-8.3	1.05 H	314	33.9	11.8
7	15960.00	60.6 PK	74.0	-13.4	1.21 H	323	49.0	11.6
8	15960.00	48.2 AV	54.0	-5.8	1.21 H	323	36.6	11.6

Antenna Polarity & Test Distance : Vertical at 3 m

No	Frequency (MHz)	Emission Level (dBuV/m)	Limit (dBuV/m)	Margin (dB)	Antenna Height (m)	Table Angle (Degree)	Raw Value (dBuV)	Correction Factor (dB/m)
1	*5320.00	123.4 PK			1.51 V	277	121.6	1.8
2	*5320.00	112.3 AV			1.51 V	277	110.5	1.8
3	5350.00	70.4 PK	74.0	-3.6	1.51 V	277	68.5	1.9
4	5350.00	46.2 AV	54.0	-7.8	1.51 V	277	44.3	1.9
5	5367.80	55.5 PK	74.0	-18.5	1.51 V	277	53.5	2.0
6	5367.80	46.4 AV	54.0	-7.6	1.51 V	277	44.4	2.0
7	10640.00	56.8 PK	74.0	-17.2	3.76 V	198	45.0	11.8
8	10640.00	45.5 AV	54.0	-8.5	3.76 V	198	33.7	11.8
9	15960.00	59.2 PK	74.0	-14.8	2.34 V	254	47.6	11.6
10	15960.00	47.2 AV	54.0	-6.8	2.34 V	254	35.6	11.6

Remarks:

1. Emission Level(dBuV/m) = Raw Value(dBuV) + Correction Factor(dB/m)
2. Correction Factor(dB/m) = Antenna Factor(dB/m) + Cable Factor(dB) – Pre-Amplifier Factor(dB)
3. Margin value = Emission Level – Limit value
4. The other emission levels were very low against the limit.
5. " * ": Fundamental frequency.

RF Mode	TX 20MHz Preamble 802.11ax (RU52)	Channel	CH 100 : 5500 MHz
Frequency Range	1GHz ~ 40GHz	Detector Function	Peak (PK) Average (AV)

Antenna Polarity & Test Distance : Horizontal at 3 m

No	Frequency (MHz)	Emission Level (dBuV/m)	Limit (dBuV/m)	Margin (dB)	Antenna Height (m)	Table Angle (Degree)	Raw Value (dBuV)	Correction Factor (dB/m)
1	5457.74	49.8 PK	74.0	-24.2	1.32 H	134	47.7	2.1
2	5457.74	38.9 AV	54.0	-15.1	1.32 H	134	36.8	2.1
3	#5467.62	55.3 PK	68.2	-12.9	1.32 H	134	53.1	2.2
4	*5500.00	110.3 PK			1.32 H	134	108.2	2.1
5	*5500.00	100.4 AV			1.32 H	134	98.3	2.1
6	11000.00	56.3 PK	74.0	-17.7	1.05 H	300	43.9	12.4
7	11000.00	45.6 AV	54.0	-8.4	1.05 H	300	33.2	12.4
8	#16500.00	61.2 PK	68.2	-7.0	1.24 H	316	47.5	13.7

Antenna Polarity & Test Distance : Vertical at 3 m

No	Frequency (MHz)	Emission Level (dBuV/m)	Limit (dBuV/m)	Margin (dB)	Antenna Height (m)	Table Angle (Degree)	Raw Value (dBuV)	Correction Factor (dB/m)
1	5454.20	55.6 PK	74.0	-18.4	1.48 V	275	53.5	2.1
2	5454.20	44.5 AV	54.0	-9.5	1.48 V	275	42.4	2.1
3	5458.40	56.9 PK	74.0	-17.1	1.48 V	275	54.8	2.1
4	5458.40	43.2 AV	54.0	-10.8	1.48 V	275	41.1	2.1
5	#5467.00	59.6 PK	68.2	-8.6	1.48 V	275	57.4	2.2
6	*5500.00	122.5 PK			1.48 V	275	120.4	2.1
7	*5500.00	112.1 AV			1.48 V	275	110.0	2.1
8	11000.00	56.8 PK	74.0	-17.2	3.69 V	197	44.4	12.4
9	11000.00	45.6 AV	54.0	-8.4	3.69 V	197	33.2	12.4
10	#16500.00	58.9 PK	68.2	-9.3	2.31 V	235	45.2	13.7

Remarks:

1. Emission Level(dBuV/m) = Raw Value(dBuV) + Correction Factor(dB/m)
2. Correction Factor(dB/m) = Antenna Factor(dB/m) + Cable Factor(dB) – Pre-Amplifier Factor(dB)
3. Margin value = Emission Level – Limit value
4. The other emission levels were very low against the limit.
5. " * ": Fundamental frequency.
6. " # ": The radiated frequency is out of the restricted band.

RF Mode	TX 20MHz Preamble 802.11ax (RU52)	Channel	CH 116 : 5580 MHz
Frequency Range	1GHz ~ 40GHz	Detector Function	Peak (PK) Average (AV)

Antenna Polarity & Test Distance : Horizontal at 3 m

No	Frequency (MHz)	Emission Level (dBuV/m)	Limit (dBuV/m)	Margin (dB)	Antenna Height (m)	Table Angle (Degree)	Raw Value (dBuV)	Correction Factor (dB/m)
1	*5580.00	112.5 PK			1.34 H	141	110.4	2.1
2	*5580.00	100.5 AV			1.34 H	141	98.4	2.1
3	11160.00	57.1 PK	74.0	-16.9	1.07 H	310	45.1	12.0
4	11160.00	46.1 AV	54.0	-7.9	1.07 H	310	34.1	12.0
5	#16740.00	60.8 PK	68.2	-7.4	1.25 H	323	45.5	15.3

Antenna Polarity & Test Distance : Vertical at 3 m

No	Frequency (MHz)	Emission Level (dBuV/m)	Limit (dBuV/m)	Margin (dB)	Antenna Height (m)	Table Angle (Degree)	Raw Value (dBuV)	Correction Factor (dB/m)
1	*5580.00	124.8 PK			1.44 V	281	122.7	2.1
2	*5580.00	113.3 AV			1.44 V	281	111.2	2.1
3	11160.00	57.1 PK	74.0	-16.9	3.74 V	221	45.1	12.0
4	11160.00	46.0 AV	54.0	-8.0	3.74 V	221	34.0	12.0
5	#16740.00	59.1 PK	68.2	-9.1	2.27 V	239	43.8	15.3

Remarks:

1. Emission Level(dBuV/m) = Raw Value(dBuV) + Correction Factor(dB/m)
2. Correction Factor(dB/m) = Antenna Factor(dB/m) + Cable Factor(dB) – Pre-Amplifier Factor(dB)
3. Margin value = Emission Level – Limit value
4. The other emission levels were very low against the limit.
5. " * ": Fundamental frequency.
6. " # ": The radiated frequency is out of the restricted band.

RF Mode	TX 20MHz Preamble 802.11ax (RU52)	Channel	CH 140 : 5700 MHz
Frequency Range	1GHz ~ 40GHz	Detector Function	Peak (PK) Average (AV)

Antenna Polarity & Test Distance : Horizontal at 3 m

No	Frequency (MHz)	Emission Level (dBuV/m)	Limit (dBuV/m)	Margin (dB)	Antenna Height (m)	Table Angle (Degree)	Raw Value (dBuV)	Correction Factor (dB/m)
1	*5700.00	109.8 PK			1.35 H	145	107.5	2.3
2	*5700.00	99.7 AV			1.35 H	145	97.4	2.3
3	#5725.00	61.3 PK	68.2	-6.9	1.35 H	145	58.9	2.4
4	11400.00	56.7 PK	74.0	-17.3	1.06 H	312	44.2	12.5
5	11400.00	45.5 AV	54.0	-8.5	1.06 H	312	33.0	12.5
6	#17100.00	60.8 PK	68.2	-7.4	1.21 H	330	44.0	16.8

Antenna Polarity & Test Distance : Vertical at 3 m

No	Frequency (MHz)	Emission Level (dBuV/m)	Limit (dBuV/m)	Margin (dB)	Antenna Height (m)	Table Angle (Degree)	Raw Value (dBuV)	Correction Factor (dB/m)
1	*5700.00	123.6 PK			1.52 V	282	121.3	2.3
2	*5700.00	112.7 AV			1.52 V	282	110.4	2.3
3	#5728.00	66.6 PK	68.2	-1.6	1.52 V	282	64.1	2.5
4	11400.00	57.7 PK	74.0	-16.3	3.79 V	223	45.2	12.5
5	11400.00	46.2 AV	54.0	-7.8	3.79 V	223	33.7	12.5
6	#17100.00	59.5 PK	68.2	-8.7	2.31 V	239	42.7	16.8

Remarks:

1. Emission Level(dBuV/m) = Raw Value(dBuV) + Correction Factor(dB/m)
2. Correction Factor(dB/m) = Antenna Factor(dB/m) + Cable Factor(dB) – Pre-Amplifier Factor(dB)
3. Margin value = Emission Level – Limit value
4. The other emission levels were very low against the limit.
5. " * " : Fundamental frequency.
6. " # " : The radiated frequency is out of the restricted band.

RF Mode	TX 20MHz Preamble 802.11ax (RU52)	Channel	CH 144 : 5720 MHz
Frequency Range	1GHz ~ 40GHz	Detector Function	Peak (PK) Average (AV)

Antenna Polarity & Test Distance : Horizontal at 3 m

No	Frequency (MHz)	Emission Level (dBuV/m)	Limit (dBuV/m)	Margin (dB)	Antenna Height (m)	Table Angle (Degree)	Raw Value (dBuV)	Correction Factor (dB/m)
1	5460.00	51.8 PK	74.0	-22.2	1.35 H	126	49.7	2.1
2	5460.00	38.7 AV	54.0	-15.3	1.35 H	126	36.6	2.1
3	#5470.00	51.8 PK	68.2	-16.4	1.35 H	126	49.6	2.2
4	*5720.00	112.4 PK			1.35 H	126	110.0	2.4
5	*5720.00	100.8 AV			1.35 H	126	98.4	2.4
6	#5850.00	50.8 PK	68.2	-17.4	1.35 H	126	48.1	2.7
7	11440.00	57.1 PK	74.0	-16.9	1.09 H	286	44.7	12.4
8	11440.00	46.3 AV	54.0	-7.7	1.09 H	286	33.9	12.4
9	#17160.00	60.4 PK	68.2	-7.8	1.30 H	312	43.8	16.6

Antenna Polarity & Test Distance : Vertical at 3 m

No	Frequency (MHz)	Emission Level (dBuV/m)	Limit (dBuV/m)	Margin (dB)	Antenna Height (m)	Table Angle (Degree)	Raw Value (dBuV)	Correction Factor (dB/m)
1	5460.00	51.6 PK	74.0	-22.4	1.51 V	300	49.5	2.1
2	5460.00	38.6 AV	54.0	-15.4	1.51 V	300	36.5	2.1
3	#5470.00	51.9 PK	68.2	-16.3	1.51 V	300	49.7	2.2
4	*5720.00	124.5 PK			1.51 V	300	122.1	2.4
5	*5720.00	113.2 AV			1.51 V	300	110.8	2.4
6	#5850.00	51.2 PK	68.2	-17.0	1.51 V	300	48.5	2.7
7	11440.00	57.0 PK	74.0	-17.0	3.73 V	216	44.6	12.4
8	11440.00	45.9 AV	54.0	-8.1	3.73 V	216	33.5	12.4
9	#17160.00	58.7 PK	68.2	-9.5	2.36 V	251	42.1	16.6

Remarks:

1. Emission Level(dBuV/m) = Raw Value(dBuV) + Correction Factor(dB/m)
2. Correction Factor(dB/m) = Antenna Factor(dB/m) + Cable Factor(dB) – Pre-Amplifier Factor(dB)
3. Margin value = Emission Level – Limit value
4. The other emission levels were very low against the limit.
5. " * ": Fundamental frequency.
6. " # ": The radiated frequency is out of the restricted band.

RF Mode	TX 20MHz Preamble 802.11ax (RU52)	Channel	CH 149 : 5745 MHz
Frequency Range	1GHz ~ 40GHz	Detector Function	Peak (PK) Average (AV)

Antenna Polarity & Test Distance : Horizontal at 3 m

No	Frequency (MHz)	Emission Level (dBuV/m)	Limit (dBuV/m)	Margin (dB)	Antenna Height (m)	Table Angle (Degree)	Raw Value (dBuV)	Correction Factor (dB/m)
1	#5631.12	50.9 PK	68.2	-17.3	1.29 H	146	48.6	2.3
2	*5745.00	111.9 PK			1.29 H	146	109.5	2.4
3	*5745.00	100.5 AV			1.29 H	146	98.1	2.4
4	#5983.15	51.3 PK	68.2	-16.9	1.29 H	146	48.4	2.9
5	11490.00	59.4 PK	74.0	-14.6	1.04 H	304	46.8	12.6
6	11490.00	48.6 AV	54.0	-5.4	1.04 H	304	36.0	12.6
7	#17235.00	64.0 PK	68.2	-4.2	1.32 H	316	47.2	16.8

Antenna Polarity & Test Distance : Vertical at 3 m

No	Frequency (MHz)	Emission Level (dBuV/m)	Limit (dBuV/m)	Margin (dB)	Antenna Height (m)	Table Angle (Degree)	Raw Value (dBuV)	Correction Factor (dB/m)
1	#5603.59	51.7 PK	68.2	-16.5	1.68 V	279	49.6	2.1
2	*5745.00	125.1 PK			1.68 V	279	122.7	2.4
3	*5745.00	113.6 AV			1.68 V	279	111.2	2.4
4	#6011.43	51.9 PK	68.2	-16.3	1.68 V	279	49.0	2.9
5	11490.00	58.3 PK	74.0	-15.7	3.99 V	197	45.7	12.6
6	11490.00	47.7 AV	54.0	-6.3	3.99 V	197	35.1	12.6
7	#17235.00	60.3 PK	68.2	-7.9	2.41 V	229	43.5	16.8

Remarks:

1. Emission Level(dBuV/m) = Raw Value(dBuV) + Correction Factor(dB/m)
2. Correction Factor(dB/m) = Antenna Factor(dB/m) + Cable Factor(dB) – Pre-Amplifier Factor(dB)
3. Margin value = Emission Level – Limit value
4. The other emission levels were very low against the limit.
5. " * ": Fundamental frequency.
6. " # ": The radiated frequency is out of the restricted band.

RF Mode	TX 20MHz Preamble 802.11ax (RU52)	Channel	CH 157 : 5785 MHz
Frequency Range	1GHz ~ 40GHz	Detector Function	Peak (PK) Average (AV)

Antenna Polarity & Test Distance : Horizontal at 3 m

No	Frequency (MHz)	Emission Level (dBuV/m)	Limit (dBuV/m)	Margin (dB)	Antenna Height (m)	Table Angle (Degree)	Raw Value (dBuV)	Correction Factor (dB/m)
1	#5573.87	50.9 PK	68.2	-17.3	1.38 H	131	48.8	2.1
2	*5785.00	111.3 PK			1.38 H	131	108.7	2.6
3	*5785.00	100.3 AV			1.38 H	131	97.7	2.6
4	#5972.47	51.3 PK	68.2	-16.9	1.38 H	131	48.4	2.9
5	11570.00	57.9 PK	74.0	-16.1	1.05 H	297	45.3	12.6
6	11570.00	46.0 AV	54.0	-8.0	1.05 H	297	33.4	12.6
7	#17355.00	64.3 PK	68.2	-3.9	1.30 H	315	46.6	17.7

Antenna Polarity & Test Distance : Vertical at 3 m

No	Frequency (MHz)	Emission Level (dBuV/m)	Limit (dBuV/m)	Margin (dB)	Antenna Height (m)	Table Angle (Degree)	Raw Value (dBuV)	Correction Factor (dB/m)
1	#5588.51	51.7 PK	68.2	-16.5	1.63 V	284	49.6	2.1
2	*5785.00	124.6 PK			1.63 V	284	122.0	2.6
3	*5785.00	113.3 AV			1.63 V	284	110.7	2.6
4	#5950.45	52.5 PK	68.2	-15.7	1.63 V	284	49.6	2.9
5	11570.00	58.1 PK	74.0	-15.9	3.98 V	184	45.5	12.6
6	11570.00	47.6 AV	54.0	-6.4	3.98 V	184	35.0	12.6
7	#17355.00	60.7 PK	68.2	-7.5	2.36 V	230	43.0	17.7

Remarks:

1. Emission Level(dBuV/m) = Raw Value(dBuV) + Correction Factor(dB/m)
2. Correction Factor(dB/m) = Antenna Factor(dB/m) + Cable Factor(dB) – Pre-Amplifier Factor(dB)
3. Margin value = Emission Level – Limit value
4. The other emission levels were very low against the limit.
5. " * ": Fundamental frequency.
6. " # ": The radiated frequency is out of the restricted band.

RF Mode	TX 20MHz Preamble 802.11ax (RU52)	Channel	CH 165 : 5825 MHz
Frequency Range	1GHz ~ 40GHz	Detector Function	Peak (PK) Average (AV)

Antenna Polarity & Test Distance : Horizontal at 3 m

No	Frequency (MHz)	Emission Level (dBuV/m)	Limit (dBuV/m)	Margin (dB)	Antenna Height (m)	Table Angle (Degree)	Raw Value (dBuV)	Correction Factor (dB/m)
1	#5616.71	50.7 PK	68.2	-17.5	1.37 H	147	48.6	2.1
2	*5825.00	121.3 PK			1.37 H	147	118.7	2.6
3	*5825.00	100.8 AV			1.37 H	147	98.2	2.6
4	#5966.03	51.0 PK	68.2	-17.2	1.37 H	147	48.1	2.9
5	11650.00	53.9 PK	74.0	-20.1	1.09 H	305	41.7	12.2
6	11650.00	43.8 AV	54.0	-10.2	1.09 H	305	31.6	12.2
7	#17475.00	64.9 PK	68.2	-3.3	1.32 H	325	46.2	18.7

Antenna Polarity & Test Distance : Vertical at 3 m

No	Frequency (MHz)	Emission Level (dBuV/m)	Limit (dBuV/m)	Margin (dB)	Antenna Height (m)	Table Angle (Degree)	Raw Value (dBuV)	Correction Factor (dB/m)
1	#5564.70	52.4 PK	68.2	-15.8	1.59 V	275	50.3	2.1
2	*5825.00	124.9 PK			1.59 V	275	122.3	2.6
3	*5825.00	114.6 AV			1.59 V	275	112.0	2.6
4	#5935.08	52.5 PK	68.2	-15.7	1.59 V	275	49.6	2.9
5	11650.00	58.9 PK	74.0	-15.1	3.98 V	195	46.7	12.2
6	11650.00	48.1 AV	54.0	-5.9	3.98 V	195	35.9	12.2
7	#17475.00	60.8 PK	68.2	-7.4	2.39 V	238	42.1	18.7

Remarks:

1. Emission Level(dBuV/m) = Raw Value(dBuV) + Correction Factor(dB/m)
2. Correction Factor(dB/m) = Antenna Factor(dB/m) + Cable Factor(dB) – Pre-Amplifier Factor(dB)
3. Margin value = Emission Level – Limit value
4. The other emission levels were very low against the limit.
5. " * ": Fundamental frequency.
6. " # ": The radiated frequency is out of the restricted band.

RF Mode	TX 20MHz Preamble 802.11ax (RU106)	Channel	CH 36 : 5180 MHz
Frequency Range	1GHz ~ 40GHz	Detector Function	Peak (PK) Average (AV)

Antenna Polarity & Test Distance : Horizontal at 3 m

No	Frequency (MHz)	Emission Level (dBuV/m)	Limit (dBuV/m)	Margin (dB)	Antenna Height (m)	Table Angle (Degree)	Raw Value (dBuV)	Correction Factor (dB/m)
1	5150.00	51.4 PK	74.0	-22.6	1.21 H	135	49.1	2.3
2	5150.00	40.3 AV	54.0	-13.7	1.21 H	135	38.0	2.3
3	*5180.00	109.6 PK			1.21 H	135	107.4	2.2
4	*5180.00	99.3 AV			1.21 H	135	97.1	2.2
5	#10360.00	52.6 PK	68.2	-15.6	1.04 H	301	40.8	11.8
6	15540.00	57.3 PK	74.0	-16.7	1.16 H	341	45.5	11.8
7	15540.00	44.9 AV	54.0	-9.1	1.16 H	341	33.1	11.8

Antenna Polarity & Test Distance : Vertical at 3 m

No	Frequency (MHz)	Emission Level (dBuV/m)	Limit (dBuV/m)	Margin (dB)	Antenna Height (m)	Table Angle (Degree)	Raw Value (dBuV)	Correction Factor (dB/m)
1	5150.00	57.6 PK	74.0	-16.4	1.46 V	281	55.3	2.3
2	5150.00	45.8 AV	54.0	-8.2	1.46 V	281	43.5	2.3
3	*5180.00	120.5 PK			1.46 V	281	118.3	2.2
4	*5180.00	109.5 AV			1.46 V	281	107.3	2.2
5	#10360.00	54.7 PK	68.2	-13.5	2.17 V	260	42.9	11.8
6	15540.00	58.5 PK	74.0	-15.5	2.25 V	306	46.7	11.8
7	15540.00	45.5 AV	54.0	-8.5	2.25 V	306	33.7	11.8

Remarks:

1. Emission Level(dBuV/m) = Raw Value(dBuV) + Correction Factor(dB/m)
2. Correction Factor(dB/m) = Antenna Factor(dB/m) + Cable Factor(dB) – Pre-Amplifier Factor(dB)
3. Margin value = Emission Level – Limit value
4. The other emission levels were very low against the limit.
5. " * ": Fundamental frequency.
6. " # ": The radiated frequency is out of the restricted band.

RF Mode	TX 20MHz Preamble 802.11ax (RU106)	Channel	CH 40 : 5200 MHz
Frequency Range	1GHz ~ 40GHz	Detector Function	Peak (PK) Average (AV)

Antenna Polarity & Test Distance : Horizontal at 3 m

No	Frequency (MHz)	Emission Level (dBuV/m)	Limit (dBuV/m)	Margin (dB)	Antenna Height (m)	Table Angle (Degree)	Raw Value (dBuV)	Correction Factor (dB/m)
1	5150.00	52.1 PK	74.0	-21.9	1.15 H	145	49.8	2.3
2	5150.00	41.2 AV	54.0	-12.8	1.15 H	145	38.9	2.3
3	*5200.00	109.0 PK			1.15 H	145	106.9	2.1
4	*5200.00	98.9 AV			1.15 H	145	96.8	2.1
5	#10400.00	52.3 PK	68.2	-15.9	1.00 H	297	40.3	12.0
6	15600.00	57.6 PK	74.0	-16.4	1.12 H	347	46.1	11.5
7	15600.00	45.3 AV	54.0	-8.7	1.12 H	347	33.8	11.5

Antenna Polarity & Test Distance : Vertical at 3 m

No	Frequency (MHz)	Emission Level (dBuV/m)	Limit (dBuV/m)	Margin (dB)	Antenna Height (m)	Table Angle (Degree)	Raw Value (dBuV)	Correction Factor (dB/m)
1	5150.00	53.4 PK	74.0	-20.6	1.48 V	293	51.1	2.3
2	5150.00	42.7 AV	54.0	-11.3	1.48 V	293	40.4	2.3
3	*5200.00	120.5 PK			1.48 V	293	118.4	2.1
4	*5200.00	109.5 AV			1.48 V	293	107.4	2.1
5	#10400.00	55.1 PK	68.2	-13.1	2.15 V	270	43.1	12.0
6	15600.00	58.4 PK	74.0	-15.6	2.24 V	309	46.9	11.5
7	15600.00	45.3 AV	54.0	-8.7	2.24 V	309	33.8	11.5

Remarks:

1. Emission Level(dBuV/m) = Raw Value(dBuV) + Correction Factor(dB/m)
2. Correction Factor(dB/m) = Antenna Factor(dB/m) + Cable Factor(dB) – Pre-Amplifier Factor(dB)
3. Margin value = Emission Level – Limit value
4. The other emission levels were very low against the limit.
5. " * ": Fundamental frequency.
6. " # ": The radiated frequency is out of the restricted band.

RF Mode	TX 20MHz Preamble 802.11ax (RU106)	Channel	CH 48 : 5240 MHz
Frequency Range	1GHz ~ 40GHz	Detector Function	Peak (PK) Average (AV)

Antenna Polarity & Test Distance : Horizontal at 3 m

No	Frequency (MHz)	Emission Level (dBuV/m)	Limit (dBuV/m)	Margin (dB)	Antenna Height (m)	Table Angle (Degree)	Raw Value (dBuV)	Correction Factor (dB/m)
1	5150.00	53.1 PK	74.0	-20.9	1.26 H	119	50.8	2.3
2	5150.00	38.7 AV	54.0	-15.3	1.26 H	119	36.4	2.3
3	*5240.00	109.5 PK			1.26 H	119	107.5	2.0
4	*5240.00	99.3 AV			1.26 H	119	97.3	2.0
5	5350.00	50.5 PK	74.0	-23.5	1.26 H	119	48.6	1.9
6	5350.00	37.4 AV	54.0	-16.6	1.26 H	119	35.5	1.9
7	#10480.00	52.0 PK	68.2	-16.2	1.08 H	290	40.1	11.9
8	15720.00	57.0 PK	74.0	-17.0	1.10 H	327	45.2	11.8
9	15720.00	44.9 AV	54.0	-9.1	1.10 H	327	33.1	11.8

Antenna Polarity & Test Distance : Vertical at 3 m

No	Frequency (MHz)	Emission Level (dBuV/m)	Limit (dBuV/m)	Margin (dB)	Antenna Height (m)	Table Angle (Degree)	Raw Value (dBuV)	Correction Factor (dB/m)
1	5150.00	52.2 PK	74.0	-21.8	1.49 V	293	49.9	2.3
2	5150.00	38.6 AV	54.0	-15.4	1.49 V	293	36.3	2.3
3	*5240.00	120.3 PK			1.49 V	293	118.3	2.0
4	*5240.00	109.4 AV			1.49 V	293	107.4	2.0
5	5350.00	51.0 PK	74.0	-23.0	1.49 V	293	49.1	1.9
6	5350.00	38.1 AV	54.0	-15.9	1.49 V	293	36.2	1.9
7	#10480.00	55.0 PK	68.2	-13.2	2.20 V	249	43.1	11.9
8	15720.00	58.4 PK	74.0	-15.6	2.23 V	291	46.6	11.8
9	15720.00	45.6 AV	54.0	-8.4	2.23 V	291	33.8	11.8

Remarks:

1. Emission Level(dBuV/m) = Raw Value(dBuV) + Correction Factor(dB/m)
2. Correction Factor(dB/m) = Antenna Factor(dB/m) + Cable Factor(dB) – Pre-Amplifier Factor(dB)
3. Margin value = Emission Level – Limit value
4. The other emission levels were very low against the limit.
5. " * ": Fundamental frequency.
6. " # ": The radiated frequency is out of the restricted band.

RF Mode	TX 20MHz Preamble 802.11ax (RU106)	Channel	CH 52 : 5260 MHz
Frequency Range	1GHz ~ 40GHz	Detector Function	Peak (PK) Average (AV)

Antenna Polarity & Test Distance : Horizontal at 3 m

No	Frequency (MHz)	Emission Level (dBuV/m)	Limit (dBuV/m)	Margin (dB)	Antenna Height (m)	Table Angle (Degree)	Raw Value (dBuV)	Correction Factor (dB/m)
1	5150.00	53.2 PK	74.0	-20.8	1.26 H	137	50.9	2.3
2	5150.00	38.6 AV	54.0	-15.4	1.26 H	137	36.3	2.3
3	*5260.00	110.0 PK			1.26 H	137	108.0	2.0
4	*5260.00	99.8 AV			1.26 H	137	97.8	2.0
5	5350.00	51.0 PK	74.0	-23.0	1.26 H	137	49.1	1.9
6	5350.00	37.9 AV	54.0	-16.1	1.26 H	137	36.0	1.9
7	#10520.00	51.8 PK	68.2	-16.4	1.07 H	276	39.8	12.0
8	15780.00	56.8 PK	74.0	-17.2	1.10 H	329	45.3	11.5
9	15780.00	44.9 AV	54.0	-9.1	1.10 H	329	33.4	11.5

Antenna Polarity & Test Distance : Vertical at 3 m

No	Frequency (MHz)	Emission Level (dBuV/m)	Limit (dBuV/m)	Margin (dB)	Antenna Height (m)	Table Angle (Degree)	Raw Value (dBuV)	Correction Factor (dB/m)
1	5150.00	52.5 PK	74.0	-21.5	1.49 V	281	50.2	2.3
2	5150.00	38.9 AV	54.0	-15.1	1.49 V	281	36.6	2.3
3	*5260.00	120.7 PK			1.49 V	281	118.7	2.0
4	*5260.00	109.7 AV			1.49 V	281	107.7	2.0
5	5350.00	50.6 PK	74.0	-23.4	1.49 V	281	48.7	1.9
6	5350.00	37.8 AV	54.0	-16.2	1.49 V	281	35.9	1.9
7	#10520.00	55.0 PK	68.2	-13.2	2.12 V	258	43.0	12.0
8	15780.00	58.2 PK	74.0	-15.8	2.26 V	299	46.7	11.5
9	15780.00	45.4 AV	54.0	-8.6	2.26 V	299	33.9	11.5

Remarks:

1. Emission Level(dBuV/m) = Raw Value(dBuV) + Correction Factor(dB/m)
2. Correction Factor(dB/m) = Antenna Factor(dB/m) + Cable Factor(dB) – Pre-Amplifier Factor(dB)
3. Margin value = Emission Level – Limit value
4. The other emission levels were very low against the limit.
5. " * ": Fundamental frequency.
6. " # ": The radiated frequency is out of the restricted band.

RF Mode	TX 20MHz Preamble 802.11ax (RU106)	Channel	CH 60 : 5300 MHz
Frequency Range	1GHz ~ 40GHz	Detector Function	Peak (PK) Average (AV)

Antenna Polarity & Test Distance : Horizontal at 3 m

No	Frequency (MHz)	Emission Level (dBuV/m)	Limit (dBuV/m)	Margin (dB)	Antenna Height (m)	Table Angle (Degree)	Raw Value (dBuV)	Correction Factor (dB/m)
1	*5300.00	109.5 PK			1.20 H	129	107.8	1.7
2	*5300.00	99.2 AV			1.20 H	129	97.5	1.7
3	5350.00	50.7 PK	74.0	-23.3	1.20 H	129	48.8	1.9
4	5350.00	40.4 AV	54.0	-13.6	1.20 H	129	38.5	1.9
5	10600.00	51.9 PK	74.0	-22.1	1.09 H	293	40.0	11.9
6	10600.00	40.2 AV	54.0	-13.8	1.09 H	293	28.3	11.9
7	15900.00	56.9 PK	74.0	-17.1	1.07 H	329	45.6	11.3
8	15900.00	44.5 AV	54.0	-9.5	1.07 H	329	33.2	11.3

Antenna Polarity & Test Distance : Vertical at 3 m

No	Frequency (MHz)	Emission Level (dBuV/m)	Limit (dBuV/m)	Margin (dB)	Antenna Height (m)	Table Angle (Degree)	Raw Value (dBuV)	Correction Factor (dB/m)
1	*5300.00	120.5 PK			1.45 V	293	118.8	1.7
2	*5300.00	109.4 AV			1.45 V	293	107.7	1.7
3	5350.00	52.4 PK	74.0	-21.6	1.45 V	293	50.5	1.9
4	5350.00	41.6 AV	54.0	-12.4	1.45 V	293	39.7	1.9
5	10600.00	54.5 PK	74.0	-19.5	2.20 V	245	42.6	11.9
6	10600.00	42.3 AV	54.0	-11.7	2.20 V	245	30.4	11.9
7	15900.00	57.8 PK	74.0	-16.2	2.21 V	292	46.5	11.3
8	15900.00	45.0 AV	54.0	-9.0	2.21 V	292	33.7	11.3

Remarks:

1. Emission Level(dBuV/m) = Raw Value(dBuV) + Correction Factor(dB/m)
2. Correction Factor(dB/m) = Antenna Factor(dB/m) + Cable Factor(dB) – Pre-Amplifier Factor(dB)
3. Margin value = Emission Level – Limit value
4. The other emission levels were very low against the limit.
5. " * ": Fundamental frequency.

RF Mode	TX 20MHz Preamble 802.11ax (RU106)	Channel	CH 64 : 5320 MHz
Frequency Range	1GHz ~ 40GHz	Detector Function	Peak (PK) Average (AV)

Antenna Polarity & Test Distance : Horizontal at 3 m

No	Frequency (MHz)	Emission Level (dBuV/m)	Limit (dBuV/m)	Margin (dB)	Antenna Height (m)	Table Angle (Degree)	Raw Value (dBuV)	Correction Factor (dB/m)
1	*5320.00	108.4 PK			1.38 H	140	106.6	1.8
2	*5320.00	98.4 AV			1.38 H	140	96.6	1.8
3	5350.00	55.7 PK	74.0	-18.3	1.38 H	140	53.8	1.9
4	5350.00	38.7 AV	54.0	-15.3	1.38 H	140	36.8	1.9
5	10640.00	52.2 PK	74.0	-21.8	1.04 H	288	40.4	11.8
6	10640.00	40.6 AV	54.0	-13.4	1.04 H	288	28.8	11.8
7	15960.00	57.5 PK	74.0	-16.5	1.13 H	312	45.9	11.6
8	15960.00	45.2 AV	54.0	-8.8	1.13 H	312	33.6	11.6

Antenna Polarity & Test Distance : Vertical at 3 m

No	Frequency (MHz)	Emission Level (dBuV/m)	Limit (dBuV/m)	Margin (dB)	Antenna Height (m)	Table Angle (Degree)	Raw Value (dBuV)	Correction Factor (dB/m)
1	*5320.00	120.4 PK			1.44 V	291	118.6	1.8
2	*5320.00	109.7 AV			1.44 V	291	107.9	1.8
3	5350.00	63.8 PK	74.0	-10.2	1.44 V	291	61.9	1.9
4	5350.00	44.1 AV	54.0	-9.9	1.44 V	291	42.2	1.9
5	10640.00	54.5 PK	74.0	-19.5	2.14 V	250	42.7	11.8
6	10640.00	42.2 AV	54.0	-11.8	2.14 V	250	30.4	11.8
7	15960.00	58.7 PK	74.0	-15.3	2.20 V	315	47.1	11.6
8	15960.00	45.5 AV	54.0	-8.5	2.20 V	315	33.9	11.6

Remarks:

1. Emission Level(dBuV/m) = Raw Value(dBuV) + Correction Factor(dB/m)
2. Correction Factor(dB/m) = Antenna Factor(dB/m) + Cable Factor(dB) – Pre-Amplifier Factor(dB)
3. Margin value = Emission Level – Limit value
4. The other emission levels were very low against the limit.
5. " * ": Fundamental frequency.

RF Mode	TX 20MHz Preamble 802.11ax (RU106)	Channel	CH 100 : 5500 MHz
Frequency Range	1GHz ~ 40GHz	Detector Function	Peak (PK) Average (AV)

Antenna Polarity & Test Distance : Horizontal at 3 m								
No	Frequency (MHz)	Emission Level (dBuV/m)	Limit (dBuV/m)	Margin (dB)	Antenna Height (m)	Table Angle (Degree)	Raw Value (dBuV)	Correction Factor (dB/m)
1	5433.80	50.0 PK	74.0	-24.0	1.27 H	143	47.9	2.1
2	5433.80	38.0 AV	54.0	-16.0	1.27 H	143	35.9	2.1
3	5458.50	49.3 PK	74.0	-24.7	1.27 H	143	47.2	2.1
4	5458.50	38.9 AV	54.0	-15.1	1.27 H	143	36.8	2.1
5	#5469.70	51.3 PK	68.2	-16.9	1.27 H	143	49.1	2.2
6	*5500.00	106.6 PK			1.27 H	143	104.5	2.1
7	*5500.00	96.8 AV			1.27 H	143	94.7	2.1
8	11000.00	52.3 PK	74.0	-21.7	1.02 H	295	39.9	12.4
9	11000.00	40.7 AV	54.0	-13.3	1.02 H	295	28.3	12.4
10	#16500.00	57.1 PK	68.2	-11.1	1.06 H	323	43.4	13.7
Antenna Polarity & Test Distance : Vertical at 3 m								
No	Frequency (MHz)	Emission Level (dBuV/m)	Limit (dBuV/m)	Margin (dB)	Antenna Height (m)	Table Angle (Degree)	Raw Value (dBuV)	Correction Factor (dB/m)
1	5458.00	57.3 PK	74.0	-16.7	1.34 V	278	55.2	2.1
2	5458.00	44.6 AV	54.0	-9.4	1.34 V	278	42.5	2.1
3	#5466.60	66.5 PK	68.2	-1.7	1.34 V	278	64.4	2.1
4	*5500.00	121.2 PK			1.34 V	278	119.1	2.1
5	*5500.00	110.0 AV			1.34 V	278	107.9	2.1
6	11000.00	55.2 PK	74.0	-18.8	2.21 V	266	42.8	12.4
7	11000.00	42.9 AV	54.0	-11.1	2.21 V	266	30.5	12.4
8	#16500.00	58.6 PK	68.2	-9.6	2.29 V	295	44.9	13.7

Remarks:

1. Emission Level(dBuV/m) = Raw Value(dBuV) + Correction Factor(dB/m)
2. Correction Factor(dB/m) = Antenna Factor(dB/m) + Cable Factor(dB) – Pre-Amplifier Factor(dB)
3. Margin value = Emission Level – Limit value
4. The other emission levels were very low against the limit.
5. " * ": Fundamental frequency.
6. " # ": The radiated frequency is out of the restricted band.

RF Mode	TX 20MHz Preamble 802.11ax (RU106)	Channel	CH 116 : 5580 MHz
Frequency Range	1GHz ~ 40GHz	Detector Function	Peak (PK) Average (AV)

Antenna Polarity & Test Distance : Horizontal at 3 m

No	Frequency (MHz)	Emission Level (dBuV/m)	Limit (dBuV/m)	Margin (dB)	Antenna Height (m)	Table Angle (Degree)	Raw Value (dBuV)	Correction Factor (dB/m)
1	*5580.00	109.7 PK			1.27 H	138	107.6	2.1
2	*5580.00	99.5 AV			1.27 H	138	97.4	2.1
3	11160.00	51.9 PK	74.0	-22.1	1.05 H	286	39.9	12.0
4	11160.00	40.7 AV	54.0	-13.3	1.05 H	286	28.7	12.0
5	#16740.00	56.6 PK	68.2	-11.6	1.06 H	331	41.3	15.3

Antenna Polarity & Test Distance : Vertical at 3 m

No	Frequency (MHz)	Emission Level (dBuV/m)	Limit (dBuV/m)	Margin (dB)	Antenna Height (m)	Table Angle (Degree)	Raw Value (dBuV)	Correction Factor (dB/m)
1	*5580.00	120.0 PK			1.41 V	277	117.9	2.1
2	*5580.00	109.0 AV			1.41 V	277	106.9	2.1
3	11160.00	54.6 PK	74.0	-19.4	2.13 V	252	42.6	12.0
4	11160.00	42.4 AV	54.0	-11.6	2.13 V	252	30.4	12.0
5	#16740.00	58.7 PK	68.2	-9.5	2.22 V	308	43.4	15.3

Remarks:

1. Emission Level(dBuV/m) = Raw Value(dBuV) + Correction Factor(dB/m)
2. Correction Factor(dB/m) = Antenna Factor(dB/m) + Cable Factor(dB) – Pre-Amplifier Factor(dB)
3. Margin value = Emission Level – Limit value
4. The other emission levels were very low against the limit.
5. " * ": Fundamental frequency.
6. " # ": The radiated frequency is out of the restricted band.

RF Mode	TX 20MHz Preamble 802.11ax (RU106)	Channel	CH 140 : 5700 MHz
Frequency Range	1GHz ~ 40GHz	Detector Function	Peak (PK) Average (AV)

Antenna Polarity & Test Distance : Horizontal at 3 m

No	Frequency (MHz)	Emission Level (dBuV/m)	Limit (dBuV/m)	Margin (dB)	Antenna Height (m)	Table Angle (Degree)	Raw Value (dBuV)	Correction Factor (dB/m)
1	*5700.00	106.9 PK			1.34 H	137	104.6	2.3
2	*5700.00	96.5 AV			1.34 H	137	94.2	2.3
3	#5725.00	54.2 PK	68.2	-14.0	1.34 H	137	51.8	2.4
4	11400.00	51.5 PK	74.0	-22.5	1.02 H	303	39.0	12.5
5	11400.00	40.2 AV	54.0	-13.8	1.02 H	303	27.7	12.5
6	#17100.00	56.7 PK	68.2	-11.5	1.11 H	315	39.9	16.8

Antenna Polarity & Test Distance : Vertical at 3 m

No	Frequency (MHz)	Emission Level (dBuV/m)	Limit (dBuV/m)	Margin (dB)	Antenna Height (m)	Table Angle (Degree)	Raw Value (dBuV)	Correction Factor (dB/m)
1	*5700.00	120.3 PK			1.47 V	280	118.0	2.3
2	*5700.00	109.8 AV			1.47 V	280	107.5	2.3
3	#5725.00	66.7 PK	68.2	-1.5	1.47 V	280	64.3	2.4
4	11400.00	55.2 PK	74.0	-18.8	2.15 V	249	42.7	12.5
5	11400.00	43.0 AV	54.0	-11.0	2.15 V	249	30.5	12.5
6	#17100.00	59.0 PK	68.2	-9.2	2.23 V	291	42.2	16.8

Remarks:

1. Emission Level(dBuV/m) = Raw Value(dBuV) + Correction Factor(dB/m)
2. Correction Factor(dB/m) = Antenna Factor(dB/m) + Cable Factor(dB) – Pre-Amplifier Factor(dB)
3. Margin value = Emission Level – Limit value
4. The other emission levels were very low against the limit.
5. " * ": Fundamental frequency.
6. " # ": The radiated frequency is out of the restricted band.

RF Mode	TX 20MHz Preamble 802.11ax (RU106)	Channel	CH 144 : 5720 MHz
Frequency Range	1GHz ~ 40GHz	Detector Function	Peak (PK) Average (AV)

Antenna Polarity & Test Distance : Horizontal at 3 m

No	Frequency (MHz)	Emission Level (dBuV/m)	Limit (dBuV/m)	Margin (dB)	Antenna Height (m)	Table Angle (Degree)	Raw Value (dBuV)	Correction Factor (dB/m)
1	5460.00	51.3 PK	74.0	-22.7	1.19 H	138	49.2	2.1
2	5460.00	38.4 AV	54.0	-15.6	1.19 H	138	36.3	2.1
3	#5470.00	52.0 PK	68.2	-16.2	1.19 H	138	49.8	2.2
4	*5720.00	110.2 PK			1.19 H	138	107.8	2.4
5	*5720.00	99.6 AV			1.19 H	138	97.2	2.4
6	#5850.00	50.9 PK	68.2	-17.3	1.19 H	138	48.2	2.7
7	11440.00	51.7 PK	74.0	-22.3	1.07 H	305	39.3	12.4
8	11440.00	40.4 AV	54.0	-13.6	1.07 H	305	28.0	12.4
9	#17160.00	56.7 PK	68.2	-11.5	1.08 H	332	40.1	16.6

Antenna Polarity & Test Distance : Vertical at 3 m

No	Frequency (MHz)	Emission Level (dBuV/m)	Limit (dBuV/m)	Margin (dB)	Antenna Height (m)	Table Angle (Degree)	Raw Value (dBuV)	Correction Factor (dB/m)
1	5460.00	50.5 PK	74.0	-23.5	1.51 V	283	48.4	2.1
2	5460.00	38.2 AV	54.0	-15.8	1.51 V	283	36.1	2.1
3	#5470.00	51.6 PK	68.2	-16.6	1.51 V	283	49.4	2.2
4	*5720.00	121.2 PK			1.51 V	283	118.8	2.4
5	*5720.00	110.3 AV			1.51 V	283	107.9	2.4
6	#5850.00	51.4 PK	68.2	-16.8	1.51 V	283	48.7	2.7
7	11440.00	54.5 PK	74.0	-19.5	2.21 V	248	42.1	12.4
8	11440.00	42.5 AV	54.0	-11.5	2.21 V	248	30.1	12.4
9	#17160.00	58.1 PK	68.2	-10.1	2.28 V	308	41.5	16.6

Remarks:

1. Emission Level(dBuV/m) = Raw Value(dBuV) + Correction Factor(dB/m)
2. Correction Factor(dB/m) = Antenna Factor(dB/m) + Cable Factor(dB) – Pre-Amplifier Factor(dB)
3. Margin value = Emission Level – Limit value
4. The other emission levels were very low against the limit.
5. " * ": Fundamental frequency.
6. " # ": The radiated frequency is out of the restricted band.

RF Mode	TX 20MHz Preamble 802.11ax (RU106)	Channel	CH 149 : 5745 MHz
Frequency Range	1GHz ~ 40GHz	Detector Function	Peak (PK) Average (AV)

Antenna Polarity & Test Distance : Horizontal at 3 m

No	Frequency (MHz)	Emission Level (dBuV/m)	Limit (dBuV/m)	Margin (dB)	Antenna Height (m)	Table Angle (Degree)	Raw Value (dBuV)	Correction Factor (dB/m)
1	#5639.03	51.1 PK	68.2	-17.1	1.21 H	147	48.8	2.3
2	*5745.00	109.6 PK			1.21 H	147	107.2	2.4
3	*5745.00	100.2 AV			1.21 H	147	97.8	2.4
4	#5979.48	51.2 PK	68.2	-17.0	1.21 H	147	48.3	2.9
5	11490.00	53.8 PK	74.0	-20.2	1.10 H	270	41.2	12.6
6	11490.00	42.3 AV	54.0	-11.7	1.10 H	270	29.7	12.6
7	#17235.00	58.7 PK	68.2	-9.5	1.22 H	348	41.9	16.8

Antenna Polarity & Test Distance : Vertical at 3 m

No	Frequency (MHz)	Emission Level (dBuV/m)	Limit (dBuV/m)	Margin (dB)	Antenna Height (m)	Table Angle (Degree)	Raw Value (dBuV)	Correction Factor (dB/m)
1	#5638.26	53.0 PK	68.2	-15.2	1.50 V	286	50.7	2.3
2	*5745.00	122.5 PK			1.50 V	286	120.1	2.4
3	*5745.00	111.4 AV			1.50 V	286	109.0	2.4
4	#5998.20	51.4 PK	68.2	-16.8	1.50 V	286	48.5	2.9
5	11490.00	56.4 PK	74.0	-17.6	2.09 V	242	43.8	12.6
6	11490.00	44.1 AV	54.0	-9.9	2.09 V	242	31.5	12.6
7	#17235.00	60.3 PK	68.2	-7.9	1.42 V	0	43.5	16.8

Remarks:

1. Emission Level(dBuV/m) = Raw Value(dBuV) + Correction Factor(dB/m)
2. Correction Factor(dB/m) = Antenna Factor(dB/m) + Cable Factor(dB) – Pre-Amplifier Factor(dB)
3. Margin value = Emission Level – Limit value
4. The other emission levels were very low against the limit.
5. " * ": Fundamental frequency.
6. " # ": The radiated frequency is out of the restricted band.

RF Mode	TX 20MHz Preamble 802.11ax (RU106)	Channel	CH 157 : 5785 MHz
Frequency Range	1GHz ~ 40GHz	Detector Function	Peak (PK) Average (AV)

Antenna Polarity & Test Distance : Horizontal at 3 m

No	Frequency (MHz)	Emission Level (dBuV/m)	Limit (dBuV/m)	Margin (dB)	Antenna Height (m)	Table Angle (Degree)	Raw Value (dBuV)	Correction Factor (dB/m)
1	#5602.37	50.9 PK	68.2	-17.3	1.36 H	148	48.8	2.1
2	*5785.00	108.7 PK			1.36 H	148	106.1	2.6
3	*5785.00	100.0 AV			1.36 H	148	97.4	2.6
4	#6013.92	51.1 PK	68.2	-17.1	1.36 H	148	48.2	2.9
5	11570.00	52.6 PK	74.0	-21.4	1.14 H	281	40.0	12.6
6	11570.00	41.0 AV	54.0	-13.0	1.14 H	281	28.4	12.6
7	#17355.00	57.2 PK	68.2	-11.0	1.12 H	321	39.5	17.7

Antenna Polarity & Test Distance : Vertical at 3 m

No	Frequency (MHz)	Emission Level (dBuV/m)	Limit (dBuV/m)	Margin (dB)	Antenna Height (m)	Table Angle (Degree)	Raw Value (dBuV)	Correction Factor (dB/m)
1	#5646.83	53.2 PK	68.2	-15.0	1.59 V	273	50.9	2.3
2	*5785.00	122.5 PK			1.59 V	273	119.9	2.6
3	*5785.00	111.8 AV			1.59 V	273	109.2	2.6
4	#5929.34	52.8 PK	68.2	-15.4	1.59 V	273	49.9	2.9
5	11570.00	55.6 PK	74.0	-18.4	2.15 V	276	43.0	12.6
6	11570.00	43.2 AV	54.0	-10.8	2.15 V	276	30.6	12.6
7	#17355.00	59.6 PK	68.2	-8.6	2.27 V	315	41.9	17.7

Remarks:

1. Emission Level(dBuV/m) = Raw Value(dBuV) + Correction Factor(dB/m)
2. Correction Factor(dB/m) = Antenna Factor(dB/m) + Cable Factor(dB) – Pre-Amplifier Factor(dB)
3. Margin value = Emission Level – Limit value
4. The other emission levels were very low against the limit.
5. " * ": Fundamental frequency.
6. " # ": The radiated frequency is out of the restricted band.

RF Mode	TX 20MHz Preamble 802.11ax (RU106)	Channel	CH 165 : 5825 MHz
Frequency Range	1GHz ~ 40GHz	Detector Function	Peak (PK) Average (AV)

Antenna Polarity & Test Distance : Horizontal at 3 m

No	Frequency (MHz)	Emission Level (dBuV/m)	Limit (dBuV/m)	Margin (dB)	Antenna Height (m)	Table Angle (Degree)	Raw Value (dBuV)	Correction Factor (dB/m)
1	#5594.22	50.6 PK	68.2	-17.6	1.12 H	144	48.5	2.1
2	*5825.00	109.9 PK			1.12 H	144	107.3	2.6
3	*5825.00	100.7 AV			1.12 H	144	98.1	2.6
4	#5976.09	52.1 PK	68.2	-16.1	1.12 H	144	49.2	2.9
5	11650.00	53.3 PK	74.0	-20.7	1.04 H	300	41.1	12.2
6	11650.00	42.2 AV	54.0	-11.8	1.04 H	300	30.0	12.2
7	#17475.00	58.1 PK	68.2	-10.1	1.14 H	328	39.4	18.7

Antenna Polarity & Test Distance : Vertical at 3 m

No	Frequency (MHz)	Emission Level (dBuV/m)	Limit (dBuV/m)	Margin (dB)	Antenna Height (m)	Table Angle (Degree)	Raw Value (dBuV)	Correction Factor (dB/m)
1	#5591.27	52.9 PK	68.2	-15.3	1.58 V	277	50.8	2.1
2	*5825.00	122.9 PK			1.58 V	277	120.3	2.6
3	*5825.00	112.3 AV			1.58 V	277	109.7	2.6
4	#5932.49	53.8 PK	68.2	-14.4	1.58 V	277	50.9	2.9
5	11650.00	56.1 PK	74.0	-17.9	2.15 V	248	43.9	12.2
6	11650.00	43.8 AV	54.0	-10.2	2.15 V	248	31.6	12.2
7	#17475.00	59.3 PK	68.2	-8.9	2.24 V	320	40.6	18.7

Remarks:

1. Emission Level(dBuV/m) = Raw Value(dBuV) + Correction Factor(dB/m)
2. Correction Factor(dB/m) = Antenna Factor(dB/m) + Cable Factor(dB) – Pre-Amplifier Factor(dB)
3. Margin value = Emission Level – Limit value
4. The other emission levels were very low against the limit.
5. " * ": Fundamental frequency.
6. " # ": The radiated frequency is out of the restricted band.

Below 1GHz Data:

RF Mode	TX 802.11a	Channel	CH 157 : 5785 MHz
Frequency Range	9kHz ~ 1GHz	Detector Function	Quasi-Peak (QP)

Antenna Polarity & Test Distance : Horizontal at 3 m								
No	Frequency (MHz)	Emission Level (dBuV/m)	Limit (dBuV/m)	Margin (dB)	Antenna Height (m)	Table Angle (Degree)	Raw Value (dBuV)	Correction Factor (dB/m)
1	120.27	38.3 QP	43.5	-5.2	3.00 H	337	53.3	-15.0
2	166.80	35.1 QP	43.5	-8.4	2.00 H	133	48.1	-13.0
3	226.74	33.5 QP	46.0	-12.5	2.00 H	134	49.4	-15.9
4	299.47	35.0 QP	46.0	-11.0	1.50 H	72	47.3	-12.3
5	336.92	33.8 QP	46.0	-12.2	1.50 H	337	45.1	-11.3
6	574.54	26.6 QP	46.0	-19.4	1.50 H	118	32.8	-6.2

Remarks:

1. Emission Level(dBuV/m) = Raw Value(dBuV) + Correction Factor(dB/m)
2. Correction Factor(dB/m) = Antenna Factor(dB/m) + Cable Factor(dB) – Pre-Amplifier Factor(dB)
3. Margin value = Emission Level – Limit value
4. The other emission levels were very low against the limit of frequency range 30MHz~1000MHz.
5. The emission levels were very low against the limit of frequency range 9kHz~30MHz: the amplitude of spurious emissions attenuated more than 20 dB below the permissible value to be report.

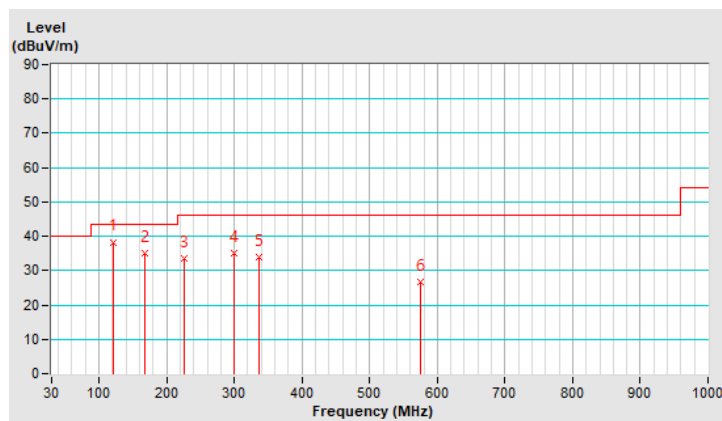

RF Mode	TX 802.11a	Channel	CH 157 : 5785 MHz
Frequency Range	9kHz ~ 1GHz	Detector Function	Quasi-Peak (QP)

Antenna Polarity & Test Distance : Vertical at 3 m

No	Frequency (MHz)	Emission Level (dBuV/m)	Limit (dBuV/m)	Margin (dB)	Antenna Height (m)	Table Angle (Degree)	Raw Value (dBuV)	Correction Factor (dB/m)
1	125.62	28.7 QP	43.5	-14.8	1.00 V	30	43.2	-14.5
2	166.71	32.0 QP	43.5	-11.5	1.50 V	230	45.0	-13.0
3	223.86	31.6 QP	46.0	-14.4	1.00 V	149	47.6	-16.0
4	341.38	26.7 QP	46.0	-19.3	1.50 V	190	38.0	-11.3
5	498.77	24.5 QP	46.0	-21.5	1.50 V	47	32.1	-7.6
6	950.44	33.2 QP	46.0	-12.8	1.00 V	149	33.8	-0.6

Remarks:

1. Emission Level(dBuV/m) = Raw Value(dBuV) + Correction Factor(dB/m)
2. Correction Factor(dB/m) = Antenna Factor(dB/m) + Cable Factor(dB) – Pre-Amplifier Factor(dB)
3. Margin value = Emission Level – Limit value
4. The other emission levels were very low against the limit of frequency range 30MHz~1000MHz.
5. The emission levels were very low against the limit of frequency range 9kHz~30MHz: the amplitude of spurious emissions attenuated more than 20 dB below the permissible value to be report.

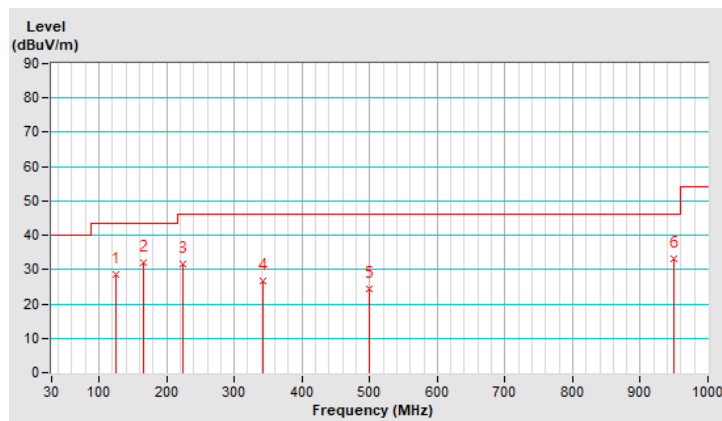

PIFA Antenna

Above 1GHz Data:

RF Mode	TX 802.11a	Channel	CH 36 : 5180 MHz
Frequency Range	1GHz ~ 40GHz	Detector Function	Peak (PK) Average (AV)

Antenna Polarity & Test Distance : Horizontal at 3 m

No	Frequency (MHz)	Emission Level (dBuV/m)	Limit (dBuV/m)	Margin (dB)	Antenna Height (m)	Table Angle (Degree)	Raw Value (dBuV)	Correction Factor (dB/m)
1	5150.00	70.7 PK	74.0	-3.3	2.13 H	126	68.4	2.3
2	5150.00	52.4 AV	54.0	-1.6	2.13 H	126	50.1	2.3
3	*5180.00	118.2 PK			2.13 H	126	116.0	2.2
4	*5180.00	108.2 AV			2.13 H	126	106.0	2.2
5	#10360.00	54.8 PK	68.2	-13.4	1.12 H	346	43.0	11.8
6	15540.00	59.2 PK	74.0	-14.8	1.46 H	289	47.4	11.8
7	15540.00	46.3 AV	54.0	-7.7	1.46 H	289	34.5	11.8

Antenna Polarity & Test Distance : Vertical at 3 m

No	Frequency (MHz)	Emission Level (dBuV/m)	Limit (dBuV/m)	Margin (dB)	Antenna Height (m)	Table Angle (Degree)	Raw Value (dBuV)	Correction Factor (dB/m)
1	5150.00	67.2 PK	74.0	-6.8	1.24 V	135	64.9	2.3
2	5150.00	47.1 AV	54.0	-6.9	1.24 V	135	44.8	2.3
3	*5180.00	111.1 PK			1.24 V	135	108.9	2.2
4	*5180.00	101.2 AV			1.24 V	135	99.0	2.2
5	#10360.00	55.1 PK	68.2	-13.1	2.22 V	176	43.3	11.8
6	15540.00	59.8 PK	74.0	-14.2	1.65 V	267	48.0	11.8
7	15540.00	47.8 AV	54.0	-6.2	1.65 V	267	36.0	11.8

Remarks:

1. Emission Level(dBuV/m) = Raw Value(dBuV) + Correction Factor(dB/m)
2. Correction Factor(dB/m) = Antenna Factor(dB/m) + Cable Factor(dB) – Pre-Amplifier Factor(dB)
3. Margin value = Emission Level – Limit value
4. The other emission levels were very low against the limit.
5. " * ": Fundamental frequency.
6. " # ": The radiated frequency is out of the restricted band.

RF Mode	TX 802.11a	Channel	CH 40 : 5200 MHz
Frequency Range	1GHz ~ 40GHz	Detector Function	Peak (PK) Average (AV)

Antenna Polarity & Test Distance : Horizontal at 3 m

No	Frequency (MHz)	Emission Level (dBuV/m)	Limit (dBuV/m)	Margin (dB)	Antenna Height (m)	Table Angle (Degree)	Raw Value (dBuV)	Correction Factor (dB/m)
1	5150.00	64.3 PK	74.0	-9.7	2.14 H	113	62.0	2.3
2	5150.00	45.0 AV	54.0	-9.0	2.14 H	113	42.7	2.3
3	*5200.00	118.7 PK			2.14 H	113	116.6	2.1
4	*5200.00	108.6 AV			2.14 H	113	106.5	2.1
5	#10400.00	54.7 PK	68.2	-13.5	1.08 H	360	42.7	12.0
6	15600.00	58.7 PK	74.0	-15.3	1.40 H	277	47.2	11.5
7	15600.00	46.2 AV	54.0	-7.8	1.40 H	277	34.7	11.5

Antenna Polarity & Test Distance : Vertical at 3 m

No	Frequency (MHz)	Emission Level (dBuV/m)	Limit (dBuV/m)	Margin (dB)	Antenna Height (m)	Table Angle (Degree)	Raw Value (dBuV)	Correction Factor (dB/m)
1	5150.00	61.2 PK	74.0	-12.8	1.27 V	124	58.9	2.3
2	5150.00	43.2 AV	54.0	-10.8	1.27 V	124	40.9	2.3
3	*5200.00	112.3 PK			1.27 V	124	110.2	2.1
4	*5200.00	102.4 AV			1.27 V	124	100.3	2.1
5	#10400.00	54.3 PK	68.2	-13.9	2.23 V	179	42.3	12.0
6	15600.00	59.6 PK	74.0	-14.4	1.59 V	282	48.1	11.5
7	15600.00	47.7 AV	54.0	-6.3	1.59 V	282	36.2	11.5

Remarks:

1. Emission Level(dBuV/m) = Raw Value(dBuV) + Correction Factor(dB/m)
2. Correction Factor(dB/m) = Antenna Factor(dB/m) + Cable Factor(dB) – Pre-Amplifier Factor(dB)
3. Margin value = Emission Level – Limit value
4. The other emission levels were very low against the limit.
5. " * ": Fundamental frequency.
6. " # ": The radiated frequency is out of the restricted band.

RF Mode	TX 802.11a	Channel	CH 48 : 5240 MHz
Frequency Range	1GHz ~ 40GHz	Detector Function	Peak (PK) Average (AV)

Antenna Polarity & Test Distance : Horizontal at 3 m

No	Frequency (MHz)	Emission Level (dBuV/m)	Limit (dBuV/m)	Margin (dB)	Antenna Height (m)	Table Angle (Degree)	Raw Value (dBuV)	Correction Factor (dB/m)
1	5150.00	51.3 PK	74.0	-22.7	2.10 H	105	49.0	2.3
2	5150.00	39.7 AV	54.0	-14.3	2.10 H	105	37.4	2.3
3	*5240.00	118.9 PK			2.10 H	105	116.9	2.0
4	*5240.00	108.7 AV			2.10 H	105	106.7	2.0
5	5350.00	51.1 PK	74.0	-22.9	2.10 H	105	49.2	1.9
6	5350.00	39.1 AV	54.0	-14.9	2.10 H	105	37.2	1.9
7	#10480.00	54.6 PK	68.2	-13.6	1.06 H	360	42.7	11.9
8	15720.00	58.3 PK	74.0	-15.7	1.41 H	270	46.5	11.8
9	15720.00	45.8 AV	54.0	-8.2	1.41 H	270	34.0	11.8

Antenna Polarity & Test Distance : Vertical at 3 m

No	Frequency (MHz)	Emission Level (dBuV/m)	Limit (dBuV/m)	Margin (dB)	Antenna Height (m)	Table Angle (Degree)	Raw Value (dBuV)	Correction Factor (dB/m)
1	5150.00	50.8 PK	74.0	-23.2	1.23 V	139	48.5	2.3
2	5150.00	38.1 AV	54.0	-15.9	1.23 V	139	35.8	2.3
3	*5240.00	112.3 PK			1.23 V	139	110.3	2.0
4	*5240.00	102.2 AV			1.23 V	139	100.2	2.0
5	5350.00	49.8 PK	74.0	-24.2	1.23 V	139	47.9	1.9
6	5350.00	37.8 AV	54.0	-16.2	1.23 V	139	35.9	1.9
7	#10480.00	54.8 PK	68.2	-13.4	2.24 V	178	42.9	11.9
8	15720.00	59.9 PK	74.0	-14.1	1.60 V	283	48.1	11.8
9	15720.00	47.9 AV	54.0	-6.1	1.60 V	283	36.1	11.8

Remarks:

1. Emission Level(dBuV/m) = Raw Value(dBuV) + Correction Factor(dB/m)
2. Correction Factor(dB/m) = Antenna Factor(dB/m) + Cable Factor(dB) – Pre-Amplifier Factor(dB)
3. Margin value = Emission Level – Limit value
4. The other emission levels were very low against the limit.
5. " * ": Fundamental frequency.
6. " # ": The radiated frequency is out of the restricted band.

RF Mode	TX 802.11a	Channel	CH 52 : 5260 MHz
Frequency Range	1GHz ~ 40GHz	Detector Function	Peak (PK) Average (AV)

Antenna Polarity & Test Distance : Horizontal at 3 m

No	Frequency (MHz)	Emission Level (dBuV/m)	Limit (dBuV/m)	Margin (dB)	Antenna Height (m)	Table Angle (Degree)	Raw Value (dBuV)	Correction Factor (dB/m)
1	5150.00	50.9 PK	74.0	-23.1	2.09 H	114	48.6	2.3
2	5150.00	39.8 AV	54.0	-14.2	2.09 H	114	37.5	2.3
3	*5260.00	118.7 PK			2.09 H	114	116.7	2.0
4	*5260.00	108.6 AV			2.09 H	114	106.6	2.0
5	5350.00	51.0 PK	74.0	-23.0	2.09 H	114	49.1	1.9
6	5350.00	39.4 AV	54.0	-14.6	2.09 H	114	37.5	1.9
7	#10520.00	54.5 PK	68.2	-13.7	1.09 H	348	42.5	12.0
8	15780.00	58.4 PK	74.0	-15.6	1.50 H	275	46.9	11.5
9	15780.00	45.7 AV	54.0	-8.3	1.50 H	275	34.2	11.5

Antenna Polarity & Test Distance : Vertical at 3 m

No	Frequency (MHz)	Emission Level (dBuV/m)	Limit (dBuV/m)	Margin (dB)	Antenna Height (m)	Table Angle (Degree)	Raw Value (dBuV)	Correction Factor (dB/m)
1	5150.00	49.8 PK	74.0	-24.2	1.25 V	140	47.5	2.3
2	5150.00	38.2 AV	54.0	-15.8	1.25 V	140	35.9	2.3
3	*5260.00	112.1 PK			1.25 V	140	110.1	2.0
4	*5260.00	102.5 AV			1.25 V	140	100.5	2.0
5	5350.00	50.8 PK	74.0	-23.2	1.25 V	140	48.9	1.9
6	5350.00	38.9 AV	54.0	-15.1	1.25 V	140	37.0	1.9
7	#10520.00	54.5 PK	68.2	-13.7	2.19 V	188	42.5	12.0
8	15780.00	59.6 PK	74.0	-14.4	1.57 V	298	48.1	11.5
9	15780.00	47.7 AV	54.0	-6.3	1.57 V	298	36.2	11.5

Remarks:

1. Emission Level(dBuV/m) = Raw Value(dBuV) + Correction Factor(dB/m)
2. Correction Factor(dB/m) = Antenna Factor(dB/m) + Cable Factor(dB) – Pre-Amplifier Factor(dB)
3. Margin value = Emission Level – Limit value
4. The other emission levels were very low against the limit.
5. " * ": Fundamental frequency.
6. " # ": The radiated frequency is out of the restricted band.

RF Mode	TX 802.11a	Channel	CH 60 : 5300 MHz
Frequency Range	1GHz ~ 40GHz	Detector Function	Peak (PK) Average (AV)

Antenna Polarity & Test Distance : Horizontal at 3 m								
No	Frequency (MHz)	Emission Level (dBuV/m)	Limit (dBuV/m)	Margin (dB)	Antenna Height (m)	Table Angle (Degree)	Raw Value (dBuV)	Correction Factor (dB/m)
1	*5300.00	118.8 PK			2.15 H	110	117.1	1.7
2	*5300.00	108.6 AV			2.15 H	110	106.9	1.7
3	5350.00	63.7 PK	74.0	-10.3	2.15 H	110	61.8	1.9
4	5350.00	44.6 AV	54.0	-9.4	2.15 H	110	42.7	1.9
5	10600.00	54.7 PK	74.0	-19.3	1.11 H	352	42.8	11.9
6	10600.00	44.9 AV	54.0	-9.1	1.11 H	352	33.0	11.9
7	15900.00	58.7 PK	74.0	-15.3	1.51 H	285	47.4	11.3
8	15900.00	46.2 AV	54.0	-7.8	1.51 H	285	34.9	11.3

Antenna Polarity & Test Distance : Vertical at 3 m								
No	Frequency (MHz)	Emission Level (dBuV/m)	Limit (dBuV/m)	Margin (dB)	Antenna Height (m)	Table Angle (Degree)	Raw Value (dBuV)	Correction Factor (dB/m)
1	*5300.00	112.5 PK			1.26 V	109	110.8	1.7
2	*5300.00	102.7 AV			1.26 V	109	101.0	1.7
3	5350.00	60.4 PK	74.0	-13.6	1.26 V	109	58.5	1.9
4	5350.00	42.9 AV	54.0	-11.1	1.26 V	109	41.0	1.9
5	10600.00	55.0 PK	74.0	-19.0	2.08 V	168	43.1	11.9
6	10600.00	46.0 AV	54.0	-8.0	2.08 V	168	34.1	11.9
7	15900.00	60.2 PK	74.0	-13.8	1.56 V	279	48.9	11.3
8	15900.00	48.0 AV	54.0	-6.0	1.56 V	279	36.7	11.3

Remarks:

1. Emission Level(dBuV/m) = Raw Value(dBuV) + Correction Factor(dB/m)
2. Correction Factor(dB/m) = Antenna Factor(dB/m) + Cable Factor(dB) – Pre-Amplifier Factor(dB)
3. Margin value = Emission Level – Limit value
4. The other emission levels were very low against the limit.
5. " * ": Fundamental frequency.

RF Mode	TX 802.11a	Channel	CH 64 : 5320 MHz
Frequency Range	1GHz ~ 40GHz	Detector Function	Peak (PK) Average (AV)

Antenna Polarity & Test Distance : Horizontal at 3 m								
No	Frequency (MHz)	Emission Level (dBuV/m)	Limit (dBuV/m)	Margin (dB)	Antenna Height (m)	Table Angle (Degree)	Raw Value (dBuV)	Correction Factor (dB/m)
1	*5320.00	116.9 PK			2.14 H	106	115.1	1.8
2	*5320.00	107.2 AV			2.14 H	106	105.4	1.8
3	5350.00	68.2 PK	74.0	-5.8	2.14 H	106	66.3	1.9
4	5350.00	52.5 AV	54.0	-1.5	2.14 H	106	50.6	1.9
5	10640.00	54.0 PK	74.0	-20.0	1.05 H	360	42.2	11.8
6	10640.00	44.0 AV	54.0	-10.0	1.05 H	360	32.2	11.8
7	15960.00	59.2 PK	74.0	-14.8	1.43 H	295	47.6	11.6
8	15960.00	46.2 AV	54.0	-7.8	1.43 H	295	34.6	11.6

Antenna Polarity & Test Distance : Vertical at 3 m								
No	Frequency (MHz)	Emission Level (dBuV/m)	Limit (dBuV/m)	Margin (dB)	Antenna Height (m)	Table Angle (Degree)	Raw Value (dBuV)	Correction Factor (dB/m)
1	*5320.00	110.5 PK			1.53 V	121	108.7	1.8
2	*5320.00	100.8 AV			1.53 V	121	99.0	1.8
3	5350.00	64.8 PK	74.0	-9.2	1.53 V	121	62.9	1.9
4	5350.00	47.6 AV	54.0	-6.4	1.53 V	121	45.7	1.9
5	10640.00	55.2 PK	74.0	-18.8	2.11 V	184	43.4	11.8
6	10640.00	46.0 AV	54.0	-8.0	2.11 V	184	34.2	11.8
7	15960.00	60.2 PK	74.0	-13.8	1.53 V	289	48.6	11.6
8	15960.00	47.8 AV	54.0	-6.2	1.53 V	289	36.2	11.6

Remarks:

1. Emission Level(dBuV/m) = Raw Value(dBuV) + Correction Factor(dB/m)
2. Correction Factor(dB/m) = Antenna Factor(dB/m) + Cable Factor(dB) – Pre-Amplifier Factor(dB)
3. Margin value = Emission Level – Limit value
4. The other emission levels were very low against the limit.
5. " * ": Fundamental frequency.

RF Mode	TX 802.11a	Channel	CH 100 : 5500 MHz
Frequency Range	1GHz ~ 40GHz	Detector Function	Peak (PK) Average (AV)

Antenna Polarity & Test Distance : Horizontal at 3 m								
No	Frequency (MHz)	Emission Level (dBuV/m)	Limit (dBuV/m)	Margin (dB)	Antenna Height (m)	Table Angle (Degree)	Raw Value (dBuV)	Correction Factor (dB/m)
1	5460.00	58.4 PK	74.0	-15.6	2.12 H	129	56.3	2.1
2	5460.00	44.5 AV	54.0	-9.5	2.12 H	129	42.4	2.1
3	#5470.00	66.5 PK	68.2	-1.7	2.12 H	129	64.3	2.2
4	*5500.00	116.7 PK			2.12 H	129	114.6	2.1
5	*5500.00	106.4 AV			2.12 H	129	104.3	2.1
6	11000.00	54.0 PK	74.0	-20.0	1.08 H	342	41.6	12.4
7	11000.00	44.1 AV	54.0	-9.9	1.08 H	342	31.7	12.4
8	#16500.00	58.8 PK	68.2	-9.4	1.43 H	296	45.1	13.7

Antenna Polarity & Test Distance : Vertical at 3 m								
No	Frequency (MHz)	Emission Level (dBuV/m)	Limit (dBuV/m)	Margin (dB)	Antenna Height (m)	Table Angle (Degree)	Raw Value (dBuV)	Correction Factor (dB/m)
1	5453.60	51.2 PK	74.0	-22.8	1.42 V	118	49.1	2.1
2	5453.60	39.8 AV	54.0	-14.2	1.42 V	118	37.7	2.1
3	#5470.00	55.0 PK	68.2	-13.2	1.42 V	118	52.8	2.2
4	*5500.00	107.7 PK			1.42 V	118	105.6	2.1
5	*5500.00	98.6 AV			1.42 V	118	96.5	2.1
6	11000.00	55.1 PK	74.0	-18.9	2.12 V	165	42.7	12.4
7	11000.00	46.4 AV	54.0	-7.6	2.12 V	165	34.0	12.4
8	#16500.00	60.7 PK	68.2	-7.5	1.55 V	294	47.0	13.7

Remarks:

1. Emission Level(dBuV/m) = Raw Value(dBuV) + Correction Factor(dB/m)
2. Correction Factor(dB/m) = Antenna Factor(dB/m) + Cable Factor(dB) – Pre-Amplifier Factor(dB)
3. Margin value = Emission Level – Limit value
4. The other emission levels were very low against the limit.
5. " * ": Fundamental frequency.
6. " # ": The radiated frequency is out of the restricted band.

RF Mode	TX 802.11a	Channel	CH 116 : 5580 MHz
Frequency Range	1GHz ~ 40GHz	Detector Function	Peak (PK) Average (AV)

Antenna Polarity & Test Distance : Horizontal at 3 m								
No	Frequency (MHz)	Emission Level (dBuV/m)	Limit (dBuV/m)	Margin (dB)	Antenna Height (m)	Table Angle (Degree)	Raw Value (dBuV)	Correction Factor (dB/m)
1	5460.00	53.8 PK	74.0	-20.2	2.14 H	102	51.7	2.1
2	5460.00	42.3 AV	54.0	-11.7	2.14 H	102	40.2	2.1
3	#5470.00	55.6 PK	68.2	-12.6	2.14 H	102	53.4	2.2
4	*5580.00	119.0 PK			2.14 H	102	116.9	2.1
5	*5580.00	108.5 AV			2.14 H	102	106.4	2.1
6	11160.00	54.4 PK	74.0	-19.6	1.07 H	352	42.4	12.0
7	11160.00	44.5 AV	54.0	-9.5	1.07 H	352	32.5	12.0
8	#16740.00	58.8 PK	68.2	-9.4	1.45 H	281	43.5	15.3

Antenna Polarity & Test Distance : Vertical at 3 m								
No	Frequency (MHz)	Emission Level (dBuV/m)	Limit (dBuV/m)	Margin (dB)	Antenna Height (m)	Table Angle (Degree)	Raw Value (dBuV)	Correction Factor (dB/m)
1	5460.00	52.2 PK	74.0	-21.8	1.29 V	129	50.1	2.1
2	5460.00	41.6 AV	54.0	-12.4	1.29 V	129	39.5	2.1
3	#5470.00	54.2 PK	68.2	-14.0	1.29 V	129	52.0	2.2
4	*5580.00	112.1 PK			1.29 V	129	110.0	2.1
5	*5580.00	102.4 AV			1.29 V	129	100.3	2.1
6	11160.00	54.7 PK	74.0	-19.3	2.97 V	254	42.7	12.0
7	11160.00	45.6 AV	54.0	-8.4	2.97 V	254	33.6	12.0
8	#16740.00	59.5 PK	68.2	-8.7	1.35 V	283	44.2	15.3

Remarks:

1. Emission Level(dBuV/m) = Raw Value(dBuV) + Correction Factor(dB/m)
2. Correction Factor(dB/m) = Antenna Factor(dB/m) + Cable Factor(dB) – Pre-Amplifier Factor(dB)
3. Margin value = Emission Level – Limit value
4. The other emission levels were very low against the limit.
5. " * ": Fundamental frequency.
6. " # ": The radiated frequency is out of the restricted band.

RF Mode	TX 802.11a	Channel	CH 140 : 5700 MHz
Frequency Range	1GHz ~ 40GHz	Detector Function	Peak (PK) Average (AV)

Antenna Polarity & Test Distance : Horizontal at 3 m

No	Frequency (MHz)	Emission Level (dBuV/m)	Limit (dBuV/m)	Margin (dB)	Antenna Height (m)	Table Angle (Degree)	Raw Value (dBuV)	Correction Factor (dB/m)
1	*5700.00	111.1 PK			1.98 H	126	108.8	2.3
2	*5700.00	100.7 AV			1.98 H	126	98.4	2.3
3	#5725.00	66.4 PK	68.2	-1.8	1.98 H	126	64.0	2.4
4	11400.00	54.2 PK	74.0	-19.8	1.09 H	336	41.7	12.5
5	11400.00	44.4 AV	54.0	-9.6	1.09 H	336	31.9	12.5
6	#17100.00	58.6 PK	68.2	-9.6	1.46 H	277	41.8	16.8

Antenna Polarity & Test Distance : Vertical at 3 m

No	Frequency (MHz)	Emission Level (dBuV/m)	Limit (dBuV/m)	Margin (dB)	Antenna Height (m)	Table Angle (Degree)	Raw Value (dBuV)	Correction Factor (dB/m)
1	*5700.00	107.3 PK			1.40 V	132	105.0	2.3
2	*5700.00	98.4 AV			1.40 V	132	96.1	2.3
3	#5725.00	56.9 PK	68.2	-11.3	1.40 V	132	54.5	2.4
4	11400.00	55.0 PK	74.0	-19.0	2.96 V	249	42.5	12.5
5	11400.00	46.1 AV	54.0	-7.9	2.96 V	249	33.6	12.5
6	#17100.00	59.3 PK	68.2	-8.9	1.32 V	292	42.5	16.8

Remarks:

1. Emission Level(dBuV/m) = Raw Value(dBuV) + Correction Factor(dB/m)
2. Correction Factor(dB/m) = Antenna Factor(dB/m) + Cable Factor(dB) – Pre-Amplifier Factor(dB)
3. Margin value = Emission Level – Limit value
4. The other emission levels were very low against the limit.
5. " * ": Fundamental frequency.
6. " # ": The radiated frequency is out of the restricted band.

RF Mode	TX 802.11a	Channel	CH 144 : 5720 MHz
Frequency Range	1GHz ~ 40GHz	Detector Function	Peak (PK) Average (AV)

Antenna Polarity & Test Distance : Horizontal at 3 m								
No	Frequency (MHz)	Emission Level (dBuV/m)	Limit (dBuV/m)	Margin (dB)	Antenna Height (m)	Table Angle (Degree)	Raw Value (dBuV)	Correction Factor (dB/m)
1	5460.00	51.5 PK	74.0	-22.5	2.17 H	117	49.4	2.1
2	5460.00	39.4 AV	54.0	-14.6	2.17 H	117	37.3	2.1
3	#5470.00	52.9 PK	68.2	-15.3	2.17 H	117	50.7	2.2
4	*5720.00	119.3 PK			2.17 H	117	116.9	2.4
5	*5720.00	108.6 AV			2.17 H	117	106.2	2.4
6	#5850.00	54.8 PK	68.2	-13.4	2.17 H	117	52.1	2.7
7	11440.00	54.6 PK	74.0	-19.4	1.02 H	340	42.2	12.4
8	11440.00	44.5 AV	54.0	-9.5	1.02 H	340	32.1	12.4
9	#17160.00	58.7 PK	68.2	-9.5	1.41 H	294	42.1	16.6

Antenna Polarity & Test Distance : Vertical at 3 m								
No	Frequency (MHz)	Emission Level (dBuV/m)	Limit (dBuV/m)	Margin (dB)	Antenna Height (m)	Table Angle (Degree)	Raw Value (dBuV)	Correction Factor (dB/m)
1	5460.00	50.7 PK	74.0	-23.3	1.45 V	139	48.6	2.1
2	5460.00	38.3 AV	54.0	-15.7	1.45 V	139	36.2	2.1
3	#5470.00	51.5 PK	68.2	-16.7	1.45 V	139	49.3	2.2
4	*5720.00	112.3 PK			1.45 V	139	109.9	2.4
5	*5720.00	102.5 AV			1.45 V	139	100.1	2.4
6	#5850.00	53.4 PK	68.2	-14.8	1.45 V	139	50.7	2.7
7	11440.00	54.8 PK	74.0	-19.2	2.99 V	252	42.4	12.4
8	11440.00	45.9 AV	54.0	-8.1	2.99 V	252	33.5	12.4
9	#17160.00	59.8 PK	68.2	-8.4	1.40 V	280	43.2	16.6

Remarks:

1. Emission Level(dBuV/m) = Raw Value(dBuV) + Correction Factor(dB/m)
2. Correction Factor(dB/m) = Antenna Factor(dB/m) + Cable Factor(dB) – Pre-Amplifier Factor(dB)
3. Margin value = Emission Level – Limit value
4. The other emission levels were very low against the limit.
5. " * ": Fundamental frequency.
6. " # ": The radiated frequency is out of the restricted band.

RF Mode	TX 802.11a	Channel	CH 149 : 5745 MHz
Frequency Range	1GHz ~ 40GHz	Detector Function	Peak (PK) Average (AV)

Antenna Polarity & Test Distance : Horizontal at 3 m

No	Frequency (MHz)	Emission Level (dBuV/m)	Limit (dBuV/m)	Margin (dB)	Antenna Height (m)	Table Angle (Degree)	Raw Value (dBuV)	Correction Factor (dB/m)
1	#5637.45	53.4 PK	68.2	-14.8	1.95 H	107	51.1	2.3
2	*5745.00	117.3 PK			1.95 H	107	114.9	2.4
3	*5745.00	107.7 AV			1.95 H	107	105.3	2.4
4	#5931.54	48.9 PK	68.2	-19.3	1.95 H	107	46.0	2.9
5	11490.00	54.3 PK	74.0	-19.7	1.04 H	345	41.7	12.6
6	11490.00	44.5 AV	54.0	-9.5	1.04 H	345	31.9	12.6
7	#17235.00	58.9 PK	68.2	-9.3	1.41 H	279	42.1	16.8

Antenna Polarity & Test Distance : Vertical at 3 m

No	Frequency (MHz)	Emission Level (dBuV/m)	Limit (dBuV/m)	Margin (dB)	Antenna Height (m)	Table Angle (Degree)	Raw Value (dBuV)	Correction Factor (dB/m)
1	#5639.83	52.1 PK	68.2	-16.1	1.35 V	120	49.8	2.3
2	*5745.00	112.2 PK			1.35 V	120	109.8	2.4
3	*5745.00	100.6 AV			1.35 V	120	98.2	2.4
4	#5983.90	51.0 PK	68.2	-17.2	1.35 V	120	48.1	2.9
5	11490.00	54.4 PK	74.0	-19.6	2.97 V	267	41.8	12.6
6	11490.00	45.5 AV	54.0	-8.5	2.97 V	267	32.9	12.6
7	#17235.00	60.6 PK	68.2	-7.6	1.37 V	294	43.8	16.8

Remarks:

1. Emission Level(dBuV/m) = Raw Value(dBuV) + Correction Factor(dB/m)
2. Correction Factor(dB/m) = Antenna Factor(dB/m) + Cable Factor(dB) – Pre-Amplifier Factor(dB)
3. Margin value = Emission Level – Limit value
4. The other emission levels were very low against the limit.
5. " * ": Fundamental frequency.
6. " # ": The radiated frequency is out of the restricted band.

RF Mode	TX 802.11a	Channel	CH 157 : 5785 MHz
Frequency Range	1GHz ~ 40GHz	Detector Function	Peak (PK) Average (AV)

Antenna Polarity & Test Distance : Horizontal at 3 m								
No	Frequency (MHz)	Emission Level (dBuV/m)	Limit (dBuV/m)	Margin (dB)	Antenna Height (m)	Table Angle (Degree)	Raw Value (dBuV)	Correction Factor (dB/m)
1	#5570.00	52.8 PK	68.2	-15.4	2.05 H	110	50.7	2.1
2	*5785.00	117.2 PK			2.05 H	110	114.6	2.6
3	*5785.00	107.6 AV			2.05 H	110	105.0	2.6
4	#5935.27	49.2 PK	68.2	-19.0	2.05 H	110	46.3	2.9
5	11570.00	54.2 PK	74.0	-19.8	3.62 H	302	41.6	12.6
6	11570.00	44.1 AV	54.0	-9.9	3.62 H	302	31.5	12.6
7	#17355.00	59.2 PK	68.2	-9.0	1.51 H	282	41.5	17.7

Antenna Polarity & Test Distance : Vertical at 3 m								
No	Frequency (MHz)	Emission Level (dBuV/m)	Limit (dBuV/m)	Margin (dB)	Antenna Height (m)	Table Angle (Degree)	Raw Value (dBuV)	Correction Factor (dB/m)
1	#5640.52	50.8 PK	68.2	-17.4	1.42 V	129	48.5	2.3
2	*5785.00	112.0 PK			1.42 V	129	109.4	2.6
3	*5785.00	100.3 AV			1.42 V	129	97.7	2.6
4	#5977.89	50.9 PK	68.2	-17.3	1.42 V	129	48.0	2.9
5	11570.00	54.8 PK	74.0	-19.2	2.51 V	320	42.2	12.6
6	11570.00	45.6 AV	54.0	-8.4	2.51 V	320	33.0	12.6
7	#17355.00	59.6 PK	68.2	-8.6	2.50 V	354	41.9	17.7

Remarks:

1. Emission Level(dBuV/m) = Raw Value(dBuV) + Correction Factor(dB/m)
2. Correction Factor(dB/m) = Antenna Factor(dB/m) + Cable Factor(dB) – Pre-Amplifier Factor(dB)
3. Margin value = Emission Level – Limit value
4. The other emission levels were very low against the limit.
5. " * ": Fundamental frequency.
6. " # ": The radiated frequency is out of the restricted band.

RF Mode	TX 802.11a	Channel	CH 165 : 5825 MHz
Frequency Range	1GHz ~ 40GHz	Detector Function	Peak (PK) Average (AV)

Antenna Polarity & Test Distance : Horizontal at 3 m

No	Frequency (MHz)	Emission Level (dBuV/m)	Limit (dBuV/m)	Margin (dB)	Antenna Height (m)	Table Angle (Degree)	Raw Value (dBuV)	Correction Factor (dB/m)
1	#5592.20	52.0 PK	68.2	-16.2	1.98 H	108	49.9	2.1
2	*5825.00	117.0 PK			1.98 H	108	114.4	2.6
3	*5825.00	107.2 AV			1.98 H	108	104.6	2.6
4	#6023.99	49.8 PK	68.2	-18.4	1.98 H	108	46.8	3.0
5	11650.00	54.0 PK	74.0	-20.0	1.05 H	336	41.8	12.2
6	11650.00	44.1 AV	54.0	-9.9	1.05 H	336	31.9	12.2
7	#17475.00	58.2 PK	68.2	-10.0	1.49 H	267	39.5	18.7

Antenna Polarity & Test Distance : Vertical at 3 m

No	Frequency (MHz)	Emission Level (dBuV/m)	Limit (dBuV/m)	Margin (dB)	Antenna Height (m)	Table Angle (Degree)	Raw Value (dBuV)	Correction Factor (dB/m)
1	#5636.88	50.7 PK	68.2	-17.5	1.46 V	128	48.4	2.3
2	*5825.00	112.6 PK			1.46 V	128	110.0	2.6
3	*5825.00	100.6 AV			1.46 V	128	98.0	2.6
4	#5930.05	50.2 PK	68.2	-18.0	1.46 V	128	47.3	2.9
5	11650.00	55.0 PK	74.0	-19.0	2.53 V	329	42.8	12.2
6	11650.00	45.9 AV	54.0	-8.1	2.53 V	329	33.7	12.2
7	#17475.00	59.8 PK	68.2	-8.4	2.55 V	360	41.1	18.7

Remarks:

1. Emission Level(dBuV/m) = Raw Value(dBuV) + Correction Factor(dB/m)
2. Correction Factor(dB/m) = Antenna Factor(dB/m) + Cable Factor(dB) – Pre-Amplifier Factor(dB)
3. Margin value = Emission Level – Limit value
4. The other emission levels were very low against the limit.
5. " * ": Fundamental frequency.
6. " # ": The radiated frequency is out of the restricted band.

RF Mode	TX 802.11ax (HE20)	Channel	CH 36 : 5180 MHz
Frequency Range	1GHz ~ 40GHz	Detector Function	Peak (PK) Average (AV)

Antenna Polarity & Test Distance : Horizontal at 3 m								
No	Frequency (MHz)	Emission Level (dBuV/m)	Limit (dBuV/m)	Margin (dB)	Antenna Height (m)	Table Angle (Degree)	Raw Value (dBuV)	Correction Factor (dB/m)
1	5150.00	68.6 PK	74.0	-5.4	2.15 H	123	66.3	2.3
2	5150.00	52.5 AV	54.0	-1.5	2.15 H	123	50.2	2.3
3	*5180.00	118.3 PK			2.15 H	123	116.1	2.2
4	*5180.00	107.6 AV			2.15 H	123	105.4	2.2
5	#10360.00	54.7 PK	68.2	-13.5	1.02 H	341	42.9	11.8
6	15540.00	59.3 PK	74.0	-14.7	1.47 H	270	47.5	11.8
7	15540.00	46.5 AV	54.0	-7.5	1.47 H	270	34.7	11.8

Antenna Polarity & Test Distance : Vertical at 3 m								
No	Frequency (MHz)	Emission Level (dBuV/m)	Limit (dBuV/m)	Margin (dB)	Antenna Height (m)	Table Angle (Degree)	Raw Value (dBuV)	Correction Factor (dB/m)
1	5150.00	57.8 PK	74.0	-16.2	1.30 V	135	55.5	2.3
2	5150.00	47.8 AV	54.0	-6.2	1.30 V	135	45.5	2.3
3	*5180.00	112.3 PK			1.30 V	135	110.1	2.2
4	*5180.00	100.9 AV			1.30 V	135	98.7	2.2
5	#10360.00	55.1 PK	68.2	-13.1	2.19 V	174	43.3	11.8
6	15540.00	59.5 PK	74.0	-14.5	1.60 V	252	47.7	11.8
7	15540.00	47.6 AV	54.0	-6.4	1.60 V	252	35.8	11.8

Remarks:

1. Emission Level(dBuV/m) = Raw Value(dBuV) + Correction Factor(dB/m)
2. Correction Factor(dB/m) = Antenna Factor(dB/m) + Cable Factor(dB) – Pre-Amplifier Factor(dB)
3. Margin value = Emission Level – Limit value
4. The other emission levels were very low against the limit.
5. " * ": Fundamental frequency.
6. " # ": The radiated frequency is out of the restricted band.

RF Mode	TX 802.11ax (HE20)	Channel	CH 40 : 5200 MHz
Frequency Range	1GHz ~ 40GHz	Detector Function	Peak (PK) Average (AV)

Antenna Polarity & Test Distance : Horizontal at 3 m

No	Frequency (MHz)	Emission Level (dBuV/m)	Limit (dBuV/m)	Margin (dB)	Antenna Height (m)	Table Angle (Degree)	Raw Value (dBuV)	Correction Factor (dB/m)
1	5150.00	55.9 PK	74.0	-18.1	2.19 H	128	53.6	2.3
2	5150.00	44.1 AV	54.0	-9.9	2.19 H	128	41.8	2.3
3	*5200.00	118.7 PK			2.19 H	128	116.6	2.1
4	*5200.00	108.1 AV			2.19 H	128	106.0	2.1
5	#10400.00	54.4 PK	68.2	-13.8	1.13 H	337	42.4	12.0
6	15600.00	59.0 PK	74.0	-15.0	1.49 H	267	47.5	11.5
7	15600.00	46.5 AV	54.0	-7.5	1.49 H	267	35.0	11.5

Antenna Polarity & Test Distance : Vertical at 3 m

No	Frequency (MHz)	Emission Level (dBuV/m)	Limit (dBuV/m)	Margin (dB)	Antenna Height (m)	Table Angle (Degree)	Raw Value (dBuV)	Correction Factor (dB/m)
1	5150.00	54.8 PK	74.0	-19.2	1.32 V	130	52.5	2.3
2	5150.00	43.1 AV	54.0	-10.9	1.32 V	130	40.8	2.3
3	*5200.00	113.6 PK			1.32 V	130	111.5	2.1
4	*5200.00	102.6 AV			1.32 V	130	100.5	2.1
5	#10400.00	54.5 PK	68.2	-13.7	2.25 V	169	42.5	12.0
6	15600.00	60.2 PK	74.0	-13.8	1.68 V	254	48.7	11.5
7	15600.00	48.1 AV	54.0	-5.9	1.68 V	254	36.6	11.5

Remarks:

1. Emission Level(dBuV/m) = Raw Value(dBuV) + Correction Factor(dB/m)
2. Correction Factor(dB/m) = Antenna Factor(dB/m) + Cable Factor(dB) – Pre-Amplifier Factor(dB)
3. Margin value = Emission Level – Limit value
4. The other emission levels were very low against the limit.
5. " * ": Fundamental frequency.
6. " # ": The radiated frequency is out of the restricted band.

RF Mode	TX 802.11ax (HE20)	Channel	CH 48 : 5240 MHz
Frequency Range	1GHz ~ 40GHz	Detector Function	Peak (PK) Average (AV)

Antenna Polarity & Test Distance : Horizontal at 3 m

No	Frequency (MHz)	Emission Level (dBuV/m)	Limit (dBuV/m)	Margin (dB)	Antenna Height (m)	Table Angle (Degree)	Raw Value (dBuV)	Correction Factor (dB/m)
1	5150.00	51.2 PK	74.0	-22.8	2.12 H	138	48.9	2.3
2	5150.00	39.8 AV	54.0	-14.2	2.12 H	138	37.5	2.3
3	*5240.00	118.3 PK			2.12 H	138	116.3	2.0
4	*5240.00	107.9 AV			2.12 H	138	105.9	2.0
5	5350.00	51.6 PK	74.0	-22.4	2.12 H	138	49.7	1.9
6	5350.00	39.2 AV	54.0	-14.8	2.12 H	138	37.3	1.9
7	#10480.00	53.8 PK	68.2	-14.4	1.10 H	360	41.9	11.9
8	15720.00	59.0 PK	74.0	-15.0	1.45 H	272	47.2	11.8
9	15720.00	46.1 AV	54.0	-7.9	1.45 H	272	34.3	11.8

Antenna Polarity & Test Distance : Vertical at 3 m

No	Frequency (MHz)	Emission Level (dBuV/m)	Limit (dBuV/m)	Margin (dB)	Antenna Height (m)	Table Angle (Degree)	Raw Value (dBuV)	Correction Factor (dB/m)
1	5150.00	50.6 PK	74.0	-23.4	1.30 V	142	48.3	2.3
2	5150.00	38.2 AV	54.0	-15.8	1.30 V	142	35.9	2.3
3	*5240.00	113.9 PK			1.30 V	142	111.9	2.0
4	*5240.00	102.6 AV			1.30 V	142	100.6	2.0
5	5350.00	50.9 PK	74.0	-23.1	1.30 V	142	49.0	1.9
6	5350.00	38.8 AV	54.0	-15.2	1.30 V	142	36.9	1.9
7	#10480.00	55.0 PK	68.2	-13.2	2.27 V	176	43.1	11.9
8	15720.00	59.4 PK	74.0	-14.6	1.66 V	258	47.6	11.8
9	15720.00	47.5 AV	54.0	-6.5	1.66 V	258	35.7	11.8

Remarks:

1. Emission Level(dBuV/m) = Raw Value(dBuV) + Correction Factor(dB/m)
2. Correction Factor(dB/m) = Antenna Factor(dB/m) + Cable Factor(dB) – Pre-Amplifier Factor(dB)
3. Margin value = Emission Level – Limit value
4. The other emission levels were very low against the limit.
5. " * ": Fundamental frequency.
6. " # ": The radiated frequency is out of the restricted band.

RF Mode	TX 802.11ax (HE20)	Channel	CH 52 : 5260 MHz
Frequency Range	1GHz ~ 40GHz	Detector Function	Peak (PK) Average (AV)

Antenna Polarity & Test Distance : Horizontal at 3 m

No	Frequency (MHz)	Emission Level (dBuV/m)	Limit (dBuV/m)	Margin (dB)	Antenna Height (m)	Table Angle (Degree)	Raw Value (dBuV)	Correction Factor (dB/m)
1	5150.00	52.0 PK	74.0	-22.0	2.08 H	140	49.7	2.3
2	5150.00	39.9 AV	54.0	-14.1	2.08 H	140	37.6	2.3
3	*5260.00	118.5 PK			2.08 H	140	116.5	2.0
4	*5260.00	108.2 AV			2.08 H	140	106.2	2.0
5	5350.00	51.8 PK	74.0	-22.2	2.08 H	140	49.9	1.9
6	5350.00	39.5 AV	54.0	-14.5	2.08 H	140	37.6	1.9
7	#10520.00	54.3 PK	68.2	-13.9	1.03 H	356	42.3	12.0
8	15780.00	58.4 PK	74.0	-15.6	1.51 H	296	46.9	11.5
9	15780.00	45.8 AV	54.0	-8.2	1.51 H	296	34.3	11.5

Antenna Polarity & Test Distance : Vertical at 3 m

No	Frequency (MHz)	Emission Level (dBuV/m)	Limit (dBuV/m)	Margin (dB)	Antenna Height (m)	Table Angle (Degree)	Raw Value (dBuV)	Correction Factor (dB/m)
1	5150.00	51.4 PK	74.0	-22.6	1.31 V	127	49.1	2.3
2	5150.00	38.2 AV	54.0	-15.8	1.31 V	127	35.9	2.3
3	*5260.00	113.6 PK			1.31 V	127	111.6	2.0
4	*5260.00	102.7 AV			1.31 V	127	100.7	2.0
5	5350.00	50.8 PK	74.0	-23.2	1.31 V	127	48.9	1.9
6	5350.00	37.9 AV	54.0	-16.1	1.31 V	127	36.0	1.9
7	#10520.00	55.4 PK	68.2	-12.8	2.28 V	179	43.4	12.0
8	15780.00	59.8 PK	74.0	-14.2	1.70 V	282	48.3	11.5
9	15780.00	47.7 AV	54.0	-6.3	1.70 V	282	36.2	11.5

Remarks:

1. Emission Level(dBuV/m) = Raw Value(dBuV) + Correction Factor(dB/m)
2. Correction Factor(dB/m) = Antenna Factor(dB/m) + Cable Factor(dB) – Pre-Amplifier Factor(dB)
3. Margin value = Emission Level – Limit value
4. The other emission levels were very low against the limit.
5. " * ": Fundamental frequency.
6. " # ": The radiated frequency is out of the restricted band.

RF Mode	TX 802.11ax (HE20)	Channel	CH 60 : 5300 MHz
Frequency Range	1GHz ~ 40GHz	Detector Function	Peak (PK) Average (AV)

Antenna Polarity & Test Distance : Horizontal at 3 m								
No	Frequency (MHz)	Emission Level (dBuV/m)	Limit (dBuV/m)	Margin (dB)	Antenna Height (m)	Table Angle (Degree)	Raw Value (dBuV)	Correction Factor (dB/m)
1	*5300.00	118.6 PK			2.11 H	128	116.9	1.7
2	*5300.00	108.5 AV			2.11 H	128	106.8	1.7
3	5350.00	60.2 PK	74.0	-13.8	2.11 H	128	58.3	1.9
4	5350.00	44.9 AV	54.0	-9.1	2.11 H	128	43.0	1.9
5	10600.00	54.9 PK	74.0	-19.1	1.05 H	360	43.0	11.9
6	10600.00	44.9 AV	54.0	-9.1	1.05 H	360	33.0	11.9
7	15900.00	58.7 PK	74.0	-15.3	1.43 H	278	47.4	11.3
8	15900.00	46.2 AV	54.0	-7.8	1.43 H	278	34.9	11.3

Antenna Polarity & Test Distance : Vertical at 3 m								
No	Frequency (MHz)	Emission Level (dBuV/m)	Limit (dBuV/m)	Margin (dB)	Antenna Height (m)	Table Angle (Degree)	Raw Value (dBuV)	Correction Factor (dB/m)
1	*5300.00	113.8 PK			1.35 V	144	112.1	1.7
2	*5300.00	102.8 AV			1.35 V	144	101.1	1.7
3	5350.00	58.3 PK	74.0	-15.7	1.35 V	144	56.4	1.9
4	5350.00	42.9 AV	54.0	-11.1	1.35 V	144	41.0	1.9
5	10600.00	55.2 PK	74.0	-18.8	2.22 V	192	43.3	11.9
6	10600.00	46.4 AV	54.0	-7.6	2.22 V	192	34.5	11.9
7	15900.00	59.8 PK	74.0	-14.2	1.68 V	257	48.5	11.3
8	15900.00	47.7 AV	54.0	-6.3	1.68 V	257	36.4	11.3

Remarks:

1. Emission Level(dBuV/m) = Raw Value(dBuV) + Correction Factor(dB/m)
2. Correction Factor(dB/m) = Antenna Factor(dB/m) + Cable Factor(dB) – Pre-Amplifier Factor(dB)
3. Margin value = Emission Level – Limit value
4. The other emission levels were very low against the limit.
5. " * ": Fundamental frequency.

RF Mode	TX 802.11ax (HE20)	Channel	CH 64 : 5320 MHz
Frequency Range	1GHz ~ 40GHz	Detector Function	Peak (PK) Average (AV)

Antenna Polarity & Test Distance : Horizontal at 3 m								
No	Frequency (MHz)	Emission Level (dBuV/m)	Limit (dBuV/m)	Margin (dB)	Antenna Height (m)	Table Angle (Degree)	Raw Value (dBuV)	Correction Factor (dB/m)
1	*5320.00	118.1 PK			2.10 H	108	116.3	1.8
2	*5320.00	106.4 AV			2.10 H	108	104.6	1.8
3	5350.00	66.7 PK	74.0	-7.3	2.10 H	108	64.8	1.9
4	5350.00	52.5 AV	54.0	-1.5	2.10 H	108	50.6	1.9
5	10640.00	54.6 PK	74.0	-19.4	1.03 H	344	42.8	11.8
6	10640.00	44.7 AV	54.0	-9.3	1.03 H	344	32.9	11.8
7	15960.00	58.2 PK	74.0	-15.8	1.42 H	288	46.6	11.6
8	15960.00	45.7 AV	54.0	-8.3	1.42 H	288	34.1	11.6

Antenna Polarity & Test Distance : Vertical at 3 m								
No	Frequency (MHz)	Emission Level (dBuV/m)	Limit (dBuV/m)	Margin (dB)	Antenna Height (m)	Table Angle (Degree)	Raw Value (dBuV)	Correction Factor (dB/m)
1	*5320.00	109.6 PK			1.22 V	118	107.8	1.8
2	*5320.00	98.9 AV			1.22 V	118	97.1	1.8
3	5350.00	61.0 PK	74.0	-13.0	1.22 V	118	59.1	1.9
4	5350.00	48.0 AV	54.0	-6.0	1.22 V	118	46.1	1.9
5	10640.00	55.6 PK	74.0	-18.4	2.19 V	191	43.8	11.8
6	10640.00	46.4 AV	54.0	-7.6	2.19 V	191	34.6	11.8
7	15960.00	59.5 PK	74.0	-14.5	1.63 V	282	47.9	11.6
8	15960.00	47.7 AV	54.0	-6.3	1.63 V	282	36.1	11.6

Remarks:

1. Emission Level(dBuV/m) = Raw Value(dBuV) + Correction Factor(dB/m)
2. Correction Factor(dB/m) = Antenna Factor(dB/m) + Cable Factor(dB) – Pre-Amplifier Factor(dB)
3. Margin value = Emission Level – Limit value
4. The other emission levels were very low against the limit.
5. " * ": Fundamental frequency.

RF Mode	TX 802.11ax (HE20)	Channel	CH 100 : 5500 MHz
Frequency Range	1GHz ~ 40GHz	Detector Function	Peak (PK) Average (AV)

Antenna Polarity & Test Distance : Horizontal at 3 m								
No	Frequency (MHz)	Emission Level (dBuV/m)	Limit (dBuV/m)	Margin (dB)	Antenna Height (m)	Table Angle (Degree)	Raw Value (dBuV)	Correction Factor (dB/m)
1	5460.00	59.5 PK	74.0	-14.5	2.17 H	126	57.4	2.1
2	5460.00	45.9 AV	54.0	-8.1	2.17 H	126	43.8	2.1
3	#5470.00	66.7 PK	68.2	-1.5	2.17 H	126	64.5	2.2
4	*5500.00	117.8 PK			2.17 H	126	115.7	2.1
5	*5500.00	106.2 AV			2.17 H	126	104.1	2.1
6	11000.00	54.5 PK	74.0	-19.5	1.11 H	360	42.1	12.4
7	11000.00	44.6 AV	54.0	-9.4	1.11 H	360	32.2	12.4
8	#16500.00	58.8 PK	68.2	-9.4	1.43 H	292	45.1	13.7

Antenna Polarity & Test Distance : Vertical at 3 m								
No	Frequency (MHz)	Emission Level (dBuV/m)	Limit (dBuV/m)	Margin (dB)	Antenna Height (m)	Table Angle (Degree)	Raw Value (dBuV)	Correction Factor (dB/m)
1	5460.00	51.5 PK	74.0	-22.5	1.28 V	110	49.4	2.1
2	5460.00	39.5 AV	54.0	-14.5	1.28 V	110	37.4	2.1
3	#5470.00	55.9 PK	68.2	-12.3	1.28 V	110	53.7	2.2
4	*5500.00	108.7 PK			1.28 V	110	106.6	2.1
5	*5500.00	98.9 AV			1.28 V	110	96.8	2.1
6	11000.00	55.2 PK	74.0	-18.8	2.24 V	172	42.8	12.4
7	11000.00	46.1 AV	54.0	-7.9	2.24 V	172	33.7	12.4
8	#16500.00	59.3 PK	68.2	-8.9	1.69 V	260	45.6	13.7

Remarks:

1. Emission Level(dBuV/m) = Raw Value(dBuV) + Correction Factor(dB/m)
2. Correction Factor(dB/m) = Antenna Factor(dB/m) + Cable Factor(dB) – Pre-Amplifier Factor(dB)
3. Margin value = Emission Level – Limit value
4. The other emission levels were very low against the limit.
5. " * ": Fundamental frequency.
6. " # ": The radiated frequency is out of the restricted band.

RF Mode	TX 802.11ax (HE20)	Channel	CH 116 : 5580 MHz
Frequency Range	1GHz ~ 40GHz	Detector Function	Peak (PK) Average (AV)

Antenna Polarity & Test Distance : Horizontal at 3 m

No	Frequency (MHz)	Emission Level (dBuV/m)	Limit (dBuV/m)	Margin (dB)	Antenna Height (m)	Table Angle (Degree)	Raw Value (dBuV)	Correction Factor (dB/m)
1	5460.00	53.3 PK	74.0	-20.7	2.05 H	129	51.2	2.1
2	5460.00	42.3 AV	54.0	-11.7	2.05 H	129	40.2	2.1
3	#5470.00	55.9 PK	68.2	-12.3	2.05 H	129	53.7	2.2
4	*5580.00	118.5 PK			2.05 H	129	116.4	2.1
5	*5580.00	108.5 AV			2.05 H	129	106.4	2.1
6	11160.00	54.5 PK	74.0	-19.5	1.09 H	341	42.5	12.0
7	11160.00	44.8 AV	54.0	-9.2	1.09 H	341	32.8	12.0
8	#16740.00	59.2 PK	68.2	-9.0	1.39 H	282	43.9	15.3

Antenna Polarity & Test Distance : Vertical at 3 m

No	Frequency (MHz)	Emission Level (dBuV/m)	Limit (dBuV/m)	Margin (dB)	Antenna Height (m)	Table Angle (Degree)	Raw Value (dBuV)	Correction Factor (dB/m)
1	5460.00	52.1 PK	74.0	-21.9	1.37 V	133	50.0	2.1
2	5460.00	41.8 AV	54.0	-12.2	1.37 V	133	39.7	2.1
3	#5470.00	54.5 PK	68.2	-13.7	1.37 V	133	52.3	2.2
4	*5580.00	113.9 PK			1.37 V	133	111.8	2.1
5	*5580.00	102.7 AV			1.37 V	133	100.6	2.1
6	11160.00	54.8 PK	74.0	-19.2	2.20 V	185	42.8	12.0
7	11160.00	45.7 AV	54.0	-8.3	2.20 V	185	33.7	12.0
8	#16740.00	60.2 PK	68.2	-8.0	1.67 V	271	44.9	15.3

Remarks:

1. Emission Level(dBuV/m) = Raw Value(dBuV) + Correction Factor(dB/m)
2. Correction Factor(dB/m) = Antenna Factor(dB/m) + Cable Factor(dB) – Pre-Amplifier Factor(dB)
3. Margin value = Emission Level – Limit value
4. The other emission levels were very low against the limit.
5. " * ": Fundamental frequency.
6. " # ": The radiated frequency is out of the restricted band.

RF Mode	TX 802.11ax (HE20)	Channel	CH 140 : 5700 MHz
Frequency Range	1GHz ~ 40GHz	Detector Function	Peak (PK) Average (AV)

Antenna Polarity & Test Distance : Horizontal at 3 m

No	Frequency (MHz)	Emission Level (dBuV/m)	Limit (dBuV/m)	Margin (dB)	Antenna Height (m)	Table Angle (Degree)	Raw Value (dBuV)	Correction Factor (dB/m)
1	*5700.00	118.1 PK			1.98 H	116	115.8	2.3
2	*5700.00	107.5 AV			1.98 H	116	105.2	2.3
3	#5725.25	66.4 PK	68.2	-1.8	1.98 H	116	64.0	2.4
4	11400.00	54.0 PK	74.0	-20.0	1.06 H	344	41.5	12.5
5	11400.00	44.2 AV	54.0	-9.8	1.06 H	344	31.7	12.5
6	#17100.00	58.6 PK	68.2	-9.6	1.47 H	286	41.8	16.8

Antenna Polarity & Test Distance : Vertical at 3 m

No	Frequency (MHz)	Emission Level (dBuV/m)	Limit (dBuV/m)	Margin (dB)	Antenna Height (m)	Table Angle (Degree)	Raw Value (dBuV)	Correction Factor (dB/m)
1	*5700.00	108.5 PK			1.23 V	102	106.2	2.3
2	*5700.00	98.6 AV			1.23 V	102	96.3	2.3
3	#5725.00	57.6 PK	68.2	-10.6	1.23 V	102	55.2	2.4
4	11400.00	55.5 PK	74.0	-18.5	2.24 V	191	43.0	12.5
5	11400.00	46.5 AV	54.0	-7.5	2.24 V	191	34.0	12.5
6	#17100.00	59.1 PK	68.2	-9.1	1.59 V	275	42.3	16.8

Remarks:

1. Emission Level(dBuV/m) = Raw Value(dBuV) + Correction Factor(dB/m)
2. Correction Factor(dB/m) = Antenna Factor(dB/m) + Cable Factor(dB) – Pre-Amplifier Factor(dB)
3. Margin value = Emission Level – Limit value
4. The other emission levels were very low against the limit.
5. " * " : Fundamental frequency.
6. " # " : The radiated frequency is out of the restricted band.

RF Mode	TX 802.11ax (HE20)	Channel	CH 144 : 5720 MHz
Frequency Range	1GHz ~ 40GHz	Detector Function	Peak (PK) Average (AV)

Antenna Polarity & Test Distance : Horizontal at 3 m								
No	Frequency (MHz)	Emission Level (dBuV/m)	Limit (dBuV/m)	Margin (dB)	Antenna Height (m)	Table Angle (Degree)	Raw Value (dBuV)	Correction Factor (dB/m)
1	5460.00	51.5 PK	74.0	-22.5	2.09 H	130	49.4	2.1
2	5460.00	39.7 AV	54.0	-14.3	2.09 H	130	37.6	2.1
3	#5470.00	52.0 PK	68.2	-16.2	2.09 H	130	49.8	2.2
4	*5720.00	119.1 PK			2.09 H	130	116.7	2.4
5	*5720.00	108.7 AV			2.09 H	130	106.3	2.4
6	#5850.00	51.6 PK	68.2	-16.6	2.09 H	130	48.9	2.7
7	11440.00	54.4 PK	74.0	-19.6	1.03 H	340	42.0	12.4
8	11440.00	44.4 AV	54.0	-9.6	1.03 H	340	32.0	12.4
9	#17160.00	59.3 PK	68.2	-8.9	1.40 H	267	42.7	16.6

Antenna Polarity & Test Distance : Vertical at 3 m								
No	Frequency (MHz)	Emission Level (dBuV/m)	Limit (dBuV/m)	Margin (dB)	Antenna Height (m)	Table Angle (Degree)	Raw Value (dBuV)	Correction Factor (dB/m)
1	5460.00	50.4 PK	74.0	-23.6	1.25 V	99	48.3	2.1
2	5460.00	38.2 AV	54.0	-15.8	1.25 V	99	36.1	2.1
3	#5470.00	51.5 PK	68.2	-16.7	1.25 V	99	49.3	2.2
4	*5720.00	113.9 PK			1.25 V	99	111.5	2.4
5	*5720.00	102.4 AV			1.25 V	99	100.0	2.4
6	#5850.00	50.9 PK	68.2	-17.3	1.25 V	99	48.2	2.7
7	11440.00	54.9 PK	74.0	-19.1	2.17 V	174	42.5	12.4
8	11440.00	46.0 AV	54.0	-8.0	2.17 V	174	33.6	12.4
9	#17160.00	60.0 PK	68.2	-8.2	1.67 V	252	43.4	16.6

Remarks:

1. Emission Level(dBuV/m) = Raw Value(dBuV) + Correction Factor(dB/m)
2. Correction Factor(dB/m) = Antenna Factor(dB/m) + Cable Factor(dB) – Pre-Amplifier Factor(dB)
3. Margin value = Emission Level – Limit value
4. The other emission levels were very low against the limit.
5. " * ": Fundamental frequency.
6. " # ": The radiated frequency is out of the restricted band.

RF Mode	TX 802.11ax (HE20)	Channel	CH 149 : 5745 MHz
Frequency Range	1GHz ~ 40GHz	Detector Function	Peak (PK) Average (AV)

Antenna Polarity & Test Distance : Horizontal at 3 m

No	Frequency (MHz)	Emission Level (dBuV/m)	Limit (dBuV/m)	Margin (dB)	Antenna Height (m)	Table Angle (Degree)	Raw Value (dBuV)	Correction Factor (dB/m)
1	#5647.40	52.2 PK	68.2	-16.0	1.98 H	111	49.9	2.3
2	*5745.00	118.7 PK			1.98 H	111	116.3	2.4
3	*5745.00	108.3 AV			1.98 H	111	105.9	2.4
4	#6002.01	51.5 PK	68.2	-16.7	1.98 H	111	48.6	2.9
5	11490.00	55.0 PK	74.0	-19.0	1.13 H	338	42.4	12.6
6	11490.00	44.8 AV	54.0	-9.2	1.13 H	338	32.2	12.6
7	#17235.00	58.7 PK	68.2	-9.5	1.46 H	290	41.9	16.8

Antenna Polarity & Test Distance : Vertical at 3 m

No	Frequency (MHz)	Emission Level (dBuV/m)	Limit (dBuV/m)	Margin (dB)	Antenna Height (m)	Table Angle (Degree)	Raw Value (dBuV)	Correction Factor (dB/m)
1	#5562.53	50.7 PK	68.2	-17.5	1.43 V	122	48.6	2.1
2	*5745.00	112.1 PK			1.43 V	122	109.7	2.4
3	*5745.00	100.9 AV			1.43 V	122	98.5	2.4
4	#5936.80	50.7 PK	68.2	-17.5	1.43 V	122	47.8	2.9
5	11490.00	54.6 PK	74.0	-19.4	2.25 V	169	42.0	12.6
6	11490.00	45.9 AV	54.0	-8.1	2.25 V	169	33.3	12.6
7	#17235.00	60.1 PK	68.2	-8.1	1.61 V	260	43.3	16.8

Remarks:

1. Emission Level(dBuV/m) = Raw Value(dBuV) + Correction Factor(dB/m)
2. Correction Factor(dB/m) = Antenna Factor(dB/m) + Cable Factor(dB) – Pre-Amplifier Factor(dB)
3. Margin value = Emission Level – Limit value
4. The other emission levels were very low against the limit.
5. " * ": Fundamental frequency.
6. " # ": The radiated frequency is out of the restricted band.

RF Mode	TX 802.11ax (HE20)	Channel	CH 157 : 5785 MHz
Frequency Range	1GHz ~ 40GHz	Detector Function	Peak (PK) Average (AV)

Antenna Polarity & Test Distance : Horizontal at 3 m								
No	Frequency (MHz)	Emission Level (dBuV/m)	Limit (dBuV/m)	Margin (dB)	Antenna Height (m)	Table Angle (Degree)	Raw Value (dBuV)	Correction Factor (dB/m)
1	#5569.62	52.0 PK	68.2	-16.2	1.95 H	122	49.9	2.1
2	*5785.00	118.5 PK			1.95 H	122	115.9	2.6
3	*5785.00	108.1 AV			1.95 H	122	105.5	2.6
4	#5929.17	52.6 PK	68.2	-15.6	1.95 H	122	49.7	2.9
5	11570.00	54.9 PK	74.0	-19.1	1.01 H	360	42.3	12.6
6	11570.00	44.8 AV	54.0	-9.2	1.01 H	360	32.2	12.6
7	#17355.00	58.7 PK	68.2	-9.5	1.45 H	274	41.0	17.7

Antenna Polarity & Test Distance : Vertical at 3 m								
No	Frequency (MHz)	Emission Level (dBuV/m)	Limit (dBuV/m)	Margin (dB)	Antenna Height (m)	Table Angle (Degree)	Raw Value (dBuV)	Correction Factor (dB/m)
1	#5572.92	50.6 PK	68.2	-17.6	1.21 V	120	48.5	2.1
2	*5785.00	112.3 PK			1.21 V	120	109.7	2.6
3	*5785.00	101.1 AV			1.21 V	120	98.5	2.6
4	#5989.40	51.3 PK	68.2	-16.9	1.21 V	120	48.4	2.9
5	11570.00	55.7 PK	74.0	-18.3	2.23 V	191	43.1	12.6
6	11570.00	46.5 AV	54.0	-7.5	2.23 V	191	33.9	12.6
7	#17355.00	59.7 PK	68.2	-8.5	1.63 V	271	42.0	17.7

Remarks:

1. Emission Level(dBuV/m) = Raw Value(dBuV) + Correction Factor(dB/m)
2. Correction Factor(dB/m) = Antenna Factor(dB/m) + Cable Factor(dB) – Pre-Amplifier Factor(dB)
3. Margin value = Emission Level – Limit value
4. The other emission levels were very low against the limit.
5. " * ": Fundamental frequency.
6. " # ": The radiated frequency is out of the restricted band.

RF Mode	TX 802.11ax (HE20)	Channel	CH 165 : 5825 MHz
Frequency Range	1GHz ~ 40GHz	Detector Function	Peak (PK) Average (AV)

Antenna Polarity & Test Distance : Horizontal at 3 m

No	Frequency (MHz)	Emission Level (dBuV/m)	Limit (dBuV/m)	Margin (dB)	Antenna Height (m)	Table Angle (Degree)	Raw Value (dBuV)	Correction Factor (dB/m)
1	#5554.81	51.4 PK	68.2	-16.8	2.02 H	102	49.3	2.1
2	*5825.00	118.3 PK			2.02 H	102	115.7	2.6
3	*5825.00	107.9 AV			2.02 H	102	105.3	2.6
4	#6006.19	51.6 PK	68.2	-16.6	2.02 H	102	48.7	2.9
5	11650.00	55.1 PK	74.0	-18.9	1.03 H	337	42.9	12.2
6	11650.00	45.0 AV	54.0	-9.0	1.03 H	337	32.8	12.2
7	#17475.00	59.1 PK	68.2	-9.1	1.41 H	273	40.4	18.7

Antenna Polarity & Test Distance : Vertical at 3 m

No	Frequency (MHz)	Emission Level (dBuV/m)	Limit (dBuV/m)	Margin (dB)	Antenna Height (m)	Table Angle (Degree)	Raw Value (dBuV)	Correction Factor (dB/m)
1	#5595.08	50.7 PK	68.2	-17.5	1.39 V	129	48.6	2.1
2	*5825.00	112.6 PK			1.39 V	129	110.0	2.6
3	*5825.00	100.6 AV			1.39 V	129	98.0	2.6
4	#6023.36	50.9 PK	68.2	-17.3	1.39 V	129	47.9	3.0
5	11650.00	54.8 PK	74.0	-19.2	2.27 V	166	42.6	12.2
6	11650.00	45.8 AV	54.0	-8.2	2.27 V	166	33.6	12.2
7	#17475.00	59.8 PK	68.2	-8.4	1.62 V	270	41.1	18.7

Remarks:

1. Emission Level(dBuV/m) = Raw Value(dBuV) + Correction Factor(dB/m)
2. Correction Factor(dB/m) = Antenna Factor(dB/m) + Cable Factor(dB) – Pre-Amplifier Factor(dB)
3. Margin value = Emission Level – Limit value
4. The other emission levels were very low against the limit.
5. " * ": Fundamental frequency.
6. " # ": The radiated frequency is out of the restricted band.

RF Mode	TX 802.11ax (HE40)	Channel	CH 38 : 5190 MHz
Frequency Range	1GHz ~ 40GHz	Detector Function	Peak (PK) Average (AV)

Antenna Polarity & Test Distance : Horizontal at 3 m

No	Frequency (MHz)	Emission Level (dBuV/m)	Limit (dBuV/m)	Margin (dB)	Antenna Height (m)	Table Angle (Degree)	Raw Value (dBuV)	Correction Factor (dB/m)
1	5150.00	64.0 PK	74.0	-10.0	1.96 H	124	61.7	2.3
2	5150.00	52.4 AV	54.0	-1.6	1.96 H	124	50.1	2.3
3	*5190.00	112.9 PK			1.96 H	124	110.8	2.1
4	*5190.00	102.8 AV			1.96 H	124	100.7	2.1
5	#10380.00	54.6 PK	68.2	-13.6	1.04 H	351	42.6	12.0
6	15570.00	58.6 PK	74.0	-15.4	1.39 H	272	46.9	11.7
7	15570.00	46.1 AV	54.0	-7.9	1.39 H	272	34.4	11.7

Antenna Polarity & Test Distance : Vertical at 3 m

No	Frequency (MHz)	Emission Level (dBuV/m)	Limit (dBuV/m)	Margin (dB)	Antenna Height (m)	Table Angle (Degree)	Raw Value (dBuV)	Correction Factor (dB/m)
1	5150.00	57.0 PK	74.0	-17.0	1.24 V	102	54.7	2.3
2	5150.00	46.3 AV	54.0	-7.7	1.24 V	102	44.0	2.3
3	*5190.00	106.9 PK			1.24 V	102	104.8	2.1
4	*5190.00	93.9 AV			1.24 V	102	91.8	2.1
5	#10380.00	55.7 PK	68.2	-12.5	2.25 V	163	43.7	12.0
6	15570.00	59.9 PK	74.0	-14.1	1.64 V	257	48.2	11.7
7	15570.00	48.0 AV	54.0	-6.0	1.64 V	257	36.3	11.7

Remarks:

1. Emission Level(dBuV/m) = Raw Value(dBuV) + Correction Factor(dB/m)
2. Correction Factor(dB/m) = Antenna Factor(dB/m) + Cable Factor(dB) – Pre-Amplifier Factor(dB)
3. Margin value = Emission Level – Limit value
4. The other emission levels were very low against the limit.
5. " * ": Fundamental frequency.
6. " # ": The radiated frequency is out of the restricted band.

RF Mode	TX 802.11ax (HE40)	Channel	CH 46 : 5230 MHz
Frequency Range	1GHz ~ 40GHz	Detector Function	Peak (PK) Average (AV)

Antenna Polarity & Test Distance : Horizontal at 3 m

No	Frequency (MHz)	Emission Level (dBuV/m)	Limit (dBuV/m)	Margin (dB)	Antenna Height (m)	Table Angle (Degree)	Raw Value (dBuV)	Correction Factor (dB/m)
1	5150.00	68.3 PK	74.0	-5.7	2.00 H	126	66.0	2.3
2	5150.00	50.0 AV	54.0	-4.0	2.00 H	126	47.7	2.3
3	*5230.00	118.2 PK			2.00 H	126	116.1	2.1
4	*5230.00	108.5 AV			2.00 H	126	106.4	2.1
5	5350.00	61.6 PK	74.0	-12.4	2.00 H	126	59.7	1.9
6	5350.00	42.7 AV	54.0	-11.3	2.00 H	126	40.8	1.9
7	#10460.00	54.8 PK	68.2	-13.4	1.01 H	329	42.8	12.0
8	15690.00	59.1 PK	74.0	-14.9	1.44 H	278	47.2	11.9
9	15690.00	46.6 AV	54.0	-7.4	1.44 H	278	34.7	11.9

Antenna Polarity & Test Distance : Vertical at 3 m

No	Frequency (MHz)	Emission Level (dBuV/m)	Limit (dBuV/m)	Margin (dB)	Antenna Height (m)	Table Angle (Degree)	Raw Value (dBuV)	Correction Factor (dB/m)
1	5150.00	61.2 PK	74.0	-12.8	1.24 V	100	58.9	2.3
2	5150.00	45.2 AV	54.0	-8.8	1.24 V	100	42.9	2.3
3	*5230.00	113.1 PK			1.24 V	100	111.0	2.1
4	*5230.00	100.0 AV			1.24 V	100	97.9	2.1
5	5350.00	58.8 PK	74.0	-15.2	1.24 V	100	56.9	1.9
6	5350.00	41.8 AV	54.0	-12.2	1.24 V	100	39.9	1.9
7	#10460.00	54.6 PK	68.2	-13.6	2.23 V	189	42.6	12.0
8	15690.00	59.7 PK	74.0	-14.3	1.67 V	269	47.8	11.9
9	15690.00	48.0 AV	54.0	-6.0	1.67 V	269	36.1	11.9

Remarks:

1. Emission Level(dBuV/m) = Raw Value(dBuV) + Correction Factor(dB/m)
2. Correction Factor(dB/m) = Antenna Factor(dB/m) + Cable Factor(dB) – Pre-Amplifier Factor(dB)
3. Margin value = Emission Level – Limit value
4. The other emission levels were very low against the limit.
5. " * ": Fundamental frequency.
6. " # ": The radiated frequency is out of the restricted band.

RF Mode	TX 802.11ax (HE40)	Channel	CH 54 : 5270 MHz
Frequency Range	1GHz ~ 40GHz	Detector Function	Peak (PK) Average (AV)

Antenna Polarity & Test Distance : Horizontal at 3 m

No	Frequency (MHz)	Emission Level (dBuV/m)	Limit (dBuV/m)	Margin (dB)	Antenna Height (m)	Table Angle (Degree)	Raw Value (dBuV)	Correction Factor (dB/m)
1	5150.00	54.5 PK	74.0	-19.5	2.04 H	125	52.2	2.3
2	5150.00	40.9 AV	54.0	-13.1	2.04 H	125	38.6	2.3
3	*5270.00	118.5 PK			2.04 H	125	116.6	1.9
4	*5270.00	108.2 AV			2.04 H	125	106.3	1.9
5	5350.00	69.7 PK	74.0	-4.3	2.04 H	125	67.8	1.9
6	5350.00	52.5 AV	54.0	-1.5	2.04 H	125	50.6	1.9
7	#10540.00	55.4 PK	68.2	-12.8	1.01 H	338	43.5	11.9
8	15810.00	59.3 PK	74.0	-14.7	1.44 H	277	47.9	11.4
9	15810.00	46.9 AV	54.0	-7.1	1.44 H	277	35.5	11.4

Antenna Polarity & Test Distance : Vertical at 3 m

No	Frequency (MHz)	Emission Level (dBuV/m)	Limit (dBuV/m)	Margin (dB)	Antenna Height (m)	Table Angle (Degree)	Raw Value (dBuV)	Correction Factor (dB/m)
1	5150.00	53.4 PK	74.0	-20.6	1.19 V	110	51.1	2.3
2	5150.00	39.8 AV	54.0	-14.2	1.19 V	110	37.5	2.3
3	*5270.00	112.5 PK			1.19 V	110	110.6	1.9
4	*5270.00	99.5 AV			1.19 V	110	97.6	1.9
5	5350.00	64.8 PK	74.0	-9.2	1.19 V	110	62.9	1.9
6	5350.00	44.8 AV	54.0	-9.2	1.19 V	110	42.9	1.9
7	#10540.00	54.9 PK	68.2	-13.3	2.17 V	190	43.0	11.9
8	15810.00	59.7 PK	74.0	-14.3	1.63 V	257	48.3	11.4
9	15810.00	47.5 AV	54.0	-6.5	1.63 V	257	36.1	11.4

Remarks:

1. Emission Level(dBuV/m) = Raw Value(dBuV) + Correction Factor(dB/m)
2. Correction Factor(dB/m) = Antenna Factor(dB/m) + Cable Factor(dB) – Pre-Amplifier Factor(dB)
3. Margin value = Emission Level – Limit value
4. The other emission levels were very low against the limit.
5. " * ": Fundamental frequency.
6. " # ": The radiated frequency is out of the restricted band.

RF Mode	TX 802.11ax (HE40)	Channel	CH 62 : 5310 MHz
Frequency Range	1GHz ~ 40GHz	Detector Function	Peak (PK) Average (AV)

Antenna Polarity & Test Distance : Horizontal at 3 m								
No	Frequency (MHz)	Emission Level (dBuV/m)	Limit (dBuV/m)	Margin (dB)	Antenna Height (m)	Table Angle (Degree)	Raw Value (dBuV)	Correction Factor (dB/m)
1	*5310.00	113.2 PK			2.07 H	128	111.4	1.8
2	*5310.00	101.8 AV			2.07 H	128	100.0	1.8
3	5350.00	69.0 PK	74.0	-5.0	2.07 H	128	67.1	1.9
4	5350.00	52.5 AV	54.0	-1.5	2.07 H	128	50.6	1.9
5	10620.00	55.7 PK	74.0	-18.3	1.04 H	337	43.9	11.8
6	10620.00	45.3 AV	54.0	-8.7	1.04 H	337	33.5	11.8
7	15930.00	58.8 PK	74.0	-15.2	1.45 H	274	47.3	11.5
8	15930.00	46.0 AV	54.0	-8.0	1.45 H	274	34.5	11.5
Antenna Polarity & Test Distance : Vertical at 3 m								
No	Frequency (MHz)	Emission Level (dBuV/m)	Limit (dBuV/m)	Margin (dB)	Antenna Height (m)	Table Angle (Degree)	Raw Value (dBuV)	Correction Factor (dB/m)
1	*5310.00	103.9 PK			1.27 V	112	102.1	1.8
2	*5310.00	91.6 AV			1.27 V	112	89.8	1.8
3	5350.00	59.8 PK	74.0	-14.2	1.27 V	112	57.9	1.9
4	5350.00	45.4 AV	54.0	-8.6	1.27 V	112	43.5	1.9
5	10620.00	55.0 PK	74.0	-19.0	2.26 V	163	43.2	11.8
6	10620.00	46.4 AV	54.0	-7.6	2.26 V	163	34.6	11.8
7	15930.00	59.6 PK	74.0	-14.4	1.66 V	280	48.1	11.5
8	15930.00	47.6 AV	54.0	-6.4	1.66 V	280	36.1	11.5

Remarks:

1. Emission Level(dBuV/m) = Raw Value(dBuV) + Correction Factor(dB/m)
2. Correction Factor(dB/m) = Antenna Factor(dB/m) + Cable Factor(dB) – Pre-Amplifier Factor(dB)
3. Margin value = Emission Level – Limit value
4. The other emission levels were very low against the limit.
5. " * ": Fundamental frequency.

RF Mode	TX 802.11ax (HE40)	Channel	CH 102 : 5510 MHz
Frequency Range	1GHz ~ 40GHz	Detector Function	Peak (PK) Average (AV)

Antenna Polarity & Test Distance : Horizontal at 3 m

No	Frequency (MHz)	Emission Level (dBuV/m)	Limit (dBuV/m)	Margin (dB)	Antenna Height (m)	Table Angle (Degree)	Raw Value (dBuV)	Correction Factor (dB/m)
1	5457.60	60.7 PK	74.0	-13.3	1.92 H	127	58.6	2.1
2	5457.60	46.0 AV	54.0	-8.0	1.92 H	127	43.9	2.1
3	5460.00	56.9 PK	74.0	-17.1	1.92 H	127	54.8	2.1
4	5460.00	46.5 AV	54.0	-7.5	1.92 H	127	44.4	2.1
5	#5467.10	66.4 PK	68.2	-1.8	1.92 H	127	64.2	2.2
6	*5510.00	112.5 PK			1.92 H	127	110.4	2.1
7	*5510.00	100.6 AV			1.92 H	127	98.5	2.1
8	11020.00	55.0 PK	74.0	-19.0	1.04 H	327	42.7	12.3
9	11020.00	44.7 AV	54.0	-9.3	1.04 H	327	32.4	12.3
10	#16530.00	59.2 PK	68.2	-9.0	1.47 H	257	45.3	13.9

Antenna Polarity & Test Distance : Vertical at 3 m

No	Frequency (MHz)	Emission Level (dBuV/m)	Limit (dBuV/m)	Margin (dB)	Antenna Height (m)	Table Angle (Degree)	Raw Value (dBuV)	Correction Factor (dB/m)
1	5456.30	53.3 PK	74.0	-20.7	1.16 V	108	51.2	2.1
2	5456.30	40.2 AV	54.0	-13.8	1.16 V	108	38.1	2.1
3	5460.00	50.0 PK	74.0	-24.0	1.16 V	108	47.9	2.1
4	5460.00	40.6 AV	54.0	-13.4	1.16 V	108	38.5	2.1
5	#5467.30	57.7 PK	68.2	-10.5	1.16 V	108	55.5	2.2
6	*5510.00	103.2 PK			1.16 V	108	101.1	2.1
7	*5510.00	91.4 AV			1.16 V	108	89.3	2.1
8	11020.00	55.8 PK	74.0	-18.2	2.23 V	165	43.5	12.3
9	11020.00	46.6 AV	54.0	-7.4	2.23 V	165	34.3	12.3
10	#16530.00	59.8 PK	68.2	-8.4	1.71 V	260	45.9	13.9

Remarks:

1. Emission Level(dBuV/m) = Raw Value(dBuV) + Correction Factor(dB/m)
2. Correction Factor(dB/m) = Antenna Factor(dB/m) + Cable Factor(dB) – Pre-Amplifier Factor(dB)
3. Margin value = Emission Level – Limit value
4. The other emission levels were very low against the limit.
5. " * ": Fundamental frequency.
6. " # ": The radiated frequency is out of the restricted band.

RF Mode	TX 802.11ax (HE40)	Channel	CH 110 : 5550 MHz
Frequency Range	1GHz ~ 40GHz	Detector Function	Peak (PK) Average (AV)

Antenna Polarity & Test Distance : Horizontal at 3 m								
No	Frequency (MHz)	Emission Level (dBuV/m)	Limit (dBuV/m)	Margin (dB)	Antenna Height (m)	Table Angle (Degree)	Raw Value (dBuV)	Correction Factor (dB/m)
1	5460.00	58.6 PK	74.0	-15.4	1.99 H	137	56.5	2.1
2	5460.00	44.1 AV	54.0	-9.9	1.99 H	137	42.0	2.1
3	#5470.00	63.7 PK	68.2	-4.5	1.99 H	137	61.5	2.2
4	*5550.00	118.0 PK			1.99 H	137	115.9	2.1
5	*5550.00	107.9 AV			1.99 H	137	105.8	2.1
6	11100.00	55.6 PK	74.0	-18.4	1.01 H	336	43.7	11.9
7	11100.00	45.3 AV	54.0	-8.7	1.01 H	336	33.4	11.9
8	#16650.00	59.4 PK	68.2	-8.8	1.42 H	270	44.6	14.8
Antenna Polarity & Test Distance : Vertical at 3 m								
No	Frequency (MHz)	Emission Level (dBuV/m)	Limit (dBuV/m)	Margin (dB)	Antenna Height (m)	Table Angle (Degree)	Raw Value (dBuV)	Correction Factor (dB/m)
1	5460.00	54.3 PK	74.0	-19.7	1.23 V	102	52.2	2.1
2	5460.00	40.4 AV	54.0	-13.6	1.23 V	102	38.3	2.1
3	#5470.00	56.1 PK	68.2	-12.1	1.23 V	102	53.9	2.2
4	*5550.00	112.9 PK			1.23 V	102	110.8	2.1
5	*5550.00	99.7 AV			1.23 V	102	97.6	2.1
6	11100.00	55.5 PK	74.0	-18.5	2.18 V	164	43.6	11.9
7	11100.00	46.6 AV	54.0	-7.4	2.18 V	164	34.7	11.9
8	#16650.00	60.1 PK	68.2	-8.1	1.69 V	274	45.3	14.8

Remarks:

1. Emission Level(dBuV/m) = Raw Value(dBuV) + Correction Factor(dB/m)
2. Correction Factor(dB/m) = Antenna Factor(dB/m) + Cable Factor(dB) – Pre-Amplifier Factor(dB)
3. Margin value = Emission Level – Limit value
4. The other emission levels were very low against the limit.
5. " * ": Fundamental frequency.
6. " # ": The radiated frequency is out of the restricted band.

RF Mode	TX 802.11ax (HE40)	Channel	CH 134 : 5670 MHz
Frequency Range	1GHz ~ 40GHz	Detector Function	Peak (PK) Average (AV)

Antenna Polarity & Test Distance : Horizontal at 3 m

No	Frequency (MHz)	Emission Level (dBuV/m)	Limit (dBuV/m)	Margin (dB)	Antenna Height (m)	Table Angle (Degree)	Raw Value (dBuV)	Correction Factor (dB/m)
1	*5670.00	116.6 PK			2.06 H	116	114.3	2.3
2	*5670.00	104.7 AV			2.06 H	116	102.4	2.3
3	#5736.44	66.7 PK	68.2	-1.5	2.06 H	116	64.2	2.5
4	11340.00	54.4 PK	74.0	-19.6	1.01 H	330	42.2	12.2
5	11340.00	44.5 AV	54.0	-9.5	1.01 H	330	32.3	12.2
6	#17010.00	59.1 PK	68.2	-9.1	1.40 H	274	42.5	16.6

Antenna Polarity & Test Distance : Vertical at 3 m

No	Frequency (MHz)	Emission Level (dBuV/m)	Limit (dBuV/m)	Margin (dB)	Antenna Height (m)	Table Angle (Degree)	Raw Value (dBuV)	Correction Factor (dB/m)
1	*5670.00	109.8 PK			1.21 V	95	107.5	2.3
2	*5670.00	96.9 AV			1.21 V	95	94.6	2.3
3	#5725.00	56.3 PK	68.2	-11.9	1.21 V	95	53.9	2.4
4	11340.00	55.3 PK	74.0	-18.7	2.23 V	176	43.1	12.2
5	11340.00	46.2 AV	54.0	-7.8	2.23 V	176	34.0	12.2
6	#17010.00	59.9 PK	68.2	-8.3	1.64 V	260	43.3	16.6

Remarks:

1. Emission Level(dBuV/m) = Raw Value(dBuV) + Correction Factor(dB/m)
2. Correction Factor(dB/m) = Antenna Factor(dB/m) + Cable Factor(dB) – Pre-Amplifier Factor(dB)
3. Margin value = Emission Level – Limit value
4. The other emission levels were very low against the limit.
5. " * ": Fundamental frequency.
6. " # ": The radiated frequency is out of the restricted band.

RF Mode	TX 802.11ax (HE40)	Channel	CH 142 : 5710 MHz
Frequency Range	1GHz ~ 40GHz	Detector Function	Peak (PK) Average (AV)

Antenna Polarity & Test Distance : Horizontal at 3 m

No	Frequency (MHz)	Emission Level (dBuV/m)	Limit (dBuV/m)	Margin (dB)	Antenna Height (m)	Table Angle (Degree)	Raw Value (dBuV)	Correction Factor (dB/m)
1	5460.00	51.2 PK	74.0	-22.8	1.94 H	129	49.1	2.1
2	5460.00	39.4 AV	54.0	-14.6	1.94 H	129	37.3	2.1
3	#5470.00	52.2 PK	68.2	-16.0	1.94 H	129	50.0	2.2
4	*5710.00	118.2 PK			1.94 H	129	115.8	2.4
5	*5710.00	105.4 AV			1.94 H	129	103.0	2.4
6	#5850.00	58.7 PK	68.2	-9.5	1.94 H	129	56.0	2.7
7	11420.00	55.3 PK	74.0	-18.7	1.00 H	324	42.8	12.5
8	11420.00	45.2 AV	54.0	-8.8	1.00 H	324	32.7	12.5
9	#17130.00	59.6 PK	68.2	-8.6	1.37 H	257	42.8	16.8

Antenna Polarity & Test Distance : Vertical at 3 m

No	Frequency (MHz)	Emission Level (dBuV/m)	Limit (dBuV/m)	Margin (dB)	Antenna Height (m)	Table Angle (Degree)	Raw Value (dBuV)	Correction Factor (dB/m)
1	5460.00	50.5 PK	74.0	-23.5	1.24 V	85	48.4	2.1
2	5460.00	38.1 AV	54.0	-15.9	1.24 V	85	36.0	2.1
3	#5470.00	51.5 PK	68.2	-16.7	1.24 V	85	49.3	2.2
4	*5710.00	112.5 PK			1.24 V	85	110.1	2.4
5	*5710.00	99.4 AV			1.24 V	85	97.0	2.4
6	#5850.00	55.5 PK	68.2	-12.7	1.24 V	85	52.8	2.7
7	11420.00	55.4 PK	74.0	-18.6	2.23 V	172	42.9	12.5
8	11420.00	46.6 AV	54.0	-7.4	2.23 V	172	34.1	12.5
9	#17130.00	59.6 PK	68.2	-8.6	1.59 V	273	42.8	16.8

Remarks:

1. Emission Level(dBuV/m) = Raw Value(dBuV) + Correction Factor(dB/m)
2. Correction Factor(dB/m) = Antenna Factor(dB/m) + Cable Factor(dB) – Pre-Amplifier Factor(dB)
3. Margin value = Emission Level – Limit value
4. The other emission levels were very low against the limit.
5. " * ": Fundamental frequency.
6. " # ": The radiated frequency is out of the restricted band.

RF Mode	TX 802.11ax (HE40)	Channel	CH 151 : 5755 MHz
Frequency Range	1GHz ~ 40GHz	Detector Function	Peak (PK) Average (AV)

Antenna Polarity & Test Distance : Horizontal at 3 m

No	Frequency (MHz)	Emission Level (dBuV/m)	Limit (dBuV/m)	Margin (dB)	Antenna Height (m)	Table Angle (Degree)	Raw Value (dBuV)	Correction Factor (dB/m)
1	#5641.97	55.3 PK	68.2	-12.9	1.99 H	128	53.0	2.3
2	*5755.00	118.3 PK			1.99 H	128	115.8	2.5
3	*5755.00	105.1 AV			1.99 H	128	102.6	2.5
4	#6003.62	52.6 PK	68.2	-15.6	1.99 H	128	49.7	2.9
5	11510.00	54.7 PK	74.0	-19.3	1.04 H	326	42.1	12.6
6	11510.00	44.6 AV	54.0	-9.4	1.04 H	326	32.0	12.6
7	#17265.00	59.5 PK	68.2	-8.7	1.38 H	276	42.6	16.9

Antenna Polarity & Test Distance : Vertical at 3 m

No	Frequency (MHz)	Emission Level (dBuV/m)	Limit (dBuV/m)	Margin (dB)	Antenna Height (m)	Table Angle (Degree)	Raw Value (dBuV)	Correction Factor (dB/m)
1	#5648.84	52.3 PK	68.2	-15.9	1.23 V	119	50.0	2.3
2	*5755.00	108.1 PK			1.23 V	119	105.6	2.5
3	*5755.00	95.6 AV			1.23 V	119	93.1	2.5
4	#5926.07	50.7 PK	68.2	-17.5	1.23 V	119	47.8	2.9
5	11510.00	55.6 PK	74.0	-18.4	2.24 V	167	43.0	12.6
6	11510.00	46.5 AV	54.0	-7.5	2.24 V	167	33.9	12.6
7	#17265.00	59.3 PK	68.2	-8.9	1.62 V	254	42.4	16.9

Remarks:

1. Emission Level(dBuV/m) = Raw Value(dBuV) + Correction Factor(dB/m)
2. Correction Factor(dB/m) = Antenna Factor(dB/m) + Cable Factor(dB) – Pre-Amplifier Factor(dB)
3. Margin value = Emission Level – Limit value
4. The other emission levels were very low against the limit.
5. " * ": Fundamental frequency.
6. " # ": The radiated frequency is out of the restricted band.

RF Mode	TX 802.11ax (HE40)	Channel	CH 159 : 5795 MHz
Frequency Range	1GHz ~ 40GHz	Detector Function	Peak (PK) Average (AV)

Antenna Polarity & Test Distance : Horizontal at 3 m

No	Frequency (MHz)	Emission Level (dBuV/m)	Limit (dBuV/m)	Margin (dB)	Antenna Height (m)	Table Angle (Degree)	Raw Value (dBuV)	Correction Factor (dB/m)
1	#5568.25	52.5 PK	68.2	-15.7	1.98 H	127	50.4	2.1
2	*5795.00	117.9 PK			1.98 H	127	115.3	2.6
3	*5795.00	105.0 AV			1.98 H	127	102.4	2.6
4	#5957.04	55.1 PK	68.2	-13.1	1.98 H	127	52.2	2.9
5	11590.00	55.3 PK	74.0	-18.7	1.02 H	333	42.7	12.6
6	11590.00	45.0 AV	54.0	-9.0	1.02 H	333	32.4	12.6
7	#17385.00	58.5 PK	68.2	-9.7	1.44 H	265	40.6	17.9

Antenna Polarity & Test Distance : Vertical at 3 m

No	Frequency (MHz)	Emission Level (dBuV/m)	Limit (dBuV/m)	Margin (dB)	Antenna Height (m)	Table Angle (Degree)	Raw Value (dBuV)	Correction Factor (dB/m)
1	#5597.67	50.1 PK	68.2	-18.1	1.26 V	118	48.0	2.1
2	*5795.00	107.9 PK			1.26 V	118	105.3	2.6
3	*5795.00	95.1 AV			1.26 V	118	92.5	2.6
4	#5929.60	51.9 PK	68.2	-16.3	1.26 V	118	49.0	2.9
5	11590.00	55.3 PK	74.0	-18.7	2.20 V	180	42.7	12.6
6	11590.00	46.5 AV	54.0	-7.5	2.20 V	180	33.9	12.6
7	#17385.00	59.8 PK	68.2	-8.4	1.69 V	265	41.9	17.9

Remarks:

1. Emission Level(dBuV/m) = Raw Value(dBuV) + Correction Factor(dB/m)
2. Correction Factor(dB/m) = Antenna Factor(dB/m) + Cable Factor(dB) – Pre-Amplifier Factor(dB)
3. Margin value = Emission Level – Limit value
4. The other emission levels were very low against the limit.
5. " * ": Fundamental frequency.
6. " # ": The radiated frequency is out of the restricted band.

RF Mode	TX 802.11ax (HE80)	Channel	CH 42 : 5210 MHz
Frequency Range	1GHz ~ 40GHz	Detector Function	Peak (PK) Average (AV)

Antenna Polarity & Test Distance : Horizontal at 3 m

No	Frequency (MHz)	Emission Level (dBuV/m)	Limit (dBuV/m)	Margin (dB)	Antenna Height (m)	Table Angle (Degree)	Raw Value (dBuV)	Correction Factor (dB/m)
1	5147.83	65.9 PK	74.0	-8.1	2.05 H	119	63.6	2.3
2	5147.83	52.2 AV	54.0	-1.8	2.05 H	119	49.9	2.3
3	*5210.00	109.3 PK			2.05 H	119	107.2	2.1
4	*5210.00	97.3 AV			2.05 H	119	95.2	2.1
5	5350.00	53.0 PK	74.0	-21.0	2.05 H	119	51.1	1.9
6	5350.00	40.0 AV	54.0	-14.0	2.05 H	119	38.1	1.9
7	#10420.00	55.1 PK	68.2	-13.1	1.08 H	327	43.0	12.1
8	15630.00	58.6 PK	74.0	-15.4	1.37 H	278	46.9	11.7
9	15630.00	46.2 AV	54.0	-7.8	1.37 H	278	34.5	11.7

Antenna Polarity & Test Distance : Vertical at 3 m

No	Frequency (MHz)	Emission Level (dBuV/m)	Limit (dBuV/m)	Margin (dB)	Antenna Height (m)	Table Angle (Degree)	Raw Value (dBuV)	Correction Factor (dB/m)
1	5147.10	56.7 PK	74.0	-17.3	1.27 V	108	54.4	2.3
2	5147.10	44.7 AV	54.0	-9.3	1.27 V	108	42.4	2.3
3	*5210.00	98.8 PK			1.27 V	108	96.7	2.1
4	*5210.00	86.4 AV			1.27 V	108	84.3	2.1
5	5353.00	49.7 PK	74.0	-24.3	1.27 V	108	47.8	1.9
6	5353.00	38.6 AV	54.0	-15.4	1.27 V	108	36.7	1.9
7	#10420.00	55.2 PK	68.2	-13.0	2.20 V	169	43.1	12.1
8	15630.00	60.5 PK	74.0	-13.5	1.70 V	275	48.8	11.7
9	15630.00	48.3 AV	54.0	-5.7	1.70 V	275	36.6	11.7

Remarks:

1. Emission Level(dBuV/m) = Raw Value(dBuV) + Correction Factor(dB/m)
2. Correction Factor(dB/m) = Antenna Factor(dB/m) + Cable Factor(dB) – Pre-Amplifier Factor(dB)
3. Margin value = Emission Level – Limit value
4. The other emission levels were very low against the limit.
5. " * " : Fundamental frequency.
6. " # " : The radiated frequency is out of the restricted band.

RF Mode	TX 802.11ax (HE80)	Channel	CH 58 : 5290 MHz
Frequency Range	1GHz ~ 40GHz	Detector Function	Peak (PK) Average (AV)

Antenna Polarity & Test Distance : Horizontal at 3 m

No	Frequency (MHz)	Emission Level (dBuV/m)	Limit (dBuV/m)	Margin (dB)	Antenna Height (m)	Table Angle (Degree)	Raw Value (dBuV)	Correction Factor (dB/m)
1	5146.90	54.4 PK	74.0	-19.6	2.00 H	123	52.1	2.3
2	5146.90	40.9 AV	54.0	-13.1	2.00 H	123	38.6	2.3
3	*5290.00	108.9 PK			2.00 H	123	107.1	1.8
4	*5290.00	96.6 AV			2.00 H	123	94.8	1.8
5	5354.40	66.1 PK	74.0	-7.9	2.00 H	123	64.1	2.0
6	5354.40	52.4 AV	54.0	-1.6	2.00 H	123	50.4	2.0
7	5356.90	67.7 PK	74.0	-6.3	2.00 H	123	65.7	2.0
8	5356.90	51.6 AV	54.0	-2.4	2.00 H	123	49.6	2.0
9	#10580.00	55.2 PK	68.2	-13.0	1.06 H	341	43.4	11.8
10	15870.00	58.8 PK	74.0	-15.2	1.37 H	262	47.5	11.3
11	15870.00	46.5 AV	54.0	-7.5	1.37 H	262	35.2	11.3

Antenna Polarity & Test Distance : Vertical at 3 m

No	Frequency (MHz)	Emission Level (dBuV/m)	Limit (dBuV/m)	Margin (dB)	Antenna Height (m)	Table Angle (Degree)	Raw Value (dBuV)	Correction Factor (dB/m)
1	5100.10	51.3 PK	74.0	-22.7	1.17 V	104	49.0	2.3
2	5100.10	39.7 AV	54.0	-14.3	1.17 V	104	37.4	2.3
3	*5290.00	100.1 PK			1.17 V	104	98.3	1.8
4	*5290.00	88.3 AV			1.17 V	104	86.5	1.8
5	5350.00	57.5 PK	74.0	-16.5	1.17 V	104	55.6	1.9
6	5350.00	46.6 AV	54.0	-7.4	1.17 V	104	44.7	1.9
7	5359.00	59.9 PK	74.0	-14.1	1.17 V	104	57.9	2.0
8	5359.00	45.6 AV	54.0	-8.4	1.17 V	104	43.6	2.0
9	#10580.00	54.7 PK	68.2	-13.5	2.19 V	166	42.9	11.8
10	15870.00	59.6 PK	74.0	-14.4	1.69 V	259	48.3	11.3
11	15870.00	47.7 AV	54.0	-6.3	1.69 V	259	36.4	11.3

Remarks:

1. Emission Level(dBuV/m) = Raw Value(dBuV) + Correction Factor(dB/m)
2. Correction Factor(dB/m) = Antenna Factor(dB/m) + Cable Factor(dB) – Pre-Amplifier Factor(dB)
3. Margin value = Emission Level – Limit value
4. The other emission levels were very low against the limit.
5. " * " : Fundamental frequency.
6. " # " : The radiated frequency is out of the restricted band.

RF Mode	TX 802.11ax (HE80)	Channel	CH 106 : 5530 MHz
Frequency Range	1GHz ~ 40GHz	Detector Function	Peak (PK) Average (AV)

Antenna Polarity & Test Distance : Horizontal at 3 m

No	Frequency (MHz)	Emission Level (dBuV/m)	Limit (dBuV/m)	Margin (dB)	Antenna Height (m)	Table Angle (Degree)	Raw Value (dBuV)	Correction Factor (dB/m)
1	#5465.80	66.5 PK	68.2	-1.7	1.98 H	119	64.4	2.1
2	#5485.10	64.1 PK	68.2	-4.1	1.98 H	119	62.0	2.1
3	*5530.00	108.5 PK			1.98 H	119	106.5	2.0
4	*5530.00	95.2 AV			1.98 H	119	93.2	2.0
5	#5841.45	51.2 PK	68.2	-17.0	1.98 H	119	48.5	2.7
6	11060.00	55.4 PK	74.0	-18.6	1.00 H	346	43.3	12.1
7	11060.00	45.5 AV	54.0	-8.5	1.00 H	346	33.4	12.1
8	#16590.00	59.4 PK	68.2	-8.8	1.37 H	267	45.1	14.3

Antenna Polarity & Test Distance : Vertical at 3 m

No	Frequency (MHz)	Emission Level (dBuV/m)	Limit (dBuV/m)	Margin (dB)	Antenna Height (m)	Table Angle (Degree)	Raw Value (dBuV)	Correction Factor (dB/m)
1	5453.40	52.0 PK	74.0	-22.0	1.26 V	110	49.9	2.1
2	5453.40	40.8 AV	54.0	-13.2	1.26 V	110	38.7	2.1
3	5460.00	50.4 PK	74.0	-23.6	1.26 V	110	48.3	2.1
4	5460.00	41.1 AV	54.0	-12.9	1.26 V	110	39.0	2.1
5	#5469.60	58.2 PK	68.2	-10.0	1.26 V	110	56.0	2.2
6	*5530.00	98.2 PK			1.26 V	110	96.2	2.0
7	*5530.00	85.8 AV			1.26 V	110	83.8	2.0
8	#5775.10	51.5 PK	68.2	-16.7	1.26 V	110	49.0	2.5
9	11060.00	55.2 PK	74.0	-18.8	2.20 V	190	43.1	12.1
10	11060.00	46.3 AV	54.0	-7.7	2.20 V	190	34.2	12.1
11	#16590.00	60.3 PK	68.2	-7.9	1.61 V	267	46.0	14.3

Remarks:

1. Emission Level(dBuV/m) = Raw Value(dBuV) + Correction Factor(dB/m)
2. Correction Factor(dB/m) = Antenna Factor(dB/m) + Cable Factor(dB) – Pre-Amplifier Factor(dB)
3. Margin value = Emission Level – Limit value
4. The other emission levels were very low against the limit.
5. " * ": Fundamental frequency.
6. " # ": The radiated frequency is out of the restricted band.

RF Mode	TX 802.11ax (HE80)	Channel	CH 122 : 5610 MHz
Frequency Range	1GHz ~ 40GHz	Detector Function	Peak (PK) Average (AV)

Antenna Polarity & Test Distance : Horizontal at 3 m

No	Frequency (MHz)	Emission Level (dBuV/m)	Limit (dBuV/m)	Margin (dB)	Antenna Height (m)	Table Angle (Degree)	Raw Value (dBuV)	Correction Factor (dB/m)
1	*5610.00	109.9 PK			2.01 H	122	107.8	2.1
2	*5610.00	98.4 AV			2.01 H	122	96.3	2.1
3	#5725.00	66.5 PK	68.2	-1.7	2.01 H	122	64.1	2.4
4	11220.00	55.5 PK	74.0	-18.5	1.09 H	325	43.4	12.1
5	11220.00	45.3 AV	54.0	-8.7	1.09 H	325	33.2	12.1
6	#16830.00	59.1 PK	68.2	-9.1	1.41 H	264	43.3	15.8

Antenna Polarity & Test Distance : Vertical at 3 m

No	Frequency (MHz)	Emission Level (dBuV/m)	Limit (dBuV/m)	Margin (dB)	Antenna Height (m)	Table Angle (Degree)	Raw Value (dBuV)	Correction Factor (dB/m)
1	*5610.00	102.3 PK			1.23 V	125	100.2	2.1
2	*5610.00	90.4 AV			1.23 V	125	88.3	2.1
3	#5725.00	58.3 PK	68.2	-9.9	1.23 V	125	55.9	2.4
4	11220.00	55.1 PK	74.0	-18.9	2.27 V	170	43.0	12.1
5	11220.00	46.3 AV	54.0	-7.7	2.27 V	170	34.2	12.1
6	#16830.00	60.5 PK	68.2	-7.7	1.65 V	283	44.7	15.8

Remarks:

1. Emission Level(dBuV/m) = Raw Value(dBuV) + Correction Factor(dB/m)
2. Correction Factor(dB/m) = Antenna Factor(dB/m) + Cable Factor(dB) – Pre-Amplifier Factor(dB)
3. Margin value = Emission Level – Limit value
4. The other emission levels were very low against the limit.
5. " * " : Fundamental frequency.
6. " # " : The radiated frequency is out of the restricted band.

RF Mode	TX 802.11ax (HE80)	Channel	CH 138 : 5690 MHz
Frequency Range	1GHz ~ 40GHz	Detector Function	Peak (PK) Average (AV)

Antenna Polarity & Test Distance : Horizontal at 3 m

No	Frequency (MHz)	Emission Level (dBuV/m)	Limit (dBuV/m)	Margin (dB)	Antenna Height (m)	Table Angle (Degree)	Raw Value (dBuV)	Correction Factor (dB/m)
1	5460.00	52.7 PK	74.0	-21.3	1.99 H	124	50.6	2.1
2	5460.00	39.7 AV	54.0	-14.3	1.99 H	124	37.6	2.1
3	#5470.00	56.5 PK	68.2	-11.7	1.99 H	124	54.3	2.2
4	*5690.00	111.4 PK			1.99 H	124	109.1	2.3
5	*5690.00	99.9 AV			1.99 H	124	97.6	2.3
6	#5850.00	66.3 PK	68.2	-1.9	1.99 H	124	63.6	2.7
7	11380.00	55.3 PK	74.0	-18.7	1.09 H	329	42.9	12.4
8	11380.00	45.4 AV	54.0	-8.6	1.09 H	329	33.0	12.4
9	#17070.00	59.0 PK	68.2	-9.2	1.35 H	270	42.2	16.8

Antenna Polarity & Test Distance : Vertical at 3 m

No	Frequency (MHz)	Emission Level (dBuV/m)	Limit (dBuV/m)	Margin (dB)	Antenna Height (m)	Table Angle (Degree)	Raw Value (dBuV)	Correction Factor (dB/m)
1	5460.00	51.9 PK	74.0	-22.1	1.22 V	132	49.8	2.1
2	5460.00	38.8 AV	54.0	-15.2	1.22 V	132	36.7	2.1
3	#5470.00	54.8 PK	68.2	-13.4	1.22 V	132	52.6	2.2
4	*5690.00	102.8 PK			1.22 V	132	100.5	2.3
5	*5690.00	91.0 AV			1.22 V	132	88.7	2.3
6	#5850.00	59.3 PK	68.2	-8.9	1.22 V	132	56.6	2.7
7	11380.00	54.6 PK	74.0	-19.4	2.16 V	175	42.2	12.4
8	11380.00	46.0 AV	54.0	-8.0	2.16 V	175	33.6	12.4
9	#17070.00	59.6 PK	68.2	-8.6	1.62 V	257	42.8	16.8

Remarks:

1. Emission Level(dBuV/m) = Raw Value(dBuV) + Correction Factor(dB/m)
2. Correction Factor(dB/m) = Antenna Factor(dB/m) + Cable Factor(dB) – Pre-Amplifier Factor(dB)
3. Margin value = Emission Level – Limit value
4. The other emission levels were very low against the limit.
5. " * ": Fundamental frequency.
6. " # ": The radiated frequency is out of the restricted band.

RF Mode	TX 802.11ax (HE80)	Channel	CH 155 : 5775 MHz
Frequency Range	1GHz ~ 40GHz	Detector Function	Peak (PK) Average (AV)

Antenna Polarity & Test Distance : Horizontal at 3 m

No	Frequency (MHz)	Emission Level (dBuV/m)	Limit (dBuV/m)	Margin (dB)	Antenna Height (m)	Table Angle (Degree)	Raw Value (dBuV)	Correction Factor (dB/m)
1	#5632.21	66.1 PK	68.2	-2.1	1.97 H	121	63.8	2.3
2	*5775.00	111.7 PK			1.97 H	121	109.2	2.5
3	*5775.00	99.8 AV			1.97 H	121	97.3	2.5
4	#5929.56	66.7 PK	68.2	-1.5	1.97 H	121	63.8	2.9
5	11550.00	54.9 PK	74.0	-19.1	1.02 H	349	42.4	12.5
6	11550.00	44.7 AV	54.0	-9.3	1.02 H	349	32.2	12.5
7	#17325.00	58.6 PK	68.2	-9.6	1.41 H	287	41.3	17.3

Antenna Polarity & Test Distance : Vertical at 3 m

No	Frequency (MHz)	Emission Level (dBuV/m)	Limit (dBuV/m)	Margin (dB)	Antenna Height (m)	Table Angle (Degree)	Raw Value (dBuV)	Correction Factor (dB/m)
1	#5643.65	61.4 PK	68.2	-6.8	1.19 V	119	59.1	2.3
2	*5775.00	103.4 PK			1.19 V	119	100.9	2.5
3	*5775.00	90.2 AV			1.19 V	119	87.7	2.5
4	#5928.97	60.2 PK	68.2	-8.0	1.19 V	119	57.3	2.9
5	11550.00	55.3 PK	74.0	-18.7	2.26 V	189	42.8	12.5
6	11550.00	46.3 AV	54.0	-7.7	2.26 V	189	33.8	12.5
7	#17325.00	60.1 PK	68.2	-8.1	1.70 V	256	42.8	17.3

Remarks:

1. Emission Level(dBuV/m) = Raw Value(dBuV) + Correction Factor(dB/m)
2. Correction Factor(dB/m) = Antenna Factor(dB/m) + Cable Factor(dB) – Pre-Amplifier Factor(dB)
3. Margin value = Emission Level – Limit value
4. The other emission levels were very low against the limit.
5. " * ": Fundamental frequency.
6. " # ": The radiated frequency is out of the restricted band.

RF Mode	TX 20MHz Preamble 802.11ax (RU26)	Channel	CH 36 : 5180 MHz
Frequency Range	1GHz ~ 40GHz	Detector Function	Peak (PK) Average (AV)

Antenna Polarity & Test Distance : Horizontal at 3 m

No	Frequency (MHz)	Emission Level (dBuV/m)	Limit (dBuV/m)	Margin (dB)	Antenna Height (m)	Table Angle (Degree)	Raw Value (dBuV)	Correction Factor (dB/m)
1	5131.80	57.6 PK	74.0	-16.4	2.02 H	120	55.3	2.3
2	5131.80	48.5 AV	54.0	-5.5	2.02 H	120	46.2	2.3
3	5141.10	62.9 PK	74.0	-11.1	2.02 H	120	60.6	2.3
4	5141.10	42.8 AV	54.0	-11.2	2.02 H	120	40.5	2.3
5	*5180.00	125.9 PK			2.02 H	120	123.7	2.2
6	*5180.00	116.2 AV			2.02 H	120	114.0	2.2
7	#10360.00	58.1 PK	68.2	-10.1	2.68 H	316	46.3	11.8
8	15540.00	62.1 PK	74.0	-11.9	1.51 H	282	50.3	11.8
9	15540.00	48.8 AV	54.0	-5.2	1.51 H	282	37.0	11.8

Antenna Polarity & Test Distance : Vertical at 3 m

No	Frequency (MHz)	Emission Level (dBuV/m)	Limit (dBuV/m)	Margin (dB)	Antenna Height (m)	Table Angle (Degree)	Raw Value (dBuV)	Correction Factor (dB/m)
1	5145.50	60.8 PK	74.0	-13.2	1.57 V	124	58.5	2.3
2	5145.50	40.0 AV	54.0	-14.0	1.57 V	124	37.7	2.3
3	5147.50	52.0 PK	74.0	-22.0	1.57 V	124	49.7	2.3
4	5147.50	40.5 AV	54.0	-13.5	1.57 V	124	38.2	2.3
5	*5180.00	115.9 PK			1.57 V	124	113.7	2.2
6	*5180.00	106.9 AV			1.57 V	124	104.7	2.2
7	#10360.00	59.8 PK	68.2	-8.4	2.64 V	323	48.0	11.8
8	15540.00	63.4 PK	74.0	-10.6	1.38 V	270	51.6	11.8
9	15540.00	50.4 AV	54.0	-3.6	1.38 V	270	38.6	11.8

Remarks:

1. Emission Level(dBuV/m) = Raw Value(dBuV) + Correction Factor(dB/m)
2. Correction Factor(dB/m) = Antenna Factor(dB/m) + Cable Factor(dB) – Pre-Amplifier Factor(dB)
3. Margin value = Emission Level – Limit value
4. The other emission levels were very low against the limit.
5. " * ": Fundamental frequency.
6. " # ": The radiated frequency is out of the restricted band.

RF Mode	TX 20MHz Preamble 802.11ax (RU26)	Channel	CH 40 : 5200 MHz
Frequency Range	1GHz ~ 40GHz	Detector Function	Peak (PK) Average (AV)

Antenna Polarity & Test Distance : Horizontal at 3 m

No	Frequency (MHz)	Emission Level (dBuV/m)	Limit (dBuV/m)	Margin (dB)	Antenna Height (m)	Table Angle (Degree)	Raw Value (dBuV)	Correction Factor (dB/m)
1	5150.00	53.7 PK	74.0	-20.3	2.04 H	116	51.4	2.3
2	5150.00	43.1 AV	54.0	-10.9	2.04 H	116	40.8	2.3
3	*5200.00	126.3 PK			2.04 H	116	124.2	2.1
4	*5200.00	116.7 AV			2.04 H	116	114.6	2.1
5	#10400.00	58.9 PK	68.2	-9.3	2.68 H	321	46.9	12.0
6	15600.00	62.3 PK	74.0	-11.7	1.50 H	298	50.8	11.5
7	15600.00	49.3 AV	54.0	-4.7	1.50 H	298	37.8	11.5

Antenna Polarity & Test Distance : Vertical at 3 m

No	Frequency (MHz)	Emission Level (dBuV/m)	Limit (dBuV/m)	Margin (dB)	Antenna Height (m)	Table Angle (Degree)	Raw Value (dBuV)	Correction Factor (dB/m)
1	5150.00	52.3 PK	74.0	-21.7	1.54 V	129	50.0	2.3
2	5150.00	41.6 AV	54.0	-12.4	1.54 V	129	39.3	2.3
3	*5200.00	116.4 PK			1.54 V	129	114.3	2.1
4	*5200.00	107.4 AV			1.54 V	129	105.3	2.1
5	#10400.00	60.2 PK	68.2	-8.0	2.58 V	315	48.2	12.0
6	15600.00	63.9 PK	74.0	-10.1	1.37 V	285	52.4	11.5
7	15600.00	50.8 AV	54.0	-3.2	1.37 V	285	39.3	11.5

Remarks:

1. Emission Level(dBuV/m) = Raw Value(dBuV) + Correction Factor(dB/m)
2. Correction Factor(dB/m) = Antenna Factor(dB/m) + Cable Factor(dB) – Pre-Amplifier Factor(dB)
3. Margin value = Emission Level – Limit value
4. The other emission levels were very low against the limit.
5. " * ": Fundamental frequency.
6. " # ": The radiated frequency is out of the restricted band.

RF Mode	TX 20MHz Preamble 802.11ax (RU26)	Channel	CH 48 : 5240 MHz
Frequency Range	1GHz ~ 40GHz	Detector Function	Peak (PK) Average (AV)

Antenna Polarity & Test Distance : Horizontal at 3 m

No	Frequency (MHz)	Emission Level (dBuV/m)	Limit (dBuV/m)	Margin (dB)	Antenna Height (m)	Table Angle (Degree)	Raw Value (dBuV)	Correction Factor (dB/m)
1	5150.00	52.0 PK	74.0	-22.0	2.02 H	121	49.7	2.3
2	5150.00	38.4 AV	54.0	-15.6	2.02 H	121	36.1	2.3
3	*5240.00	126.3 PK			2.02 H	121	124.3	2.0
4	*5240.00	116.6 AV			2.02 H	121	114.6	2.0
5	5350.00	50.9 PK	74.0	-23.1	2.02 H	121	49.0	1.9
6	5350.00	38.0 AV	54.0	-16.0	2.02 H	121	36.1	1.9
7	#10480.00	58.2 PK	68.2	-10.0	2.69 H	318	46.3	11.9
8	15720.00	62.0 PK	74.0	-12.0	1.49 H	274	50.2	11.8
9	15720.00	48.5 AV	54.0	-5.5	1.49 H	274	36.7	11.8

Antenna Polarity & Test Distance : Vertical at 3 m

No	Frequency (MHz)	Emission Level (dBuV/m)	Limit (dBuV/m)	Margin (dB)	Antenna Height (m)	Table Angle (Degree)	Raw Value (dBuV)	Correction Factor (dB/m)
1	5150.00	53.2 PK	74.0	-20.8	1.59 V	112	50.9	2.3
2	5150.00	38.9 AV	54.0	-15.1	1.59 V	112	36.6	2.3
3	*5240.00	115.6 PK			1.59 V	112	113.6	2.0
4	*5240.00	106.4 AV			1.59 V	112	104.4	2.0
5	5350.00	50.8 PK	74.0	-23.2	1.59 V	112	48.9	1.9
6	5350.00	37.6 AV	54.0	-16.4	1.59 V	112	35.7	1.9
7	#10480.00	59.5 PK	68.2	-8.7	2.67 V	336	47.6	11.9
8	15720.00	63.3 PK	74.0	-10.7	1.36 V	272	51.5	11.8
9	15720.00	50.4 AV	54.0	-3.6	1.36 V	272	38.6	11.8

Remarks:

1. Emission Level(dBuV/m) = Raw Value(dBuV) + Correction Factor(dB/m)
2. Correction Factor(dB/m) = Antenna Factor(dB/m) + Cable Factor(dB) – Pre-Amplifier Factor(dB)
3. Margin value = Emission Level – Limit value
4. The other emission levels were very low against the limit.
5. " * ": Fundamental frequency.
6. " # ": The radiated frequency is out of the restricted band.

RF Mode	TX 20MHz Preamble 802.11ax (RU26)	Channel	CH 52 : 5260 MHz
Frequency Range	1GHz ~ 40GHz	Detector Function	Peak (PK) Average (AV)

Antenna Polarity & Test Distance : Horizontal at 3 m

No	Frequency (MHz)	Emission Level (dBuV/m)	Limit (dBuV/m)	Margin (dB)	Antenna Height (m)	Table Angle (Degree)	Raw Value (dBuV)	Correction Factor (dB/m)
1	5150.00	51.6 PK	74.0	-22.4	2.02 H	123	49.3	2.3
2	5150.00	38.1 AV	54.0	-15.9	2.02 H	123	35.8	2.3
3	*5260.00	125.2 PK			2.02 H	123	123.2	2.0
4	*5260.00	115.8 AV			2.02 H	123	113.8	2.0
5	5350.00	50.9 PK	74.0	-23.1	2.02 H	123	49.0	1.9
6	5350.00	38.2 AV	54.0	-15.8	2.02 H	123	36.3	1.9
7	#10520.00	57.8 PK	68.2	-10.4	2.65 H	326	45.8	12.0
8	15780.00	62.6 PK	74.0	-11.4	1.49 H	270	51.1	11.5
9	15780.00	49.0 AV	54.0	-5.0	1.49 H	270	37.5	11.5

Antenna Polarity & Test Distance : Vertical at 3 m

No	Frequency (MHz)	Emission Level (dBuV/m)	Limit (dBuV/m)	Margin (dB)	Antenna Height (m)	Table Angle (Degree)	Raw Value (dBuV)	Correction Factor (dB/m)
1	5150.00	53.4 PK	74.0	-20.6	1.53 V	121	51.1	2.3
2	5150.00	39.0 AV	54.0	-15.0	1.53 V	121	36.7	2.3
3	*5260.00	116.1 PK			1.53 V	121	114.1	2.0
4	*5260.00	106.9 AV			1.53 V	121	104.9	2.0
5	5350.00	50.3 PK	74.0	-23.7	1.53 V	121	48.4	1.9
6	5350.00	37.4 AV	54.0	-16.6	1.53 V	121	35.5	1.9
7	#10520.00	59.5 PK	68.2	-8.7	2.59 V	324	47.5	12.0
8	15780.00	63.8 PK	74.0	-10.2	1.32 V	278	52.3	11.5
9	15780.00	50.7 AV	54.0	-3.3	1.32 V	278	39.2	11.5

Remarks:

1. Emission Level(dBuV/m) = Raw Value(dBuV) + Correction Factor(dB/m)
2. Correction Factor(dB/m) = Antenna Factor(dB/m) + Cable Factor(dB) – Pre-Amplifier Factor(dB)
3. Margin value = Emission Level – Limit value
4. The other emission levels were very low against the limit.
5. " * ": Fundamental frequency.
6. " # ": The radiated frequency is out of the restricted band.

RF Mode	TX 20MHz Preamble 802.11ax (RU26)	Channel	CH 60 : 5300 MHz
Frequency Range	1GHz ~ 40GHz	Detector Function	Peak (PK) Average (AV)

Antenna Polarity & Test Distance : Horizontal at 3 m

No	Frequency (MHz)	Emission Level (dBuV/m)	Limit (dBuV/m)	Margin (dB)	Antenna Height (m)	Table Angle (Degree)	Raw Value (dBuV)	Correction Factor (dB/m)
1	*5300.00	126.0 PK			2.03 H	129	124.3	1.7
2	*5300.00	116.4 AV			2.03 H	129	114.7	1.7
3	5350.00	53.8 PK	74.0	-20.2	2.03 H	129	51.9	1.9
4	5350.00	43.3 AV	54.0	-10.7	2.03 H	129	41.4	1.9
5	10600.00	57.6 PK	74.0	-16.4	2.69 H	329	45.7	11.9
6	10600.00	47.3 AV	54.0	-6.7	2.69 H	329	35.4	11.9
7	15900.00	62.0 PK	74.0	-12.0	1.54 H	270	50.7	11.3
8	15900.00	48.8 AV	54.0	-5.2	1.54 H	270	37.5	11.3

Antenna Polarity & Test Distance : Vertical at 3 m

No	Frequency (MHz)	Emission Level (dBuV/m)	Limit (dBuV/m)	Margin (dB)	Antenna Height (m)	Table Angle (Degree)	Raw Value (dBuV)	Correction Factor (dB/m)
1	*5300.00	115.9 PK			1.56 V	117	114.2	1.7
2	*5300.00	106.9 AV			1.56 V	117	105.2	1.7
3	5350.00	52.6 PK	74.0	-21.4	1.56 V	117	50.7	1.9
4	5350.00	41.5 AV	54.0	-12.5	1.56 V	117	39.6	1.9
5	10600.00	59.3 PK	74.0	-14.7	2.62 V	316	47.4	11.9
6	10600.00	48.1 AV	54.0	-5.9	2.62 V	316	36.2	11.9
7	15900.00	63.4 PK	74.0	-10.6	1.35 V	265	52.1	11.3
8	15900.00	50.2 AV	54.0	-3.8	1.35 V	265	38.9	11.3

Remarks:

1. Emission Level(dBuV/m) = Raw Value(dBuV) + Correction Factor(dB/m)
2. Correction Factor(dB/m) = Antenna Factor(dB/m) + Cable Factor(dB) – Pre-Amplifier Factor(dB)
3. Margin value = Emission Level – Limit value
4. The other emission levels were very low against the limit.
5. " * ": Fundamental frequency.

RF Mode	TX 20MHz Preamble 802.11ax (RU26)	Channel	CH 64 : 5320 MHz
Frequency Range	1GHz ~ 40GHz	Detector Function	Peak (PK) Average (AV)

Antenna Polarity & Test Distance : Horizontal at 3 m

No	Frequency (MHz)	Emission Level (dBuV/m)	Limit (dBuV/m)	Margin (dB)	Antenna Height (m)	Table Angle (Degree)	Raw Value (dBuV)	Correction Factor (dB/m)
1	*5320.00	124.7 PK			2.02 H	123	122.9	1.8
2	*5320.00	116.3 AV			2.02 H	123	114.5	1.8
3	5353.40	60.9 PK	74.0	-13.1	2.02 H	123	59.0	1.9
4	5353.40	47.2 AV	54.0	-6.8	2.02 H	123	45.3	1.9
5	5361.10	72.5 PK	74.0	-1.5	2.02 H	123	70.5	2.0
6	5361.10	46.2 AV	54.0	-7.8	2.02 H	123	44.2	2.0
7	10640.00	58.0 PK	74.0	-16.0	2.64 H	308	46.2	11.8
8	10640.00	47.8 AV	54.0	-6.2	2.64 H	308	36.0	11.8
9	15960.00	61.9 PK	74.0	-12.1	1.47 H	275	50.3	11.6
10	15960.00	48.4 AV	54.0	-5.6	1.47 H	275	36.8	11.6

Antenna Polarity & Test Distance : Vertical at 3 m

No	Frequency (MHz)	Emission Level (dBuV/m)	Limit (dBuV/m)	Margin (dB)	Antenna Height (m)	Table Angle (Degree)	Raw Value (dBuV)	Correction Factor (dB/m)
1	*5320.00	115.3 PK			1.59 V	120	113.5	1.8
2	*5320.00	106.4 AV			1.59 V	120	104.6	1.8
3	5360.57	54.9 PK	74.0	-19.1	1.59 V	120	52.9	2.0
4	5360.57	38.8 AV	54.0	-15.2	1.59 V	120	36.8	2.0
5	5367.84	48.3 PK	74.0	-25.7	1.59 V	120	46.3	2.0
6	5367.84	40.0 AV	54.0	-14.0	1.59 V	120	38.0	2.0
7	10640.00	59.8 PK	74.0	-14.2	2.66 V	333	48.0	11.8
8	10640.00	48.7 AV	54.0	-5.3	2.66 V	333	36.9	11.8
9	15960.00	63.6 PK	74.0	-10.4	1.34 V	277	52.0	11.6
10	15960.00	50.4 AV	54.0	-3.6	1.34 V	277	38.8	11.6

Remarks:

1. Emission Level(dBuV/m) = Raw Value(dBuV) + Correction Factor(dB/m)
2. Correction Factor(dB/m) = Antenna Factor(dB/m) + Cable Factor(dB) – Pre-Amplifier Factor(dB)
3. Margin value = Emission Level – Limit value
4. The other emission levels were very low against the limit.
5. " * ": Fundamental frequency.

RF Mode	TX 20MHz Preamble 802.11ax (RU26)	Channel	CH 100 : 5500 MHz
Frequency Range	1GHz ~ 40GHz	Detector Function	Peak (PK) Average (AV)

Antenna Polarity & Test Distance : Horizontal at 3 m

No	Frequency (MHz)	Emission Level (dBuV/m)	Limit (dBuV/m)	Margin (dB)	Antenna Height (m)	Table Angle (Degree)	Raw Value (dBuV)	Correction Factor (dB/m)
1	5451.80	57.9 PK	74.0	-16.1	1.98 H	103	55.8	2.1
2	5451.80	47.5 AV	54.0	-6.5	1.98 H	103	45.4	2.1
3	5457.80	63.4 PK	74.0	-10.6	1.98 H	103	61.3	2.1
4	5457.80	41.9 AV	54.0	-12.1	1.98 H	103	39.8	2.1
5	#5467.50	66.2 PK	68.2	-2.0	1.98 H	103	64.0	2.2
6	*5500.00	123.8 PK			1.98 H	103	121.7	2.1
7	*5500.00	113.7 AV			1.98 H	103	111.6	2.1
8	11000.00	57.6 PK	74.0	-16.4	2.64 H	301	45.2	12.4
9	11000.00	47.5 AV	54.0	-6.5	2.64 H	301	35.1	12.4
10	#16500.00	61.8 PK	68.2	-6.4	1.49 H	295	48.1	13.7

Antenna Polarity & Test Distance : Vertical at 3 m

No	Frequency (MHz)	Emission Level (dBuV/m)	Limit (dBuV/m)	Margin (dB)	Antenna Height (m)	Table Angle (Degree)	Raw Value (dBuV)	Correction Factor (dB/m)
1	5457.85	50.5 PK	74.0	-23.5	1.53 V	115	48.4	2.1
2	5457.85	38.2 AV	54.0	-15.8	1.53 V	115	36.1	2.1
3	#5468.00	51.5 PK	68.2	-16.7	1.53 V	115	49.3	2.2
4	*5500.00	113.1 PK			1.53 V	115	111.0	2.1
5	*5500.00	103.4 AV			1.53 V	115	101.3	2.1
6	11000.00	59.9 PK	74.0	-14.1	2.69 V	314	47.5	12.4
7	11000.00	48.4 AV	54.0	-5.6	2.69 V	314	36.0	12.4
8	#16500.00	62.9 PK	68.2	-5.3	1.40 V	263	49.2	13.7

Remarks:

1. Emission Level(dBuV/m) = Raw Value(dBuV) + Correction Factor(dB/m)
2. Correction Factor(dB/m) = Antenna Factor(dB/m) + Cable Factor(dB) – Pre-Amplifier Factor(dB)
3. Margin value = Emission Level – Limit value
4. The other emission levels were very low against the limit.
5. " * ": Fundamental frequency.
6. " # ": The radiated frequency is out of the restricted band.

RF Mode	TX 20MHz Preamble 802.11ax (RU26)	Channel	CH 116 : 5580 MHz
Frequency Range	1GHz ~ 40GHz	Detector Function	Peak (PK) Average (AV)

Antenna Polarity & Test Distance : Horizontal at 3 m

No	Frequency (MHz)	Emission Level (dBuV/m)	Limit (dBuV/m)	Margin (dB)	Antenna Height (m)	Table Angle (Degree)	Raw Value (dBuV)	Correction Factor (dB/m)
1	*5580.00	126.3 PK			2.04 H	122	124.2	2.1
2	*5580.00	116.6 AV			2.04 H	122	114.5	2.1
3	11160.00	58.0 PK	74.0	-16.0	2.71 H	324	46.0	12.0
4	11160.00	47.6 AV	54.0	-6.4	2.71 H	324	35.6	12.0
5	#16740.00	62.3 PK	68.2	-5.9	1.47 H	287	47.0	15.3

Antenna Polarity & Test Distance : Vertical at 3 m

No	Frequency (MHz)	Emission Level (dBuV/m)	Limit (dBuV/m)	Margin (dB)	Antenna Height (m)	Table Angle (Degree)	Raw Value (dBuV)	Correction Factor (dB/m)
1	*5580.00	116.5 PK			1.53 V	120	114.4	2.1
2	*5580.00	107.3 AV			1.53 V	120	105.2	2.1
3	11160.00	59.5 PK	74.0	-14.5	2.62 V	309	47.5	12.0
4	11160.00	47.9 AV	54.0	-6.1	2.62 V	309	35.9	12.0
5	#16740.00	62.9 PK	68.2	-5.3	1.35 V	280	47.6	15.3

Remarks:

1. Emission Level(dBuV/m) = Raw Value(dBuV) + Correction Factor(dB/m)
2. Correction Factor(dB/m) = Antenna Factor(dB/m) + Cable Factor(dB) – Pre-Amplifier Factor(dB)
3. Margin value = Emission Level – Limit value
4. The other emission levels were very low against the limit.
5. " * " : Fundamental frequency.
6. " # " : The radiated frequency is out of the restricted band.

RF Mode	TX 20MHz Preamble 802.11ax (RU26)	Channel	CH 140 : 5700 MHz
Frequency Range	1GHz ~ 40GHz	Detector Function	Peak (PK) Average (AV)

Antenna Polarity & Test Distance : Horizontal at 3 m

No	Frequency (MHz)	Emission Level (dBuV/m)	Limit (dBuV/m)	Margin (dB)	Antenna Height (m)	Table Angle (Degree)	Raw Value (dBuV)	Correction Factor (dB/m)
1	*5700.00	125.2 PK			2.07 H	111	122.9	2.3
2	*5700.00	113.1 AV			2.07 H	111	110.8	2.3
3	#5725.43	66.6 PK	68.2	-1.6	2.07 H	111	64.2	2.4
4	11400.00	58.5 PK	74.0	-15.5	2.64 H	321	46.0	12.5
5	11400.00	48.0 AV	54.0	-6.0	2.64 H	321	35.5	12.5
6	#17100.00	61.9 PK	68.2	-6.3	1.53 H	296	45.1	16.8

Antenna Polarity & Test Distance : Vertical at 3 m

No	Frequency (MHz)	Emission Level (dBuV/m)	Limit (dBuV/m)	Margin (dB)	Antenna Height (m)	Table Angle (Degree)	Raw Value (dBuV)	Correction Factor (dB/m)
1	*5700.00	112.6 PK			1.56 V	126	110.3	2.3
2	*5700.00	103.8 AV			1.56 V	126	101.5	2.3
3	#5725.00	61.6 PK	68.2	-6.6	1.56 V	126	59.2	2.4
4	11400.00	60.4 PK	74.0	-13.6	2.66 V	321	47.9	12.5
5	11400.00	48.9 AV	54.0	-5.1	2.66 V	321	36.4	12.5
6	#17100.00	63.7 PK	68.2	-4.5	1.34 V	283	46.9	16.8

Remarks:

1. Emission Level(dBuV/m) = Raw Value(dBuV) + Correction Factor(dB/m)
2. Correction Factor(dB/m) = Antenna Factor(dB/m) + Cable Factor(dB) – Pre-Amplifier Factor(dB)
3. Margin value = Emission Level – Limit value
4. The other emission levels were very low against the limit.
5. " * ": Fundamental frequency.
6. " # ": The radiated frequency is out of the restricted band.

RF Mode	TX 20MHz Preamble 802.11ax (RU26)	Channel	CH 144 : 5720 MHz
Frequency Range	1GHz ~ 40GHz	Detector Function	Peak (PK) Average (AV)

Antenna Polarity & Test Distance : Horizontal at 3 m

No	Frequency (MHz)	Emission Level (dBuV/m)	Limit (dBuV/m)	Margin (dB)	Antenna Height (m)	Table Angle (Degree)	Raw Value (dBuV)	Correction Factor (dB/m)
1	5460.00	51.1 PK	74.0	-22.9	2.06 H	115	49.0	2.1
2	5460.00	38.6 AV	54.0	-15.4	2.06 H	115	36.5	2.1
3	#5470.00	51.8 PK	68.2	-16.4	2.06 H	115	49.6	2.2
4	*5720.00	126.2 PK			2.06 H	115	123.8	2.4
5	*5720.00	116.7 AV			2.06 H	115	114.3	2.4
6	#5850.00	51.6 PK	68.2	-16.6	2.06 H	115	48.9	2.7
7	11440.00	57.5 PK	74.0	-16.5	2.71 H	318	45.1	12.4
8	11440.00	47.4 AV	54.0	-6.6	2.71 H	318	35.0	12.4
9	#17160.00	62.2 PK	68.2	-6.0	1.49 H	267	45.6	16.6

Antenna Polarity & Test Distance : Vertical at 3 m

No	Frequency (MHz)	Emission Level (dBuV/m)	Limit (dBuV/m)	Margin (dB)	Antenna Height (m)	Table Angle (Degree)	Raw Value (dBuV)	Correction Factor (dB/m)
1	5460.00	51.3 PK	74.0	-22.7	1.55 V	129	49.2	2.1
2	5460.00	38.4 AV	54.0	-15.6	1.55 V	129	36.3	2.1
3	#5470.00	52.3 PK	68.2	-15.9	1.55 V	129	50.1	2.2
4	*5720.00	116.4 PK			1.55 V	129	114.0	2.4
5	*5720.00	107.3 AV			1.55 V	129	104.9	2.4
6	#5850.00	51.5 PK	68.2	-16.7	1.55 V	129	48.8	2.7
7	11440.00	59.8 PK	74.0	-14.2	2.60 V	325	47.4	12.4
8	11440.00	48.5 AV	54.0	-5.5	2.60 V	325	36.1	12.4
9	#17160.00	63.2 PK	68.2	-5.0	1.43 V	262	46.6	16.6

Remarks:

1. Emission Level(dBuV/m) = Raw Value(dBuV) + Correction Factor(dB/m)
2. Correction Factor(dB/m) = Antenna Factor(dB/m) + Cable Factor(dB) – Pre-Amplifier Factor(dB)
3. Margin value = Emission Level – Limit value
4. The other emission levels were very low against the limit.
5. " * ": Fundamental frequency.
6. " # ": The radiated frequency is out of the restricted band.

RF Mode	TX 20MHz Preamble 802.11ax (RU26)	Channel	CH 149 : 5745 MHz
Frequency Range	1GHz ~ 40GHz	Detector Function	Peak (PK) Average (AV)

Antenna Polarity & Test Distance : Horizontal at 3 m

No	Frequency (MHz)	Emission Level (dBuV/m)	Limit (dBuV/m)	Margin (dB)	Antenna Height (m)	Table Angle (Degree)	Raw Value (dBuV)	Correction Factor (dB/m)
1	#5577.87	53.2 PK	68.2	-15.0	1.83 H	127	51.1	2.1
2	*5745.00	126.3 PK			1.83 H	127	123.9	2.4
3	*5745.00	116.3 AV			1.83 H	127	113.9	2.4
4	#5956.68	52.2 PK	68.2	-16.0	1.83 H	127	49.3	2.9
5	11490.00	59.5 PK	74.0	-14.5	2.65 H	320	46.9	12.6
6	11490.00	49.8 AV	54.0	-4.2	2.65 H	320	37.2	12.6
7	#17235.00	63.8 PK	68.2	-4.4	1.51 H	264	47.0	16.8

Antenna Polarity & Test Distance : Vertical at 3 m

No	Frequency (MHz)	Emission Level (dBuV/m)	Limit (dBuV/m)	Margin (dB)	Antenna Height (m)	Table Angle (Degree)	Raw Value (dBuV)	Correction Factor (dB/m)
1	#5580.97	51.4 PK	68.2	-16.8	1.94 V	118	49.3	2.1
2	*5745.00	115.1 PK			1.94 V	118	112.7	2.4
3	*5745.00	105.3 AV			1.94 V	118	102.9	2.4
4	#5979.23	52.5 PK	68.2	-15.7	1.94 V	118	49.6	2.9
5	11490.00	59.1 PK	74.0	-14.9	2.67 V	330	46.5	12.6
6	11490.00	49.3 AV	54.0	-4.7	2.67 V	330	36.7	12.6
7	#17235.00	64.9 PK	68.2	-3.3	1.39 V	285	48.1	16.8

Remarks:

1. Emission Level(dBuV/m) = Raw Value(dBuV) + Correction Factor(dB/m)
2. Correction Factor(dB/m) = Antenna Factor(dB/m) + Cable Factor(dB) – Pre-Amplifier Factor(dB)
3. Margin value = Emission Level – Limit value
4. The other emission levels were very low against the limit.
5. " * ": Fundamental frequency.
6. " # ": The radiated frequency is out of the restricted band.

RF Mode	TX 20MHz Preamble 802.11ax (RU26)	Channel	CH 157 : 5785 MHz
Frequency Range	1GHz ~ 40GHz	Detector Function	Peak (PK) Average (AV)

Antenna Polarity & Test Distance : Horizontal at 3 m

No	Frequency (MHz)	Emission Level (dBuV/m)	Limit (dBuV/m)	Margin (dB)	Antenna Height (m)	Table Angle (Degree)	Raw Value (dBuV)	Correction Factor (dB/m)
1	#5552.33	53.7 PK	68.2	-14.5	1.91 H	108	51.6	2.1
2	*5785.00	127.1 PK			1.91 H	108	124.5	2.6
3	*5785.00	117.0 AV			1.91 H	108	114.4	2.6
4	#5952.25	54.6 PK	68.2	-13.6	1.91 H	108	51.7	2.9
5	11570.00	59.4 PK	74.0	-14.6	2.68 H	310	46.8	12.6
6	11570.00	49.7 AV	54.0	-4.3	2.68 H	310	37.1	12.6
7	#17355.00	63.6 PK	68.2	-4.6	1.46 H	278	45.9	17.7

Antenna Polarity & Test Distance : Vertical at 3 m

No	Frequency (MHz)	Emission Level (dBuV/m)	Limit (dBuV/m)	Margin (dB)	Antenna Height (m)	Table Angle (Degree)	Raw Value (dBuV)	Correction Factor (dB/m)
1	#5639.77	51.7 PK	68.2	-16.5	1.90 V	110	49.4	2.3
2	*5785.00	115.8 PK			1.90 V	110	113.2	2.6
3	*5785.00	106.1 AV			1.90 V	110	103.5	2.6
4	#6013.66	51.6 PK	68.2	-16.6	1.90 V	110	48.7	2.9
5	11570.00	60.9 PK	74.0	-13.1	2.69 V	320	48.3	12.6
6	11570.00	50.5 AV	54.0	-3.5	2.69 V	320	37.9	12.6
7	#17355.00	65.1 PK	68.2	-3.1	1.40 V	280	47.4	17.7

Remarks:

1. Emission Level(dBuV/m) = Raw Value(dBuV) + Correction Factor(dB/m)
2. Correction Factor(dB/m) = Antenna Factor(dB/m) + Cable Factor(dB) – Pre-Amplifier Factor(dB)
3. Margin value = Emission Level – Limit value
4. The other emission levels were very low against the limit.
5. " * ": Fundamental frequency.
6. " # ": The radiated frequency is out of the restricted band.

RF Mode	TX 20MHz Preamble 802.11ax (RU26)	Channel	CH 165 : 5825 MHz
Frequency Range	1GHz ~ 40GHz	Detector Function	Peak (PK) Average (AV)

Antenna Polarity & Test Distance : Horizontal at 3 m

No	Frequency (MHz)	Emission Level (dBuV/m)	Limit (dBuV/m)	Margin (dB)	Antenna Height (m)	Table Angle (Degree)	Raw Value (dBuV)	Correction Factor (dB/m)
1	#5616.62	54.1 PK	68.2	-14.1	1.95 H	112	52.0	2.1
2	*5825.00	126.6 PK			1.95 H	112	124.0	2.6
3	*5825.00	116.5 AV			1.95 H	112	113.9	2.6
4	#5925.27	52.8 PK	68.2	-15.4	1.95 H	112	49.9	2.9
5	11650.00	59.6 PK	74.0	-14.4	2.68 H	315	47.4	12.2
6	11650.00	49.7 AV	54.0	-4.3	2.68 H	315	37.5	12.2
7	#17475.00	63.6 PK	68.2	-4.6	1.45 H	272	44.9	18.7

Antenna Polarity & Test Distance : Vertical at 3 m

No	Frequency (MHz)	Emission Level (dBuV/m)	Limit (dBuV/m)	Margin (dB)	Antenna Height (m)	Table Angle (Degree)	Raw Value (dBuV)	Correction Factor (dB/m)
1	#5559.83	52.2 PK	68.2	-16.0	1.92 V	107	50.1	2.1
2	*5825.00	115.2 PK			1.92 V	107	112.6	2.6
3	*5825.00	105.3 AV			1.92 V	107	102.7	2.6
4	#6020.23	51.9 PK	68.2	-16.3	1.92 V	107	48.9	3.0
5	11650.00	58.1 PK	74.0	-15.9	2.72 V	324	45.9	12.2
6	11650.00	48.4 AV	54.0	-5.6	2.72 V	324	36.2	12.2
7	#17475.00	64.6 PK	68.2	-3.6	1.44 V	289	45.9	18.7

Remarks:

1. Emission Level(dBuV/m) = Raw Value(dBuV) + Correction Factor(dB/m)
2. Correction Factor(dB/m) = Antenna Factor(dB/m) + Cable Factor(dB) – Pre-Amplifier Factor(dB)
3. Margin value = Emission Level – Limit value
4. The other emission levels were very low against the limit.
5. " * ": Fundamental frequency.
6. " # ": The radiated frequency is out of the restricted band.

RF Mode	TX 20MHz Preamble 802.11ax (RU52)	Channel	CH 36 : 5180 MHz
Frequency Range	1GHz ~ 40GHz	Detector Function	Peak (PK) Average (AV)

Antenna Polarity & Test Distance : Horizontal at 3 m

No	Frequency (MHz)	Emission Level (dBuV/m)	Limit (dBuV/m)	Margin (dB)	Antenna Height (m)	Table Angle (Degree)	Raw Value (dBuV)	Correction Factor (dB/m)
1	5145.17	67.5 PK	74.0	-6.5	2.16 H	118	65.2	2.3
2	5145.17	47.3 AV	54.0	-6.7	2.16 H	118	45.0	2.3
3	*5180.00	122.3 PK			2.16 H	118	120.1	2.2
4	*5180.00	112.0 AV			2.16 H	118	109.8	2.2
5	#10360.00	55.5 PK	68.2	-12.7	1.29 H	337	43.7	11.8
6	15540.00	62.7 PK	74.0	-11.3	1.48 H	287	50.9	11.8
7	15540.00	48.6 AV	54.0	-5.4	1.48 H	287	36.8	11.8

Antenna Polarity & Test Distance : Vertical at 3 m

No	Frequency (MHz)	Emission Level (dBuV/m)	Limit (dBuV/m)	Margin (dB)	Antenna Height (m)	Table Angle (Degree)	Raw Value (dBuV)	Correction Factor (dB/m)
1	5146.30	67.5 PK	74.0	-6.5	1.26 V	125	65.2	2.3
2	5146.30	43.0 AV	54.0	-11.0	1.26 V	125	40.7	2.3
3	*5180.00	118.3 PK			1.26 V	125	116.1	2.2
4	*5180.00	105.9 AV			1.26 V	125	103.7	2.2
5	#10360.00	55.7 PK	68.2	-12.5	1.54 V	307	43.9	11.8
6	15540.00	61.4 PK	74.0	-12.6	1.64 V	294	49.6	11.8
7	15540.00	47.5 AV	54.0	-6.5	1.64 V	294	35.7	11.8

Remarks:

1. Emission Level(dBuV/m) = Raw Value(dBuV) + Correction Factor(dB/m)
2. Correction Factor(dB/m) = Antenna Factor(dB/m) + Cable Factor(dB) – Pre-Amplifier Factor(dB)
3. Margin value = Emission Level – Limit value
4. The other emission levels were very low against the limit.
5. " * ": Fundamental frequency.
6. " # ": The radiated frequency is out of the restricted band.

RF Mode	TX 20MHz Preamble 802.11ax (RU52)	Channel	CH 40 : 5200 MHz
Frequency Range	1GHz ~ 40GHz	Detector Function	Peak (PK) Average (AV)

Antenna Polarity & Test Distance : Horizontal at 3 m

No	Frequency (MHz)	Emission Level (dBuV/m)	Limit (dBuV/m)	Margin (dB)	Antenna Height (m)	Table Angle (Degree)	Raw Value (dBuV)	Correction Factor (dB/m)
1	5150.00	54.0 PK	74.0	-20.0	2.17 H	111	51.7	2.3
2	5150.00	43.5 AV	54.0	-10.5	2.17 H	111	41.2	2.3
3	*5200.00	122.2 PK			2.17 H	111	120.1	2.1
4	*5200.00	111.9 AV			2.17 H	111	109.8	2.1
5	#10400.00	55.0 PK	68.2	-13.2	1.30 H	335	43.0	12.0
6	15600.00	62.9 PK	74.0	-11.1	1.52 H	277	51.4	11.5
7	15600.00	48.7 AV	54.0	-5.3	1.52 H	277	37.2	11.5

Antenna Polarity & Test Distance : Vertical at 3 m

No	Frequency (MHz)	Emission Level (dBuV/m)	Limit (dBuV/m)	Margin (dB)	Antenna Height (m)	Table Angle (Degree)	Raw Value (dBuV)	Correction Factor (dB/m)
1	5150.00	52.5 PK	74.0	-21.5	1.31 V	130	50.2	2.3
2	5150.00	42.0 AV	54.0	-12.0	1.31 V	130	39.7	2.3
3	*5200.00	118.7 PK			1.31 V	130	116.6	2.1
4	*5200.00	106.4 AV			1.31 V	130	104.3	2.1
5	#10400.00	55.7 PK	68.2	-12.5	1.57 V	296	43.7	12.0
6	15600.00	61.1 PK	74.0	-12.9	1.61 V	309	49.6	11.5
7	15600.00	47.1 AV	54.0	-6.9	1.61 V	309	35.6	11.5

Remarks:

1. Emission Level(dBuV/m) = Raw Value(dBuV) + Correction Factor(dB/m)
2. Correction Factor(dB/m) = Antenna Factor(dB/m) + Cable Factor(dB) – Pre-Amplifier Factor(dB)
3. Margin value = Emission Level – Limit value
4. The other emission levels were very low against the limit.
5. " * ": Fundamental frequency.
6. " # ": The radiated frequency is out of the restricted band.

RF Mode	TX 20MHz Preamble 802.11ax (RU52)	Channel	CH 48 : 5240 MHz
Frequency Range	1GHz ~ 40GHz	Detector Function	Peak (PK) Average (AV)

Antenna Polarity & Test Distance : Horizontal at 3 m

No	Frequency (MHz)	Emission Level (dBuV/m)	Limit (dBuV/m)	Margin (dB)	Antenna Height (m)	Table Angle (Degree)	Raw Value (dBuV)	Correction Factor (dB/m)
1	5150.00	52.5 PK	74.0	-21.5	2.15 H	108	50.2	2.3
2	5150.00	38.7 AV	54.0	-15.3	2.15 H	108	36.4	2.3
3	*5240.00	122.5 PK			2.15 H	108	120.5	2.0
4	*5240.00	112.4 AV			2.15 H	108	110.4	2.0
5	5350.00	50.5 PK	74.0	-23.5	2.15 H	108	48.6	1.9
6	5350.00	37.7 AV	54.0	-16.3	2.15 H	108	35.8	1.9
7	#10480.00	55.9 PK	68.2	-12.3	1.29 H	334	44.0	11.9
8	15720.00	62.8 PK	74.0	-11.2	1.45 H	290	51.0	11.8
9	15720.00	48.8 AV	54.0	-5.2	1.45 H	290	37.0	11.8

Antenna Polarity & Test Distance : Vertical at 3 m

No	Frequency (MHz)	Emission Level (dBuV/m)	Limit (dBuV/m)	Margin (dB)	Antenna Height (m)	Table Angle (Degree)	Raw Value (dBuV)	Correction Factor (dB/m)
1	5150.00	52.8 PK	74.0	-21.2	1.24 V	114	50.5	2.3
2	5150.00	38.4 AV	54.0	-15.6	1.24 V	114	36.1	2.3
3	*5240.00	118.3 PK			1.24 V	114	116.3	2.0
4	*5240.00	105.8 AV			1.24 V	114	103.8	2.0
5	5350.00	50.5 PK	74.0	-23.5	1.24 V	114	48.6	1.9
6	5350.00	37.1 AV	54.0	-16.9	1.24 V	114	35.2	1.9
7	#10480.00	55.8 PK	68.2	-12.4	1.57 V	305	43.9	11.9
8	15720.00	61.2 PK	74.0	-12.8	1.62 V	282	49.4	11.8
9	15720.00	47.1 AV	54.0	-6.9	1.62 V	282	35.3	11.8

Remarks:

1. Emission Level(dBuV/m) = Raw Value(dBuV) + Correction Factor(dB/m)
2. Correction Factor(dB/m) = Antenna Factor(dB/m) + Cable Factor(dB) – Pre-Amplifier Factor(dB)
3. Margin value = Emission Level – Limit value
4. The other emission levels were very low against the limit.
5. " * ": Fundamental frequency.
6. " # ": The radiated frequency is out of the restricted band.

RF Mode	TX 20MHz Preamble 802.11ax (RU52)	Channel	CH 52 : 5260 MHz
Frequency Range	1GHz ~ 40GHz	Detector Function	Peak (PK) Average (AV)

Antenna Polarity & Test Distance : Horizontal at 3 m

No	Frequency (MHz)	Emission Level (dBuV/m)	Limit (dBuV/m)	Margin (dB)	Antenna Height (m)	Table Angle (Degree)	Raw Value (dBuV)	Correction Factor (dB/m)
1	5150.00	52.1 PK	74.0	-21.9	2.14 H	118	49.8	2.3
2	5150.00	38.8 AV	54.0	-15.2	2.14 H	118	36.5	2.3
3	*5260.00	122.7 PK			2.14 H	118	120.7	2.0
4	*5260.00	112.3 AV			2.14 H	118	110.3	2.0
5	5350.00	51.0 PK	74.0	-23.0	2.14 H	118	49.1	1.9
6	5350.00	38.3 AV	54.0	-15.7	2.14 H	118	36.4	1.9
7	#10520.00	55.0 PK	68.2	-13.2	1.30 H	338	43.0	12.0
8	15780.00	62.2 PK	74.0	-11.8	1.45 H	299	50.7	11.5
9	15780.00	48.2 AV	54.0	-5.8	1.45 H	299	36.7	11.5

Antenna Polarity & Test Distance : Vertical at 3 m

No	Frequency (MHz)	Emission Level (dBuV/m)	Limit (dBuV/m)	Margin (dB)	Antenna Height (m)	Table Angle (Degree)	Raw Value (dBuV)	Correction Factor (dB/m)
1	5150.00	53.1 PK	74.0	-20.9	1.23 V	136	50.8	2.3
2	5150.00	38.6 AV	54.0	-15.4	1.23 V	136	36.3	2.3
3	*5260.00	118.2 PK			1.23 V	136	116.2	2.0
4	*5260.00	106.0 AV			1.23 V	136	104.0	2.0
5	5350.00	51.5 PK	74.0	-22.5	1.23 V	136	49.6	1.9
6	5350.00	38.0 AV	54.0	-16.0	1.23 V	136	36.1	1.9
7	#10520.00	55.7 PK	68.2	-12.5	1.50 V	313	43.7	12.0
8	15780.00	60.8 PK	74.0	-13.2	1.68 V	292	49.3	11.5
9	15780.00	47.2 AV	54.0	-6.8	1.68 V	292	35.7	11.5

Remarks:

1. Emission Level(dBuV/m) = Raw Value(dBuV) + Correction Factor(dB/m)
2. Correction Factor(dB/m) = Antenna Factor(dB/m) + Cable Factor(dB) – Pre-Amplifier Factor(dB)
3. Margin value = Emission Level – Limit value
4. The other emission levels were very low against the limit.
5. " * ": Fundamental frequency.
6. " # ": The radiated frequency is out of the restricted band.

RF Mode	TX 20MHz Preamble 802.11ax (RU52)	Channel	CH 60 : 5300 MHz
Frequency Range	1GHz ~ 40GHz	Detector Function	Peak (PK) Average (AV)

Antenna Polarity & Test Distance : Horizontal at 3 m

No	Frequency (MHz)	Emission Level (dBuV/m)	Limit (dBuV/m)	Margin (dB)	Antenna Height (m)	Table Angle (Degree)	Raw Value (dBuV)	Correction Factor (dB/m)
1	*5300.00	122.6 PK			2.22 H	130	120.9	1.7
2	*5300.00	112.2 AV			2.22 H	130	110.5	1.7
3	5350.00	54.5 PK	74.0	-19.5	2.22 H	130	52.6	1.9
4	5350.00	43.6 AV	54.0	-10.4	2.22 H	130	41.7	1.9
5	10600.00	55.5 PK	74.0	-18.5	1.35 H	321	43.6	11.9
6	10600.00	43.1 AV	54.0	-10.9	1.35 H	321	31.2	11.9
7	15900.00	62.5 PK	74.0	-11.5	1.54 H	279	51.2	11.3
8	15900.00	48.2 AV	54.0	-5.8	1.54 H	279	36.9	11.3

Antenna Polarity & Test Distance : Vertical at 3 m

No	Frequency (MHz)	Emission Level (dBuV/m)	Limit (dBuV/m)	Margin (dB)	Antenna Height (m)	Table Angle (Degree)	Raw Value (dBuV)	Correction Factor (dB/m)
1	*5300.00	118.3 PK			1.28 V	113	116.6	1.7
2	*5300.00	105.8 AV			1.28 V	113	104.1	1.7
3	5350.00	52.7 PK	74.0	-21.3	1.28 V	113	50.8	1.9
4	5350.00	41.9 AV	54.0	-12.1	1.28 V	113	40.0	1.9
5	10600.00	55.7 PK	74.0	-18.3	1.53 V	314	43.8	11.9
6	10600.00	44.3 AV	54.0	-9.7	1.53 V	314	32.4	11.9
7	15900.00	61.2 PK	74.0	-12.8	1.63 V	283	49.9	11.3
8	15900.00	47.6 AV	54.0	-6.4	1.63 V	283	36.3	11.3

Remarks:

1. Emission Level(dBuV/m) = Raw Value(dBuV) + Correction Factor(dB/m)
2. Correction Factor(dB/m) = Antenna Factor(dB/m) + Cable Factor(dB) – Pre-Amplifier Factor(dB)
3. Margin value = Emission Level – Limit value
4. The other emission levels were very low against the limit.
5. " * ": Fundamental frequency.

RF Mode	TX 20MHz Preamble 802.11ax (RU52)	Channel	CH 64 : 5320 MHz
Frequency Range	1GHz ~ 40GHz	Detector Function	Peak (PK) Average (AV)

Antenna Polarity & Test Distance : Horizontal at 3 m

No	Frequency (MHz)	Emission Level (dBuV/m)	Limit (dBuV/m)	Margin (dB)	Antenna Height (m)	Table Angle (Degree)	Raw Value (dBuV)	Correction Factor (dB/m)
1	*5320.00	122.1 PK			1.87 H	131	120.3	1.8
2	*5320.00	111.8 AV			1.87 H	131	110.0	1.8
3	5350.00	69.5 PK	74.0	-4.5	1.87 H	131	67.6	1.9
4	5350.00	45.6 AV	54.0	-8.4	1.87 H	131	43.7	1.9
5	10640.00	55.7 PK	74.0	-18.3	1.25 H	340	43.9	11.8
6	10640.00	43.1 AV	54.0	-10.9	1.25 H	340	31.3	11.8
7	15960.00	62.0 PK	74.0	-12.0	1.42 H	288	50.4	11.6
8	15960.00	48.1 AV	54.0	-5.9	1.42 H	288	36.5	11.6

Antenna Polarity & Test Distance : Vertical at 3 m

No	Frequency (MHz)	Emission Level (dBuV/m)	Limit (dBuV/m)	Margin (dB)	Antenna Height (m)	Table Angle (Degree)	Raw Value (dBuV)	Correction Factor (dB/m)
1	*5320.00	117.9 PK			1.29 V	120	116.1	1.8
2	*5320.00	105.5 AV			1.29 V	120	103.7	1.8
3	5356.30	65.6 PK	74.0	-8.4	1.29 V	120	63.6	2.0
4	5356.30	41.3 AV	54.0	-12.7	1.29 V	120	39.3	2.0
5	5368.70	51.2 PK	74.0	-22.8	1.29 V	120	49.2	2.0
6	5368.70	41.6 AV	54.0	-12.4	1.29 V	120	39.6	2.0
7	10640.00	55.3 PK	74.0	-18.7	1.49 V	301	43.5	11.8
8	10640.00	43.7 AV	54.0	-10.3	1.49 V	301	31.9	11.8
9	15960.00	61.6 PK	74.0	-12.4	1.62 V	285	50.0	11.6
10	15960.00	47.9 AV	54.0	-6.1	1.62 V	285	36.3	11.6

Remarks:

1. Emission Level(dBuV/m) = Raw Value(dBuV) + Correction Factor(dB/m)
2. Correction Factor(dB/m) = Antenna Factor(dB/m) + Cable Factor(dB) – Pre-Amplifier Factor(dB)
3. Margin value = Emission Level – Limit value
4. The other emission levels were very low against the limit.
5. " * ": Fundamental frequency.

RF Mode	TX 20MHz Preamble 802.11ax (RU52)	Channel	CH 100 : 5500 MHz
Frequency Range	1GHz ~ 40GHz	Detector Function	Peak (PK) Average (AV)

Antenna Polarity & Test Distance : Horizontal at 3 m

No	Frequency (MHz)	Emission Level (dBuV/m)	Limit (dBuV/m)	Margin (dB)	Antenna Height (m)	Table Angle (Degree)	Raw Value (dBuV)	Correction Factor (dB/m)
1	5454.00	58.0 PK	74.0	-16.0	1.81 H	124	55.9	2.1
2	5454.00	43.6 AV	54.0	-10.4	1.81 H	124	41.5	2.1
3	5458.00	60.4 PK	74.0	-13.6	1.81 H	124	58.3	2.1
4	5458.00	42.6 AV	54.0	-11.4	1.81 H	124	40.5	2.1
5	#5467.30	66.2 PK	68.2	-2.0	1.81 H	124	64.0	2.2
6	*5500.00	121.9 PK			1.81 H	124	119.8	2.1
7	*5500.00	111.6 AV			1.81 H	124	109.5	2.1
8	11000.00	55.7 PK	74.0	-18.3	1.34 H	343	43.3	12.4
9	11000.00	43.5 AV	54.0	-10.5	1.34 H	343	31.1	12.4
10	#16500.00	62.3 PK	68.2	-5.9	1.51 H	274	48.6	13.7

Antenna Polarity & Test Distance : Vertical at 3 m

No	Frequency (MHz)	Emission Level (dBuV/m)	Limit (dBuV/m)	Margin (dB)	Antenna Height (m)	Table Angle (Degree)	Raw Value (dBuV)	Correction Factor (dB/m)
1	5460.00	53.6 PK	74.0	-20.4	1.21 V	116	51.5	2.1
2	5460.00	40.4 AV	54.0	-13.6	1.21 V	116	38.3	2.1
3	#5466.70	65.3 PK	68.2	-2.9	1.21 V	116	63.1	2.2
4	*5500.00	119.1 PK			1.21 V	116	117.0	2.1
5	*5500.00	106.5 AV			1.21 V	116	104.4	2.1
6	11000.00	56.1 PK	74.0	-17.9	1.50 V	321	43.7	12.4
7	11000.00	44.4 AV	54.0	-9.6	1.50 V	321	32.0	12.4
8	#16500.00	60.7 PK	68.2	-7.5	1.63 V	281	47.0	13.7

Remarks:

1. Emission Level(dBuV/m) = Raw Value(dBuV) + Correction Factor(dB/m)
2. Correction Factor(dB/m) = Antenna Factor(dB/m) + Cable Factor(dB) – Pre-Amplifier Factor(dB)
3. Margin value = Emission Level – Limit value
4. The other emission levels were very low against the limit.
5. " * ": Fundamental frequency.
6. " # ": The radiated frequency is out of the restricted band.

RF Mode	TX 20MHz Preamble 802.11ax (RU52)	Channel	CH 116 : 5580 MHz
Frequency Range	1GHz ~ 40GHz	Detector Function	Peak (PK) Average (AV)

Antenna Polarity & Test Distance : Horizontal at 3 m

No	Frequency (MHz)	Emission Level (dBuV/m)	Limit (dBuV/m)	Margin (dB)	Antenna Height (m)	Table Angle (Degree)	Raw Value (dBuV)	Correction Factor (dB/m)
1	*5580.00	122.5 PK			2.18 H	125	120.4	2.1
2	*5580.00	112.1 AV			2.18 H	125	110.0	2.1
3	11160.00	55.2 PK	74.0	-18.8	1.35 H	325	43.2	12.0
4	11160.00	42.7 AV	54.0	-11.3	1.35 H	325	30.7	12.0
5	#16740.00	62.8 PK	68.2	-5.4	1.45 H	283	47.5	15.3

Antenna Polarity & Test Distance : Vertical at 3 m

No	Frequency (MHz)	Emission Level (dBuV/m)	Limit (dBuV/m)	Margin (dB)	Antenna Height (m)	Table Angle (Degree)	Raw Value (dBuV)	Correction Factor (dB/m)
1	*5580.00	118.3 PK			1.29 V	131	116.2	2.1
2	*5580.00	105.8 AV			1.29 V	131	103.7	2.1
3	11160.00	55.9 PK	74.0	-18.1	1.54 V	299	43.9	12.0
4	11160.00	44.4 AV	54.0	-9.6	1.54 V	299	32.4	12.0
5	#16740.00	61.2 PK	68.2	-7.0	1.59 V	290	45.9	15.3

Remarks:

1. Emission Level(dBuV/m) = Raw Value(dBuV) + Correction Factor(dB/m)
2. Correction Factor(dB/m) = Antenna Factor(dB/m) + Cable Factor(dB) – Pre-Amplifier Factor(dB)
3. Margin value = Emission Level – Limit value
4. The other emission levels were very low against the limit.
5. " * " : Fundamental frequency.
6. " # " : The radiated frequency is out of the restricted band.

RF Mode	TX 20MHz Preamble 802.11ax (RU52)	Channel	CH 140 : 5700 MHz
Frequency Range	1GHz ~ 40GHz	Detector Function	Peak (PK) Average (AV)

Antenna Polarity & Test Distance : Horizontal at 3 m

No	Frequency (MHz)	Emission Level (dBuV/m)	Limit (dBuV/m)	Margin (dB)	Antenna Height (m)	Table Angle (Degree)	Raw Value (dBuV)	Correction Factor (dB/m)
1	*5700.00	119.1 PK			2.03 H	118	116.8	2.3
2	*5700.00	108.8 AV			2.03 H	118	106.5	2.3
3	#5726.93	66.2 PK	68.2	-2.0	2.03 H	118	63.8	2.4
4	11400.00	55.8 PK	74.0	-18.2	1.25 H	333	43.3	12.5
5	11400.00	43.2 AV	54.0	-10.8	1.25 H	333	30.7	12.5
6	#17100.00	63.2 PK	68.2	-5.0	1.52 H	289	46.4	16.8

Antenna Polarity & Test Distance : Vertical at 3 m

No	Frequency (MHz)	Emission Level (dBuV/m)	Limit (dBuV/m)	Margin (dB)	Antenna Height (m)	Table Angle (Degree)	Raw Value (dBuV)	Correction Factor (dB/m)
1	*5700.00	114.6 PK			1.32 V	129	112.3	2.3
2	*5700.00	102.1 AV			1.32 V	129	99.8	2.3
3	#5728.00	58.9 PK	68.2	-9.3	1.32 V	129	56.4	2.5
4	11400.00	56.2 PK	74.0	-17.8	1.55 V	312	43.7	12.5
5	11400.00	44.7 AV	54.0	-9.3	1.55 V	312	32.2	12.5
6	#17100.00	61.7 PK	68.2	-6.5	1.59 V	281	44.9	16.8

Remarks:

1. Emission Level(dBuV/m) = Raw Value(dBuV) + Correction Factor(dB/m)
2. Correction Factor(dB/m) = Antenna Factor(dB/m) + Cable Factor(dB) – Pre-Amplifier Factor(dB)
3. Margin value = Emission Level – Limit value
4. The other emission levels were very low against the limit.
5. " * ": Fundamental frequency.
6. " # ": The radiated frequency is out of the restricted band.

RF Mode	TX 20MHz Preamble 802.11ax (RU52)	Channel	CH 144 : 5720 MHz
Frequency Range	1GHz ~ 40GHz	Detector Function	Peak (PK) Average (AV)

Antenna Polarity & Test Distance : Horizontal at 3 m

No	Frequency (MHz)	Emission Level (dBuV/m)	Limit (dBuV/m)	Margin (dB)	Antenna Height (m)	Table Angle (Degree)	Raw Value (dBuV)	Correction Factor (dB/m)
1	5460.00	50.8 PK	74.0	-23.2	2.20 H	120	48.7	2.1
2	5460.00	38.2 AV	54.0	-15.8	2.20 H	120	36.1	2.1
3	#5470.00	51.9 PK	68.2	-16.3	2.20 H	120	49.7	2.2
4	*5720.00	122.4 PK			2.20 H	120	120.0	2.4
5	*5720.00	112.3 AV			2.20 H	120	109.9	2.4
6	#5850.00	51.5 PK	68.2	-16.7	2.20 H	120	48.8	2.7
7	11440.00	55.9 PK	74.0	-18.1	1.32 H	333	43.5	12.4
8	11440.00	43.3 AV	54.0	-10.7	1.32 H	333	30.9	12.4
9	#17160.00	62.6 PK	68.2	-5.6	1.52 H	271	46.0	16.6

Antenna Polarity & Test Distance : Vertical at 3 m

No	Frequency (MHz)	Emission Level (dBuV/m)	Limit (dBuV/m)	Margin (dB)	Antenna Height (m)	Table Angle (Degree)	Raw Value (dBuV)	Correction Factor (dB/m)
1	5460.00	51.1 PK	74.0	-22.9	1.29 V	117	49.0	2.1
2	5460.00	38.1 AV	54.0	-15.9	1.29 V	117	36.0	2.1
3	#5470.00	52.5 PK	68.2	-15.7	1.29 V	117	50.3	2.2
4	*5720.00	118.4 PK			1.29 V	117	116.0	2.4
5	*5720.00	106.2 AV			1.29 V	117	103.8	2.4
6	#5850.00	50.8 PK	68.2	-17.4	1.29 V	117	48.1	2.7
7	11440.00	55.2 PK	74.0	-18.8	1.50 V	317	42.8	12.4
8	11440.00	44.0 AV	54.0	-10.0	1.50 V	317	31.6	12.4
9	#17160.00	61.3 PK	68.2	-6.9	1.68 V	302	44.7	16.6

Remarks:

1. Emission Level(dBuV/m) = Raw Value(dBuV) + Correction Factor(dB/m)
2. Correction Factor(dB/m) = Antenna Factor(dB/m) + Cable Factor(dB) – Pre-Amplifier Factor(dB)
3. Margin value = Emission Level – Limit value
4. The other emission levels were very low against the limit.
5. " * ": Fundamental frequency.
6. " # ": The radiated frequency is out of the restricted band.

RF Mode	TX 20MHz Preamble 802.11ax (RU52)	Channel	CH 149 : 5745 MHz
Frequency Range	1GHz ~ 40GHz	Detector Function	Peak (PK) Average (AV)

Antenna Polarity & Test Distance : Horizontal at 3 m

No	Frequency (MHz)	Emission Level (dBuV/m)	Limit (dBuV/m)	Margin (dB)	Antenna Height (m)	Table Angle (Degree)	Raw Value (dBuV)	Correction Factor (dB/m)
1	#5559.08	52.5 PK	68.2	-15.7	2.10 H	107	50.4	2.1
2	*5745.00	125.2 PK			2.10 H	107	122.8	2.4
3	*5745.00	115.2 AV			2.10 H	107	112.8	2.4
4	#5954.77	51.7 PK	68.2	-16.5	2.10 H	107	48.8	2.9
5	11490.00	58.1 PK	74.0	-15.9	1.30 H	358	45.5	12.6
6	11490.00	46.8 AV	54.0	-7.2	1.30 H	358	34.2	12.6
7	#17235.00	62.8 PK	68.2	-5.4	1.53 H	284	46.0	16.8

Antenna Polarity & Test Distance : Vertical at 3 m

No	Frequency (MHz)	Emission Level (dBuV/m)	Limit (dBuV/m)	Margin (dB)	Antenna Height (m)	Table Angle (Degree)	Raw Value (dBuV)	Correction Factor (dB/m)
1	#5641.81	52.3 PK	68.2	-15.9	1.02 V	121	50.0	2.3
2	*5745.00	116.4 PK			1.02 V	121	114.0	2.4
3	*5745.00	105.8 AV			1.02 V	121	103.4	2.4
4	#5960.79	51.9 PK	68.2	-16.3	1.02 V	121	49.0	2.9
5	11490.00	58.4 PK	74.0	-15.6	1.51 V	295	45.8	12.6
6	11490.00	46.8 AV	54.0	-7.2	1.51 V	295	34.2	12.6
7	#17235.00	61.0 PK	68.2	-7.2	1.64 V	277	44.2	16.8

Remarks:

1. Emission Level(dBuV/m) = Raw Value(dBuV) + Correction Factor(dB/m)
2. Correction Factor(dB/m) = Antenna Factor(dB/m) + Cable Factor(dB) – Pre-Amplifier Factor(dB)
3. Margin value = Emission Level – Limit value
4. The other emission levels were very low against the limit.
5. " * ": Fundamental frequency.
6. " # ": The radiated frequency is out of the restricted band.

RF Mode	TX 20MHz Preamble 802.11ax (RU52)	Channel	CH 157 : 5785 MHz
Frequency Range	1GHz ~ 40GHz	Detector Function	Peak (PK) Average (AV)

Antenna Polarity & Test Distance : Horizontal at 3 m

No	Frequency (MHz)	Emission Level (dBuV/m)	Limit (dBuV/m)	Margin (dB)	Antenna Height (m)	Table Angle (Degree)	Raw Value (dBuV)	Correction Factor (dB/m)
1	#5588.23	52.5 PK	68.2	-15.7	2.03 H	106	50.4	2.1
2	*5785.00	125.5 PK			2.03 H	106	122.9	2.6
3	*5785.00	115.4 AV			2.03 H	106	112.8	2.6
4	#5940.20	51.8 PK	68.2	-16.4	2.03 H	106	48.9	2.9
5	11570.00	56.3 PK	74.0	-17.7	1.29 H	360	43.7	12.6
6	11570.00	45.4 AV	54.0	-8.6	1.29 H	360	32.8	12.6
7	#17355.00	63.6 PK	68.2	-4.6	1.48 H	287	45.9	17.7

Antenna Polarity & Test Distance : Vertical at 3 m

No	Frequency (MHz)	Emission Level (dBuV/m)	Limit (dBuV/m)	Margin (dB)	Antenna Height (m)	Table Angle (Degree)	Raw Value (dBuV)	Correction Factor (dB/m)
1	#5591.37	50.8 PK	68.2	-17.4	1.05 V	119	48.7	2.1
2	*5785.00	116.6 PK			1.05 V	119	114.0	2.6
3	*5785.00	106.1 AV			1.05 V	119	103.5	2.6
4	#5985.01	50.1 PK	68.2	-18.1	1.05 V	119	47.2	2.9
5	11570.00	58.1 PK	74.0	-15.9	1.49 V	306	45.5	12.6
6	11570.00	46.7 AV	54.0	-7.3	1.49 V	306	34.1	12.6
7	#17355.00	60.9 PK	68.2	-7.3	1.58 V	280	43.2	17.7

Remarks:

1. Emission Level(dBuV/m) = Raw Value(dBuV) + Correction Factor(dB/m)
2. Correction Factor(dB/m) = Antenna Factor(dB/m) + Cable Factor(dB) – Pre-Amplifier Factor(dB)
3. Margin value = Emission Level – Limit value
4. The other emission levels were very low against the limit.
5. " * ": Fundamental frequency.
6. " # ": The radiated frequency is out of the restricted band.

RF Mode	TX 20MHz Preamble 802.11ax (RU52)	Channel	CH 165 : 5825 MHz
Frequency Range	1GHz ~ 40GHz	Detector Function	Peak (PK) Average (AV)

Antenna Polarity & Test Distance : Horizontal at 3 m

No	Frequency (MHz)	Emission Level (dBuV/m)	Limit (dBuV/m)	Margin (dB)	Antenna Height (m)	Table Angle (Degree)	Raw Value (dBuV)	Correction Factor (dB/m)
1	#5584.16	52.4 PK	68.2	-15.8	2.06 H	101	50.3	2.1
2	*5825.00	125.7 PK			2.06 H	101	123.1	2.6
3	*5825.00	115.5 AV			2.06 H	101	112.9	2.6
4	#5981.86	51.6 PK	68.2	-16.6	2.06 H	101	48.7	2.9
5	11650.00	57.0 PK	74.0	-17.0	1.30 H	354	44.8	12.2
6	11650.00	45.9 AV	54.0	-8.1	1.30 H	354	33.7	12.2
7	#17475.00	64.8 PK	68.2	-3.4	1.45 H	289	46.1	18.7

Antenna Polarity & Test Distance : Vertical at 3 m

No	Frequency (MHz)	Emission Level (dBuV/m)	Limit (dBuV/m)	Margin (dB)	Antenna Height (m)	Table Angle (Degree)	Raw Value (dBuV)	Correction Factor (dB/m)
1	#5606.76	51.0 PK	68.2	-17.2	1.10 V	123	48.9	2.1
2	*5825.00	116.9 PK			1.10 V	123	114.3	2.6
3	*5825.00	106.3 AV			1.10 V	123	103.7	2.6
4	#5947.16	51.2 PK	68.2	-17.0	1.10 V	123	48.3	2.9
5	11650.00	57.9 PK	74.0	-16.1	1.46 V	308	45.7	12.2
6	11650.00	46.5 AV	54.0	-7.5	1.46 V	308	34.3	12.2
7	#17475.00	60.4 PK	68.2	-7.8	1.57 V	266	41.7	18.7

Remarks:

1. Emission Level(dBuV/m) = Raw Value(dBuV) + Correction Factor(dB/m)
2. Correction Factor(dB/m) = Antenna Factor(dB/m) + Cable Factor(dB) – Pre-Amplifier Factor(dB)
3. Margin value = Emission Level – Limit value
4. The other emission levels were very low against the limit.
5. " * ": Fundamental frequency.
6. " # ": The radiated frequency is out of the restricted band.

RF Mode	TX 20MHz Preamble 802.11ax (RU106)	Channel	CH 36 : 5180 MHz
Frequency Range	1GHz ~ 40GHz	Detector Function	Peak (PK) Average (AV)

Antenna Polarity & Test Distance : Horizontal at 3 m								
No	Frequency (MHz)	Emission Level (dBuV/m)	Limit (dBuV/m)	Margin (dB)	Antenna Height (m)	Table Angle (Degree)	Raw Value (dBuV)	Correction Factor (dB/m)
1	5137.40	55.8 PK	74.0	-18.2	1.90 H	129	53.5	2.3
2	5137.40	45.9 AV	54.0	-8.1	1.90 H	129	43.6	2.3
3	5148.80	58.7 PK	74.0	-15.3	1.90 H	129	56.4	2.3
4	5148.80	44.9 AV	54.0	-9.1	1.90 H	129	42.6	2.3
5	*5180.00	120.3 PK			1.90 H	129	118.1	2.2
6	*5180.00	109.1 AV			1.90 H	129	106.9	2.2
7	#10360.00	53.8 PK	68.2	-14.4	1.30 H	347	42.0	11.8
8	15540.00	60.4 PK	74.0	-13.6	1.53 H	300	48.6	11.8
9	15540.00	47.2 AV	54.0	-6.8	1.53 H	300	35.4	11.8
Antenna Polarity & Test Distance : Vertical at 3 m								
No	Frequency (MHz)	Emission Level (dBuV/m)	Limit (dBuV/m)	Margin (dB)	Antenna Height (m)	Table Angle (Degree)	Raw Value (dBuV)	Correction Factor (dB/m)
1	5148.40	51.8 PK	74.0	-22.2	1.59 V	120	49.5	2.3
2	5148.40	40.6 AV	54.0	-13.4	1.59 V	120	38.3	2.3
3	*5180.00	114.6 PK			1.59 V	120	112.4	2.2
4	*5180.00	101.6 AV			1.59 V	120	99.4	2.2
5	#10360.00	55.2 PK	68.2	-13.0	1.44 V	316	43.4	11.8
6	15540.00	59.2 PK	74.0	-14.8	1.52 V	284	47.4	11.8
7	15540.00	46.8 AV	54.0	-7.2	1.52 V	284	35.0	11.8

Remarks:

1. Emission Level(dBuV/m) = Raw Value(dBuV) + Correction Factor(dB/m)
2. Correction Factor(dB/m) = Antenna Factor(dB/m) + Cable Factor(dB) – Pre-Amplifier Factor(dB)
3. Margin value = Emission Level – Limit value
4. The other emission levels were very low against the limit.
5. " * ": Fundamental frequency.
6. " # ": The radiated frequency is out of the restricted band.

RF Mode	TX 20MHz Preamble 802.11ax (RU106)	Channel	CH 40 : 5200 MHz
Frequency Range	1GHz ~ 40GHz	Detector Function	Peak (PK) Average (AV)

Antenna Polarity & Test Distance : Horizontal at 3 m

No	Frequency (MHz)	Emission Level (dBuV/m)	Limit (dBuV/m)	Margin (dB)	Antenna Height (m)	Table Angle (Degree)	Raw Value (dBuV)	Correction Factor (dB/m)
1	5150.00	54.6 PK	74.0	-19.4	1.92 H	143	52.3	2.3
2	5150.00	44.0 AV	54.0	-10.0	1.92 H	143	41.7	2.3
3	*5200.00	120.2 PK			1.92 H	143	118.1	2.1
4	*5200.00	108.9 AV			1.92 H	143	106.8	2.1
5	#10400.00	54.2 PK	68.2	-14.0	1.27 H	355	42.2	12.0
6	15600.00	60.4 PK	74.0	-13.6	1.52 H	309	48.9	11.5
7	15600.00	47.2 AV	54.0	-6.8	1.52 H	309	35.7	11.5

Antenna Polarity & Test Distance : Vertical at 3 m

No	Frequency (MHz)	Emission Level (dBuV/m)	Limit (dBuV/m)	Margin (dB)	Antenna Height (m)	Table Angle (Degree)	Raw Value (dBuV)	Correction Factor (dB/m)
1	5150.00	52.9 PK	74.0	-21.1	1.58 V	123	50.6	2.3
2	5150.00	42.4 AV	54.0	-11.6	1.58 V	123	40.1	2.3
3	*5200.00	114.7 PK			1.58 V	123	112.6	2.1
4	*5200.00	101.9 AV			1.58 V	123	99.8	2.1
5	#10400.00	55.1 PK	68.2	-13.1	1.45 V	305	43.1	12.0
6	15600.00	59.5 PK	74.0	-14.5	1.53 V	273	48.0	11.5
7	15600.00	47.2 AV	54.0	-6.8	1.53 V	273	35.7	11.5

Remarks:

1. Emission Level(dBuV/m) = Raw Value(dBuV) + Correction Factor(dB/m)
2. Correction Factor(dB/m) = Antenna Factor(dB/m) + Cable Factor(dB) – Pre-Amplifier Factor(dB)
3. Margin value = Emission Level – Limit value
4. The other emission levels were very low against the limit.
5. " * ": Fundamental frequency.
6. " # ": The radiated frequency is out of the restricted band.

RF Mode	TX 20MHz Preamble 802.11ax (RU106)	Channel	CH 48 : 5240 MHz
Frequency Range	1GHz ~ 40GHz	Detector Function	Peak (PK) Average (AV)

Antenna Polarity & Test Distance : Horizontal at 3 m

No	Frequency (MHz)	Emission Level (dBuV/m)	Limit (dBuV/m)	Margin (dB)	Antenna Height (m)	Table Angle (Degree)	Raw Value (dBuV)	Correction Factor (dB/m)
1	5150.00	52.5 PK	74.0	-21.5	1.86 H	115	50.2	2.3
2	5150.00	38.6 AV	54.0	-15.4	1.86 H	115	36.3	2.3
3	*5240.00	120.2 PK			1.86 H	115	118.2	2.0
4	*5240.00	108.7 AV			1.86 H	115	106.7	2.0
5	5350.00	51.3 PK	74.0	-22.7	1.86 H	115	49.4	1.9
6	5350.00	38.2 AV	54.0	-15.8	1.86 H	115	36.3	1.9
7	#10480.00	53.1 PK	68.2	-15.1	1.25 H	343	41.2	11.9
8	15720.00	60.2 PK	74.0	-13.8	1.49 H	300	48.4	11.8
9	15720.00	47.0 AV	54.0	-7.0	1.49 H	300	35.2	11.8

Antenna Polarity & Test Distance : Vertical at 3 m

No	Frequency (MHz)	Emission Level (dBuV/m)	Limit (dBuV/m)	Margin (dB)	Antenna Height (m)	Table Angle (Degree)	Raw Value (dBuV)	Correction Factor (dB/m)
1	5150.00	52.7 PK	74.0	-21.3	1.59 V	135	50.4	2.3
2	5150.00	38.6 AV	54.0	-15.4	1.59 V	135	36.3	2.3
3	*5240.00	114.8 PK			1.59 V	135	112.8	2.0
4	*5240.00	101.9 AV			1.59 V	135	99.9	2.0
5	5350.00	49.7 PK	74.0	-24.3	1.59 V	135	47.8	1.9
6	5350.00	36.6 AV	54.0	-17.4	1.59 V	135	34.7	1.9
7	#10480.00	54.8 PK	68.2	-13.4	1.44 V	310	42.9	11.9
8	15720.00	59.0 PK	74.0	-15.0	1.52 V	280	47.2	11.8
9	15720.00	46.9 AV	54.0	-7.1	1.52 V	280	35.1	11.8

Remarks:

1. Emission Level(dBuV/m) = Raw Value(dBuV) + Correction Factor(dB/m)
2. Correction Factor(dB/m) = Antenna Factor(dB/m) + Cable Factor(dB) – Pre-Amplifier Factor(dB)
3. Margin value = Emission Level – Limit value
4. The other emission levels were very low against the limit.
5. " * ": Fundamental frequency.
6. " # ": The radiated frequency is out of the restricted band.

RF Mode	TX 20MHz Preamble 802.11ax (RU106)	Channel	CH 52 : 5260 MHz
Frequency Range	1GHz ~ 40GHz	Detector Function	Peak (PK) Average (AV)

Antenna Polarity & Test Distance : Horizontal at 3 m

No	Frequency (MHz)	Emission Level (dBuV/m)	Limit (dBuV/m)	Margin (dB)	Antenna Height (m)	Table Angle (Degree)	Raw Value (dBuV)	Correction Factor (dB/m)
1	5150.00	52.3 PK	74.0	-21.7	1.88 H	115	50.0	2.3
2	5150.00	38.6 AV	54.0	-15.4	1.88 H	115	36.3	2.3
3	*5260.00	120.3 PK			1.88 H	115	118.3	2.0
4	*5260.00	109.0 AV			1.88 H	115	107.0	2.0
5	5350.00	50.1 PK	74.0	-23.9	1.88 H	115	48.2	1.9
6	5350.00	37.4 AV	54.0	-16.6	1.88 H	115	35.5	1.9
7	#10520.00	54.2 PK	68.2	-14.0	1.25 H	357	42.2	12.0
8	15780.00	60.1 PK	74.0	-13.9	1.56 H	300	48.6	11.5
9	15780.00	47.1 AV	54.0	-6.9	1.56 H	300	35.6	11.5

Antenna Polarity & Test Distance : Vertical at 3 m

No	Frequency (MHz)	Emission Level (dBuV/m)	Limit (dBuV/m)	Margin (dB)	Antenna Height (m)	Table Angle (Degree)	Raw Value (dBuV)	Correction Factor (dB/m)
1	5150.00	52.4 PK	74.0	-21.6	1.56 V	119	50.1	2.3
2	5150.00	38.1 AV	54.0	-15.9	1.56 V	119	35.8	2.3
3	*5260.00	115.2 PK			1.56 V	119	113.2	2.0
4	*5260.00	102.1 AV			1.56 V	119	100.1	2.0
5	5350.00	50.0 PK	74.0	-24.0	1.56 V	119	48.1	1.9
6	5350.00	36.9 AV	54.0	-17.1	1.56 V	119	35.0	1.9
7	#10520.00	55.0 PK	68.2	-13.2	1.49 V	313	43.0	12.0
8	15780.00	58.8 PK	74.0	-15.2	1.57 V	294	47.3	11.5
9	15780.00	46.6 AV	54.0	-7.4	1.57 V	294	35.1	11.5

Remarks:

1. Emission Level(dBuV/m) = Raw Value(dBuV) + Correction Factor(dB/m)
2. Correction Factor(dB/m) = Antenna Factor(dB/m) + Cable Factor(dB) – Pre-Amplifier Factor(dB)
3. Margin value = Emission Level – Limit value
4. The other emission levels were very low against the limit.
5. " * ": Fundamental frequency.
6. " # ": The radiated frequency is out of the restricted band.

RF Mode	TX 20MHz Preamble 802.11ax (RU106)	Channel	CH 60 : 5300 MHz
Frequency Range	1GHz ~ 40GHz	Detector Function	Peak (PK) Average (AV)

Antenna Polarity & Test Distance : Horizontal at 3 m

No	Frequency (MHz)	Emission Level (dBuV/m)	Limit (dBuV/m)	Margin (dB)	Antenna Height (m)	Table Angle (Degree)	Raw Value (dBuV)	Correction Factor (dB/m)
1	*5300.00	120.3 PK			1.95 H	127	118.6	1.7
2	*5300.00	109.3 AV			1.95 H	127	107.6	1.7
3	5350.00	54.3 PK	74.0	-19.7	1.95 H	127	52.4	1.9
4	5350.00	43.8 AV	54.0	-10.2	1.95 H	127	41.9	1.9
5	10600.00	53.8 PK	74.0	-20.2	1.35 H	346	41.9	11.9
6	10600.00	42.7 AV	54.0	-11.3	1.35 H	346	30.8	11.9
7	15900.00	61.1 PK	74.0	-12.9	1.54 H	306	49.8	11.3
8	15900.00	47.7 AV	54.0	-6.3	1.54 H	306	36.4	11.3

Antenna Polarity & Test Distance : Vertical at 3 m

No	Frequency (MHz)	Emission Level (dBuV/m)	Limit (dBuV/m)	Margin (dB)	Antenna Height (m)	Table Angle (Degree)	Raw Value (dBuV)	Correction Factor (dB/m)
1	*5300.00	114.5 PK			1.60 V	112	112.8	1.7
2	*5300.00	101.5 AV			1.60 V	112	99.8	1.7
3	5350.00	52.5 PK	74.0	-21.5	1.60 V	112	50.6	1.9
4	5350.00	41.7 AV	54.0	-12.3	1.60 V	112	39.8	1.9
5	10600.00	54.6 PK	74.0	-19.4	1.47 V	311	42.7	11.9
6	10600.00	43.8 AV	54.0	-10.2	1.47 V	311	31.9	11.9
7	15900.00	59.8 PK	74.0	-14.2	1.47 V	281	48.5	11.3
8	15900.00	47.4 AV	54.0	-6.6	1.47 V	281	36.1	11.3

Remarks:

1. Emission Level(dBuV/m) = Raw Value(dBuV) + Correction Factor(dB/m)
2. Correction Factor(dB/m) = Antenna Factor(dB/m) + Cable Factor(dB) – Pre-Amplifier Factor(dB)
3. Margin value = Emission Level – Limit value
4. The other emission levels were very low against the limit.
5. " * ": Fundamental frequency.

RF Mode	TX 20MHz Preamble 802.11ax (RU106)	Channel	CH 64 : 5320 MHz
Frequency Range	1GHz ~ 40GHz	Detector Function	Peak (PK) Average (AV)

Antenna Polarity & Test Distance : Horizontal at 3 m

No	Frequency (MHz)	Emission Level (dBuV/m)	Limit (dBuV/m)	Margin (dB)	Antenna Height (m)	Table Angle (Degree)	Raw Value (dBuV)	Correction Factor (dB/m)
1	*5320.00	120.8 PK			2.00 H	118	119.0	1.8
2	*5320.00	109.8 AV			2.00 H	118	108.0	1.8
3	5351.80	70.8 PK	74.0	-3.2	2.00 H	118	68.9	1.9
4	5351.80	45.5 AV	54.0	-8.5	2.00 H	118	43.6	1.9
5	10640.00	53.3 PK	74.0	-20.7	1.32 H	334	41.5	11.8
6	10640.00	42.6 AV	54.0	-11.4	1.32 H	334	30.8	11.8
7	15960.00	60.8 PK	74.0	-13.2	1.49 H	315	49.2	11.6
8	15960.00	47.3 AV	54.0	-6.7	1.49 H	315	35.7	11.6

Antenna Polarity & Test Distance : Vertical at 3 m

No	Frequency (MHz)	Emission Level (dBuV/m)	Limit (dBuV/m)	Margin (dB)	Antenna Height (m)	Table Angle (Degree)	Raw Value (dBuV)	Correction Factor (dB/m)
1	*5320.00	112.3 PK			1.48 V	129	110.5	1.8
2	*5320.00	101.9 AV			1.48 V	129	100.1	1.8
3	5351.80	56.0 PK	74.0	-18.0	1.48 V	129	54.1	1.9
4	5351.80	39.2 AV	54.0	-14.8	1.48 V	129	37.3	1.9
5	5362.10	51.1 PK	74.0	-22.9	1.48 V	129	49.1	2.0
6	5362.10	40.4 AV	54.0	-13.6	1.48 V	129	38.4	2.0
7	10640.00	54.6 PK	74.0	-19.4	1.49 V	304	42.8	11.8
8	10640.00	44.0 AV	54.0	-10.0	1.49 V	304	32.2	11.8
9	15960.00	59.3 PK	74.0	-14.7	1.48 V	284	47.7	11.6
10	15960.00	47.0 AV	54.0	-7.0	1.48 V	284	35.4	11.6

Remarks:

1. Emission Level(dBuV/m) = Raw Value(dBuV) + Correction Factor(dB/m)
2. Correction Factor(dB/m) = Antenna Factor(dB/m) + Cable Factor(dB) – Pre-Amplifier Factor(dB)
3. Margin value = Emission Level – Limit value
4. The other emission levels were very low against the limit.
5. " * ": Fundamental frequency.

RF Mode	TX 20MHz Preamble 802.11ax (RU106)	Channel	CH 100 : 5500 MHz
Frequency Range	1GHz ~ 40GHz	Detector Function	Peak (PK) Average (AV)

Antenna Polarity & Test Distance : Horizontal at 3 m

No	Frequency (MHz)	Emission Level (dBuV/m)	Limit (dBuV/m)	Margin (dB)	Antenna Height (m)	Table Angle (Degree)	Raw Value (dBuV)	Correction Factor (dB/m)
1	5458.36	56.4 PK	74.0	-17.6	2.01 H	118	54.3	2.1
2	5458.36	46.4 AV	54.0	-7.6	2.01 H	118	44.3	2.1
3	#5464.82	66.1 PK	68.2	-2.1	2.01 H	118	64.0	2.1
4	*5500.00	121.3 PK			2.01 H	118	119.2	2.1
5	*5500.00	110.2 AV			2.01 H	118	108.1	2.1
6	11000.00	54.0 PK	74.0	-20.0	1.36 H	349	41.6	12.4
7	11000.00	43.2 AV	54.0	-10.8	1.36 H	349	30.8	12.4
8	#16500.00	60.7 PK	68.2	-7.5	1.55 H	310	47.0	13.7

Antenna Polarity & Test Distance : Vertical at 3 m

No	Frequency (MHz)	Emission Level (dBuV/m)	Limit (dBuV/m)	Margin (dB)	Antenna Height (m)	Table Angle (Degree)	Raw Value (dBuV)	Correction Factor (dB/m)
1	5451.60	48.9 PK	74.0	-25.1	1.47 V	125	46.8	2.1
2	5451.60	39.1 AV	54.0	-14.9	1.47 V	125	37.0	2.1
3	5458.90	51.5 PK	74.0	-22.5	1.47 V	125	49.4	2.1
4	5458.90	38.5 AV	54.0	-15.5	1.47 V	125	36.4	2.1
5	#5467.60	61.4 PK	68.2	-6.8	1.47 V	125	59.2	2.2
6	*5500.00	113.7 PK			1.47 V	125	111.6	2.1
7	*5500.00	102.2 AV			1.47 V	125	100.1	2.1
8	11000.00	54.2 PK	74.0	-19.8	1.41 V	305	41.8	12.4
9	11000.00	43.7 AV	54.0	-10.3	1.41 V	305	31.3	12.4
10	#16500.00	59.0 PK	68.2	-9.2	1.53 V	272	45.3	13.7

Remarks:

1. Emission Level(dBuV/m) = Raw Value(dBuV) + Correction Factor(dB/m)
2. Correction Factor(dB/m) = Antenna Factor(dB/m) + Cable Factor(dB) – Pre-Amplifier Factor(dB)
3. Margin value = Emission Level – Limit value
4. The other emission levels were very low against the limit.
5. " * ": Fundamental frequency.
6. " # ": The radiated frequency is out of the restricted band.

RF Mode	TX 20MHz Preamble 802.11ax (RU106)	Channel	CH 116 : 5580 MHz
Frequency Range	1GHz ~ 40GHz	Detector Function	Peak (PK) Average (AV)

Antenna Polarity & Test Distance : Horizontal at 3 m

No	Frequency (MHz)	Emission Level (dBuV/m)	Limit (dBuV/m)	Margin (dB)	Antenna Height (m)	Table Angle (Degree)	Raw Value (dBuV)	Correction Factor (dB/m)
1	*5580.00	120.3 PK			1.89 H	137	118.2	2.1
2	*5580.00	109.4 AV			1.89 H	137	107.3	2.1
3	11160.00	54.1 PK	74.0	-19.9	1.35 H	347	42.1	12.0
4	11160.00	42.9 AV	54.0	-11.1	1.35 H	347	30.9	12.0
5	#16740.00	60.6 PK	68.2	-7.6	1.47 H	306	45.3	15.3

Antenna Polarity & Test Distance : Vertical at 3 m

No	Frequency (MHz)	Emission Level (dBuV/m)	Limit (dBuV/m)	Margin (dB)	Antenna Height (m)	Table Angle (Degree)	Raw Value (dBuV)	Correction Factor (dB/m)
1	*5580.00	114.8 PK			1.54 V	122	112.7	2.1
2	*5580.00	101.6 AV			1.54 V	122	99.5	2.1
3	11160.00	55.0 PK	74.0	-19.0	1.49 V	295	43.0	12.0
4	11160.00	44.1 AV	54.0	-9.9	1.49 V	295	32.1	12.0
5	#16740.00	58.2 PK	68.2	-10.0	1.51 V	283	42.9	15.3

Remarks:

1. Emission Level(dBuV/m) = Raw Value(dBuV) + Correction Factor(dB/m)
2. Correction Factor(dB/m) = Antenna Factor(dB/m) + Cable Factor(dB) – Pre-Amplifier Factor(dB)
3. Margin value = Emission Level – Limit value
4. The other emission levels were very low against the limit.
5. " * ": Fundamental frequency.
6. " # ": The radiated frequency is out of the restricted band.

RF Mode	TX 20MHz Preamble 802.11ax (RU106)	Channel	CH 140 : 5700 MHz
Frequency Range	1GHz ~ 40GHz	Detector Function	Peak (PK) Average (AV)

Antenna Polarity & Test Distance : Horizontal at 3 m

No	Frequency (MHz)	Emission Level (dBuV/m)	Limit (dBuV/m)	Margin (dB)	Antenna Height (m)	Table Angle (Degree)	Raw Value (dBuV)	Correction Factor (dB/m)
1	*5700.00	118.4 PK			2.00 H	127	116.1	2.3
2	*5700.00	107.4 AV			2.00 H	127	105.1	2.3
3	#5727.70	66.5 PK	68.2	-1.7	2.00 H	127	64.0	2.5
4	11400.00	53.6 PK	74.0	-20.4	1.26 H	354	41.1	12.5
5	11400.00	42.5 AV	54.0	-11.5	1.26 H	354	30.0	12.5
6	#17100.00	60.1 PK	68.2	-8.1	1.56 H	300	43.3	16.8

Antenna Polarity & Test Distance : Vertical at 3 m

No	Frequency (MHz)	Emission Level (dBuV/m)	Limit (dBuV/m)	Margin (dB)	Antenna Height (m)	Table Angle (Degree)	Raw Value (dBuV)	Correction Factor (dB/m)
1	*5700.00	112.7 PK			1.53 V	129	110.4	2.3
2	*5700.00	99.8 AV			1.53 V	129	97.5	2.3
3	#5725.00	60.6 PK	68.2	-7.6	1.53 V	129	58.2	2.4
4	11400.00	55.0 PK	74.0	-19.0	1.38 V	299	42.5	12.5
5	11400.00	44.0 AV	54.0	-10.0	1.38 V	299	31.5	12.5
6	#17100.00	59.4 PK	68.2	-8.8	1.46 V	279	42.6	16.8

Remarks:

1. Emission Level(dBuV/m) = Raw Value(dBuV) + Correction Factor(dB/m)
2. Correction Factor(dB/m) = Antenna Factor(dB/m) + Cable Factor(dB) – Pre-Amplifier Factor(dB)
3. Margin value = Emission Level – Limit value
4. The other emission levels were very low against the limit.
5. " * ": Fundamental frequency.
6. " # ": The radiated frequency is out of the restricted band.

RF Mode	TX 20MHz Preamble 802.11ax (RU106)	Channel	CH 144 : 5720 MHz
Frequency Range	1GHz ~ 40GHz	Detector Function	Peak (PK) Average (AV)

Antenna Polarity & Test Distance : Horizontal at 3 m

No	Frequency (MHz)	Emission Level (dBuV/m)	Limit (dBuV/m)	Margin (dB)	Antenna Height (m)	Table Angle (Degree)	Raw Value (dBuV)	Correction Factor (dB/m)
1	5460.00	51.3 PK	74.0	-22.7	1.97 H	123	49.2	2.1
2	5460.00	38.9 AV	54.0	-15.1	1.97 H	123	36.8	2.1
3	#5470.00	51.6 PK	68.2	-16.6	1.97 H	123	49.4	2.2
4	*5720.00	120.5 PK			1.97 H	123	118.1	2.4
5	*5720.00	109.6 AV			1.97 H	123	107.2	2.4
6	#5850.00	51.5 PK	68.2	-16.7	1.97 H	123	48.8	2.7
7	11440.00	54.1 PK	74.0	-19.9	1.26 H	347	41.7	12.4
8	11440.00	43.0 AV	54.0	-11.0	1.26 H	347	30.6	12.4
9	#17160.00	60.6 PK	68.2	-7.6	1.52 H	303	44.0	16.6

Antenna Polarity & Test Distance : Vertical at 3 m

No	Frequency (MHz)	Emission Level (dBuV/m)	Limit (dBuV/m)	Margin (dB)	Antenna Height (m)	Table Angle (Degree)	Raw Value (dBuV)	Correction Factor (dB/m)
1	5460.00	51.3 PK	74.0	-22.7	1.55 V	129	49.2	2.1
2	5460.00	38.1 AV	54.0	-15.9	1.55 V	129	36.0	2.1
3	#5470.00	52.7 PK	68.2	-15.5	1.55 V	129	50.5	2.2
4	*5720.00	114.8 PK			1.55 V	129	112.4	2.4
5	*5720.00	101.5 AV			1.55 V	129	99.1	2.4
6	#5850.00	50.8 PK	68.2	-17.4	1.55 V	129	48.1	2.7
7	11440.00	54.2 PK	74.0	-19.8	1.44 V	324	41.8	12.4
8	11440.00	43.6 AV	54.0	-10.4	1.44 V	324	31.2	12.4
9	#17160.00	59.1 PK	68.2	-9.1	1.56 V	270	42.5	16.6

Remarks:

1. Emission Level(dBuV/m) = Raw Value(dBuV) + Correction Factor(dB/m)
2. Correction Factor(dB/m) = Antenna Factor(dB/m) + Cable Factor(dB) – Pre-Amplifier Factor(dB)
3. Margin value = Emission Level – Limit value
4. The other emission levels were very low against the limit.
5. " * ": Fundamental frequency.
6. " # ": The radiated frequency is out of the restricted band.

RF Mode	TX 20MHz Preamble 802.11ax (RU106)	Channel	CH 149 : 5745 MHz
Frequency Range	1GHz ~ 40GHz	Detector Function	Peak (PK) Average (AV)

Antenna Polarity & Test Distance : Horizontal at 3 m

No	Frequency (MHz)	Emission Level (dBuV/m)	Limit (dBuV/m)	Margin (dB)	Antenna Height (m)	Table Angle (Degree)	Raw Value (dBuV)	Correction Factor (dB/m)
1	#5559.75	53.7 PK	68.2	-14.5	1.86 H	127	51.6	2.1
2	*5745.00	122.2 PK			1.86 H	127	119.8	2.4
3	*5745.00	112.9 AV			1.86 H	127	110.5	2.4
4	#6003.71	52.1 PK	68.2	-16.1	1.86 H	127	49.2	2.9
5	11490.00	54.1 PK	74.0	-19.9	1.29 H	334	41.5	12.6
6	11490.00	43.1 AV	54.0	-10.9	1.29 H	334	30.5	12.6
7	#17235.00	61.1 PK	68.2	-7.1	1.54 H	287	44.3	16.8

Antenna Polarity & Test Distance : Vertical at 3 m

No	Frequency (MHz)	Emission Level (dBuV/m)	Limit (dBuV/m)	Margin (dB)	Antenna Height (m)	Table Angle (Degree)	Raw Value (dBuV)	Correction Factor (dB/m)
1	#5643.29	51.1 PK	68.2	-17.1	1.22 V	120	48.8	2.3
2	*5745.00	114.5 PK			1.22 V	120	112.1	2.4
3	*5745.00	105.1 AV			1.22 V	120	102.7	2.4
4	#6013.81	50.8 PK	68.2	-17.4	1.22 V	120	47.9	2.9
5	11490.00	57.1 PK	74.0	-16.9	1.49 V	305	44.5	12.6
6	11490.00	44.1 AV	54.0	-9.9	1.49 V	305	31.5	12.6
7	#17235.00	61.6 PK	68.2	-6.6	1.50 V	270	44.8	16.8

Remarks:

1. Emission Level(dBuV/m) = Raw Value(dBuV) + Correction Factor(dB/m)
2. Correction Factor(dB/m) = Antenna Factor(dB/m) + Cable Factor(dB) – Pre-Amplifier Factor(dB)
3. Margin value = Emission Level – Limit value
4. The other emission levels were very low against the limit.
5. " * ": Fundamental frequency.
6. " # ": The radiated frequency is out of the restricted band.

RF Mode	TX 20MHz Preamble 802.11ax (RU106)	Channel	CH 157 : 5785 MHz
Frequency Range	1GHz ~ 40GHz	Detector Function	Peak (PK) Average (AV)

Antenna Polarity & Test Distance : Horizontal at 3 m

No	Frequency (MHz)	Emission Level (dBuV/m)	Limit (dBuV/m)	Margin (dB)	Antenna Height (m)	Table Angle (Degree)	Raw Value (dBuV)	Correction Factor (dB/m)
1	#5587.09	52.7 PK	68.2	-15.5	1.94 H	128	50.6	2.1
2	*5785.00	123.3 PK			1.94 H	128	120.7	2.6
3	*5785.00	112.7 AV			1.94 H	128	110.1	2.6
4	#5980.46	52.1 PK	68.2	-16.1	1.94 H	128	49.2	2.9
5	11570.00	54.1 PK	74.0	-19.9	1.34 H	350	41.5	12.6
6	11570.00	43.3 AV	54.0	-10.7	1.34 H	350	30.7	12.6
7	#17355.00	60.6 PK	68.2	-7.6	1.51 H	303	42.9	17.7

Antenna Polarity & Test Distance : Vertical at 3 m

No	Frequency (MHz)	Emission Level (dBuV/m)	Limit (dBuV/m)	Margin (dB)	Antenna Height (m)	Table Angle (Degree)	Raw Value (dBuV)	Correction Factor (dB/m)
1	#5579.76	50.5 PK	68.2	-17.7	1.32 V	120	48.4	2.1
2	*5785.00	115.2 PK			1.32 V	120	112.6	2.6
3	*5785.00	104.6 AV			1.32 V	120	102.0	2.6
4	#5955.76	50.5 PK	68.2	-17.7	1.32 V	120	47.6	2.9
5	11570.00	54.8 PK	74.0	-19.2	1.48 V	324	42.2	12.6
6	11570.00	44.0 AV	54.0	-10.0	1.48 V	324	31.4	12.6
7	#17355.00	59.5 PK	68.2	-8.7	1.53 V	288	41.8	17.7

Remarks:

1. Emission Level(dBuV/m) = Raw Value(dBuV) + Correction Factor(dB/m)
2. Correction Factor(dB/m) = Antenna Factor(dB/m) + Cable Factor(dB) – Pre-Amplifier Factor(dB)
3. Margin value = Emission Level – Limit value
4. The other emission levels were very low against the limit.
5. " * ": Fundamental frequency.
6. " # ": The radiated frequency is out of the restricted band.

RF Mode	TX 20MHz Preamble 802.11ax (RU106)	Channel	CH 165 : 5825 MHz
Frequency Range	1GHz ~ 40GHz	Detector Function	Peak (PK) Average (AV)

Antenna Polarity & Test Distance : Horizontal at 3 m

No	Frequency (MHz)	Emission Level (dBuV/m)	Limit (dBuV/m)	Margin (dB)	Antenna Height (m)	Table Angle (Degree)	Raw Value (dBuV)	Correction Factor (dB/m)
1	#5597.60	53.2 PK	68.2	-15.0	1.89 H	121	51.1	2.1
2	*5825.00	123.5 PK			1.89 H	121	120.9	2.6
3	*5825.00	103.0 AV			1.89 H	121	100.4	2.6
4	#5927.54	52.8 PK	68.2	-15.4	1.89 H	121	49.9	2.9
5	11650.00	53.4 PK	74.0	-20.6	1.27 H	356	41.2	12.2
6	11650.00	42.6 AV	54.0	-11.4	1.27 H	356	30.4	12.2
7	#17475.00	60.4 PK	68.2	-7.8	1.55 H	315	41.7	18.7

Antenna Polarity & Test Distance : Vertical at 3 m

No	Frequency (MHz)	Emission Level (dBuV/m)	Limit (dBuV/m)	Margin (dB)	Antenna Height (m)	Table Angle (Degree)	Raw Value (dBuV)	Correction Factor (dB/m)
1	#5626.77	52.2 PK	68.2	-16.0	1.26 V	129	49.9	2.3
2	*5825.00	115.5 PK			1.26 V	129	112.9	2.6
3	*5825.00	105.0 AV			1.26 V	129	102.4	2.6
4	#5986.55	50.5 PK	68.2	-17.7	1.26 V	129	47.6	2.9
5	11650.00	55.0 PK	74.0	-19.0	1.47 V	322	42.8	12.2
6	11650.00	44.3 AV	54.0	-9.7	1.47 V	322	32.1	12.2
7	#17475.00	58.9 PK	68.2	-9.3	1.49 V	268	40.2	18.7

Remarks:

1. Emission Level(dBuV/m) = Raw Value(dBuV) + Correction Factor(dB/m)
2. Correction Factor(dB/m) = Antenna Factor(dB/m) + Cable Factor(dB) – Pre-Amplifier Factor(dB)
3. Margin value = Emission Level – Limit value
4. The other emission levels were very low against the limit.
5. " * ": Fundamental frequency.
6. " # ": The radiated frequency is out of the restricted band.

Below 1GHz Data:

RF Mode	TX 802.11a	Channel	CH 157 : 5785 MHz
Frequency Range	9kHz ~ 1GHz	Detector Function	Quasi-Peak (QP)

Antenna Polarity & Test Distance : Horizontal at 3 m								
No	Frequency (MHz)	Emission Level (dBuV/m)	Limit (dBuV/m)	Margin (dB)	Antenna Height (m)	Table Angle (Degree)	Raw Value (dBuV)	Correction Factor (dB/m)
1	120.00	38.2 QP	43.5	-5.3	3.00 H	359	53.3	-15.1
2	166.99	35.4 QP	43.5	-8.1	2.00 H	135	48.4	-13.0
3	226.19	33.2 QP	46.0	-12.8	2.00 H	135	49.1	-15.9
4	299.28	35.4 QP	46.0	-10.6	1.50 H	74	47.7	-12.3
5	337.18	33.8 QP	46.0	-12.2	1.50 H	339	45.1	-11.3
6	574.77	26.7 QP	46.0	-19.3	1.50 H	107	32.9	-6.2

Remarks:

1. Emission Level(dBuV/m) = Raw Value(dBuV) + Correction Factor(dB/m)
2. Correction Factor(dB/m) = Antenna Factor(dB/m) + Cable Factor(dB) – Pre-Amplifier Factor(dB)
3. Margin value = Emission Level – Limit value
4. The other emission levels were very low against the limit of frequency range 30MHz~1000MHz.
5. The emission levels were very low against the limit of frequency range 9kHz~30MHz: the amplitude of spurious emissions attenuated more than 20 dB below the permissible value to be report.

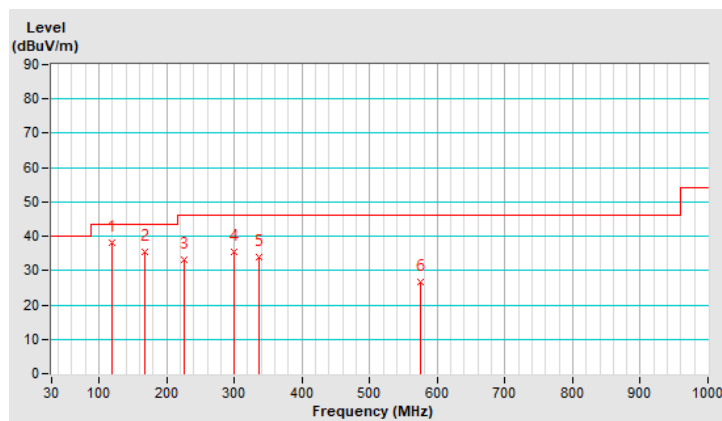

RF Mode	TX 802.11a	Channel	CH 157 : 5785 MHz
Frequency Range	9kHz ~ 1GHz	Detector Function	Quasi-Peak (QP)

Antenna Polarity & Test Distance : Vertical at 3 m

No	Frequency (MHz)	Emission Level (dBuV/m)	Limit (dBuV/m)	Margin (dB)	Antenna Height (m)	Table Angle (Degree)	Raw Value (dBuV)	Correction Factor (dB/m)
1	126.15	29.3 QP	43.5	-14.2	1.00 V	47	43.7	-14.4
2	166.88	32.4 QP	43.5	-11.1	1.50 V	217	45.4	-13.0
3	223.48	30.9 QP	46.0	-15.1	1.00 V	136	46.9	-16.0
4	340.39	25.7 QP	46.0	-20.3	1.50 V	179	37.0	-11.3
5	497.92	24.0 QP	46.0	-22.0	1.50 V	55	31.7	-7.7
6	949.88	32.9 QP	46.0	-13.1	1.00 V	145	33.5	-0.6

Remarks:

1. Emission Level(dBuV/m) = Raw Value(dBuV) + Correction Factor(dB/m)
2. Correction Factor(dB/m) = Antenna Factor(dB/m) + Cable Factor(dB) – Pre-Amplifier Factor(dB)
3. Margin value = Emission Level – Limit value
4. The other emission levels were very low against the limit of frequency range 30MHz~1000MHz.
5. The emission levels were very low against the limit of frequency range 9kHz~30MHz: the amplitude of spurious emissions attenuated more than 20 dB below the permissible value to be report.

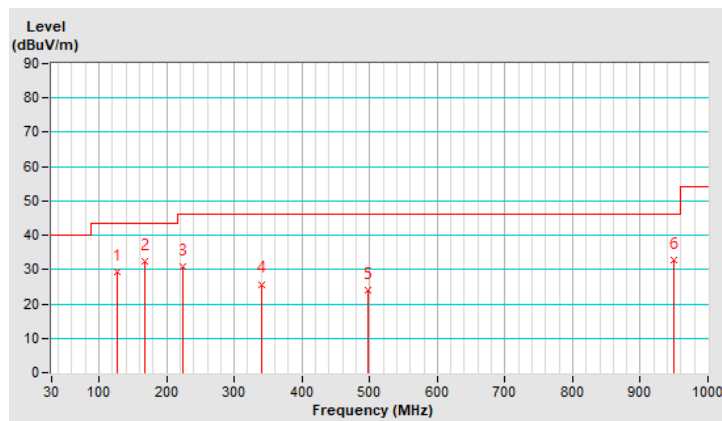

4.1.8 Test Results (Mode 2)

Dipole Antenna
Above 1GHz Data:

RF Mode	TX 802.11a	Channel	CH 36 : 5180 MHz
Frequency Range	1GHz ~ 40GHz	Detector Function	Peak (PK) Average (AV)

Antenna Polarity & Test Distance : Horizontal at 3 m

No	Frequency (MHz)	Emission Level (dBuV/m)	Limit (dBuV/m)	Margin (dB)	Antenna Height (m)	Table Angle (Degree)	Raw Value (dBuV)	Correction Factor (dB/m)
1	5150.00	60.7 PK	74.0	-13.3	1.01 H	112	58.4	2.3
2	5150.00	43.9 AV	54.0	-10.1	1.01 H	112	41.6	2.3
3	*5180.00	102.6 PK			1.01 H	112	100.4	2.2
4	*5180.00	93.5 AV			1.01 H	112	91.3	2.2
5	#10360.00	46.8 PK	68.2	-21.4	1.62 H	245	35.0	11.8
6	15540.00	54.4 PK	74.0	-19.6	1.29 H	310	42.6	11.8
7	15540.00	41.7 AV	54.0	-12.3	1.29 H	310	29.9	11.8

Antenna Polarity & Test Distance : Vertical at 3 m

No	Frequency (MHz)	Emission Level (dBuV/m)	Limit (dBuV/m)	Margin (dB)	Antenna Height (m)	Table Angle (Degree)	Raw Value (dBuV)	Correction Factor (dB/m)
1	5150.00	72.3 PK	74.0	-1.7	1.53 V	287	70.0	2.3
2	5150.00	52.3 AV	54.0	-1.7	1.53 V	287	50.0	2.3
3	*5180.00	113.7 PK			1.53 V	287	111.5	2.2
4	*5180.00	104.8 AV			1.53 V	287	102.6	2.2
5	#10360.00	49.0 PK	68.2	-19.2	2.13 V	357	37.2	11.8
6	15540.00	56.0 PK	74.0	-18.0	1.88 V	267	44.2	11.8
7	15540.00	43.1 AV	54.0	-10.9	1.88 V	267	31.3	11.8

Remarks:

1. Emission Level(dBuV/m) = Raw Value(dBuV) + Correction Factor(dB/m)
2. Correction Factor(dB/m) = Antenna Factor(dB/m) + Cable Factor(dB) – Pre-Amplifier Factor(dB)
3. Margin value = Emission Level – Limit value
4. The other emission levels were very low against the limit.
5. " * ": Fundamental frequency.
6. " # ": The radiated frequency is out of the restricted band.

RF Mode	TX 802.11a	Channel	CH 40 : 5200 MHz
Frequency Range	1GHz ~ 40GHz	Detector Function	Peak (PK) Average (AV)

Antenna Polarity & Test Distance : Horizontal at 3 m

No	Frequency (MHz)	Emission Level (dBuV/m)	Limit (dBuV/m)	Margin (dB)	Antenna Height (m)	Table Angle (Degree)	Raw Value (dBuV)	Correction Factor (dB/m)
1	5150.00	56.1 PK	74.0	-17.9	1.01 H	103	53.8	2.3
2	5150.00	40.3 AV	54.0	-13.7	1.01 H	103	38.0	2.3
3	*5200.00	102.4 PK			1.01 H	103	100.3	2.1
4	*5200.00	93.3 AV			1.01 H	103	91.2	2.1
5	#10400.00	46.0 PK	68.2	-22.2	1.68 H	228	34.0	12.0
6	15600.00	55.3 PK	74.0	-18.7	1.26 H	321	43.8	11.5
7	15600.00	42.3 AV	54.0	-11.7	1.26 H	321	30.8	11.5

Antenna Polarity & Test Distance : Vertical at 3 m

No	Frequency (MHz)	Emission Level (dBuV/m)	Limit (dBuV/m)	Margin (dB)	Antenna Height (m)	Table Angle (Degree)	Raw Value (dBuV)	Correction Factor (dB/m)
1	5150.00	57.4 PK	74.0	-16.6	1.56 V	276	55.1	2.3
2	5150.00	41.3 AV	54.0	-12.7	1.56 V	276	39.0	2.3
3	*5200.00	113.9 PK			1.56 V	276	111.8	2.1
4	*5200.00	105.2 AV			1.56 V	276	103.1	2.1
5	#10400.00	48.6 PK	68.2	-19.6	2.16 V	337	36.6	12.0
6	15600.00	56.3 PK	74.0	-17.7	1.95 V	253	44.8	11.5
7	15600.00	43.2 AV	54.0	-10.8	1.95 V	253	31.7	11.5

Remarks:

1. Emission Level(dBuV/m) = Raw Value(dBuV) + Correction Factor(dB/m)
2. Correction Factor(dB/m) = Antenna Factor(dB/m) + Cable Factor(dB) – Pre-Amplifier Factor(dB)
3. Margin value = Emission Level – Limit value
4. The other emission levels were very low against the limit.
5. " * ": Fundamental frequency.
6. " # ": The radiated frequency is out of the restricted band.

RF Mode	TX 802.11a	Channel	CH 48 : 5240 MHz
Frequency Range	1GHz ~ 40GHz	Detector Function	Peak (PK) Average (AV)

Antenna Polarity & Test Distance : Horizontal at 3 m

No	Frequency (MHz)	Emission Level (dBuV/m)	Limit (dBuV/m)	Margin (dB)	Antenna Height (m)	Table Angle (Degree)	Raw Value (dBuV)	Correction Factor (dB/m)
1	5150.00	50.7 PK	74.0	-23.3	1.06 H	98	48.4	2.3
2	5150.00	38.9 AV	54.0	-15.1	1.06 H	98	36.6	2.3
3	*5240.00	102.5 PK			1.06 H	98	100.5	2.0
4	*5240.00	93.3 AV			1.06 H	98	91.3	2.0
5	5350.00	50.9 PK	74.0	-23.1	1.06 H	98	49.0	1.9
6	5350.00	38.3 AV	54.0	-15.7	1.06 H	98	36.4	1.9
7	#10480.00	45.8 PK	68.2	-22.4	1.67 H	253	33.9	11.9
8	15720.00	54.9 PK	74.0	-19.1	1.31 H	311	43.1	11.8
9	15720.00	42.2 AV	54.0	-11.8	1.31 H	311	30.4	11.8

Antenna Polarity & Test Distance : Vertical at 3 m

No	Frequency (MHz)	Emission Level (dBuV/m)	Limit (dBuV/m)	Margin (dB)	Antenna Height (m)	Table Angle (Degree)	Raw Value (dBuV)	Correction Factor (dB/m)
1	5150.00	50.9 PK	74.0	-23.1	1.52 V	281	48.6	2.3
2	5150.00	39.0 AV	54.0	-15.0	1.52 V	281	36.7	2.3
3	*5240.00	113.7 PK			1.52 V	281	111.7	2.0
4	*5240.00	104.6 AV			1.52 V	281	102.6	2.0
5	5350.00	50.5 PK	74.0	-23.5	1.52 V	281	48.6	1.9
6	5350.00	38.1 AV	54.0	-15.9	1.52 V	281	36.2	1.9
7	#10480.00	48.6 PK	68.2	-19.6	2.15 V	339	36.7	11.9
8	15720.00	56.3 PK	74.0	-17.7	1.90 V	241	44.5	11.8
9	15720.00	42.9 AV	54.0	-11.1	1.90 V	241	31.1	11.8

Remarks:

1. Emission Level(dBuV/m) = Raw Value(dBuV) + Correction Factor(dB/m)
2. Correction Factor(dB/m) = Antenna Factor(dB/m) + Cable Factor(dB) – Pre-Amplifier Factor(dB)
3. Margin value = Emission Level – Limit value
4. The other emission levels were very low against the limit.
5. " * ": Fundamental frequency.
6. " # ": The radiated frequency is out of the restricted band.

RF Mode	TX 802.11a	Channel	CH 52 : 5260 MHz
Frequency Range	1GHz ~ 40GHz	Detector Function	Peak (PK) Average (AV)

Antenna Polarity & Test Distance : Horizontal at 3 m

No	Frequency (MHz)	Emission Level (dBuV/m)	Limit (dBuV/m)	Margin (dB)	Antenna Height (m)	Table Angle (Degree)	Raw Value (dBuV)	Correction Factor (dB/m)
1	5150.00	49.9 PK	74.0	-24.1	1.01 H	103	47.6	2.3
2	5150.00	37.8 AV	54.0	-16.2	1.01 H	103	35.5	2.3
3	*5260.00	101.8 PK			1.01 H	103	99.8	2.0
4	*5260.00	92.9 AV			1.01 H	103	90.9	2.0
5	5350.00	50.7 PK	74.0	-23.3	1.01 H	103	48.8	1.9
6	5350.00	39.2 AV	54.0	-14.8	1.01 H	103	37.3	1.9
7	#10520.00	46.3 PK	68.2	-21.9	1.68 H	233	34.3	12.0
8	15780.00	54.3 PK	74.0	-19.7	1.34 H	318	42.8	11.5
9	15780.00	41.4 AV	54.0	-12.6	1.34 H	318	29.9	11.5

Antenna Polarity & Test Distance : Vertical at 3 m

No	Frequency (MHz)	Emission Level (dBuV/m)	Limit (dBuV/m)	Margin (dB)	Antenna Height (m)	Table Angle (Degree)	Raw Value (dBuV)	Correction Factor (dB/m)
1	5150.00	50.2 PK	74.0	-23.8	1.47 V	295	47.9	2.3
2	5150.00	37.9 AV	54.0	-16.1	1.47 V	295	35.6	2.3
3	*5260.00	114.0 PK			1.47 V	295	112.0	2.0
4	*5260.00	105.1 AV			1.47 V	295	103.1	2.0
5	5350.00	51.1 PK	74.0	-22.9	1.47 V	295	49.2	1.9
6	5350.00	39.4 AV	54.0	-14.6	1.47 V	295	37.5	1.9
7	#10520.00	48.8 PK	68.2	-19.4	2.14 V	351	36.8	12.0
8	15780.00	56.7 PK	74.0	-17.3	1.89 V	237	45.2	11.5
9	15780.00	43.5 AV	54.0	-10.5	1.89 V	237	32.0	11.5

Remarks:

1. Emission Level(dBuV/m) = Raw Value(dBuV) + Correction Factor(dB/m)
2. Correction Factor(dB/m) = Antenna Factor(dB/m) + Cable Factor(dB) – Pre-Amplifier Factor(dB)
3. Margin value = Emission Level – Limit value
4. The other emission levels were very low against the limit.
5. " * ": Fundamental frequency.
6. " # ": The radiated frequency is out of the restricted band.

RF Mode	TX 802.11a	Channel	CH 60 : 5300 MHz
Frequency Range	1GHz ~ 40GHz	Detector Function	Peak (PK) Average (AV)

Antenna Polarity & Test Distance : Horizontal at 3 m								
No	Frequency (MHz)	Emission Level (dBuV/m)	Limit (dBuV/m)	Margin (dB)	Antenna Height (m)	Table Angle (Degree)	Raw Value (dBuV)	Correction Factor (dB/m)
1	*5300.00	101.9 PK			1.00 H	101	100.2	1.7
2	*5300.00	92.9 AV			1.00 H	101	91.2	1.7
3	5350.00	55.3 PK	74.0	-18.7	1.00 H	101	53.4	1.9
4	5350.00	39.6 AV	54.0	-14.4	1.00 H	101	37.7	1.9
5	10600.00	46.1 PK	74.0	-27.9	1.65 H	226	34.2	11.9
6	10600.00	35.8 AV	54.0	-18.2	1.65 H	226	23.9	11.9
7	15900.00	54.6 PK	74.0	-19.4	1.33 H	316	43.3	11.3
8	15900.00	41.7 AV	54.0	-12.3	1.33 H	316	30.4	11.3

Antenna Polarity & Test Distance : Vertical at 3 m								
No	Frequency (MHz)	Emission Level (dBuV/m)	Limit (dBuV/m)	Margin (dB)	Antenna Height (m)	Table Angle (Degree)	Raw Value (dBuV)	Correction Factor (dB/m)
1	*5300.00	114.0 PK			1.53 V	283	112.3	1.7
2	*5300.00	104.9 AV			1.53 V	283	103.2	1.7
3	5350.00	56.8 PK	74.0	-17.2	1.53 V	283	54.9	1.9
4	5350.00	40.9 AV	54.0	-13.1	1.53 V	283	39.0	1.9
5	10600.00	48.2 PK	74.0	-25.8	2.16 V	330	36.3	11.9
6	10600.00	37.4 AV	54.0	-16.6	2.16 V	330	25.5	11.9
7	15900.00	56.0 PK	74.0	-18.0	1.92 V	250	44.7	11.3
8	15900.00	43.2 AV	54.0	-10.8	1.92 V	250	31.9	11.3

Remarks:

1. Emission Level(dBuV/m) = Raw Value(dBuV) + Correction Factor(dB/m)
2. Correction Factor(dB/m) = Antenna Factor(dB/m) + Cable Factor(dB) – Pre-Amplifier Factor(dB)
3. Margin value = Emission Level – Limit value
4. The other emission levels were very low against the limit.
5. " * ": Fundamental frequency.

RF Mode	TX 802.11a	Channel	CH 64 : 5320 MHz
Frequency Range	1GHz ~ 40GHz	Detector Function	Peak (PK) Average (AV)

Antenna Polarity & Test Distance : Horizontal at 3 m								
No	Frequency (MHz)	Emission Level (dBuV/m)	Limit (dBuV/m)	Margin (dB)	Antenna Height (m)	Table Angle (Degree)	Raw Value (dBuV)	Correction Factor (dB/m)
1	*5320.00	102.1 PK			1.20 H	119	100.3	1.8
2	*5320.00	92.1 AV			1.20 H	119	90.3	1.8
3	5350.00	60.6 PK	74.0	-13.4	1.20 H	119	58.7	1.9
4	5350.00	44.9 AV	54.0	-9.1	1.20 H	119	43.0	1.9
5	10640.00	45.9 PK	74.0	-28.1	1.68 H	242	34.1	11.8
6	10640.00	35.7 AV	54.0	-18.3	1.68 H	242	23.9	11.8
7	15960.00	54.8 PK	74.0	-19.2	1.29 H	327	43.2	11.6
8	15960.00	42.2 AV	54.0	-11.8	1.29 H	327	30.6	11.6

Antenna Polarity & Test Distance : Vertical at 3 m								
No	Frequency (MHz)	Emission Level (dBuV/m)	Limit (dBuV/m)	Margin (dB)	Antenna Height (m)	Table Angle (Degree)	Raw Value (dBuV)	Correction Factor (dB/m)
1	*5320.00	113.9 PK			1.50 V	275	112.1	1.8
2	*5320.00	104.6 AV			1.50 V	275	102.8	1.8
3	5350.00	70.9 PK	74.0	-3.1	1.50 V	275	69.0	1.9
4	5350.00	52.3 AV	54.0	-1.7	1.50 V	275	50.4	1.9
5	10640.00	48.8 PK	74.0	-25.2	2.15 V	348	37.0	11.8
6	10640.00	37.8 AV	54.0	-16.2	2.15 V	348	26.0	11.8
7	15960.00	55.9 PK	74.0	-18.1	1.92 V	249	44.3	11.6
8	15960.00	42.9 AV	54.0	-11.1	1.92 V	249	31.3	11.6

Remarks:

1. Emission Level(dBuV/m) = Raw Value(dBuV) + Correction Factor(dB/m)
2. Correction Factor(dB/m) = Antenna Factor(dB/m) + Cable Factor(dB) – Pre-Amplifier Factor(dB)
3. Margin value = Emission Level – Limit value
4. The other emission levels were very low against the limit.
5. " * ": Fundamental frequency.

RF Mode	TX 802.11a	Channel	CH 100 : 5500 MHz
Frequency Range	1GHz ~ 40GHz	Detector Function	Peak (PK) Average (AV)

Antenna Polarity & Test Distance : Horizontal at 3 m

No	Frequency (MHz)	Emission Level (dBuV/m)	Limit (dBuV/m)	Margin (dB)	Antenna Height (m)	Table Angle (Degree)	Raw Value (dBuV)	Correction Factor (dB/m)
1	5460.00	49.8 PK	74.0	-24.2	1.40 H	167	47.7	2.1
2	5460.00	37.9 AV	54.0	-16.1	1.40 H	167	35.8	2.1
3	#5465.90	53.4 PK	68.2	-14.8	1.40 H	167	51.3	2.1
4	*5500.00	98.5 PK			1.40 H	167	96.4	2.1
5	*5500.00	90.0 AV			1.40 H	167	87.9	2.1
6	11000.00	45.9 PK	74.0	-28.1	1.65 H	225	33.5	12.4
7	11000.00	35.4 AV	54.0	-18.6	1.65 H	225	23.0	12.4
8	#16500.00	54.5 PK	68.2	-13.7	1.32 H	301	40.8	13.7

Antenna Polarity & Test Distance : Vertical at 3 m

No	Frequency (MHz)	Emission Level (dBuV/m)	Limit (dBuV/m)	Margin (dB)	Antenna Height (m)	Table Angle (Degree)	Raw Value (dBuV)	Correction Factor (dB/m)
1	5458.80	59.9 PK	74.0	-14.1	1.40 V	276	57.8	2.1
2	5458.80	43.0 AV	54.0	-11.0	1.40 V	276	40.9	2.1
3	5460.00	56.4 PK	74.0	-17.6	1.40 V	276	54.3	2.1
4	5460.00	44.5 AV	54.0	-9.5	1.40 V	276	42.4	2.1
5	#5470.00	66.5 PK	68.2	-1.7	1.40 V	276	64.3	2.2
6	*5500.00	112.6 PK			1.40 V	276	110.5	2.1
7	*5500.00	103.7 AV			1.40 V	276	101.6	2.1
8	11000.00	48.7 PK	74.0	-25.3	2.14 V	333	36.3	12.4
9	11000.00	37.9 AV	54.0	-16.1	2.14 V	333	25.5	12.4
10	#16500.00	56.7 PK	68.2	-11.5	2.00 V	269	43.0	13.7

Remarks:

1. Emission Level(dBuV/m) = Raw Value(dBuV) + Correction Factor(dB/m)
2. Correction Factor(dB/m) = Antenna Factor(dB/m) + Cable Factor(dB) – Pre-Amplifier Factor(dB)
3. Margin value = Emission Level – Limit value
4. The other emission levels were very low against the limit.
5. " * ": Fundamental frequency.
6. " # ": The radiated frequency is out of the restricted band.

RF Mode	TX 802.11a	Channel	CH 116 : 5580 MHz
Frequency Range	1GHz ~ 40GHz	Detector Function	Peak (PK) Average (AV)

Antenna Polarity & Test Distance : Horizontal at 3 m								
No	Frequency (MHz)	Emission Level (dBuV/m)	Limit (dBuV/m)	Margin (dB)	Antenna Height (m)	Table Angle (Degree)	Raw Value (dBuV)	Correction Factor (dB/m)
1	5460.00	49.5 PK	74.0	-24.5	1.37 H	179	47.4	2.1
2	5460.00	36.8 AV	54.0	-17.2	1.37 H	179	34.7	2.1
3	#5470.00	52.8 PK	68.2	-15.4	1.37 H	179	50.6	2.2
4	*5580.00	100.3 PK			1.37 H	179	98.2	2.1
5	*5580.00	91.5 AV			1.37 H	179	89.4	2.1
6	11160.00	46.8 PK	74.0	-27.2	1.60 H	232	34.8	12.0
7	11160.00	36.2 AV	54.0	-17.8	1.60 H	232	24.2	12.0
8	#16740.00	55.0 PK	68.2	-13.2	1.24 H	315	39.7	15.3

Antenna Polarity & Test Distance : Vertical at 3 m								
No	Frequency (MHz)	Emission Level (dBuV/m)	Limit (dBuV/m)	Margin (dB)	Antenna Height (m)	Table Angle (Degree)	Raw Value (dBuV)	Correction Factor (dB/m)
1	5460.00	49.8 PK	74.0	-24.2	1.58 V	300	47.7	2.1
2	5460.00	37.8 AV	54.0	-16.2	1.58 V	300	35.7	2.1
3	#5470.00	53.1 PK	68.2	-15.1	1.58 V	300	50.9	2.2
4	*5580.00	113.6 PK			1.58 V	300	111.5	2.1
5	*5580.00	104.9 AV			1.58 V	300	102.8	2.1
6	11160.00	48.3 PK	74.0	-25.7	2.21 V	348	36.3	12.0
7	11160.00	37.8 AV	54.0	-16.2	2.21 V	348	25.8	12.0
8	#16740.00	55.8 PK	68.2	-12.4	1.99 V	259	40.5	15.3

Remarks:

1. Emission Level(dBuV/m) = Raw Value(dBuV) + Correction Factor(dB/m)
2. Correction Factor(dB/m) = Antenna Factor(dB/m) + Cable Factor(dB) – Pre-Amplifier Factor(dB)
3. Margin value = Emission Level – Limit value
4. The other emission levels were very low against the limit.
5. " * ": Fundamental frequency.
6. " # ": The radiated frequency is out of the restricted band.

RF Mode	TX 802.11a	Channel	CH 140 : 5700 MHz
Frequency Range	1GHz ~ 40GHz	Detector Function	Peak (PK) Average (AV)

Antenna Polarity & Test Distance : Horizontal at 3 m

No	Frequency (MHz)	Emission Level (dBuV/m)	Limit (dBuV/m)	Margin (dB)	Antenna Height (m)	Table Angle (Degree)	Raw Value (dBuV)	Correction Factor (dB/m)
1	*5700.00	97.6 PK			1.34 H	191	95.3	2.3
2	*5700.00	88.4 AV			1.34 H	191	86.1	2.3
3	#5725.00	56.8 PK	68.2	-11.4	1.34 H	191	54.4	2.4
4	11400.00	46.4 PK	74.0	-27.6	1.65 H	229	33.9	12.5
5	11400.00	36.0 AV	54.0	-18.0	1.65 H	229	23.5	12.5
6	#17100.00	55.0 PK	68.2	-13.2	1.27 H	332	38.2	16.8

Antenna Polarity & Test Distance : Vertical at 3 m

No	Frequency (MHz)	Emission Level (dBuV/m)	Limit (dBuV/m)	Margin (dB)	Antenna Height (m)	Table Angle (Degree)	Raw Value (dBuV)	Correction Factor (dB/m)
1	*5700.00	112.1 PK			1.42 V	277	109.8	2.3
2	*5700.00	103.1 AV			1.42 V	277	100.8	2.3
3	#5725.00	66.5 PK	68.2	-1.7	1.42 V	277	64.1	2.4
4	11400.00	48.0 PK	74.0	-26.0	2.20 V	343	35.5	12.5
5	11400.00	37.5 AV	54.0	-16.5	2.20 V	343	25.0	12.5
6	#17100.00	56.1 PK	68.2	-12.1	1.92 V	239	39.3	16.8

Remarks:

1. Emission Level(dBuV/m) = Raw Value(dBuV) + Correction Factor(dB/m)
2. Correction Factor(dB/m) = Antenna Factor(dB/m) + Cable Factor(dB) – Pre-Amplifier Factor(dB)
3. Margin value = Emission Level – Limit value
4. The other emission levels were very low against the limit.
5. " * ": Fundamental frequency.
6. " # ": The radiated frequency is out of the restricted band.

RF Mode	TX 802.11a	Channel	CH 144 : 5720 MHz
Frequency Range	1GHz ~ 40GHz	Detector Function	Peak (PK) Average (AV)

Antenna Polarity & Test Distance : Horizontal at 3 m

No	Frequency (MHz)	Emission Level (dBuV/m)	Limit (dBuV/m)	Margin (dB)	Antenna Height (m)	Table Angle (Degree)	Raw Value (dBuV)	Correction Factor (dB/m)
1	5460.00	50.2 PK	74.0	-23.8	1.32 H	191	48.1	2.1
2	5460.00	37.8 AV	54.0	-16.2	1.32 H	191	35.7	2.1
3	#5470.00	50.4 PK	68.2	-17.8	1.32 H	191	48.2	2.2
4	*5720.00	99.6 PK			1.32 H	191	97.2	2.4
5	*5720.00	91.8 AV			1.32 H	191	89.4	2.4
6	#5850.00	50.5 PK	68.2	-17.7	1.32 H	191	47.8	2.7
7	11440.00	45.6 PK	74.0	-28.4	1.68 H	223	33.2	12.4
8	11440.00	35.4 AV	54.0	-18.6	1.68 H	223	23.0	12.4
9	#17160.00	54.2 PK	68.2	-14.0	1.30 H	312	37.6	16.6

Antenna Polarity & Test Distance : Vertical at 3 m

No	Frequency (MHz)	Emission Level (dBuV/m)	Limit (dBuV/m)	Margin (dB)	Antenna Height (m)	Table Angle (Degree)	Raw Value (dBuV)	Correction Factor (dB/m)
1	5460.00	50.3 PK	74.0	-23.7	1.52 V	292	48.2	2.1
2	5460.00	38.1 AV	54.0	-15.9	1.52 V	292	36.0	2.1
3	#5470.00	51.1 PK	68.2	-17.1	1.52 V	292	48.9	2.2
4	*5720.00	114.2 PK			1.52 V	292	111.8	2.4
5	*5720.00	105.2 AV			1.52 V	292	102.8	2.4
6	#5850.00	50.8 PK	68.2	-17.4	1.52 V	292	48.1	2.7
7	11440.00	49.1 PK	74.0	-24.9	2.16 V	330	36.7	12.4
8	11440.00	38.0 AV	54.0	-16.0	2.16 V	330	25.6	12.4
9	#17160.00	56.0 PK	68.2	-12.2	1.93 V	243	39.4	16.6

Remarks:

1. Emission Level(dBuV/m) = Raw Value(dBuV) + Correction Factor(dB/m)
2. Correction Factor(dB/m) = Antenna Factor(dB/m) + Cable Factor(dB) – Pre-Amplifier Factor(dB)
3. Margin value = Emission Level – Limit value
4. The other emission levels were very low against the limit.
5. " * ": Fundamental frequency.
6. " # ": The radiated frequency is out of the restricted band.

RF Mode	TX 802.11a	Channel	CH 149 : 5745 MHz
Frequency Range	1GHz ~ 40GHz	Detector Function	Peak (PK) Average (AV)

Antenna Polarity & Test Distance : Horizontal at 3 m								
No	Frequency (MHz)	Emission Level (dBuV/m)	Limit (dBuV/m)	Margin (dB)	Antenna Height (m)	Table Angle (Degree)	Raw Value (dBuV)	Correction Factor (dB/m)
1	#5609.35	50.9 PK	68.2	-17.3	2.60 H	141	48.8	2.1
2	*5745.00	101.8 PK			2.60 H	141	99.4	2.4
3	*5745.00	92.7 AV			2.60 H	141	90.3	2.4
4	#5951.86	51.8 PK	68.2	-16.4	2.60 H	141	48.9	2.9
5	11490.00	46.1 PK	74.0	-27.9	1.67 H	247	33.5	12.6
6	11490.00	35.6 AV	54.0	-18.4	1.67 H	247	23.0	12.6
7	#17235.00	54.8 PK	68.2	-13.4	1.25 H	327	38.0	16.8

Antenna Polarity & Test Distance : Vertical at 3 m								
No	Frequency (MHz)	Emission Level (dBuV/m)	Limit (dBuV/m)	Margin (dB)	Antenna Height (m)	Table Angle (Degree)	Raw Value (dBuV)	Correction Factor (dB/m)
1	#5643.33	51.8 PK	68.2	-16.4	1.51 V	276	49.5	2.3
2	*5745.00	115.2 PK			1.51 V	276	112.8	2.4
3	*5745.00	105.7 AV			1.51 V	276	103.3	2.4
4	#6000.80	51.4 PK	68.2	-16.8	1.51 V	276	48.5	2.9
5	11490.00	48.7 PK	74.0	-25.3	2.11 V	327	36.1	12.6
6	11490.00	38.1 AV	54.0	-15.9	2.11 V	327	25.5	12.6
7	#17235.00	56.6 PK	68.2	-11.6	1.97 V	244	39.8	16.8

Remarks:

1. Emission Level(dBuV/m) = Raw Value(dBuV) + Correction Factor(dB/m)
2. Correction Factor(dB/m) = Antenna Factor(dB/m) + Cable Factor(dB) – Pre-Amplifier Factor(dB)
3. Margin value = Emission Level – Limit value
4. The other emission levels were very low against the limit.
5. " * ": Fundamental frequency.
6. " # ": The radiated frequency is out of the restricted band.

RF Mode	TX 802.11a	Channel	CH 157 : 5785 MHz
Frequency Range	1GHz ~ 40GHz	Detector Function	Peak (PK) Average (AV)

Antenna Polarity & Test Distance : Horizontal at 3 m

No	Frequency (MHz)	Emission Level (dBuV/m)	Limit (dBuV/m)	Margin (dB)	Antenna Height (m)	Table Angle (Degree)	Raw Value (dBuV)	Correction Factor (dB/m)
1	#5575.03	50.2 PK	68.2	-18.0	2.56 H	137	48.1	2.1
2	*5785.00	102.1 PK			2.56 H	137	99.5	2.6
3	*5785.00	92.9 AV			2.56 H	137	90.3	2.6
4	#5937.01	50.1 PK	68.2	-18.1	2.56 H	137	47.2	2.9
5	11570.00	46.1 PK	74.0	-27.9	1.63 H	237	33.5	12.6
6	11570.00	35.8 AV	54.0	-18.2	1.63 H	237	23.2	12.6
7	#17355.00	54.7 PK	68.2	-13.5	1.28 H	317	37.0	17.7

Antenna Polarity & Test Distance : Vertical at 3 m

No	Frequency (MHz)	Emission Level (dBuV/m)	Limit (dBuV/m)	Margin (dB)	Antenna Height (m)	Table Angle (Degree)	Raw Value (dBuV)	Correction Factor (dB/m)
1	#5553.79	51.4 PK	68.2	-16.8	1.54 V	270	49.3	2.1
2	*5785.00	114.8 PK			1.54 V	270	112.2	2.6
3	*5785.00	105.5 AV			1.54 V	270	102.9	2.6
4	#5946.90	52.0 PK	68.2	-16.2	1.54 V	270	49.1	2.9
5	11570.00	48.7 PK	74.0	-25.3	2.13 V	348	36.1	12.6
6	11570.00	37.6 AV	54.0	-16.4	2.13 V	348	25.0	12.6
7	#17355.00	56.2 PK	68.2	-12.0	1.93 V	252	38.5	17.7

Remarks:

1. Emission Level(dBuV/m) = Raw Value(dBuV) + Correction Factor(dB/m)
2. Correction Factor(dB/m) = Antenna Factor(dB/m) + Cable Factor(dB) – Pre-Amplifier Factor(dB)
3. Margin value = Emission Level – Limit value
4. The other emission levels were very low against the limit.
5. " * ": Fundamental frequency.
6. " # ": The radiated frequency is out of the restricted band.

RF Mode	TX 802.11a	Channel	CH 165 : 5825 MHz
Frequency Range	1GHz ~ 40GHz	Detector Function	Peak (PK) Average (AV)

Antenna Polarity & Test Distance : Horizontal at 3 m								
No	Frequency (MHz)	Emission Level (dBuV/m)	Limit (dBuV/m)	Margin (dB)	Antenna Height (m)	Table Angle (Degree)	Raw Value (dBuV)	Correction Factor (dB/m)
1	#5634.19	49.6 PK	68.2	-18.6	2.52 H	132	47.3	2.3
2	*5825.00	102.3 PK			2.52 H	132	99.7	2.6
3	*5825.00	93.1 AV			2.52 H	132	90.5	2.6
4	#6000.87	51.0 PK	68.2	-17.2	2.52 H	132	48.1	2.9
5	11650.00	46.1 PK	74.0	-27.9	1.59 H	239	33.9	12.2
6	11650.00	35.7 AV	54.0	-18.3	1.59 H	239	23.5	12.2
7	#17475.00	54.2 PK	68.2	-14.0	1.27 H	320	35.5	18.7

Antenna Polarity & Test Distance : Vertical at 3 m								
No	Frequency (MHz)	Emission Level (dBuV/m)	Limit (dBuV/m)	Margin (dB)	Antenna Height (m)	Table Angle (Degree)	Raw Value (dBuV)	Correction Factor (dB/m)
1	#5571.51	51.4 PK	68.2	-16.8	1.52 V	273	49.3	2.1
2	*5825.00	115.3 PK			1.52 V	273	112.7	2.6
3	*5825.00	105.9 AV			1.52 V	273	103.3	2.6
4	#5925.94	54.5 PK	68.2	-13.7	1.52 V	273	51.6	2.9
5	11650.00	48.3 PK	74.0	-25.7	2.21 V	327	36.1	12.2
6	11650.00	37.5 AV	54.0	-16.5	2.21 V	327	25.3	12.2
7	#17475.00	55.8 PK	68.2	-12.4	1.91 V	261	37.1	18.7

Remarks:

1. Emission Level(dBuV/m) = Raw Value(dBuV) + Correction Factor(dB/m)
2. Correction Factor(dB/m) = Antenna Factor(dB/m) + Cable Factor(dB) – Pre-Amplifier Factor(dB)
3. Margin value = Emission Level – Limit value
4. The other emission levels were very low against the limit.
5. " * ": Fundamental frequency.
6. " # ": The radiated frequency is out of the restricted band.

RF Mode	TX 802.11ax (HE20)	Channel	CH 36 : 5180 MHz
Frequency Range	1GHz ~ 40GHz	Detector Function	Peak (PK) Average (AV)

Antenna Polarity & Test Distance : Horizontal at 3 m								
No	Frequency (MHz)	Emission Level (dBuV/m)	Limit (dBuV/m)	Margin (dB)	Antenna Height (m)	Table Angle (Degree)	Raw Value (dBuV)	Correction Factor (dB/m)
1	5150.00	58.3 PK	74.0	-15.7	1.05 H	115	56.0	2.3
2	5150.00	44.4 AV	54.0	-9.6	1.05 H	115	42.1	2.3
3	*5180.00	103.8 PK			1.05 H	115	101.6	2.2
4	*5180.00	92.8 AV			1.05 H	115	90.6	2.2
5	#10360.00	46.2 PK	68.2	-22.0	1.65 H	235	34.4	11.8
6	15540.00	54.7 PK	74.0	-19.3	1.34 H	318	42.9	11.8
7	15540.00	41.9 AV	54.0	-12.1	1.34 H	318	30.1	11.8
Antenna Polarity & Test Distance : Vertical at 3 m								
No	Frequency (MHz)	Emission Level (dBuV/m)	Limit (dBuV/m)	Margin (dB)	Antenna Height (m)	Table Angle (Degree)	Raw Value (dBuV)	Correction Factor (dB/m)
1	5150.00	70.0 PK	74.0	-4.0	1.55 V	283	67.7	2.3
2	5150.00	52.3 AV	54.0	-1.7	1.55 V	283	50.0	2.3
3	*5180.00	115.3 PK			1.55 V	283	113.1	2.2
4	*5180.00	104.2 AV			1.55 V	283	102.0	2.2
5	#10360.00	48.4 PK	68.2	-19.8	2.11 V	342	36.6	11.8
6	15540.00	56.5 PK	74.0	-17.5	1.99 V	246	44.7	11.8
7	15540.00	43.3 AV	54.0	-10.7	1.99 V	246	31.5	11.8

Remarks:

1. Emission Level(dBuV/m) = Raw Value(dBuV) + Correction Factor(dB/m)
2. Correction Factor(dB/m) = Antenna Factor(dB/m) + Cable Factor(dB) – Pre-Amplifier Factor(dB)
3. Margin value = Emission Level – Limit value
4. The other emission levels were very low against the limit.
5. " * ": Fundamental frequency.
6. " # ": The radiated frequency is out of the restricted band.

RF Mode	TX 802.11ax (HE20)	Channel	CH 40 : 5200 MHz
Frequency Range	1GHz ~ 40GHz	Detector Function	Peak (PK) Average (AV)

Antenna Polarity & Test Distance : Horizontal at 3 m

No	Frequency (MHz)	Emission Level (dBuV/m)	Limit (dBuV/m)	Margin (dB)	Antenna Height (m)	Table Angle (Degree)	Raw Value (dBuV)	Correction Factor (dB/m)
1	5150.00	56.2 PK	74.0	-17.8	1.06 H	119	53.9	2.3
2	5150.00	40.4 AV	54.0	-13.6	1.06 H	119	38.1	2.3
3	*5200.00	104.9 PK			1.06 H	119	102.8	2.1
4	*5200.00	93.8 AV			1.06 H	119	91.7	2.1
5	#10400.00	46.4 PK	68.2	-21.8	1.59 H	245	34.4	12.0
6	15600.00	55.1 PK	74.0	-18.9	1.25 H	303	43.6	11.5
7	15600.00	41.9 AV	54.0	-12.1	1.25 H	303	30.4	11.5

Antenna Polarity & Test Distance : Vertical at 3 m

No	Frequency (MHz)	Emission Level (dBuV/m)	Limit (dBuV/m)	Margin (dB)	Antenna Height (m)	Table Angle (Degree)	Raw Value (dBuV)	Correction Factor (dB/m)
1	5150.00	57.9 PK	74.0	-16.1	1.51 V	281	55.6	2.3
2	5150.00	41.6 AV	54.0	-12.4	1.51 V	281	39.3	2.3
3	*5200.00	115.5 PK			1.51 V	281	113.4	2.1
4	*5200.00	104.6 AV			1.51 V	281	102.5	2.1
5	#10400.00	48.2 PK	68.2	-20.0	2.22 V	342	36.2	12.0
6	15600.00	55.7 PK	74.0	-18.3	1.92 V	263	44.2	11.5
7	15600.00	42.8 AV	54.0	-11.2	1.92 V	263	31.3	11.5

Remarks:

1. Emission Level(dBuV/m) = Raw Value(dBuV) + Correction Factor(dB/m)
2. Correction Factor(dB/m) = Antenna Factor(dB/m) + Cable Factor(dB) – Pre-Amplifier Factor(dB)
3. Margin value = Emission Level – Limit value
4. The other emission levels were very low against the limit.
5. " * ": Fundamental frequency.
6. " # ": The radiated frequency is out of the restricted band.

RF Mode	TX 802.11ax (HE20)	Channel	CH 48 : 5240 MHz
Frequency Range	1GHz ~ 40GHz	Detector Function	Peak (PK) Average (AV)

Antenna Polarity & Test Distance : Horizontal at 3 m

No	Frequency (MHz)	Emission Level (dBuV/m)	Limit (dBuV/m)	Margin (dB)	Antenna Height (m)	Table Angle (Degree)	Raw Value (dBuV)	Correction Factor (dB/m)
1	5150.00	51.0 PK	74.0	-23.0	1.08 H	104	48.7	2.3
2	5150.00	38.8 AV	54.0	-15.2	1.08 H	104	36.5	2.3
3	*5240.00	103.3 PK			1.08 H	104	101.3	2.0
4	*5240.00	92.2 AV			1.08 H	104	90.2	2.0
5	5350.00	50.1 PK	74.0	-23.9	1.08 H	104	48.2	1.9
6	5350.00	38.1 AV	54.0	-15.9	1.08 H	104	36.2	1.9
7	#10480.00	46.1 PK	68.2	-22.1	1.64 H	248	34.2	11.9
8	15720.00	54.9 PK	74.0	-19.1	1.28 H	303	43.1	11.8
9	15720.00	41.9 AV	54.0	-12.1	1.28 H	303	30.1	11.8

Antenna Polarity & Test Distance : Vertical at 3 m

No	Frequency (MHz)	Emission Level (dBuV/m)	Limit (dBuV/m)	Margin (dB)	Antenna Height (m)	Table Angle (Degree)	Raw Value (dBuV)	Correction Factor (dB/m)
1	5150.00	51.2 PK	74.0	-22.8	1.46 V	285	48.9	2.3
2	5150.00	39.0 AV	54.0	-15.0	1.46 V	285	36.7	2.3
3	*5240.00	115.6 PK			1.46 V	285	113.6	2.0
4	*5240.00	104.5 AV			1.46 V	285	102.5	2.0
5	5350.00	50.3 PK	74.0	-23.7	1.46 V	285	48.4	1.9
6	5350.00	38.4 AV	54.0	-15.6	1.46 V	285	36.5	1.9
7	#10480.00	49.2 PK	68.2	-19.0	2.13 V	340	37.3	11.9
8	15720.00	56.2 PK	74.0	-17.8	1.93 V	266	44.4	11.8
9	15720.00	43.3 AV	54.0	-10.7	1.93 V	266	31.5	11.8

Remarks:

1. Emission Level(dBuV/m) = Raw Value(dBuV) + Correction Factor(dB/m)
2. Correction Factor(dB/m) = Antenna Factor(dB/m) + Cable Factor(dB) – Pre-Amplifier Factor(dB)
3. Margin value = Emission Level – Limit value
4. The other emission levels were very low against the limit.
5. " * ": Fundamental frequency.
6. " # ": The radiated frequency is out of the restricted band.

RF Mode	TX 802.11ax (HE20)	Channel	CH 52 : 5260 MHz
Frequency Range	1GHz ~ 40GHz	Detector Function	Peak (PK) Average (AV)

Antenna Polarity & Test Distance : Horizontal at 3 m

No	Frequency (MHz)	Emission Level (dBuV/m)	Limit (dBuV/m)	Margin (dB)	Antenna Height (m)	Table Angle (Degree)	Raw Value (dBuV)	Correction Factor (dB/m)
1	5150.00	50.3 PK	74.0	-23.7	1.09 H	115	48.0	2.3
2	5150.00	38.0 AV	54.0	-16.0	1.09 H	115	35.7	2.3
3	*5260.00	103.5 PK			1.09 H	115	101.5	2.0
4	*5260.00	92.6 AV			1.09 H	115	90.6	2.0
5	5350.00	50.9 PK	74.0	-23.1	1.09 H	115	49.0	1.9
6	5350.00	38.8 AV	54.0	-15.2	1.09 H	115	36.9	1.9
7	#10520.00	45.7 PK	68.2	-22.5	1.63 H	227	33.7	12.0
8	15780.00	55.4 PK	74.0	-18.6	1.25 H	331	43.9	11.5
9	15780.00	42.2 AV	54.0	-11.8	1.25 H	331	30.7	11.5

Antenna Polarity & Test Distance : Vertical at 3 m

No	Frequency (MHz)	Emission Level (dBuV/m)	Limit (dBuV/m)	Margin (dB)	Antenna Height (m)	Table Angle (Degree)	Raw Value (dBuV)	Correction Factor (dB/m)
1	5150.00	50.4 PK	74.0	-23.6	1.51 V	271	48.1	2.3
2	5150.00	38.2 AV	54.0	-15.8	1.51 V	271	35.9	2.3
3	*5260.00	115.9 PK			1.51 V	271	113.9	2.0
4	*5260.00	104.9 AV			1.51 V	271	102.9	2.0
5	5350.00	51.2 PK	74.0	-22.8	1.51 V	271	49.3	1.9
6	5350.00	39.2 AV	54.0	-14.8	1.51 V	271	37.3	1.9
7	#10520.00	48.3 PK	68.2	-19.9	2.13 V	337	36.3	12.0
8	15780.00	56.9 PK	74.0	-17.1	1.94 V	261	45.4	11.5
9	15780.00	43.6 AV	54.0	-10.4	1.94 V	261	32.1	11.5

Remarks:

1. Emission Level(dBuV/m) = Raw Value(dBuV) + Correction Factor(dB/m)
2. Correction Factor(dB/m) = Antenna Factor(dB/m) + Cable Factor(dB) – Pre-Amplifier Factor(dB)
3. Margin value = Emission Level – Limit value
4. The other emission levels were very low against the limit.
5. " * ": Fundamental frequency.
6. " # ": The radiated frequency is out of the restricted band.

RF Mode	TX 802.11ax (HE20)	Channel	CH 60 : 5300 MHz
Frequency Range	1GHz ~ 40GHz	Detector Function	Peak (PK) Average (AV)

Antenna Polarity & Test Distance : Horizontal at 3 m

No	Frequency (MHz)	Emission Level (dBuV/m)	Limit (dBuV/m)	Margin (dB)	Antenna Height (m)	Table Angle (Degree)	Raw Value (dBuV)	Correction Factor (dB/m)
1	*5300.00	103.8 PK			1.11 H	102	102.1	1.7
2	*5300.00	92.9 AV			1.11 H	102	91.2	1.7
3	5350.00	58.0 PK	74.0	-16.0	1.11 H	102	56.1	1.9
4	5350.00	41.3 AV	54.0	-12.7	1.11 H	102	39.4	1.9
5	10600.00	46.4 PK	74.0	-27.6	1.64 H	236	34.5	11.9
6	10600.00	36.0 AV	54.0	-18.0	1.64 H	236	24.1	11.9
7	15900.00	54.6 PK	74.0	-19.4	1.26 H	319	43.3	11.3
8	15900.00	41.7 AV	54.0	-12.3	1.26 H	319	30.4	11.3

Antenna Polarity & Test Distance : Vertical at 3 m

No	Frequency (MHz)	Emission Level (dBuV/m)	Limit (dBuV/m)	Margin (dB)	Antenna Height (m)	Table Angle (Degree)	Raw Value (dBuV)	Correction Factor (dB/m)
1	*5300.00	115.7 PK			1.55 V	287	114.0	1.7
2	*5300.00	104.8 AV			1.55 V	287	103.1	1.7
3	5350.00	58.4 PK	74.0	-15.6	1.55 V	287	56.5	1.9
4	5350.00	41.9 AV	54.0	-12.1	1.55 V	287	40.0	1.9
5	10600.00	48.3 PK	74.0	-25.7	2.13 V	348	36.4	11.9
6	10600.00	37.7 AV	54.0	-16.3	2.13 V	348	25.8	11.9
7	15900.00	56.5 PK	74.0	-17.5	2.00 V	268	45.2	11.3
8	15900.00	43.2 AV	54.0	-10.8	2.00 V	268	31.9	11.3

Remarks:

1. Emission Level(dBuV/m) = Raw Value(dBuV) + Correction Factor(dB/m)
2. Correction Factor(dB/m) = Antenna Factor(dB/m) + Cable Factor(dB) – Pre-Amplifier Factor(dB)
3. Margin value = Emission Level – Limit value
4. The other emission levels were very low against the limit.
5. " * ": Fundamental frequency.

RF Mode	TX 802.11ax (HE20)	Channel	CH 64 : 5320 MHz
Frequency Range	1GHz ~ 40GHz	Detector Function	Peak (PK) Average (AV)

Antenna Polarity & Test Distance : Horizontal at 3 m								
No	Frequency (MHz)	Emission Level (dBuV/m)	Limit (dBuV/m)	Margin (dB)	Antenna Height (m)	Table Angle (Degree)	Raw Value (dBuV)	Correction Factor (dB/m)
1	*5320.00	103.5 PK			1.15 H	109	101.7	1.8
2	*5320.00	91.8 AV			1.15 H	109	90.0	1.8
3	5350.00	58.5 PK	74.0	-15.5	1.15 H	109	56.6	1.9
4	5350.00	45.1 AV	54.0	-8.9	1.15 H	109	43.2	1.9
5	10640.00	46.5 PK	74.0	-27.5	1.67 H	247	34.7	11.8
6	10640.00	36.2 AV	54.0	-17.8	1.67 H	247	24.4	11.8
7	15960.00	54.2 PK	74.0	-19.8	1.26 H	304	42.6	11.6
8	15960.00	41.3 AV	54.0	-12.7	1.26 H	304	29.7	11.6

Antenna Polarity & Test Distance : Vertical at 3 m								
No	Frequency (MHz)	Emission Level (dBuV/m)	Limit (dBuV/m)	Margin (dB)	Antenna Height (m)	Table Angle (Degree)	Raw Value (dBuV)	Correction Factor (dB/m)
1	*5320.00	115.5 PK			1.47 V	279	113.7	1.8
2	*5320.00	104.1 AV			1.47 V	279	102.3	1.8
3	5350.00	70.2 PK	74.0	-3.8	1.47 V	279	68.3	1.9
4	5350.00	52.2 AV	54.0	-1.8	1.47 V	279	50.3	1.9
5	10640.00	48.6 PK	74.0	-25.4	2.15 V	342	36.8	11.8
6	10640.00	37.7 AV	54.0	-16.3	2.15 V	342	25.9	11.8
7	15960.00	56.1 PK	74.0	-17.9	1.99 V	260	44.5	11.6
8	15960.00	43.3 AV	54.0	-10.7	1.99 V	260	31.7	11.6

Remarks:

1. Emission Level(dBuV/m) = Raw Value(dBuV) + Correction Factor(dB/m)
2. Correction Factor(dB/m) = Antenna Factor(dB/m) + Cable Factor(dB) – Pre-Amplifier Factor(dB)
3. Margin value = Emission Level – Limit value
4. The other emission levels were very low against the limit.
5. " * ": Fundamental frequency.

RF Mode	TX 802.11ax (HE20)	Channel	CH 100 : 5500 MHz
Frequency Range	1GHz ~ 40GHz	Detector Function	Peak (PK) Average (AV)

Antenna Polarity & Test Distance : Horizontal at 3 m

No	Frequency (MHz)	Emission Level (dBuV/m)	Limit (dBuV/m)	Margin (dB)	Antenna Height (m)	Table Angle (Degree)	Raw Value (dBuV)	Correction Factor (dB/m)
1	5460.00	50.0 PK	74.0	-24.0	1.37 H	160	47.9	2.1
2	5460.00	37.9 AV	54.0	-16.1	1.37 H	160	35.8	2.1
3	#5470.00	52.3 PK	68.2	-15.9	1.00 H	0	50.1	2.2
4	*5500.00	101.6 PK			1.37 H	160	99.5	2.1
5	*5500.00	89.7 AV			1.37 H	160	87.6	2.1
6	11000.00	46.6 PK	74.0	-27.4	1.65 H	241	34.2	12.4
7	11000.00	36.1 AV	54.0	-17.9	1.65 H	241	23.7	12.4
8	#16500.00	55.0 PK	68.2	-13.2	1.28 H	319	41.3	13.7

Antenna Polarity & Test Distance : Vertical at 3 m

No	Frequency (MHz)	Emission Level (dBuV/m)	Limit (dBuV/m)	Margin (dB)	Antenna Height (m)	Table Angle (Degree)	Raw Value (dBuV)	Correction Factor (dB/m)
1	5460.00	59.8 PK	74.0	-14.2	1.42 V	280	57.7	2.1
2	5460.00	44.3 AV	54.0	-9.7	1.42 V	280	42.2	2.1
3	#5470.00	66.4 PK	68.2	-1.8	1.42 V	280	64.2	2.2
4	*5500.00	114.3 PK			1.42 V	280	112.2	2.1
5	*5500.00	103.4 AV			1.42 V	280	101.3	2.1
6	11000.00	48.3 PK	74.0	-25.7	2.12 V	324	35.9	12.4
7	11000.00	37.4 AV	54.0	-16.6	2.12 V	324	25.0	12.4
8	#16500.00	56.6 PK	68.2	-11.6	2.00 V	261	42.9	13.7

Remarks:

1. Emission Level(dBuV/m) = Raw Value(dBuV) + Correction Factor(dB/m)
2. Correction Factor(dB/m) = Antenna Factor(dB/m) + Cable Factor(dB) – Pre-Amplifier Factor(dB)
3. Margin value = Emission Level – Limit value
4. The other emission levels were very low against the limit.
5. " * ": Fundamental frequency.
6. " # ": The radiated frequency is out of the restricted band.

RF Mode	TX 802.11ax (HE20)	Channel	CH 116 : 5580 MHz
Frequency Range	1GHz ~ 40GHz	Detector Function	Peak (PK) Average (AV)

Antenna Polarity & Test Distance : Horizontal at 3 m

No	Frequency (MHz)	Emission Level (dBuV/m)	Limit (dBuV/m)	Margin (dB)	Antenna Height (m)	Table Angle (Degree)	Raw Value (dBuV)	Correction Factor (dB/m)
1	5460.00	48.3 PK	74.0	-25.7	1.38 H	161	46.2	2.1
2	5460.00	36.9 AV	54.0	-17.1	1.38 H	161	34.8	2.1
3	#5470.00	52.9 PK	68.2	-15.3	1.38 H	161	50.7	2.2
4	*5580.00	103.5 PK			1.38 H	161	101.4	2.1
5	*5580.00	92.0 AV			1.38 H	161	89.9	2.1
6	11160.00	45.5 PK	74.0	-28.5	1.63 H	222	33.5	12.0
7	11160.00	35.3 AV	54.0	-18.7	1.63 H	222	23.3	12.0
8	#16740.00	53.9 PK	68.2	-14.3	1.31 H	304	38.6	15.3

Antenna Polarity & Test Distance : Vertical at 3 m

No	Frequency (MHz)	Emission Level (dBuV/m)	Limit (dBuV/m)	Margin (dB)	Antenna Height (m)	Table Angle (Degree)	Raw Value (dBuV)	Correction Factor (dB/m)
1	5460.00	49.8 PK	74.0	-24.2	1.52 V	296	47.7	2.1
2	5460.00	37.5 AV	54.0	-16.5	1.52 V	296	35.4	2.1
3	#5470.00	53.8 PK	68.2	-14.4	1.52 V	296	51.6	2.2
4	*5580.00	115.4 PK			1.52 V	296	113.3	2.1
5	*5580.00	104.4 AV			1.52 V	296	102.3	2.1
6	11160.00	48.0 PK	74.0	-26.0	2.14 V	336	36.0	12.0
7	11160.00	37.3 AV	54.0	-16.7	2.14 V	336	25.3	12.0
8	#16740.00	56.3 PK	68.2	-11.9	1.98 V	253	41.0	15.3

Remarks:

1. Emission Level(dBuV/m) = Raw Value(dBuV) + Correction Factor(dB/m)
2. Correction Factor(dB/m) = Antenna Factor(dB/m) + Cable Factor(dB) – Pre-Amplifier Factor(dB)
3. Margin value = Emission Level – Limit value
4. The other emission levels were very low against the limit.
5. " * ": Fundamental frequency.
6. " # ": The radiated frequency is out of the restricted band.

RF Mode	TX 802.11ax (HE20)	Channel	CH 140 : 5700 MHz
Frequency Range	1GHz ~ 40GHz	Detector Function	Peak (PK) Average (AV)

Antenna Polarity & Test Distance : Horizontal at 3 m

No	Frequency (MHz)	Emission Level (dBuV/m)	Limit (dBuV/m)	Margin (dB)	Antenna Height (m)	Table Angle (Degree)	Raw Value (dBuV)	Correction Factor (dB/m)
1	*5700.00	100.6 PK			1.37 H	156	98.3	2.3
2	*5700.00	89.3 AV			1.37 H	156	87.0	2.3
3	#5725.00	56.8 PK	68.2	-11.4	1.37 H	156	54.4	2.4
4	11400.00	46.5 PK	74.0	-27.5	1.66 H	227	34.0	12.5
5	11400.00	36.2 AV	54.0	-17.8	1.66 H	227	23.7	12.5
6	#17100.00	54.0 PK	68.2	-14.2	1.32 H	305	37.2	16.8

Antenna Polarity & Test Distance : Vertical at 3 m

No	Frequency (MHz)	Emission Level (dBuV/m)	Limit (dBuV/m)	Margin (dB)	Antenna Height (m)	Table Angle (Degree)	Raw Value (dBuV)	Correction Factor (dB/m)
1	*5700.00	114.2 PK			1.38 V	278	111.9	2.3
2	*5700.00	102.9 AV			1.38 V	278	100.6	2.3
3	#5725.00	66.4 PK	68.2	-1.8	1.38 V	278	64.0	2.4
4	11400.00	48.6 PK	74.0	-25.4	2.14 V	323	36.1	12.5
5	11400.00	37.8 AV	54.0	-16.2	2.14 V	323	25.3	12.5
6	#17100.00	55.9 PK	68.2	-12.3	1.94 V	245	39.1	16.8

Remarks:

1. Emission Level(dBuV/m) = Raw Value(dBuV) + Correction Factor(dB/m)
2. Correction Factor(dB/m) = Antenna Factor(dB/m) + Cable Factor(dB) – Pre-Amplifier Factor(dB)
3. Margin value = Emission Level – Limit value
4. The other emission levels were very low against the limit.
5. " * ": Fundamental frequency.
6. " # ": The radiated frequency is out of the restricted band.

RF Mode	TX 802.11ax (HE20)	Channel	CH 144 : 5720 MHz
Frequency Range	1GHz ~ 40GHz	Detector Function	Peak (PK) Average (AV)

Antenna Polarity & Test Distance : Horizontal at 3 m								
No	Frequency (MHz)	Emission Level (dBuV/m)	Limit (dBuV/m)	Margin (dB)	Antenna Height (m)	Table Angle (Degree)	Raw Value (dBuV)	Correction Factor (dB/m)
1	5460.00	49.8 PK	74.0	-24.2	1.15 H	97	47.7	2.1
2	5460.00	37.8 AV	54.0	-16.2	1.15 H	97	35.7	2.1
3	#5470.00	50.6 PK	68.2	-17.6	1.15 H	97	48.4	2.2
4	*5720.00	103.7 PK			1.15 H	97	101.3	2.4
5	*5720.00	92.0 AV			1.15 H	97	89.6	2.4
6	#5850.00	49.8 PK	68.2	-18.4	1.15 H	97	47.1	2.7
7	11440.00	46.3 PK	74.0	-27.7	1.68 H	234	33.9	12.4
8	11440.00	36.1 AV	54.0	-17.9	1.68 H	234	23.7	12.4
9	#17160.00	54.7 PK	68.2	-13.5	1.22 H	313	38.1	16.6

Antenna Polarity & Test Distance : Vertical at 3 m								
No	Frequency (MHz)	Emission Level (dBuV/m)	Limit (dBuV/m)	Margin (dB)	Antenna Height (m)	Table Angle (Degree)	Raw Value (dBuV)	Correction Factor (dB/m)
1	5460.00	50.5 PK	74.0	-23.5	1.43 V	277	48.4	2.1
2	5460.00	38.4 AV	54.0	-15.6	1.43 V	277	36.3	2.1
3	#5470.00	51.1 PK	68.2	-17.1	1.43 V	277	48.9	2.2
4	*5720.00	115.5 PK			1.43 V	277	113.1	2.4
5	*5720.00	104.3 AV			1.43 V	277	101.9	2.4
6	#5850.00	50.4 PK	68.2	-17.8	1.43 V	277	47.7	2.7
7	11440.00	47.8 PK	74.0	-26.2	2.22 V	350	35.4	12.4
8	11440.00	37.3 AV	54.0	-16.7	2.22 V	350	24.9	12.4
9	#17160.00	56.1 PK	68.2	-12.1	1.96 V	245	39.5	16.6

Remarks:

1. Emission Level(dBuV/m) = Raw Value(dBuV) + Correction Factor(dB/m)
2. Correction Factor(dB/m) = Antenna Factor(dB/m) + Cable Factor(dB) – Pre-Amplifier Factor(dB)
3. Margin value = Emission Level – Limit value
4. The other emission levels were very low against the limit.
5. " * ": Fundamental frequency.
6. " # ": The radiated frequency is out of the restricted band.

RF Mode	TX 802.11ax (HE20)	Channel	CH 149 : 5745 MHz
Frequency Range	1GHz ~ 40GHz	Detector Function	Peak (PK) Average (AV)

Antenna Polarity & Test Distance : Horizontal at 3 m								
No	Frequency (MHz)	Emission Level (dBuV/m)	Limit (dBuV/m)	Margin (dB)	Antenna Height (m)	Table Angle (Degree)	Raw Value (dBuV)	Correction Factor (dB/m)
1	#5638.90	50.8 PK	68.2	-17.4	2.56 H	145	48.5	2.3
2	*5745.00	103.2 PK			2.56 H	145	100.8	2.4
3	*5745.00	92.8 AV			2.56 H	145	90.4	2.4
4	#6015.90	51.6 PK	68.2	-16.6	2.56 H	145	48.7	2.9
5	11490.00	46.0 PK	74.0	-28.0	1.63 H	238	33.4	12.6
6	11490.00	35.5 AV	54.0	-18.5	1.63 H	238	22.9	12.6
7	#17235.00	54.6 PK	68.2	-13.6	1.33 H	313	37.8	16.8

Antenna Polarity & Test Distance : Vertical at 3 m								
No	Frequency (MHz)	Emission Level (dBuV/m)	Limit (dBuV/m)	Margin (dB)	Antenna Height (m)	Table Angle (Degree)	Raw Value (dBuV)	Correction Factor (dB/m)
1	#5575.72	50.9 PK	68.2	-17.3	1.44 V	278	48.8	2.1
2	*5745.00	117.1 PK			1.44 V	278	114.7	2.4
3	*5745.00	105.8 AV			1.44 V	278	103.4	2.4
4	#5999.64	51.9 PK	68.2	-16.3	1.44 V	278	49.0	2.9
5	11490.00	48.1 PK	74.0	-25.9	2.16 V	324	35.5	12.6
6	11490.00	37.4 AV	54.0	-16.6	2.16 V	324	24.8	12.6
7	#17235.00	56.5 PK	68.2	-11.7	1.93 V	256	39.7	16.8

Remarks:

1. Emission Level(dBuV/m) = Raw Value(dBuV) + Correction Factor(dB/m)
2. Correction Factor(dB/m) = Antenna Factor(dB/m) + Cable Factor(dB) – Pre-Amplifier Factor(dB)
3. Margin value = Emission Level – Limit value
4. The other emission levels were very low against the limit.
5. " * ": Fundamental frequency.
6. " # ": The radiated frequency is out of the restricted band.

RF Mode	TX 802.11ax (HE20)	Channel	CH 157 : 5785 MHz
Frequency Range	1GHz ~ 40GHz	Detector Function	Peak (PK) Average (AV)

Antenna Polarity & Test Distance : Horizontal at 3 m

No	Frequency (MHz)	Emission Level (dBuV/m)	Limit (dBuV/m)	Margin (dB)	Antenna Height (m)	Table Angle (Degree)	Raw Value (dBuV)	Correction Factor (dB/m)
1	#5638.33	50.5 PK	68.2	-17.7	2.63 H	142	48.2	2.3
2	*5785.00	103.0 PK			2.63 H	142	100.4	2.6
3	*5785.00	92.7 AV			2.63 H	142	90.1	2.6
4	#5996.39	50.4 PK	68.2	-17.8	2.63 H	142	47.5	2.9
5	11570.00	45.9 PK	74.0	-28.1	1.69 H	252	33.3	12.6
6	11570.00	35.4 AV	54.0	-18.6	1.69 H	252	22.8	12.6
7	#17355.00	55.0 PK	68.2	-13.2	1.34 H	310	37.3	17.7

Antenna Polarity & Test Distance : Vertical at 3 m

No	Frequency (MHz)	Emission Level (dBuV/m)	Limit (dBuV/m)	Margin (dB)	Antenna Height (m)	Table Angle (Degree)	Raw Value (dBuV)	Correction Factor (dB/m)
1	#5552.41	52.0 PK	68.2	-16.2	1.46 V	281	49.9	2.1
2	*5785.00	116.9 PK			1.46 V	281	114.3	2.6
3	*5785.00	105.7 AV			1.46 V	281	103.1	2.6
4	#5955.56	52.2 PK	68.2	-16.0	1.46 V	281	49.3	2.9
5	11570.00	48.8 PK	74.0	-25.2	2.12 V	342	36.2	12.6
6	11570.00	38.0 AV	54.0	-16.0	2.12 V	342	25.4	12.6
7	#17355.00	56.1 PK	68.2	-12.1	1.98 V	255	38.4	17.7

Remarks:

1. Emission Level(dBuV/m) = Raw Value(dBuV) + Correction Factor(dB/m)
2. Correction Factor(dB/m) = Antenna Factor(dB/m) + Cable Factor(dB) – Pre-Amplifier Factor(dB)
3. Margin value = Emission Level – Limit value
4. The other emission levels were very low against the limit.
5. " * ": Fundamental frequency.
6. " # ": The radiated frequency is out of the restricted band.

RF Mode	TX 802.11ax (HE20)	Channel	CH 165 : 5825 MHz
Frequency Range	1GHz ~ 40GHz	Detector Function	Peak (PK) Average (AV)

Antenna Polarity & Test Distance : Horizontal at 3 m

No	Frequency (MHz)	Emission Level (dBuV/m)	Limit (dBuV/m)	Margin (dB)	Antenna Height (m)	Table Angle (Degree)	Raw Value (dBuV)	Correction Factor (dB/m)
1	#5575.09	49.9 PK	68.2	-18.3	2.58 H	133	47.8	2.1
2	*5825.00	103.5 PK			2.58 H	133	100.9	2.6
3	*5825.00	92.9 AV			2.58 H	133	90.3	2.6
4	#5949.36	50.2 PK	68.2	-18.0	2.58 H	133	47.3	2.9
5	11650.00	45.8 PK	74.0	-28.2	1.59 H	248	33.6	12.2
6	11650.00	35.8 AV	54.0	-18.2	1.59 H	248	23.6	12.2
7	#17475.00	54.5 PK	68.2	-13.7	1.26 H	333	35.8	18.7

Antenna Polarity & Test Distance : Vertical at 3 m

No	Frequency (MHz)	Emission Level (dBuV/m)	Limit (dBuV/m)	Margin (dB)	Antenna Height (m)	Table Angle (Degree)	Raw Value (dBuV)	Correction Factor (dB/m)
1	#5595.48	51.4 PK	68.2	-16.8	1.55 V	273	49.3	2.1
2	*5825.00	117.0 PK			1.55 V	273	114.4	2.6
3	*5825.00	105.7 AV			1.55 V	273	103.1	2.6
4	#5945.59	52.7 PK	68.2	-15.5	1.55 V	273	49.8	2.9
5	11650.00	48.8 PK	74.0	-25.2	2.08 V	348	36.6	12.2
6	11650.00	37.9 AV	54.0	-16.1	2.08 V	348	25.7	12.2
7	#17475.00	55.9 PK	68.2	-12.3	2.02 V	244	37.2	18.7

Remarks:

1. Emission Level(dBuV/m) = Raw Value(dBuV) + Correction Factor(dB/m)
2. Correction Factor(dB/m) = Antenna Factor(dB/m) + Cable Factor(dB) – Pre-Amplifier Factor(dB)
3. Margin value = Emission Level – Limit value
4. The other emission levels were very low against the limit.
5. " * ": Fundamental frequency.
6. " # ": The radiated frequency is out of the restricted band.

RF Mode	TX 802.11ax (HE40)	Channel	CH 38 : 5190 MHz
Frequency Range	1GHz ~ 40GHz	Detector Function	Peak (PK) Average (AV)

Antenna Polarity & Test Distance : Horizontal at 3 m								
No	Frequency (MHz)	Emission Level (dBuV/m)	Limit (dBuV/m)	Margin (dB)	Antenna Height (m)	Table Angle (Degree)	Raw Value (dBuV)	Correction Factor (dB/m)
1	5150.00	58.2 PK	74.0	-15.8	1.07 H	107	55.9	2.3
2	5150.00	42.1 AV	54.0	-11.9	1.07 H	107	39.8	2.3
3	*5190.00	99.3 PK			1.07 H	107	97.2	2.1
4	*5190.00	87.6 AV			1.07 H	107	85.5	2.1
5	#10380.00	46.0 PK	68.2	-22.2	1.57 H	251	34.0	12.0
6	15570.00	54.5 PK	74.0	-19.5	1.23 H	319	42.8	11.7
7	15570.00	41.6 AV	54.0	-12.4	1.23 H	319	29.9	11.7

Antenna Polarity & Test Distance : Vertical at 3 m								
No	Frequency (MHz)	Emission Level (dBuV/m)	Limit (dBuV/m)	Margin (dB)	Antenna Height (m)	Table Angle (Degree)	Raw Value (dBuV)	Correction Factor (dB/m)
1	5150.00	70.0 PK	74.0	-4.0	1.42 V	287	67.7	2.3
2	5150.00	52.4 AV	54.0	-1.6	1.42 V	287	50.1	2.3
3	*5190.00	110.1 PK			1.42 V	287	108.0	2.1
4	*5190.00	98.2 AV			1.42 V	287	96.1	2.1
5	#10380.00	48.1 PK	68.2	-20.1	2.10 V	351	36.1	12.0
6	15570.00	56.1 PK	74.0	-17.9	2.05 V	231	44.4	11.7
7	15570.00	43.1 AV	54.0	-10.9	2.05 V	231	31.4	11.7

Remarks:

1. Emission Level(dBuV/m) = Raw Value(dBuV) + Correction Factor(dB/m)
2. Correction Factor(dB/m) = Antenna Factor(dB/m) + Cable Factor(dB) – Pre-Amplifier Factor(dB)
3. Margin value = Emission Level – Limit value
4. The other emission levels were very low against the limit.
5. " * ": Fundamental frequency.
6. " # ": The radiated frequency is out of the restricted band.

RF Mode	TX 802.11ax (HE40)	Channel	CH 46 : 5230 MHz
Frequency Range	1GHz ~ 40GHz	Detector Function	Peak (PK) Average (AV)

Antenna Polarity & Test Distance : Horizontal at 3 m								
No	Frequency (MHz)	Emission Level (dBuV/m)	Limit (dBuV/m)	Margin (dB)	Antenna Height (m)	Table Angle (Degree)	Raw Value (dBuV)	Correction Factor (dB/m)
1	5150.00	58.8 PK	74.0	-15.2	1.10 H	113	56.5	2.3
2	5150.00	41.8 AV	54.0	-12.2	1.10 H	113	39.5	2.3
3	*5230.00	101.6 PK			1.10 H	113	99.5	2.1
4	*5230.00	89.6 AV			1.10 H	113	87.5	2.1
5	#10460.00	46.7 PK	68.2	-21.5	1.60 H	226	34.7	12.0
6	15690.00	54.3 PK	74.0	-19.7	1.25 H	333	42.4	11.9
7	15690.00	41.4 AV	54.0	-12.6	1.25 H	333	29.5	11.9

Antenna Polarity & Test Distance : Vertical at 3 m								
No	Frequency (MHz)	Emission Level (dBuV/m)	Limit (dBuV/m)	Margin (dB)	Antenna Height (m)	Table Angle (Degree)	Raw Value (dBuV)	Correction Factor (dB/m)
1	5150.00	60.1 PK	74.0	-13.9	1.48 V	271	57.8	2.3
2	5150.00	42.9 AV	54.0	-11.1	1.48 V	271	40.6	2.3
3	*5230.00	112.3 PK			1.48 V	271	110.2	2.1
4	*5230.00	100.6 AV			1.48 V	271	98.5	2.1
5	#10460.00	48.8 PK	68.2	-19.4	2.12 V	344	36.8	12.0
6	15690.00	55.4 PK	74.0	-18.6	1.99 V	238	43.5	11.9
7	15690.00	42.5 AV	54.0	-11.5	1.99 V	238	30.6	11.9

Remarks:

1. Emission Level(dBuV/m) = Raw Value(dBuV) + Correction Factor(dB/m)
2. Correction Factor(dB/m) = Antenna Factor(dB/m) + Cable Factor(dB) – Pre-Amplifier Factor(dB)
3. Margin value = Emission Level – Limit value
4. The other emission levels were very low against the limit.
5. " * ": Fundamental frequency.
6. " # ": The radiated frequency is out of the restricted band.

RF Mode	TX 802.11ax (HE40)	Channel	CH 54 : 5270 MHz
Frequency Range	1GHz ~ 40GHz	Detector Function	Peak (PK) Average (AV)

Antenna Polarity & Test Distance : Horizontal at 3 m

No	Frequency (MHz)	Emission Level (dBuV/m)	Limit (dBuV/m)	Margin (dB)	Antenna Height (m)	Table Angle (Degree)	Raw Value (dBuV)	Correction Factor (dB/m)
1	*5270.00	101.3 PK			1.08 H	110	99.4	1.9
2	*5270.00	89.4 AV			1.08 H	110	87.5	1.9
3	5350.00	60.4 PK	74.0	-13.6	1.08 H	110	58.5	1.9
4	5350.00	42.9 AV	54.0	-11.1	1.08 H	110	41.0	1.9
5	#10540.00	46.4 PK	68.2	-21.8	1.63 H	222	34.5	11.9
6	15810.00	54.2 PK	74.0	-19.8	1.23 H	315	42.8	11.4
7	15810.00	41.5 AV	54.0	-12.5	1.23 H	315	30.1	11.4

Antenna Polarity & Test Distance : Vertical at 3 m

No	Frequency (MHz)	Emission Level (dBuV/m)	Limit (dBuV/m)	Margin (dB)	Antenna Height (m)	Table Angle (Degree)	Raw Value (dBuV)	Correction Factor (dB/m)
1	*5270.00	112.7 PK			1.45 V	275	110.8	1.9
2	*5270.00	100.6 AV			1.45 V	275	98.7	1.9
3	5350.00	63.6 PK	74.0	-10.4	1.45 V	275	61.7	1.9
4	5350.00	43.7 AV	54.0	-10.3	1.45 V	275	41.8	1.9
5	#10540.00	48.4 PK	68.2	-19.8	2.06 V	338	36.5	11.9
6	15810.00	55.6 PK	74.0	-18.4	2.02 V	241	44.2	11.4
7	15810.00	42.7 AV	54.0	-11.3	2.02 V	241	31.3	11.4

Remarks:

1. Emission Level(dBuV/m) = Raw Value(dBuV) + Correction Factor(dB/m)
2. Correction Factor(dB/m) = Antenna Factor(dB/m) + Cable Factor(dB) – Pre-Amplifier Factor(dB)
3. Margin value = Emission Level – Limit value
4. The other emission levels were very low against the limit.
5. " * ": Fundamental frequency.
6. " # ": The radiated frequency is out of the restricted band.

RF Mode	TX 802.11ax (HE40)	Channel	CH 62 : 5310 MHz
Frequency Range	1GHz ~ 40GHz	Detector Function	Peak (PK) Average (AV)

Antenna Polarity & Test Distance : Horizontal at 3 m

No	Frequency (MHz)	Emission Level (dBuV/m)	Limit (dBuV/m)	Margin (dB)	Antenna Height (m)	Table Angle (Degree)	Raw Value (dBuV)	Correction Factor (dB/m)
1	*5310.00	96.8 PK			1.61 H	167	95.0	1.8
2	*5310.00	85.4 AV			1.61 H	167	83.6	1.8
3	5350.00	57.7 PK	74.0	-16.3	1.61 H	167	55.8	1.9
4	5350.00	41.4 AV	54.0	-12.6	1.61 H	167	39.5	1.9
5	10620.00	46.3 PK	74.0	-27.7	1.68 H	250	34.5	11.8
6	10620.00	36.2 AV	54.0	-17.8	1.68 H	250	24.4	11.8
7	15930.00	54.6 PK	74.0	-19.4	1.30 H	328	43.1	11.5
8	15930.00	41.6 AV	54.0	-12.4	1.30 H	328	30.1	11.5

Antenna Polarity & Test Distance : Vertical at 3 m

No	Frequency (MHz)	Emission Level (dBuV/m)	Limit (dBuV/m)	Margin (dB)	Antenna Height (m)	Table Angle (Degree)	Raw Value (dBuV)	Correction Factor (dB/m)
1	*5310.00	109.9 PK			1.62 V	274	108.1	1.8
2	*5310.00	98.2 AV			1.62 V	274	96.4	1.8
3	5350.00	69.3 PK	74.0	-4.7	1.62 V	274	67.4	1.9
4	5350.00	52.3 AV	54.0	-1.7	1.62 V	274	50.4	1.9
5	10620.00	48.8 PK	74.0	-25.2	2.03 V	333	37.0	11.8
6	10620.00	37.8 AV	54.0	-16.2	2.03 V	333	26.0	11.8
7	15930.00	56.7 PK	74.0	-17.3	2.04 V	235	45.2	11.5
8	15930.00	43.3 AV	54.0	-10.7	2.04 V	235	31.8	11.5

Remarks:

1. Emission Level(dBuV/m) = Raw Value(dBuV) + Correction Factor(dB/m)
2. Correction Factor(dB/m) = Antenna Factor(dB/m) + Cable Factor(dB) – Pre-Amplifier Factor(dB)
3. Margin value = Emission Level – Limit value
4. The other emission levels were very low against the limit.
5. " * ": Fundamental frequency.

RF Mode	TX 802.11ax (HE40)	Channel	CH 102 : 5510 MHz
Frequency Range	1GHz ~ 40GHz	Detector Function	Peak (PK) Average (AV)

Antenna Polarity & Test Distance : Horizontal at 3 m

No	Frequency (MHz)	Emission Level (dBuV/m)	Limit (dBuV/m)	Margin (dB)	Antenna Height (m)	Table Angle (Degree)	Raw Value (dBuV)	Correction Factor (dB/m)
1	5453.70	50.6 PK	74.0	-23.4	1.35 H	168	48.5	2.1
2	5453.70	38.2 AV	54.0	-15.8	1.35 H	168	36.1	2.1
3	#5465.75	51.6 PK	68.2	-16.6	1.35 H	168	49.5	2.1
4	*5510.00	95.5 PK			1.35 H	168	93.4	2.1
5	*5510.00	83.8 AV			1.35 H	168	81.7	2.1
6	11020.00	46.5 PK	74.0	-27.5	1.58 H	228	34.2	12.3
7	11020.00	36.0 AV	54.0	-18.0	1.58 H	228	23.7	12.3
8	#16530.00	54.9 PK	68.2	-13.3	1.29 H	319	41.0	13.9

Antenna Polarity & Test Distance : Vertical at 3 m

No	Frequency (MHz)	Emission Level (dBuV/m)	Limit (dBuV/m)	Margin (dB)	Antenna Height (m)	Table Angle (Degree)	Raw Value (dBuV)	Correction Factor (dB/m)
1	5460.00	60.0 PK	74.0	-14.0	1.59 V	271	57.9	2.1
2	5460.00	45.2 AV	54.0	-8.8	1.59 V	271	43.1	2.1
3	#5467.68	66.4 PK	68.2	-1.8	1.59 V	271	64.2	2.2
4	*5510.00	108.5 PK			1.59 V	271	106.4	2.1
5	*5510.00	97.0 AV			1.59 V	271	94.9	2.1
6	11020.00	48.7 PK	74.0	-25.3	2.10 V	340	36.4	12.3
7	11020.00	38.1 AV	54.0	-15.9	2.10 V	340	25.8	12.3
8	#16530.00	55.4 PK	68.2	-12.8	2.04 V	252	41.5	13.9

Remarks:

1. Emission Level(dBuV/m) = Raw Value(dBuV) + Correction Factor(dB/m)
2. Correction Factor(dB/m) = Antenna Factor(dB/m) + Cable Factor(dB) – Pre-Amplifier Factor(dB)
3. Margin value = Emission Level – Limit value
4. The other emission levels were very low against the limit.
5. " * ": Fundamental frequency.
6. " # ": The radiated frequency is out of the restricted band.

RF Mode	TX 802.11ax (HE40)	Channel	CH 110 : 5550 MHz
Frequency Range	1GHz ~ 40GHz	Detector Function	Peak (PK) Average (AV)

Antenna Polarity & Test Distance : Horizontal at 3 m								
No	Frequency (MHz)	Emission Level (dBuV/m)	Limit (dBuV/m)	Margin (dB)	Antenna Height (m)	Table Angle (Degree)	Raw Value (dBuV)	Correction Factor (dB/m)
1	5460.00	57.8 PK	74.0	-16.2	1.40 H	163	55.7	2.1
2	5460.00	41.1 AV	54.0	-12.9	1.40 H	163	39.0	2.1
3	#5470.00	60.8 PK	68.2	-7.4	1.40 H	163	58.6	2.2
4	*5550.00	101.6 PK			1.40 H	163	99.5	2.1
5	*5550.00	89.5 AV			1.40 H	163	87.4	2.1
6	11100.00	45.7 PK	74.0	-28.3	1.61 H	243	33.8	11.9
7	11100.00	35.3 AV	54.0	-18.7	1.61 H	243	23.4	11.9
8	#16650.00	54.5 PK	68.2	-13.7	1.24 H	308	39.7	14.8
Antenna Polarity & Test Distance : Vertical at 3 m								
No	Frequency (MHz)	Emission Level (dBuV/m)	Limit (dBuV/m)	Margin (dB)	Antenna Height (m)	Table Angle (Degree)	Raw Value (dBuV)	Correction Factor (dB/m)
1	5460.00	59.4 PK	74.0	-14.6	1.38 V	277	57.3	2.1
2	5460.00	42.7 AV	54.0	-11.3	1.38 V	277	40.6	2.1
3	#5470.00	63.1 PK	68.2	-5.1	1.38 V	277	60.9	2.2
4	*5550.00	111.3 PK			1.38 V	277	109.2	2.1
5	*5550.00	100.6 AV			1.38 V	277	98.5	2.1
6	11100.00	48.6 PK	74.0	-25.4	2.10 V	343	36.7	11.9
7	11100.00	37.6 AV	54.0	-16.4	2.10 V	343	25.7	11.9
8	#16650.00	55.7 PK	68.2	-12.5	2.04 V	246	40.9	14.8

Remarks:

1. Emission Level(dBuV/m) = Raw Value(dBuV) + Correction Factor(dB/m)
2. Correction Factor(dB/m) = Antenna Factor(dB/m) + Cable Factor(dB) – Pre-Amplifier Factor(dB)
3. Margin value = Emission Level – Limit value
4. The other emission levels were very low against the limit.
5. " * ": Fundamental frequency.
6. " # ": The radiated frequency is out of the restricted band.

RF Mode	TX 802.11ax (HE40)	Channel	CH 134 : 5670 MHz
Frequency Range	1GHz ~ 40GHz	Detector Function	Peak (PK) Average (AV)

Antenna Polarity & Test Distance : Horizontal at 3 m

No	Frequency (MHz)	Emission Level (dBuV/m)	Limit (dBuV/m)	Margin (dB)	Antenna Height (m)	Table Angle (Degree)	Raw Value (dBuV)	Correction Factor (dB/m)
1	*5670.00	100.2 PK			1.43 H	171	97.9	2.3
2	*5670.00	88.6 AV			1.43 H	171	86.3	2.3
3	#5725.00	59.6 PK	68.2	-8.6	1.43 H	171	57.2	2.4
4	11340.00	46.5 PK	74.0	-27.5	1.69 H	223	34.3	12.2
5	11340.00	36.0 AV	54.0	-18.0	1.69 H	223	23.8	12.2
6	#17010.00	54.9 PK	68.2	-13.3	1.25 H	325	38.3	16.6

Antenna Polarity & Test Distance : Vertical at 3 m

No	Frequency (MHz)	Emission Level (dBuV/m)	Limit (dBuV/m)	Margin (dB)	Antenna Height (m)	Table Angle (Degree)	Raw Value (dBuV)	Correction Factor (dB/m)
1	*5670.00	112.2 PK			1.58 V	278	109.9	2.3
2	*5670.00	100.2 AV			1.58 V	278	97.9	2.3
3	#5732.68	66.4 PK	68.2	-1.8	1.58 V	278	63.9	2.5
4	11340.00	49.4 PK	74.0	-24.6	2.06 V	339	37.2	12.2
5	11340.00	38.3 AV	54.0	-15.7	2.06 V	339	26.1	12.2
6	#17010.00	55.7 PK	68.2	-12.5	2.00 V	230	39.1	16.6

Remarks:

1. Emission Level(dBuV/m) = Raw Value(dBuV) + Correction Factor(dB/m)
2. Correction Factor(dB/m) = Antenna Factor(dB/m) + Cable Factor(dB) – Pre-Amplifier Factor(dB)
3. Margin value = Emission Level – Limit value
4. The other emission levels were very low against the limit.
5. " * " : Fundamental frequency.
6. " # " : The radiated frequency is out of the restricted band.

RF Mode	TX 802.11ax (HE40)	Channel	CH 142 : 5710 MHz
Frequency Range	1GHz ~ 40GHz	Detector Function	Peak (PK) Average (AV)

Antenna Polarity & Test Distance : Horizontal at 3 m

No	Frequency (MHz)	Emission Level (dBuV/m)	Limit (dBuV/m)	Margin (dB)	Antenna Height (m)	Table Angle (Degree)	Raw Value (dBuV)	Correction Factor (dB/m)
1	5460.00	51.1 PK	74.0	-22.9	1.41 H	168	49.0	2.1
2	5460.00	37.9 AV	54.0	-16.1	1.41 H	168	35.8	2.1
3	#5470.00	52.1 PK	68.2	-16.1	1.41 H	168	49.9	2.2
4	*5710.00	100.8 PK			1.41 H	168	98.4	2.4
5	*5710.00	89.0 AV			1.41 H	168	86.6	2.4
6	#5850.00	53.8 PK	68.2	-14.4	1.41 H	168	51.1	2.7
7	11420.00	46.4 PK	74.0	-27.6	1.65 H	230	33.9	12.5
8	11420.00	36.1 AV	54.0	-17.9	1.65 H	230	23.6	12.5
9	#17130.00	54.5 PK	68.2	-13.7	1.32 H	328	37.7	16.8

Antenna Polarity & Test Distance : Vertical at 3 m

No	Frequency (MHz)	Emission Level (dBuV/m)	Limit (dBuV/m)	Margin (dB)	Antenna Height (m)	Table Angle (Degree)	Raw Value (dBuV)	Correction Factor (dB/m)
1	5460.00	51.8 PK	74.0	-22.2	1.58 V	271	49.7	2.1
2	5460.00	38.1 AV	54.0	-15.9	1.58 V	271	36.0	2.1
3	#5470.00	53.1 PK	68.2	-15.1	1.58 V	271	50.9	2.2
4	*5710.00	112.5 PK			1.58 V	271	110.1	2.4
5	*5710.00	100.8 AV			1.58 V	271	98.4	2.4
6	#5850.00	55.5 PK	68.2	-12.7	1.58 V	271	52.8	2.7
7	11420.00	48.7 PK	74.0	-25.3	2.14 V	336	36.2	12.5
8	11420.00	37.5 AV	54.0	-16.5	2.14 V	336	25.0	12.5
9	#17130.00	55.6 PK	68.2	-12.6	2.03 V	251	38.8	16.8

Remarks:

1. Emission Level(dBuV/m) = Raw Value(dBuV) + Correction Factor(dB/m)
2. Correction Factor(dB/m) = Antenna Factor(dB/m) + Cable Factor(dB) – Pre-Amplifier Factor(dB)
3. Margin value = Emission Level – Limit value
4. The other emission levels were very low against the limit.
5. " * ": Fundamental frequency.
6. " # ": The radiated frequency is out of the restricted band.

RF Mode	TX 802.11ax (HE40)	Channel	CH 151 : 5755 MHz
Frequency Range	1GHz ~ 40GHz	Detector Function	Peak (PK) Average (AV)

Antenna Polarity & Test Distance : Horizontal at 3 m

No	Frequency (MHz)	Emission Level (dBuV/m)	Limit (dBuV/m)	Margin (dB)	Antenna Height (m)	Table Angle (Degree)	Raw Value (dBuV)	Correction Factor (dB/m)
1	#5632.16	49.8 PK	68.2	-18.4	2.61 H	139	47.5	2.3
2	*5755.00	100.4 PK			2.61 H	139	97.9	2.5
3	*5755.00	88.2 AV			2.61 H	139	85.7	2.5
4	#5971.19	51.3 PK	68.2	-16.9	2.61 H	139	48.4	2.9
5	11510.00	45.4 PK	74.0	-28.6	1.66 H	250	32.8	12.6
6	11510.00	35.4 AV	54.0	-18.6	1.66 H	250	22.8	12.6
7	#17265.00	54.6 PK	68.2	-13.6	1.34 H	318	37.7	16.9

Antenna Polarity & Test Distance : Vertical at 3 m

No	Frequency (MHz)	Emission Level (dBuV/m)	Limit (dBuV/m)	Margin (dB)	Antenna Height (m)	Table Angle (Degree)	Raw Value (dBuV)	Correction Factor (dB/m)
1	#5649.67	53.9 PK	68.2	-14.3	1.48 V	288	51.6	2.3
2	*5755.00	112.8 PK			1.48 V	288	110.3	2.5
3	*5755.00	101.7 AV			1.48 V	288	99.2	2.5
4	#5930.75	52.6 PK	68.2	-15.6	1.48 V	288	49.7	2.9
5	11510.00	48.6 PK	74.0	-25.4	2.10 V	344	36.0	12.6
6	11510.00	37.7 AV	54.0	-16.3	2.10 V	344	25.1	12.6
7	#17265.00	56.3 PK	68.2	-11.9	1.97 V	255	39.4	16.9

Remarks:

1. Emission Level(dBuV/m) = Raw Value(dBuV) + Correction Factor(dB/m)
2. Correction Factor(dB/m) = Antenna Factor(dB/m) + Cable Factor(dB) – Pre-Amplifier Factor(dB)
3. Margin value = Emission Level – Limit value
4. The other emission levels were very low against the limit.
5. " * ": Fundamental frequency.
6. " # ": The radiated frequency is out of the restricted band.

RF Mode	TX 802.11ax (HE40)	Channel	CH 159 : 5795 MHz
Frequency Range	1GHz ~ 40GHz	Detector Function	Peak (PK) Average (AV)

Antenna Polarity & Test Distance : Horizontal at 3 m								
No	Frequency (MHz)	Emission Level (dBuV/m)	Limit (dBuV/m)	Margin (dB)	Antenna Height (m)	Table Angle (Degree)	Raw Value (dBuV)	Correction Factor (dB/m)
1	#5629.61	50.4 PK	68.2	-17.8	2.57 H	135	48.1	2.3
2	*5795.00	100.2 PK			2.57 H	135	97.6	2.6
3	*5795.00	87.9 AV			2.57 H	135	85.3	2.6
4	#6022.65	51.3 PK	68.2	-16.9	2.57 H	135	48.3	3.0
5	11590.00	46.1 PK	74.0	-27.9	1.64 H	242	33.5	12.6
6	11590.00	35.7 AV	54.0	-18.3	1.64 H	242	23.1	12.6
7	#17385.00	54.9 PK	68.2	-13.3	1.23 H	309	37.0	17.9

Antenna Polarity & Test Distance : Vertical at 3 m								
No	Frequency (MHz)	Emission Level (dBuV/m)	Limit (dBuV/m)	Margin (dB)	Antenna Height (m)	Table Angle (Degree)	Raw Value (dBuV)	Correction Factor (dB/m)
1	#5648.31	52.8 PK	68.2	-15.4	1.47 V	284	50.5	2.3
2	*5795.00	113.0 PK			1.47 V	284	110.4	2.6
3	*5795.00	101.6 AV			1.47 V	284	99.0	2.6
4	#5931.76	57.4 PK	68.2	-10.8	1.47 V	284	54.5	2.9
5	11590.00	49.0 PK	74.0	-25.0	2.12 V	356	36.4	12.6
6	11590.00	38.3 AV	54.0	-15.7	2.12 V	356	25.7	12.6
7	#17385.00	55.7 PK	68.2	-12.5	1.99 V	231	37.8	17.9

Remarks:

1. Emission Level(dBuV/m) = Raw Value(dBuV) + Correction Factor(dB/m)
2. Correction Factor(dB/m) = Antenna Factor(dB/m) + Cable Factor(dB) – Pre-Amplifier Factor(dB)
3. Margin value = Emission Level – Limit value
4. The other emission levels were very low against the limit.
5. " * ": Fundamental frequency.
6. " # ": The radiated frequency is out of the restricted band.

RF Mode	TX 802.11ax (HE80)	Channel	CH 42 : 5210 MHz
Frequency Range	1GHz ~ 40GHz	Detector Function	Peak (PK) Average (AV)

Antenna Polarity & Test Distance : Horizontal at 3 m								
No	Frequency (MHz)	Emission Level (dBuV/m)	Limit (dBuV/m)	Margin (dB)	Antenna Height (m)	Table Angle (Degree)	Raw Value (dBuV)	Correction Factor (dB/m)
1	5125.34	54.1 PK	74.0	-19.9	1.50 H	108	51.8	2.3
2	5125.34	41.4 AV	54.0	-12.6	1.50 H	108	39.1	2.3
3	*5210.00	92.9 PK			1.50 H	108	90.8	2.1
4	*5210.00	81.4 AV			1.50 H	108	79.3	2.1
5	5350.00	49.9 PK	74.0	-24.1	1.50 H	108	48.0	1.9
6	5350.00	37.3 AV	54.0	-16.7	1.50 H	108	35.4	1.9
7	#10420.00	46.1 PK	68.2	-22.1	1.58 H	239	34.0	12.1
8	15630.00	54.8 PK	74.0	-19.2	1.30 H	307	43.1	11.7
9	15630.00	42.0 AV	54.0	-12.0	1.30 H	307	30.3	11.7

Antenna Polarity & Test Distance : Vertical at 3 m								
No	Frequency (MHz)	Emission Level (dBuV/m)	Limit (dBuV/m)	Margin (dB)	Antenna Height (m)	Table Angle (Degree)	Raw Value (dBuV)	Correction Factor (dB/m)
1	5141.35	63.9 PK	74.0	-10.1	1.55 V	273	61.6	2.3
2	5141.35	52.4 AV	54.0	-1.6	1.55 V	273	50.1	2.3
3	5147.00	68.1 PK	74.0	-5.9	1.55 V	273	65.8	2.3
4	5147.00	51.7 AV	54.0	-2.3	1.55 V	273	49.4	2.3
5	*5210.00	105.5 PK			1.55 V	273	103.4	2.1
6	*5210.00	93.8 AV			1.55 V	273	91.7	2.1
7	5350.00	50.9 PK	74.0	-23.1	1.55 V	273	49.0	1.9
8	5350.00	39.4 AV	54.0	-14.6	1.55 V	273	37.5	1.9
9	#10420.00	49.4 PK	68.2	-18.8	2.15 V	356	37.3	12.1
10	15630.00	55.0 PK	74.0	-19.0	1.98 V	220	43.3	11.7
11	15630.00	42.4 AV	54.0	-11.6	1.98 V	220	30.7	11.7

Remarks:

1. Emission Level(dBuV/m) = Raw Value(dBuV) + Correction Factor(dB/m)
2. Correction Factor(dB/m) = Antenna Factor(dB/m) + Cable Factor(dB) – Pre-Amplifier Factor(dB)
3. Margin value = Emission Level – Limit value
4. The other emission levels were very low against the limit.
5. " * ": Fundamental frequency.
6. " # ": The radiated frequency is out of the restricted band.

RF Mode	TX 802.11ax (HE80)	Channel	CH 58 : 5290 MHz
Frequency Range	1GHz ~ 40GHz	Detector Function	Peak (PK) Average (AV)

Antenna Polarity & Test Distance : Horizontal at 3 m

No	Frequency (MHz)	Emission Level (dBuV/m)	Limit (dBuV/m)	Margin (dB)	Antenna Height (m)	Table Angle (Degree)	Raw Value (dBuV)	Correction Factor (dB/m)
1	5150.00	51.4 PK	74.0	-22.6	1.35 H	168	49.1	2.3
2	5150.00	38.5 AV	54.0	-15.5	1.35 H	168	36.2	2.3
3	*5290.00	91.7 PK			1.35 H	168	89.9	1.8
4	*5290.00	80.2 AV			1.35 H	168	78.4	1.8
5	5373.70	57.9 PK	74.0	-16.1	1.35 H	168	55.9	2.0
6	5373.70	42.1 AV	54.0	-11.9	1.35 H	168	40.1	2.0
7	#10580.00	46.2 PK	68.2	-22.0	1.59 H	251	34.4	11.8
8	15870.00	54.4 PK	74.0	-19.6	1.30 H	323	43.1	11.3
9	15870.00	41.6 AV	54.0	-12.4	1.30 H	323	30.3	11.3

Antenna Polarity & Test Distance : Vertical at 3 m

No	Frequency (MHz)	Emission Level (dBuV/m)	Limit (dBuV/m)	Margin (dB)	Antenna Height (m)	Table Angle (Degree)	Raw Value (dBuV)	Correction Factor (dB/m)
1	5150.00	53.2 PK	74.0	-20.8	1.27 V	273	50.9	2.3
2	5150.00	40.7 AV	54.0	-13.3	1.27 V	273	38.4	2.3
3	*5290.00	105.3 PK			1.27 V	273	103.5	1.8
4	*5290.00	93.9 AV			1.27 V	273	92.1	1.8
5	5358.00	68.1 PK	74.0	-5.9	1.27 V	273	66.1	2.0
6	5358.00	52.2 AV	54.0	-1.8	1.27 V	273	50.2	2.0
7	#10580.00	48.9 PK	68.2	-19.3	2.09 V	359	37.1	11.8
8	15870.00	55.4 PK	74.0	-18.6	1.96 V	220	44.1	11.3
9	15870.00	42.8 AV	54.0	-11.2	1.96 V	220	31.5	11.3

Remarks:

1. Emission Level(dBuV/m) = Raw Value(dBuV) + Correction Factor(dB/m)
2. Correction Factor(dB/m) = Antenna Factor(dB/m) + Cable Factor(dB) – Pre-Amplifier Factor(dB)
3. Margin value = Emission Level – Limit value
4. The other emission levels were very low against the limit.
5. " * ": Fundamental frequency.
6. " # ": The radiated frequency is out of the restricted band.

RF Mode	TX 802.11ax (HE80)	Channel	CH 106 : 5530 MHz
Frequency Range	1GHz ~ 40GHz	Detector Function	Peak (PK) Average (AV)

Antenna Polarity & Test Distance : Horizontal at 3 m

No	Frequency (MHz)	Emission Level (dBuV/m)	Limit (dBuV/m)	Margin (dB)	Antenna Height (m)	Table Angle (Degree)	Raw Value (dBuV)	Correction Factor (dB/m)
1	5442.50	49.7 PK	74.0	-24.3	1.43 H	163	47.6	2.1
2	5442.50	38.2 AV	54.0	-15.8	1.43 H	163	36.1	2.1
3	#5465.60	50.4 PK	68.2	-17.8	1.43 H	163	48.3	2.1
4	*5530.00	89.4 PK			1.43 H	163	87.4	2.0
5	*5530.00	78.8 AV			1.43 H	163	76.8	2.0
6	#5794.60	50.0 PK	68.2	-18.2	1.43 H	163	47.4	2.6
7	11060.00	45.9 PK	74.0	-28.1	1.58 H	241	33.8	12.1
8	11060.00	35.6 AV	54.0	-18.4	1.58 H	241	23.5	12.1
9	#16590.00	54.3 PK	68.2	-13.9	1.34 H	310	40.0	14.3

Antenna Polarity & Test Distance : Vertical at 3 m

No	Frequency (MHz)	Emission Level (dBuV/m)	Limit (dBuV/m)	Margin (dB)	Antenna Height (m)	Table Angle (Degree)	Raw Value (dBuV)	Correction Factor (dB/m)
1	5458.50	64.3 PK	74.0	-9.7	1.50 V	281	62.2	2.1
2	5458.50	47.8 AV	54.0	-6.2	1.50 V	281	45.7	2.1
3	#5467.11	66.6 PK	68.2	-1.6	1.50 V	281	64.4	2.2
4	*5530.00	104.0 PK			1.50 V	281	102.0	2.0
5	*5530.00	92.2 AV			1.50 V	281	90.2	2.0
6	#5770.48	51.6 PK	68.2	-16.6	1.50 V	281	49.1	2.5
7	11060.00	49.7 PK	74.0	-24.3	2.12 V	355	37.6	12.1
8	11060.00	38.8 AV	54.0	-15.2	2.12 V	355	26.7	12.1
9	#16590.00	55.9 PK	68.2	-12.3	2.02 V	217	41.6	14.3

Remarks:

1. Emission Level(dBuV/m) = Raw Value(dBuV) + Correction Factor(dB/m)
2. Correction Factor(dB/m) = Antenna Factor(dB/m) + Cable Factor(dB) – Pre-Amplifier Factor(dB)
3. Margin value = Emission Level – Limit value
4. The other emission levels were very low against the limit.
5. " * ": Fundamental frequency.
6. " # ": The radiated frequency is out of the restricted band.

RF Mode	TX 802.11ax (HE80)	Channel	CH 122 : 5610 MHz
Frequency Range	1GHz ~ 40GHz	Detector Function	Peak (PK) Average (AV)

Antenna Polarity & Test Distance : Horizontal at 3 m

No	Frequency (MHz)	Emission Level (dBuV/m)	Limit (dBuV/m)	Margin (dB)	Antenna Height (m)	Table Angle (Degree)	Raw Value (dBuV)	Correction Factor (dB/m)
1	*5610.00	92.9 PK			1.43 H	150	90.8	2.1
2	*5610.00	91.8 AV			1.43 H	150	89.7	2.1
3	#5725.00	53.8 PK	68.2	-14.4	1.43 H	150	51.4	2.4
4	11220.00	45.8 PK	74.0	-28.2	1.67 H	242	33.7	12.1
5	11220.00	35.4 AV	54.0	-18.6	1.67 H	242	23.3	12.1
6	#16830.00	55.2 PK	68.2	-13.0	1.25 H	306	39.4	15.8

Antenna Polarity & Test Distance : Vertical at 3 m

No	Frequency (MHz)	Emission Level (dBuV/m)	Limit (dBuV/m)	Margin (dB)	Antenna Height (m)	Table Angle (Degree)	Raw Value (dBuV)	Correction Factor (dB/m)
1	*5610.00	108.3 PK			1.52 V	282	106.2	2.1
2	*5610.00	96.7 AV			1.52 V	282	94.6	2.1
3	#5725.00	64.6 PK	68.2	-3.6	1.52 V	282	62.2	2.4
4	11220.00	48.5 PK	74.0	-25.5	2.09 V	345	36.4	12.1
5	11220.00	37.9 AV	54.0	-16.1	2.09 V	345	25.8	12.1
6	#16830.00	56.3 PK	68.2	-11.9	1.96 V	219	40.5	15.8

Remarks:

1. Emission Level(dBuV/m) = Raw Value(dBuV) + Correction Factor(dB/m)
2. Correction Factor(dB/m) = Antenna Factor(dB/m) + Cable Factor(dB) – Pre-Amplifier Factor(dB)
3. Margin value = Emission Level – Limit value
4. The other emission levels were very low against the limit.
5. " * " : Fundamental frequency.
6. " # " : The radiated frequency is out of the restricted band.

RF Mode	TX 802.11ax (HE80)	Channel	CH 138 : 5690 MHz
Frequency Range	1GHz ~ 40GHz	Detector Function	Peak (PK) Average (AV)

Antenna Polarity & Test Distance : Horizontal at 3 m

No	Frequency (MHz)	Emission Level (dBuV/m)	Limit (dBuV/m)	Margin (dB)	Antenna Height (m)	Table Angle (Degree)	Raw Value (dBuV)	Correction Factor (dB/m)
1	5460.00	53.6 PK	74.0	-20.4	1.45 H	148	51.5	2.1
2	5460.00	38.4 AV	54.0	-15.6	1.45 H	148	36.3	2.1
3	#5470.00	53.8 PK	68.2	-14.4	1.45 H	148	51.6	2.2
4	*5690.00	92.7 PK			1.45 H	148	90.4	2.3
5	*5690.00	91.5 AV			1.45 H	148	89.2	2.3
6	#5850.00	55.5 PK	68.2	-12.7	1.45 H	148	52.8	2.7
7	11380.00	46.1 PK	74.0	-27.9	1.60 H	222	33.7	12.4
8	11380.00	35.9 AV	54.0	-18.1	1.60 H	222	23.5	12.4
9	#17070.00	54.8 PK	68.2	-13.4	1.28 H	302	38.0	16.8

Antenna Polarity & Test Distance : Vertical at 3 m

No	Frequency (MHz)	Emission Level (dBuV/m)	Limit (dBuV/m)	Margin (dB)	Antenna Height (m)	Table Angle (Degree)	Raw Value (dBuV)	Correction Factor (dB/m)
1	5460.00	54.2 PK	74.0	-19.8	1.55 V	289	52.1	2.1
2	5460.00	39.9 AV	54.0	-14.1	1.55 V	289	37.8	2.1
3	#5470.00	55.6 PK	68.2	-12.6	1.55 V	289	53.4	2.2
4	*5690.00	108.1 PK			1.55 V	289	105.8	2.3
5	*5690.00	96.3 AV			1.55 V	289	94.0	2.3
6	#5850.00	62.7 PK	68.2	-5.5	1.55 V	289	60.0	2.7
7	11380.00	49.3 PK	74.0	-24.7	2.07 V	346	36.9	12.4
8	11380.00	38.5 AV	54.0	-15.5	2.07 V	346	26.1	12.4
9	#17070.00	55.4 PK	68.2	-12.8	2.00 V	220	38.6	16.8

Remarks:

1. Emission Level(dBuV/m) = Raw Value(dBuV) + Correction Factor(dB/m)
2. Correction Factor(dB/m) = Antenna Factor(dB/m) + Cable Factor(dB) – Pre-Amplifier Factor(dB)
3. Margin value = Emission Level – Limit value
4. The other emission levels were very low against the limit.
5. " * ": Fundamental frequency.
6. " # ": The radiated frequency is out of the restricted band.

RF Mode	TX 802.11ax (HE80)	Channel	CH 155 : 5775 MHz
Frequency Range	1GHz ~ 40GHz	Detector Function	Peak (PK) Average (AV)

Antenna Polarity & Test Distance : Horizontal at 3 m

No	Frequency (MHz)	Emission Level (dBuV/m)	Limit (dBuV/m)	Margin (dB)	Antenna Height (m)	Table Angle (Degree)	Raw Value (dBuV)	Correction Factor (dB/m)
1	#5649.09	52.1 PK	68.2	-16.1	1.26 H	139	49.8	2.3
2	*5775.00	95.6 PK			1.26 H	139	93.1	2.5
3	*5775.00	84.3 AV			1.26 H	139	81.8	2.5
4	#5929.45	54.7 PK	68.2	-13.5	1.26 H	139	51.8	2.9
5	11550.00	46.0 PK	74.0	-28.0	1.68 H	229	33.5	12.5
6	11550.00	35.7 AV	54.0	-18.3	1.68 H	229	23.2	12.5
7	#17325.00	55.0 PK	68.2	-13.2	1.32 H	321	37.7	17.3

Antenna Polarity & Test Distance : Vertical at 3 m

No	Frequency (MHz)	Emission Level (dBuV/m)	Limit (dBuV/m)	Margin (dB)	Antenna Height (m)	Table Angle (Degree)	Raw Value (dBuV)	Correction Factor (dB/m)
1	#5647.53	59.5 PK	68.2	-8.7	1.32 V	273	57.2	2.3
2	*5775.00	107.5 PK			1.32 V	273	105.0	2.5
3	*5775.00	96.1 AV			1.32 V	273	93.6	2.5
4	#5929.15	62.0 PK	68.2	-6.2	1.32 V	273	59.1	2.9
5	11550.00	48.5 PK	74.0	-25.5	2.08 V	356	36.0	12.5
6	11550.00	38.1 AV	54.0	-15.9	2.08 V	356	25.6	12.5
7	#17325.00	55.5 PK	68.2	-12.7	2.00 V	218	38.2	17.3

Remarks:

1. Emission Level(dBuV/m) = Raw Value(dBuV) + Correction Factor(dB/m)
2. Correction Factor(dB/m) = Antenna Factor(dB/m) + Cable Factor(dB) – Pre-Amplifier Factor(dB)
3. Margin value = Emission Level – Limit value
4. The other emission levels were very low against the limit.
5. " * ": Fundamental frequency.
6. " # ": The radiated frequency is out of the restricted band.

RF Mode	TX 20MHz Preamble 802.11ax (RU26)	Channel	CH 36 : 5180 MHz
Frequency Range	1GHz ~ 40GHz	Detector Function	Peak (PK) Average (AV)

Antenna Polarity & Test Distance : Horizontal at 3 m

No	Frequency (MHz)	Emission Level (dBuV/m)	Limit (dBuV/m)	Margin (dB)	Antenna Height (m)	Table Angle (Degree)	Raw Value (dBuV)	Correction Factor (dB/m)
1	5004.86	51.0 PK	74.0	-23.0	1.61 H	171	48.9	2.1
2	5004.86	37.4 AV	54.0	-16.6	1.61 H	171	35.3	2.1
3	5131.82	49.8 PK	74.0	-24.2	1.61 H	171	47.5	2.3
4	5131.82	38.1 AV	54.0	-15.9	1.61 H	171	35.8	2.3
5	*5180.00	106.9 PK			1.61 H	171	104.7	2.2
6	*5180.00	95.8 AV			1.61 H	171	93.6	2.2
7	#10360.00	50.8 PK	68.2	-17.4	1.03 H	286	39.0	11.8
8	15540.00	59.1 PK	74.0	-14.9	3.10 H	308	47.3	11.8
9	15540.00	48.7 AV	54.0	-5.3	3.10 H	308	36.9	11.8

Antenna Polarity & Test Distance : Vertical at 3 m

No	Frequency (MHz)	Emission Level (dBuV/m)	Limit (dBuV/m)	Margin (dB)	Antenna Height (m)	Table Angle (Degree)	Raw Value (dBuV)	Correction Factor (dB/m)
1	5146.60	66.6 PK	74.0	-7.4	1.59 V	277	64.3	2.3
2	5146.60	42.1 AV	54.0	-11.9	1.59 V	277	39.8	2.3
3	5150.00	64.8 PK	74.0	-9.2	1.59 V	277	62.5	2.3
4	5150.00	42.7 AV	54.0	-11.3	1.59 V	277	40.4	2.3
5	*5180.00	122.2 PK			1.59 V	277	120.0	2.2
6	*5180.00	110.8 AV			1.59 V	277	108.6	2.2
7	#10360.00	54.5 PK	68.2	-13.7	2.08 V	228	42.7	11.8
8	15540.00	60.4 PK	74.0	-13.6	1.96 V	265	48.6	11.8
9	15540.00	49.8 AV	54.0	-4.2	1.96 V	265	38.0	11.8

Remarks:

1. Emission Level(dBuV/m) = Raw Value(dBuV) + Correction Factor(dB/m)
2. Correction Factor(dB/m) = Antenna Factor(dB/m) + Cable Factor(dB) – Pre-Amplifier Factor(dB)
3. Margin value = Emission Level – Limit value
4. The other emission levels were very low against the limit.
5. " * ": Fundamental frequency.
6. " # ": The radiated frequency is out of the restricted band.

RF Mode	TX 20MHz Preamble 802.11ax (RU26)	Channel	CH 40 : 5200 MHz
Frequency Range	1GHz ~ 40GHz	Detector Function	Peak (PK) Average (AV)

Antenna Polarity & Test Distance : Horizontal at 3 m

No	Frequency (MHz)	Emission Level (dBuV/m)	Limit (dBuV/m)	Margin (dB)	Antenna Height (m)	Table Angle (Degree)	Raw Value (dBuV)	Correction Factor (dB/m)
1	5150.00	50.9 PK	74.0	-23.1	1.56 H	165	48.6	2.3
2	5150.00	37.6 AV	54.0	-16.4	1.56 H	165	35.3	2.3
3	*5200.00	106.7 PK			1.56 H	165	104.6	2.1
4	*5200.00	95.7 AV			1.56 H	165	93.6	2.1
5	#10400.00	50.5 PK	68.2	-17.7	1.06 H	285	38.5	12.0
6	15600.00	59.4 PK	74.0	-14.6	3.15 H	312	47.9	11.5
7	15600.00	48.8 AV	54.0	-5.2	3.15 H	312	37.3	11.5

Antenna Polarity & Test Distance : Vertical at 3 m

No	Frequency (MHz)	Emission Level (dBuV/m)	Limit (dBuV/m)	Margin (dB)	Antenna Height (m)	Table Angle (Degree)	Raw Value (dBuV)	Correction Factor (dB/m)
1	5150.00	53.4 PK	74.0	-20.6	1.58 V	283	51.1	2.3
2	5150.00	39.4 AV	54.0	-14.6	1.58 V	283	37.1	2.3
3	*5200.00	122.6 PK			1.58 V	283	120.5	2.1
4	*5200.00	110.9 AV			1.58 V	283	108.8	2.1
5	#10400.00	53.9 PK	68.2	-14.3	2.03 V	223	41.9	12.0
6	15600.00	60.5 PK	74.0	-13.5	2.01 V	269	49.0	11.5
7	15600.00	50.0 AV	54.0	-4.0	2.01 V	269	38.5	11.5

Remarks:

1. Emission Level(dBuV/m) = Raw Value(dBuV) + Correction Factor(dB/m)
2. Correction Factor(dB/m) = Antenna Factor(dB/m) + Cable Factor(dB) – Pre-Amplifier Factor(dB)
3. Margin value = Emission Level – Limit value
4. The other emission levels were very low against the limit.
5. " * ": Fundamental frequency.
6. " # ": The radiated frequency is out of the restricted band.

RF Mode	TX 20MHz Preamble 802.11ax (RU26)	Channel	CH 48 : 5240 MHz
Frequency Range	1GHz ~ 40GHz	Detector Function	Peak (PK) Average (AV)

Antenna Polarity & Test Distance : Horizontal at 3 m

No	Frequency (MHz)	Emission Level (dBuV/m)	Limit (dBuV/m)	Margin (dB)	Antenna Height (m)	Table Angle (Degree)	Raw Value (dBuV)	Correction Factor (dB/m)
1	5150.00	51.6 PK	74.0	-22.4	1.65 H	183	49.3	2.3
2	5150.00	37.8 AV	54.0	-16.2	1.65 H	183	35.5	2.3
3	*5240.00	107.4 PK			1.65 H	183	105.4	2.0
4	*5240.00	96.1 AV			1.65 H	183	94.1	2.0
5	5350.00	49.8 PK	74.0	-24.2	1.65 H	183	47.9	1.9
6	5350.00	38.2 AV	54.0	-15.8	1.65 H	183	36.3	1.9
7	#10480.00	50.6 PK	68.2	-17.6	1.05 H	286	38.7	11.9
8	15720.00	59.4 PK	74.0	-14.6	3.05 H	313	47.6	11.8
9	15720.00	48.8 AV	54.0	-5.2	3.05 H	313	37.0	11.8

Antenna Polarity & Test Distance : Vertical at 3 m

No	Frequency (MHz)	Emission Level (dBuV/m)	Limit (dBuV/m)	Margin (dB)	Antenna Height (m)	Table Angle (Degree)	Raw Value (dBuV)	Correction Factor (dB/m)
1	5150.00	53.5 PK	74.0	-20.5	1.55 V	264	51.2	2.3
2	5150.00	39.3 AV	54.0	-14.7	1.55 V	264	37.0	2.3
3	*5240.00	122.4 PK			1.55 V	264	120.4	2.0
4	*5240.00	111.1 AV			1.55 V	264	109.1	2.0
5	5350.00	52.9 PK	74.0	-21.1	1.55 V	264	51.0	1.9
6	5350.00	39.0 AV	54.0	-15.0	1.55 V	264	37.1	1.9
7	#10480.00	54.2 PK	68.2	-14.0	2.08 V	235	42.3	11.9
8	15720.00	60.1 PK	74.0	-13.9	1.99 V	253	48.3	11.8
9	15720.00	49.4 AV	54.0	-4.6	1.99 V	253	37.6	11.8

Remarks:

1. Emission Level(dBuV/m) = Raw Value(dBuV) + Correction Factor(dB/m)
2. Correction Factor(dB/m) = Antenna Factor(dB/m) + Cable Factor(dB) – Pre-Amplifier Factor(dB)
3. Margin value = Emission Level – Limit value
4. The other emission levels were very low against the limit.
5. " * ": Fundamental frequency.
6. " # ": The radiated frequency is out of the restricted band.

RF Mode	TX 20MHz Preamble 802.11ax (RU26)	Channel	CH 52 : 5260 MHz
Frequency Range	1GHz ~ 40GHz	Detector Function	Peak (PK) Average (AV)

Antenna Polarity & Test Distance : Horizontal at 3 m

No	Frequency (MHz)	Emission Level (dBuV/m)	Limit (dBuV/m)	Margin (dB)	Antenna Height (m)	Table Angle (Degree)	Raw Value (dBuV)	Correction Factor (dB/m)
1	5150.00	50.4 PK	74.0	-23.6	1.55 H	161	48.1	2.3
2	5150.00	37.1 AV	54.0	-16.9	1.55 H	161	34.8	2.3
3	*5260.00	106.6 PK			1.55 H	161	104.6	2.0
4	*5260.00	95.4 AV			1.55 H	161	93.4	2.0
5	5350.00	49.6 PK	74.0	-24.4	1.55 H	161	47.7	1.9
6	5350.00	37.7 AV	54.0	-16.3	1.55 H	161	35.8	1.9
7	#10520.00	50.6 PK	68.2	-17.6	1.00 H	294	38.6	12.0
8	15780.00	59.3 PK	74.0	-14.7	3.15 H	317	47.8	11.5
9	15780.00	48.8 AV	54.0	-5.2	3.15 H	317	37.3	11.5

Antenna Polarity & Test Distance : Vertical at 3 m

No	Frequency (MHz)	Emission Level (dBuV/m)	Limit (dBuV/m)	Margin (dB)	Antenna Height (m)	Table Angle (Degree)	Raw Value (dBuV)	Correction Factor (dB/m)
1	5150.00	53.8 PK	74.0	-20.2	1.59 V	282	51.5	2.3
2	5150.00	39.7 AV	54.0	-14.3	1.59 V	282	37.4	2.3
3	*5260.00	121.7 PK			1.59 V	282	119.7	2.0
4	*5260.00	110.5 AV			1.59 V	282	108.5	2.0
5	5350.00	52.9 PK	74.0	-21.1	1.59 V	282	51.0	1.9
6	5350.00	39.3 AV	54.0	-14.7	1.59 V	282	37.4	1.9
7	#10520.00	54.4 PK	68.2	-13.8	2.12 V	240	42.4	12.0
8	15780.00	59.8 PK	74.0	-14.2	1.94 V	265	48.3	11.5
9	15780.00	49.5 AV	54.0	-4.5	1.94 V	265	38.0	11.5

Remarks:

1. Emission Level(dBuV/m) = Raw Value(dBuV) + Correction Factor(dB/m)
2. Correction Factor(dB/m) = Antenna Factor(dB/m) + Cable Factor(dB) – Pre-Amplifier Factor(dB)
3. Margin value = Emission Level – Limit value
4. The other emission levels were very low against the limit.
5. " * ": Fundamental frequency.
6. " # ": The radiated frequency is out of the restricted band.

RF Mode	TX 20MHz Preamble 802.11ax (RU26)	Channel	CH 60 : 5300 MHz
Frequency Range	1GHz ~ 40GHz	Detector Function	Peak (PK) Average (AV)

Antenna Polarity & Test Distance : Horizontal at 3 m

No	Frequency (MHz)	Emission Level (dBuV/m)	Limit (dBuV/m)	Margin (dB)	Antenna Height (m)	Table Angle (Degree)	Raw Value (dBuV)	Correction Factor (dB/m)
1	*5300.00	107.3 PK			1.61 H	185	105.6	1.7
2	*5300.00	96.1 AV			1.61 H	185	94.4	1.7
3	5350.00	51.2 PK	74.0	-22.8	1.61 H	185	49.3	1.9
4	5350.00	37.8 AV	54.0	-16.2	1.61 H	185	35.9	1.9
5	10600.00	51.2 PK	74.0	-22.8	1.02 H	270	39.3	11.9
6	10600.00	40.6 AV	54.0	-13.4	1.02 H	270	28.7	11.9
7	15900.00	60.0 PK	74.0	-14.0	3.12 H	312	48.7	11.3
8	15900.00	49.2 AV	54.0	-4.8	3.12 H	312	37.9	11.3

Antenna Polarity & Test Distance : Vertical at 3 m

No	Frequency (MHz)	Emission Level (dBuV/m)	Limit (dBuV/m)	Margin (dB)	Antenna Height (m)	Table Angle (Degree)	Raw Value (dBuV)	Correction Factor (dB/m)
1	*5300.00	121.6 PK			1.61 V	268	119.9	1.7
2	*5300.00	110.4 AV			1.61 V	268	108.7	1.7
3	5350.00	52.8 PK	74.0	-21.2	1.61 V	268	50.9	1.9
4	5350.00	38.9 AV	54.0	-15.1	1.61 V	268	37.0	1.9
5	10600.00	54.1 PK	74.0	-19.9	2.10 V	244	42.2	11.9
6	10600.00	43.6 AV	54.0	-10.4	2.10 V	244	31.7	11.9
7	15900.00	59.9 PK	74.0	-14.1	1.93 V	266	48.6	11.3
8	15900.00	49.4 AV	54.0	-4.6	1.93 V	266	38.1	11.3

Remarks:

1. Emission Level(dBuV/m) = Raw Value(dBuV) + Correction Factor(dB/m)
2. Correction Factor(dB/m) = Antenna Factor(dB/m) + Cable Factor(dB) – Pre-Amplifier Factor(dB)
3. Margin value = Emission Level – Limit value
4. The other emission levels were very low against the limit.
5. " * ": Fundamental frequency.

RF Mode	TX 20MHz Preamble 802.11ax (RU26)	Channel	CH 64 : 5320 MHz
Frequency Range	1GHz ~ 40GHz	Detector Function	Peak (PK) Average (AV)

Antenna Polarity & Test Distance : Horizontal at 3 m

No	Frequency (MHz)	Emission Level (dBuV/m)	Limit (dBuV/m)	Margin (dB)	Antenna Height (m)	Table Angle (Degree)	Raw Value (dBuV)	Correction Factor (dB/m)
1	*5320.00	106.5 PK			1.58 H	165	104.7	1.8
2	*5320.00	95.5 AV			1.58 H	165	93.7	1.8
3	5362.50	50.2 PK	74.0	-23.8	1.58 H	165	48.2	2.0
4	5362.50	37.4 AV	54.0	-16.6	1.58 H	165	35.4	2.0
5	10640.00	50.6 PK	74.0	-23.4	1.08 H	278	38.8	11.8
6	10640.00	40.6 AV	54.0	-13.4	1.08 H	278	28.8	11.8
7	15960.00	59.9 PK	74.0	-14.1	3.18 H	328	48.3	11.6
8	15960.00	49.2 AV	54.0	-4.8	3.18 H	328	37.6	11.6

Antenna Polarity & Test Distance : Vertical at 3 m

No	Frequency (MHz)	Emission Level (dBuV/m)	Limit (dBuV/m)	Margin (dB)	Antenna Height (m)	Table Angle (Degree)	Raw Value (dBuV)	Correction Factor (dB/m)
1	*5320.00	121.1 PK			1.36 V	283	119.3	1.8
2	*5320.00	110.5 AV			1.36 V	283	108.7	1.8
3	5355.60	69.1 PK	74.0	-4.9	1.36 V	283	67.1	2.0
4	5355.60	42.0 AV	54.0	-12.0	1.36 V	283	40.0	2.0
5	5368.00	53.0 PK	74.0	-21.0	1.36 V	283	51.0	2.0
6	5368.00	42.9 AV	54.0	-11.1	1.36 V	283	40.9	2.0
7	10640.00	54.7 PK	74.0	-19.3	2.11 V	239	42.9	11.8
8	10640.00	44.2 AV	54.0	-9.8	2.11 V	239	32.4	11.8
9	15960.00	61.0 PK	74.0	-13.0	1.93 V	279	49.4	11.6
10	15960.00	50.2 AV	54.0	-3.8	1.93 V	279	38.6	11.6

Remarks:

1. Emission Level(dBuV/m) = Raw Value(dBuV) + Correction Factor(dB/m)
2. Correction Factor(dB/m) = Antenna Factor(dB/m) + Cable Factor(dB) – Pre-Amplifier Factor(dB)
3. Margin value = Emission Level – Limit value
4. The other emission levels were very low against the limit.
5. " * ": Fundamental frequency.

RF Mode	TX 20MHz Preamble 802.11ax (RU26)	Channel	CH 100 : 5500 MHz
Frequency Range	1GHz ~ 40GHz	Detector Function	Peak (PK) Average (AV)

Antenna Polarity & Test Distance : Horizontal at 3 m

No	Frequency (MHz)	Emission Level (dBuV/m)	Limit (dBuV/m)	Margin (dB)	Antenna Height (m)	Table Angle (Degree)	Raw Value (dBuV)	Correction Factor (dB/m)
1	5460.00	50.3 PK	74.0	-23.7	1.63 H	169	48.2	2.1
2	5460.00	37.6 AV	54.0	-16.4	1.63 H	169	35.5	2.1
3	#5470.00	49.1 PK	68.2	-19.1	1.63 H	169	46.9	2.2
4	*5500.00	107.4 PK			1.63 H	169	105.3	2.1
5	*5500.00	96.4 AV			1.63 H	169	94.3	2.1
6	11000.00	50.9 PK	74.0	-23.1	1.09 H	292	38.5	12.4
7	11000.00	40.3 AV	54.0	-13.7	1.09 H	292	27.9	12.4
8	#16500.00	59.6 PK	68.2	-8.6	3.12 H	298	45.9	13.7

Antenna Polarity & Test Distance : Vertical at 3 m

No	Frequency (MHz)	Emission Level (dBuV/m)	Limit (dBuV/m)	Margin (dB)	Antenna Height (m)	Table Angle (Degree)	Raw Value (dBuV)	Correction Factor (dB/m)
1	5457.20	61.9 PK	74.0	-12.1	1.60 V	273	59.8	2.1
2	5457.20	43.4 AV	54.0	-10.6	1.60 V	273	41.3	2.1
3	#5467.80	65.9 PK	68.2	-2.3	1.60 V	273	63.7	2.2
4	*5500.00	121.9 PK			1.60 V	273	119.8	2.1
5	*5500.00	111.3 AV			1.60 V	273	109.2	2.1
6	11000.00	54.3 PK	74.0	-19.7	2.08 V	242	41.9	12.4
7	11000.00	44.0 AV	54.0	-10.0	2.08 V	242	31.6	12.4
8	#16500.00	60.7 PK	68.2	-7.5	2.00 V	251	47.0	13.7

Remarks:

1. Emission Level(dBuV/m) = Raw Value(dBuV) + Correction Factor(dB/m)
2. Correction Factor(dB/m) = Antenna Factor(dB/m) + Cable Factor(dB) – Pre-Amplifier Factor(dB)
3. Margin value = Emission Level – Limit value
4. The other emission levels were very low against the limit.
5. " * ": Fundamental frequency.
6. " # ": The radiated frequency is out of the restricted band.

RF Mode	TX 20MHz Preamble 802.11ax (RU26)	Channel	CH 116 : 5580 MHz
Frequency Range	1GHz ~ 40GHz	Detector Function	Peak (PK) Average (AV)

Antenna Polarity & Test Distance : Horizontal at 3 m

No	Frequency (MHz)	Emission Level (dBuV/m)	Limit (dBuV/m)	Margin (dB)	Antenna Height (m)	Table Angle (Degree)	Raw Value (dBuV)	Correction Factor (dB/m)
1	*5580.00	107.3 PK			1.62 H	178	105.2	2.1
2	*5580.00	96.2 AV			1.62 H	178	94.1	2.1
3	11160.00	50.2 PK	74.0	-23.8	1.09 H	295	38.2	12.0
4	11160.00	39.9 AV	54.0	-14.1	1.09 H	295	27.9	12.0
5	#16740.00	59.3 PK	68.2	-8.9	3.20 H	308	44.0	15.3

Antenna Polarity & Test Distance : Vertical at 3 m

No	Frequency (MHz)	Emission Level (dBuV/m)	Limit (dBuV/m)	Margin (dB)	Antenna Height (m)	Table Angle (Degree)	Raw Value (dBuV)	Correction Factor (dB/m)
1	*5580.00	122.9 PK			1.64 V	270	120.8	2.1
2	*5580.00	111.3 AV			1.64 V	270	109.2	2.1
3	11160.00	54.5 PK	74.0	-19.5	2.03 V	237	42.5	12.0
4	11160.00	44.1 AV	54.0	-9.9	2.03 V	237	32.1	12.0
5	#16740.00	60.6 PK	68.2	-7.6	2.00 V	260	45.3	15.3

Remarks:

1. Emission Level(dBuV/m) = Raw Value(dBuV) + Correction Factor(dB/m)
2. Correction Factor(dB/m) = Antenna Factor(dB/m) + Cable Factor(dB) – Pre-Amplifier Factor(dB)
3. Margin value = Emission Level – Limit value
4. The other emission levels were very low against the limit.
5. " * " : Fundamental frequency.
6. " # " : The radiated frequency is out of the restricted band.

RF Mode	TX 20MHz Preamble 802.11ax (RU26)	Channel	CH 140 : 5700 MHz
Frequency Range	1GHz ~ 40GHz	Detector Function	Peak (PK) Average (AV)

Antenna Polarity & Test Distance : Horizontal at 3 m

No	Frequency (MHz)	Emission Level (dBuV/m)	Limit (dBuV/m)	Margin (dB)	Antenna Height (m)	Table Angle (Degree)	Raw Value (dBuV)	Correction Factor (dB/m)
1	*5700.00	106.9 PK			1.61 H	179	104.6	2.3
2	*5700.00	95.9 AV			1.61 H	179	93.6	2.3
3	#5725.00	57.8 PK	68.2	-10.4	1.61 H	179	55.4	2.4
4	11400.00	50.3 PK	74.0	-23.7	1.09 H	292	37.8	12.5
5	11400.00	40.2 AV	54.0	-13.8	1.09 H	292	27.7	12.5
6	#17100.00	59.7 PK	68.2	-8.5	3.19 H	327	42.9	16.8

Antenna Polarity & Test Distance : Vertical at 3 m

No	Frequency (MHz)	Emission Level (dBuV/m)	Limit (dBuV/m)	Margin (dB)	Antenna Height (m)	Table Angle (Degree)	Raw Value (dBuV)	Correction Factor (dB/m)
1	*5700.00	120.8 PK			1.28 V	286	118.5	2.3
2	*5700.00	110.9 AV			1.28 V	286	108.6	2.3
3	#5725.00	66.5 PK	68.2	-1.7	1.28 V	286	64.1	2.4
4	11400.00	54.0 PK	74.0	-20.0	2.08 V	220	41.5	12.5
5	11400.00	43.5 AV	54.0	-10.5	2.08 V	220	31.0	12.5
6	#17100.00	60.1 PK	68.2	-8.1	1.93 V	252	43.3	16.8

Remarks:

1. Emission Level(dBuV/m) = Raw Value(dBuV) + Correction Factor(dB/m)
2. Correction Factor(dB/m) = Antenna Factor(dB/m) + Cable Factor(dB) – Pre-Amplifier Factor(dB)
3. Margin value = Emission Level – Limit value
4. The other emission levels were very low against the limit.
5. " * ": Fundamental frequency.
6. " # ": The radiated frequency is out of the restricted band.

RF Mode	TX 20MHz Preamble 802.11ax (RU26)	Channel	CH 144 : 5720 MHz
Frequency Range	1GHz ~ 40GHz	Detector Function	Peak (PK) Average (AV)

Antenna Polarity & Test Distance : Horizontal at 3 m

No	Frequency (MHz)	Emission Level (dBuV/m)	Limit (dBuV/m)	Margin (dB)	Antenna Height (m)	Table Angle (Degree)	Raw Value (dBuV)	Correction Factor (dB/m)
1	5460.00	51.3 PK	74.0	-22.7	1.58 H	181	49.2	2.1
2	5460.00	37.9 AV	54.0	-16.1	1.58 H	181	35.8	2.1
3	#5470.00	50.2 PK	68.2	-18.0	1.58 H	181	48.0	2.2
4	*5720.00	106.9 PK			1.58 H	181	104.5	2.4
5	*5720.00	95.7 AV			1.58 H	181	93.3	2.4
6	#5850.00	51.8 PK	68.2	-16.4	1.58 H	181	49.1	2.7
7	11440.00	49.9 PK	74.0	-24.1	1.02 H	272	37.5	12.4
8	11440.00	39.8 AV	54.0	-14.2	1.02 H	272	27.4	12.4
9	#17160.00	59.9 PK	68.2	-8.3	3.13 H	308	43.3	16.6

Antenna Polarity & Test Distance : Vertical at 3 m

No	Frequency (MHz)	Emission Level (dBuV/m)	Limit (dBuV/m)	Margin (dB)	Antenna Height (m)	Table Angle (Degree)	Raw Value (dBuV)	Correction Factor (dB/m)
1	5460.00	52.9 PK	74.0	-21.1	1.57 V	280	50.8	2.1
2	5460.00	39.0 AV	54.0	-15.0	1.57 V	280	36.9	2.1
3	#5470.00	53.3 PK	68.2	-14.9	1.57 V	280	51.1	2.2
4	*5720.00	122.5 PK			1.57 V	280	120.1	2.4
5	*5720.00	110.8 AV			1.57 V	280	108.4	2.4
6	#5850.00	52.1 PK	68.2	-16.1	1.57 V	280	49.4	2.7
7	11440.00	54.5 PK	74.0	-19.5	2.10 V	206	42.1	12.4
8	11440.00	43.9 AV	54.0	-10.1	2.10 V	206	31.5	12.4
9	#17160.00	60.1 PK	68.2	-8.1	1.87 V	247	43.5	16.6

Remarks:

1. Emission Level(dBuV/m) = Raw Value(dBuV) + Correction Factor(dB/m)
2. Correction Factor(dB/m) = Antenna Factor(dB/m) + Cable Factor(dB) – Pre-Amplifier Factor(dB)
3. Margin value = Emission Level – Limit value
4. The other emission levels were very low against the limit.
5. " * ": Fundamental frequency.
6. " # ": The radiated frequency is out of the restricted band.

RF Mode	TX 20MHz Preamble 802.11ax (RU26)	Channel	CH 149 : 5745 MHz
Frequency Range	1GHz ~ 40GHz	Detector Function	Peak (PK) Average (AV)

Antenna Polarity & Test Distance : Horizontal at 3 m

No	Frequency (MHz)	Emission Level (dBuV/m)	Limit (dBuV/m)	Margin (dB)	Antenna Height (m)	Table Angle (Degree)	Raw Value (dBuV)	Correction Factor (dB/m)
1	#5609.71	50.2 PK	68.2	-18.0	1.06 H	178	48.1	2.1
2	*5745.00	109.2 PK			1.06 H	178	106.8	2.4
3	*5745.00	99.8 AV			1.06 H	178	97.4	2.4
4	#6005.32	50.7 PK	68.2	-17.5	1.06 H	178	47.8	2.9
5	11490.00	50.9 PK	74.0	-23.1	1.10 H	270	38.3	12.6
6	11490.00	40.5 AV	54.0	-13.5	1.10 H	270	27.9	12.6
7	#17235.00	58.9 PK	68.2	-9.3	3.14 H	314	42.1	16.8

Antenna Polarity & Test Distance : Vertical at 3 m

No	Frequency (MHz)	Emission Level (dBuV/m)	Limit (dBuV/m)	Margin (dB)	Antenna Height (m)	Table Angle (Degree)	Raw Value (dBuV)	Correction Factor (dB/m)
1	#5627.64	52.2 PK	68.2	-16.0	1.35 V	278	49.9	2.3
2	*5745.00	124.5 PK			1.35 V	278	122.1	2.4
3	*5745.00	113.4 AV			1.35 V	278	111.0	2.4
4	#5992.32	50.6 PK	68.2	-17.6	1.35 V	278	47.7	2.9
5	11490.00	54.2 PK	74.0	-19.8	2.08 V	229	41.6	12.6
6	11490.00	43.8 AV	54.0	-10.2	2.08 V	229	31.2	12.6
7	#17235.00	60.2 PK	68.2	-8.0	1.94 V	250	43.4	16.8

Remarks:

1. Emission Level(dBuV/m) = Raw Value(dBuV) + Correction Factor(dB/m)
2. Correction Factor(dB/m) = Antenna Factor(dB/m) + Cable Factor(dB) – Pre-Amplifier Factor(dB)
3. Margin value = Emission Level – Limit value
4. The other emission levels were very low against the limit.
5. " * ": Fundamental frequency.
6. " # ": The radiated frequency is out of the restricted band.

RF Mode	TX 20MHz Preamble 802.11ax (RU26)	Channel	CH 157 : 5785 MHz
Frequency Range	1GHz ~ 40GHz	Detector Function	Peak (PK) Average (AV)

Antenna Polarity & Test Distance : Horizontal at 3 m

No	Frequency (MHz)	Emission Level (dBuV/m)	Limit (dBuV/m)	Margin (dB)	Antenna Height (m)	Table Angle (Degree)	Raw Value (dBuV)	Correction Factor (dB/m)
1	#5623.77	50.8 PK	68.2	-17.4	1.10 H	176	48.7	2.1
2	*5785.00	108.9 PK			1.10 H	176	106.3	2.6
3	*5785.00	99.7 AV			1.10 H	176	97.1	2.6
4	#5925.87	50.5 PK	68.2	-17.7	1.10 H	176	47.6	2.9
5	11570.00	50.3 PK	74.0	-23.7	1.06 H	285	37.7	12.6
6	11570.00	40.1 AV	54.0	-13.9	1.06 H	285	27.5	12.6
7	#17355.00	62.7 PK	68.2	-5.5	3.13 H	301	45.0	17.7

Antenna Polarity & Test Distance : Vertical at 3 m

No	Frequency (MHz)	Emission Level (dBuV/m)	Limit (dBuV/m)	Margin (dB)	Antenna Height (m)	Table Angle (Degree)	Raw Value (dBuV)	Correction Factor (dB/m)
1	#5572.53	51.9 PK	68.2	-16.3	1.49 V	276	49.8	2.1
2	*5785.00	124.6 PK			1.49 V	276	122.0	2.6
3	*5785.00	113.5 AV			1.49 V	276	110.9	2.6
4	#5962.91	51.3 PK	68.2	-16.9	1.49 V	276	48.4	2.9
5	11570.00	53.8 PK	74.0	-20.2	2.06 V	217	41.2	12.6
6	11570.00	43.4 AV	54.0	-10.6	2.06 V	217	30.8	12.6
7	#17355.00	62.9 PK	68.2	-5.3	1.98 V	267	45.2	17.7

Remarks:

1. Emission Level(dBuV/m) = Raw Value(dBuV) + Correction Factor(dB/m)
2. Correction Factor(dB/m) = Antenna Factor(dB/m) + Cable Factor(dB) – Pre-Amplifier Factor(dB)
3. Margin value = Emission Level – Limit value
4. The other emission levels were very low against the limit.
5. " * ": Fundamental frequency.
6. " # ": The radiated frequency is out of the restricted band.

RF Mode	TX 20MHz Preamble 802.11ax (RU26)	Channel	CH 165 : 5825 MHz
Frequency Range	1GHz ~ 40GHz	Detector Function	Peak (PK) Average (AV)

Antenna Polarity & Test Distance : Horizontal at 3 m

No	Frequency (MHz)	Emission Level (dBuV/m)	Limit (dBuV/m)	Margin (dB)	Antenna Height (m)	Table Angle (Degree)	Raw Value (dBuV)	Correction Factor (dB/m)
1	#5590.29	50.3 PK	68.2	-17.9	1.25 H	179	48.2	2.1
2	*5825.00	108.1 PK			1.25 H	179	105.5	2.6
3	*5825.00	98.7 AV			1.25 H	179	96.1	2.6
4	#6023.92	50.6 PK	68.2	-17.6	1.25 H	179	47.6	3.0
5	11650.00	50.2 PK	74.0	-23.8	1.09 H	279	38.0	12.2
6	11650.00	40.0 AV	54.0	-14.0	1.09 H	279	27.8	12.2
7	#17475.00	59.0 PK	68.2	-9.2	3.12 H	314	40.3	18.7

Antenna Polarity & Test Distance : Vertical at 3 m

No	Frequency (MHz)	Emission Level (dBuV/m)	Limit (dBuV/m)	Margin (dB)	Antenna Height (m)	Table Angle (Degree)	Raw Value (dBuV)	Correction Factor (dB/m)
1	#5565.07	51.4 PK	68.2	-16.8	1.51 V	272	49.3	2.1
2	*5825.00	124.3 PK			1.51 V	272	121.7	2.6
3	*5825.00	113.2 AV			1.51 V	272	110.6	2.6
4	#5929.81	50.6 PK	68.2	-17.6	1.51 V	272	47.7	2.9
5	11650.00	54.0 PK	74.0	-20.0	2.06 V	243	41.8	12.2
6	11650.00	43.5 AV	54.0	-10.5	2.06 V	243	31.3	12.2
7	#17475.00	60.9 PK	68.2	-7.3	2.02 V	274	42.2	18.7

Remarks:

1. Emission Level(dBuV/m) = Raw Value(dBuV) + Correction Factor(dB/m)
2. Correction Factor(dB/m) = Antenna Factor(dB/m) + Cable Factor(dB) – Pre-Amplifier Factor(dB)
3. Margin value = Emission Level – Limit value
4. The other emission levels were very low against the limit.
5. " * ": Fundamental frequency.
6. " # ": The radiated frequency is out of the restricted band.

RF Mode	TX 20MHz Preamble 802.11ax (RU52)	Channel	CH 36 : 5180 MHz
Frequency Range	1GHz ~ 40GHz	Detector Function	Peak (PK) Average (AV)

Antenna Polarity & Test Distance : Horizontal at 3 m

No	Frequency (MHz)	Emission Level (dBuV/m)	Limit (dBuV/m)	Margin (dB)	Antenna Height (m)	Table Angle (Degree)	Raw Value (dBuV)	Correction Factor (dB/m)
1	5144.90	53.4 PK	74.0	-20.6	1.69 H	163	51.1	2.3
2	5144.90	39.5 AV	54.0	-14.5	1.69 H	163	37.2	2.3
3	*5180.00	106.6 PK			1.69 H	163	104.4	2.2
4	*5180.00	94.8 AV			1.69 H	163	92.6	2.2
5	#10360.00	47.2 PK	68.2	-21.0	1.02 H	279	35.4	11.8
6	15540.00	58.8 PK	74.0	-15.2	1.30 H	331	47.0	11.8
7	15540.00	45.4 AV	54.0	-8.6	1.30 H	331	33.6	11.8

Antenna Polarity & Test Distance : Vertical at 3 m

No	Frequency (MHz)	Emission Level (dBuV/m)	Limit (dBuV/m)	Margin (dB)	Antenna Height (m)	Table Angle (Degree)	Raw Value (dBuV)	Correction Factor (dB/m)
1	5146.60	69.5 PK	74.0	-4.5	1.70 V	280	67.2	2.3
2	5146.60	43.6 AV	54.0	-10.4	1.70 V	280	41.3	2.3
3	5150.00	61.3 PK	74.0	-12.7	1.70 V	280	59.0	2.3
4	5150.00	45.1 AV	54.0	-8.9	1.70 V	280	42.8	2.3
5	*5180.00	120.8 PK			1.70 V	280	118.6	2.2
6	*5180.00	108.7 AV			1.70 V	280	106.5	2.2
7	#10360.00	48.8 PK	68.2	-19.4	2.00 V	197	37.0	11.8
8	15540.00	56.8 PK	74.0	-17.2	1.44 V	289	45.0	11.8
9	15540.00	43.2 AV	54.0	-10.8	1.44 V	289	31.4	11.8

Remarks:

1. Emission Level(dBuV/m) = Raw Value(dBuV) + Correction Factor(dB/m)
2. Correction Factor(dB/m) = Antenna Factor(dB/m) + Cable Factor(dB) – Pre-Amplifier Factor(dB)
3. Margin value = Emission Level – Limit value
4. The other emission levels were very low against the limit.
5. " * ": Fundamental frequency.
6. " # ": The radiated frequency is out of the restricted band.

RF Mode	TX 20MHz Preamble 802.11ax (RU52)	Channel	CH 40 : 5200 MHz
Frequency Range	1GHz ~ 40GHz	Detector Function	Peak (PK) Average (AV)

Antenna Polarity & Test Distance : Horizontal at 3 m

No	Frequency (MHz)	Emission Level (dBuV/m)	Limit (dBuV/m)	Margin (dB)	Antenna Height (m)	Table Angle (Degree)	Raw Value (dBuV)	Correction Factor (dB/m)
1	5150.00	51.4 PK	74.0	-22.6	1.65 H	171	49.1	2.3
2	5150.00	37.7 AV	54.0	-16.3	1.65 H	171	35.4	2.3
3	*5200.00	106.6 PK			1.65 H	171	104.5	2.1
4	*5200.00	95.0 AV			1.65 H	171	92.9	2.1
5	#10400.00	46.6 PK	68.2	-21.6	1.00 H	266	34.6	12.0
6	15600.00	58.5 PK	74.0	-15.5	1.34 H	337	47.0	11.5
7	15600.00	45.1 AV	54.0	-8.9	1.34 H	337	33.6	11.5

Antenna Polarity & Test Distance : Vertical at 3 m

No	Frequency (MHz)	Emission Level (dBuV/m)	Limit (dBuV/m)	Margin (dB)	Antenna Height (m)	Table Angle (Degree)	Raw Value (dBuV)	Correction Factor (dB/m)
1	5150.00	53.5 PK	74.0	-20.5	1.69 V	287	51.2	2.3
2	5150.00	39.2 AV	54.0	-14.8	1.69 V	287	36.9	2.3
3	*5200.00	120.7 PK			1.69 V	287	118.6	2.1
4	*5200.00	108.4 AV			1.69 V	287	106.3	2.1
5	#10400.00	49.5 PK	68.2	-18.7	2.04 V	187	37.5	12.0
6	15600.00	57.1 PK	74.0	-16.9	1.41 V	304	45.6	11.5
7	15600.00	43.3 AV	54.0	-10.7	1.41 V	304	31.8	11.5

Remarks:

1. Emission Level(dBuV/m) = Raw Value(dBuV) + Correction Factor(dB/m)
2. Correction Factor(dB/m) = Antenna Factor(dB/m) + Cable Factor(dB) – Pre-Amplifier Factor(dB)
3. Margin value = Emission Level – Limit value
4. The other emission levels were very low against the limit.
5. " * ": Fundamental frequency.
6. " # ": The radiated frequency is out of the restricted band.

RF Mode	TX 20MHz Preamble 802.11ax (RU52)	Channel	CH 48 : 5240 MHz
Frequency Range	1GHz ~ 40GHz	Detector Function	Peak (PK) Average (AV)

Antenna Polarity & Test Distance : Horizontal at 3 m

No	Frequency (MHz)	Emission Level (dBuV/m)	Limit (dBuV/m)	Margin (dB)	Antenna Height (m)	Table Angle (Degree)	Raw Value (dBuV)	Correction Factor (dB/m)
1	5150.00	51.1 PK	74.0	-22.9	1.74 H	164	48.8	2.3
2	5150.00	37.6 AV	54.0	-16.4	1.74 H	164	35.3	2.3
3	*5240.00	105.9 PK			1.74 H	164	103.9	2.0
4	*5240.00	94.3 AV			1.74 H	164	92.3	2.0
5	5350.00	49.4 PK	74.0	-24.6	1.74 H	164	47.5	1.9
6	5350.00	38.0 AV	54.0	-16.0	1.74 H	164	36.1	1.9
7	#10480.00	47.5 PK	68.2	-20.7	1.00 H	267	35.6	11.9
8	15720.00	58.8 PK	74.0	-15.2	1.27 H	318	47.0	11.8
9	15720.00	45.7 AV	54.0	-8.3	1.27 H	318	33.9	11.8

Antenna Polarity & Test Distance : Vertical at 3 m

No	Frequency (MHz)	Emission Level (dBuV/m)	Limit (dBuV/m)	Margin (dB)	Antenna Height (m)	Table Angle (Degree)	Raw Value (dBuV)	Correction Factor (dB/m)
1	5150.00	53.9 PK	74.0	-20.1	1.73 V	284	51.6	2.3
2	5150.00	39.5 AV	54.0	-14.5	1.73 V	284	37.2	2.3
3	*5240.00	121.0 PK			1.73 V	284	119.0	2.0
4	*5240.00	108.7 AV			1.73 V	284	106.7	2.0
5	5350.00	52.6 PK	74.0	-21.4	1.73 V	284	50.7	1.9
6	5350.00	38.8 AV	54.0	-15.2	1.73 V	284	36.9	1.9
7	#10480.00	48.8 PK	68.2	-19.4	2.00 V	203	36.9	11.9
8	15720.00	57.4 PK	74.0	-16.6	1.43 V	291	45.6	11.8
9	15720.00	43.7 AV	54.0	-10.3	1.43 V	291	31.9	11.8

Remarks:

1. Emission Level(dBuV/m) = Raw Value(dBuV) + Correction Factor(dB/m)
2. Correction Factor(dB/m) = Antenna Factor(dB/m) + Cable Factor(dB) – Pre-Amplifier Factor(dB)
3. Margin value = Emission Level – Limit value
4. The other emission levels were very low against the limit.
5. " * ": Fundamental frequency.
6. " # ": The radiated frequency is out of the restricted band.

RF Mode	TX 20MHz Preamble 802.11ax (RU52)	Channel	CH 52 : 5260 MHz
Frequency Range	1GHz ~ 40GHz	Detector Function	Peak (PK) Average (AV)

Antenna Polarity & Test Distance : Horizontal at 3 m

No	Frequency (MHz)	Emission Level (dBuV/m)	Limit (dBuV/m)	Margin (dB)	Antenna Height (m)	Table Angle (Degree)	Raw Value (dBuV)	Correction Factor (dB/m)
1	5150.00	50.7 PK	74.0	-23.3	1.71 H	154	48.4	2.3
2	5150.00	36.9 AV	54.0	-17.1	1.71 H	154	34.6	2.3
3	*5260.00	107.1 PK			1.71 H	154	105.1	2.0
4	*5260.00	95.0 AV			1.71 H	154	93.0	2.0
5	5350.00	49.7 PK	74.0	-24.3	1.71 H	154	47.8	1.9
6	5350.00	37.9 AV	54.0	-16.1	1.71 H	154	36.0	1.9
7	#10520.00	46.9 PK	68.2	-21.3	1.08 H	270	34.9	12.0
8	15780.00	58.5 PK	74.0	-15.5	1.25 H	333	47.0	11.5
9	15780.00	45.2 AV	54.0	-8.8	1.25 H	333	33.7	11.5

Antenna Polarity & Test Distance : Vertical at 3 m

No	Frequency (MHz)	Emission Level (dBuV/m)	Limit (dBuV/m)	Margin (dB)	Antenna Height (m)	Table Angle (Degree)	Raw Value (dBuV)	Correction Factor (dB/m)
1	5150.00	53.7 PK	74.0	-20.3	1.67 V	277	51.4	2.3
2	5150.00	39.1 AV	54.0	-14.9	1.67 V	277	36.8	2.3
3	*5260.00	120.9 PK			1.67 V	277	118.9	2.0
4	*5260.00	108.9 AV			1.67 V	277	106.9	2.0
5	5350.00	52.1 PK	74.0	-21.9	1.67 V	277	50.2	1.9
6	5350.00	38.5 AV	54.0	-15.5	1.67 V	277	36.6	1.9
7	#10520.00	49.0 PK	68.2	-19.2	2.02 V	207	37.0	12.0
8	15780.00	56.6 PK	74.0	-17.4	1.50 V	303	45.1	11.5
9	15780.00	42.8 AV	54.0	-11.2	1.50 V	303	31.3	11.5

Remarks:

1. Emission Level(dBuV/m) = Raw Value(dBuV) + Correction Factor(dB/m)
2. Correction Factor(dB/m) = Antenna Factor(dB/m) + Cable Factor(dB) – Pre-Amplifier Factor(dB)
3. Margin value = Emission Level – Limit value
4. The other emission levels were very low against the limit.
5. " * ": Fundamental frequency.
6. " # ": The radiated frequency is out of the restricted band.

RF Mode	TX 20MHz Preamble 802.11ax (RU52)	Channel	CH 60 : 5300 MHz
Frequency Range	1GHz ~ 40GHz	Detector Function	Peak (PK) Average (AV)

Antenna Polarity & Test Distance : Horizontal at 3 m

No	Frequency (MHz)	Emission Level (dBuV/m)	Limit (dBuV/m)	Margin (dB)	Antenna Height (m)	Table Angle (Degree)	Raw Value (dBuV)	Correction Factor (dB/m)
1	*5300.00	106.2 PK			1.74 H	163	104.5	1.7
2	*5300.00	94.3 AV			1.74 H	163	92.6	1.7
3	5350.00	50.6 PK	74.0	-23.4	1.74 H	163	48.7	1.9
4	5350.00	37.0 AV	54.0	-17.0	1.74 H	163	35.1	1.9
5	10600.00	47.0 PK	74.0	-27.0	1.01 H	272	35.1	11.9
6	10600.00	36.7 AV	54.0	-17.3	1.01 H	272	24.8	11.9
7	15900.00	59.3 PK	74.0	-14.7	1.29 H	322	48.0	11.3
8	15900.00	45.8 AV	54.0	-8.2	1.29 H	322	34.5	11.3

Antenna Polarity & Test Distance : Vertical at 3 m

No	Frequency (MHz)	Emission Level (dBuV/m)	Limit (dBuV/m)	Margin (dB)	Antenna Height (m)	Table Angle (Degree)	Raw Value (dBuV)	Correction Factor (dB/m)
1	*5300.00	121.1 PK			1.69 V	283	119.4	1.7
2	*5300.00	108.7 AV			1.69 V	283	107.0	1.7
3	5350.00	54.2 PK	74.0	-19.8	1.69 V	283	52.3	1.9
4	5350.00	39.8 AV	54.0	-14.2	1.69 V	283	37.9	1.9
5	10600.00	49.0 PK	74.0	-25.0	2.04 V	209	37.1	11.9
6	10600.00	39.5 AV	54.0	-14.5	2.04 V	209	27.6	11.9
7	15900.00	56.2 PK	74.0	-17.8	1.46 V	294	44.9	11.3
8	15900.00	42.7 AV	54.0	-11.3	1.46 V	294	31.4	11.3

Remarks:

1. Emission Level(dBuV/m) = Raw Value(dBuV) + Correction Factor(dB/m)
2. Correction Factor(dB/m) = Antenna Factor(dB/m) + Cable Factor(dB) – Pre-Amplifier Factor(dB)
3. Margin value = Emission Level – Limit value
4. The other emission levels were very low against the limit.
5. " * ": Fundamental frequency.

RF Mode	TX 20MHz Preamble 802.11ax (RU52)	Channel	CH 64 : 5320 MHz
Frequency Range	1GHz ~ 40GHz	Detector Function	Peak (PK) Average (AV)

Antenna Polarity & Test Distance : Horizontal at 3 m

No	Frequency (MHz)	Emission Level (dBuV/m)	Limit (dBuV/m)	Margin (dB)	Antenna Height (m)	Table Angle (Degree)	Raw Value (dBuV)	Correction Factor (dB/m)
1	*5320.00	107.4 PK			1.74 H	166	105.6	1.8
2	*5320.00	95.0 AV			1.74 H	166	93.2	1.8
3	5355.10	54.3 PK	74.0	-19.7	1.74 H	166	52.3	2.0
4	5355.10	38.8 AV	54.0	-15.2	1.74 H	166	36.8	2.0
5	10640.00	47.5 PK	74.0	-26.5	1.05 H	277	35.7	11.8
6	10640.00	36.8 AV	54.0	-17.2	1.05 H	277	25.0	11.8
7	15960.00	58.7 PK	74.0	-15.3	1.25 H	338	47.1	11.6
8	15960.00	45.5 AV	54.0	-8.5	1.25 H	338	33.9	11.6

Antenna Polarity & Test Distance : Vertical at 3 m

No	Frequency (MHz)	Emission Level (dBuV/m)	Limit (dBuV/m)	Margin (dB)	Antenna Height (m)	Table Angle (Degree)	Raw Value (dBuV)	Correction Factor (dB/m)
1	*5320.00	120.9 PK			1.50 V	282	119.1	1.8
2	*5320.00	108.7 AV			1.50 V	282	106.9	1.8
3	5353.20	58.8 PK	74.0	-15.2	1.50 V	282	56.9	1.9
4	5353.20	44.9 AV	54.0	-9.1	1.50 V	282	43.0	1.9
5	5356.60	68.3 PK	74.0	-5.7	1.50 V	282	66.3	2.0
6	5356.60	44.3 AV	54.0	-9.7	1.50 V	282	42.3	2.0
7	10640.00	49.2 PK	74.0	-24.8	1.98 V	183	37.4	11.8
8	10640.00	39.2 AV	54.0	-14.8	1.98 V	183	27.4	11.8
9	15960.00	57.1 PK	74.0	-16.9	1.45 V	275	45.5	11.6
10	15960.00	43.3 AV	54.0	-10.7	1.45 V	275	31.7	11.6

Remarks:

1. Emission Level(dBuV/m) = Raw Value(dBuV) + Correction Factor(dB/m)
2. Correction Factor(dB/m) = Antenna Factor(dB/m) + Cable Factor(dB) – Pre-Amplifier Factor(dB)
3. Margin value = Emission Level – Limit value
4. The other emission levels were very low against the limit.
5. " * ": Fundamental frequency.

RF Mode	TX 20MHz Preamble 802.11ax (RU52)	Channel	CH 100 : 5500 MHz
Frequency Range	1GHz ~ 40GHz	Detector Function	Peak (PK) Average (AV)

Antenna Polarity & Test Distance : Horizontal at 3 m

No	Frequency (MHz)	Emission Level (dBuV/m)	Limit (dBuV/m)	Margin (dB)	Antenna Height (m)	Table Angle (Degree)	Raw Value (dBuV)	Correction Factor (dB/m)
1	5411.30	49.7 PK	74.0	-24.3	1.57 H	165	47.7	2.0
2	5411.30	37.6 AV	54.0	-16.4	1.57 H	165	35.6	2.0
3	5460.00	48.5 PK	74.0	-25.5	1.57 H	165	46.4	2.1
4	5460.00	38.2 AV	54.0	-15.8	1.57 H	165	36.1	2.1
5	#5469.90	52.8 PK	68.2	-15.4	1.57 H	165	50.6	2.2
6	*5500.00	105.8 PK			1.57 H	165	103.7	2.1
7	*5500.00	94.7 AV			1.57 H	165	92.6	2.1
8	11000.00	47.5 PK	74.0	-26.5	1.02 H	289	35.1	12.4
9	11000.00	37.2 AV	54.0	-16.8	1.02 H	289	24.8	12.4
10	#16500.00	59.3 PK	68.2	-8.9	1.35 H	336	45.6	13.7

Antenna Polarity & Test Distance : Vertical at 3 m

No	Frequency (MHz)	Emission Level (dBuV/m)	Limit (dBuV/m)	Margin (dB)	Antenna Height (m)	Table Angle (Degree)	Raw Value (dBuV)	Correction Factor (dB/m)
1	5460.00	59.5 PK	74.0	-14.5	1.52 V	279	57.4	2.1
2	5460.00	43.3 AV	54.0	-10.7	1.52 V	279	41.2	2.1
3	#5467.90	65.0 PK	68.2	-3.2	1.52 V	279	62.8	2.2
4	*5500.00	120.5 PK			1.52 V	279	118.4	2.1
5	*5500.00	108.9 AV			1.52 V	279	106.8	2.1
6	11000.00	48.8 PK	74.0	-25.2	2.03 V	210	36.4	12.4
7	11000.00	38.9 AV	54.0	-15.1	2.03 V	210	26.5	12.4
8	#16500.00	57.1 PK	68.2	-11.1	1.41 V	284	43.4	13.7

Remarks:

1. Emission Level(dBuV/m) = Raw Value(dBuV) + Correction Factor(dB/m)
2. Correction Factor(dB/m) = Antenna Factor(dB/m) + Cable Factor(dB) – Pre-Amplifier Factor(dB)
3. Margin value = Emission Level – Limit value
4. The other emission levels were very low against the limit.
5. " * ": Fundamental frequency.
6. " # ": The radiated frequency is out of the restricted band.

RF Mode	TX 20MHz Preamble 802.11ax (RU52)	Channel	CH 116 : 5580 MHz
Frequency Range	1GHz ~ 40GHz	Detector Function	Peak (PK) Average (AV)

Antenna Polarity & Test Distance : Horizontal at 3 m

No	Frequency (MHz)	Emission Level (dBuV/m)	Limit (dBuV/m)	Margin (dB)	Antenna Height (m)	Table Angle (Degree)	Raw Value (dBuV)	Correction Factor (dB/m)
1	*5580.00	106.2 PK			1.67 H	149	104.1	2.1
2	*5580.00	94.5 AV			1.67 H	149	92.4	2.1
3	11160.00	47.5 PK	74.0	-26.5	1.07 H	284	35.5	12.0
4	11160.00	37.1 AV	54.0	-16.9	1.07 H	284	25.1	12.0
5	#16740.00	59.1 PK	68.2	-9.1	1.30 H	320	43.8	15.3

Antenna Polarity & Test Distance : Vertical at 3 m

No	Frequency (MHz)	Emission Level (dBuV/m)	Limit (dBuV/m)	Margin (dB)	Antenna Height (m)	Table Angle (Degree)	Raw Value (dBuV)	Correction Factor (dB/m)
1	*5580.00	120.4 PK			1.74 V	276	118.3	2.1
2	*5580.00	108.4 AV			1.74 V	276	106.3	2.1
3	11160.00	48.6 PK	74.0	-25.4	2.01 V	184	36.6	12.0
4	11160.00	38.8 AV	54.0	-15.2	2.01 V	184	26.8	12.0
5	#16740.00	56.7 PK	68.2	-11.5	1.42 V	303	41.4	15.3

Remarks:

1. Emission Level(dBuV/m) = Raw Value(dBuV) + Correction Factor(dB/m)
2. Correction Factor(dB/m) = Antenna Factor(dB/m) + Cable Factor(dB) – Pre-Amplifier Factor(dB)
3. Margin value = Emission Level – Limit value
4. The other emission levels were very low against the limit.
5. " * " : Fundamental frequency.
6. " # " : The radiated frequency is out of the restricted band.

RF Mode	TX 20MHz Preamble 802.11ax (RU52)	Channel	CH 140 : 5700 MHz
Frequency Range	1GHz ~ 40GHz	Detector Function	Peak (PK) Average (AV)

Antenna Polarity & Test Distance : Horizontal at 3 m

No	Frequency (MHz)	Emission Level (dBuV/m)	Limit (dBuV/m)	Margin (dB)	Antenna Height (m)	Table Angle (Degree)	Raw Value (dBuV)	Correction Factor (dB/m)
1	*5700.00	104.9 PK			1.73 H	173	102.6	2.3
2	*5700.00	92.8 AV			1.73 H	173	90.5	2.3
3	#5725.00	57.6 PK	68.2	-10.6	1.73 H	173	55.2	2.4
4	11400.00	47.0 PK	74.0	-27.0	1.03 H	280	34.5	12.5
5	11400.00	36.5 AV	54.0	-17.5	1.03 H	280	24.0	12.5
6	#17100.00	58.2 PK	68.2	-10.0	1.32 H	335	41.4	16.8

Antenna Polarity & Test Distance : Vertical at 3 m

No	Frequency (MHz)	Emission Level (dBuV/m)	Limit (dBuV/m)	Margin (dB)	Antenna Height (m)	Table Angle (Degree)	Raw Value (dBuV)	Correction Factor (dB/m)
1	*5700.00	118.2 PK			1.49 V	276	115.9	2.3
2	*5700.00	107.1 AV			1.49 V	276	104.8	2.3
3	#5725.00	66.5 PK	68.2	-1.7	1.49 V	276	64.1	2.4
4	11400.00	49.1 PK	74.0	-24.9	2.03 V	189	36.6	12.5
5	11400.00	39.3 AV	54.0	-14.7	2.03 V	189	26.8	12.5
6	#17100.00	56.6 PK	68.2	-11.6	1.49 V	300	39.8	16.8

Remarks:

1. Emission Level(dBuV/m) = Raw Value(dBuV) + Correction Factor(dB/m)
2. Correction Factor(dB/m) = Antenna Factor(dB/m) + Cable Factor(dB) – Pre-Amplifier Factor(dB)
3. Margin value = Emission Level – Limit value
4. The other emission levels were very low against the limit.
5. " * ": Fundamental frequency.
6. " # ": The radiated frequency is out of the restricted band.

RF Mode	TX 20MHz Preamble 802.11ax (RU52)	Channel	CH 144 : 5720 MHz
Frequency Range	1GHz ~ 40GHz	Detector Function	Peak (PK) Average (AV)

Antenna Polarity & Test Distance : Horizontal at 3 m

No	Frequency (MHz)	Emission Level (dBuV/m)	Limit (dBuV/m)	Margin (dB)	Antenna Height (m)	Table Angle (Degree)	Raw Value (dBuV)	Correction Factor (dB/m)
1	5460.00	51.4 PK	74.0	-22.6	1.74 H	156	49.3	2.1
2	5460.00	37.8 AV	54.0	-16.2	1.74 H	156	35.7	2.1
3	#5470.00	50.3 PK	68.2	-17.9	1.74 H	156	48.1	2.2
4	*5720.00	107.1 PK			1.74 H	156	104.7	2.4
5	*5720.00	95.1 AV			1.74 H	156	92.7	2.4
6	#5850.00	52.0 PK	68.2	-16.2	1.74 H	156	49.3	2.7
7	11440.00	47.3 PK	74.0	-26.7	1.04 H	273	34.9	12.4
8	11440.00	36.8 AV	54.0	-17.2	1.04 H	273	24.4	12.4
9	#17160.00	58.2 PK	68.2	-10.0	1.32 H	317	41.6	16.6

Antenna Polarity & Test Distance : Vertical at 3 m

No	Frequency (MHz)	Emission Level (dBuV/m)	Limit (dBuV/m)	Margin (dB)	Antenna Height (m)	Table Angle (Degree)	Raw Value (dBuV)	Correction Factor (dB/m)
1	5460.00	52.8 PK	74.0	-21.2	1.70 V	293	50.7	2.1
2	5460.00	38.8 AV	54.0	-15.2	1.70 V	293	36.7	2.1
3	#5470.00	54.0 PK	68.2	-14.2	1.70 V	293	51.8	2.2
4	*5720.00	120.4 PK			1.70 V	293	118.0	2.4
5	*5720.00	108.4 AV			1.70 V	293	106.0	2.4
6	#5850.00	52.5 PK	68.2	-15.7	1.70 V	293	49.8	2.7
7	11440.00	48.6 PK	74.0	-25.4	1.97 V	210	36.2	12.4
8	11440.00	38.7 AV	54.0	-15.3	1.97 V	210	26.3	12.4
9	#17160.00	57.0 PK	68.2	-11.2	1.40 V	278	40.4	16.6

Remarks:

1. Emission Level(dBuV/m) = Raw Value(dBuV) + Correction Factor(dB/m)
2. Correction Factor(dB/m) = Antenna Factor(dB/m) + Cable Factor(dB) – Pre-Amplifier Factor(dB)
3. Margin value = Emission Level – Limit value
4. The other emission levels were very low against the limit.
5. " * ": Fundamental frequency.
6. " # ": The radiated frequency is out of the restricted band.

RF Mode	TX 20MHz Preamble 802.11ax (RU52)	Channel	CH 149 : 5745 MHz
Frequency Range	1GHz ~ 40GHz	Detector Function	Peak (PK) Average (AV)

Antenna Polarity & Test Distance : Horizontal at 3 m

No	Frequency (MHz)	Emission Level (dBuV/m)	Limit (dBuV/m)	Margin (dB)	Antenna Height (m)	Table Angle (Degree)	Raw Value (dBuV)	Correction Factor (dB/m)
1	#5628.32	50.2 PK	68.2	-18.0	1.24 H	166	47.9	2.3
2	*5745.00	108.9 PK			1.24 H	166	106.5	2.4
3	*5745.00	97.9 AV			1.24 H	166	95.5	2.4
4	#6003.86	51.2 PK	68.2	-17.0	1.24 H	166	48.3	2.9
5	11490.00	47.1 PK	74.0	-26.9	1.01 H	261	34.5	12.6
6	11490.00	36.7 AV	54.0	-17.3	1.01 H	261	24.1	12.6
7	#17235.00	58.5 PK	68.2	-9.7	1.27 H	327	41.7	16.8

Antenna Polarity & Test Distance : Vertical at 3 m

No	Frequency (MHz)	Emission Level (dBuV/m)	Limit (dBuV/m)	Margin (dB)	Antenna Height (m)	Table Angle (Degree)	Raw Value (dBuV)	Correction Factor (dB/m)
1	#5645.83	51.7 PK	68.2	-16.5	1.48 V	275	49.4	2.3
2	*5745.00	121.8 PK			1.48 V	275	119.4	2.4
3	*5745.00	111.6 AV			1.48 V	275	109.2	2.4
4	#6008.02	51.4 PK	68.2	-16.8	1.48 V	275	48.5	2.9
5	11490.00	49.2 PK	74.0	-24.8	2.06 V	190	36.6	12.6
6	11490.00	39.3 AV	54.0	-14.7	2.06 V	190	26.7	12.6
7	#17235.00	56.9 PK	68.2	-11.3	1.42 V	277	40.1	16.8

Remarks:

1. Emission Level(dBuV/m) = Raw Value(dBuV) + Correction Factor(dB/m)
2. Correction Factor(dB/m) = Antenna Factor(dB/m) + Cable Factor(dB) – Pre-Amplifier Factor(dB)
3. Margin value = Emission Level – Limit value
4. The other emission levels were very low against the limit.
5. " * ": Fundamental frequency.
6. " # ": The radiated frequency is out of the restricted band.

RF Mode	TX 20MHz Preamble 802.11ax (RU52)	Channel	CH 157 : 5785 MHz
Frequency Range	1GHz ~ 40GHz	Detector Function	Peak (PK) Average (AV)

Antenna Polarity & Test Distance : Horizontal at 3 m

No	Frequency (MHz)	Emission Level (dBuV/m)	Limit (dBuV/m)	Margin (dB)	Antenna Height (m)	Table Angle (Degree)	Raw Value (dBuV)	Correction Factor (dB/m)
1	#5592.62	51.2 PK	68.2	-17.0	1.28 H	169	49.1	2.1
2	*5785.00	106.6 PK			1.28 H	169	104.0	2.6
3	*5785.00	96.3 AV			1.28 H	169	93.7	2.6
4	#5985.36	50.7 PK	68.2	-17.5	1.28 H	169	47.8	2.9
5	11570.00	47.8 PK	74.0	-26.2	1.06 H	267	35.2	12.6
6	11570.00	37.3 AV	54.0	-16.7	1.06 H	267	24.7	12.6
7	#17355.00	60.7 PK	68.2	-7.5	1.36 H	321	43.0	17.7

Antenna Polarity & Test Distance : Vertical at 3 m

No	Frequency (MHz)	Emission Level (dBuV/m)	Limit (dBuV/m)	Margin (dB)	Antenna Height (m)	Table Angle (Degree)	Raw Value (dBuV)	Correction Factor (dB/m)
1	#5568.39	51.9 PK	68.2	-16.3	1.54 V	275	49.8	2.1
2	*5785.00	121.2 PK			1.54 V	275	118.6	2.6
3	*5785.00	110.8 AV			1.54 V	275	108.2	2.6
4	#5983.44	51.1 PK	68.2	-17.1	1.54 V	275	48.2	2.9
5	11570.00	49.0 PK	74.0	-25.0	2.00 V	206	36.4	12.6
6	11570.00	39.1 AV	54.0	-14.9	2.00 V	206	26.5	12.6
7	#17355.00	58.2 PK	68.2	-10.0	1.47 V	274	40.5	17.7

Remarks:

1. Emission Level(dBuV/m) = Raw Value(dBuV) + Correction Factor(dB/m)
2. Correction Factor(dB/m) = Antenna Factor(dB/m) + Cable Factor(dB) – Pre-Amplifier Factor(dB)
3. Margin value = Emission Level – Limit value
4. The other emission levels were very low against the limit.
5. " * ": Fundamental frequency.
6. " # ": The radiated frequency is out of the restricted band.

RF Mode	TX 20MHz Preamble 802.11ax (RU52)	Channel	CH 165 : 5825 MHz
Frequency Range	1GHz ~ 40GHz	Detector Function	Peak (PK) Average (AV)

Antenna Polarity & Test Distance : Horizontal at 3 m

No	Frequency (MHz)	Emission Level (dBuV/m)	Limit (dBuV/m)	Margin (dB)	Antenna Height (m)	Table Angle (Degree)	Raw Value (dBuV)	Correction Factor (dB/m)
1	#5617.38	50.2 PK	68.2	-18.0	1.25 H	168	48.1	2.1
2	*5825.00	107.9 PK			1.25 H	168	105.3	2.6
3	*5825.00	97.7 AV			1.25 H	168	95.1	2.6
4	#5954.01	50.7 PK	68.2	-17.5	1.25 H	168	47.8	2.9
5	11650.00	47.0 PK	74.0	-27.0	1.02 H	285	34.8	12.2
6	11650.00	36.4 AV	54.0	-17.6	1.02 H	285	24.2	12.2
7	#17475.00	58.4 PK	68.2	-9.8	1.32 H	328	39.7	18.7

Antenna Polarity & Test Distance : Vertical at 3 m

No	Frequency (MHz)	Emission Level (dBuV/m)	Limit (dBuV/m)	Margin (dB)	Antenna Height (m)	Table Angle (Degree)	Raw Value (dBuV)	Correction Factor (dB/m)
1	#5577.50	52.1 PK	68.2	-16.1	1.50 V	282	50.0	2.1
2	*5825.00	121.9 PK			1.50 V	282	119.3	2.6
3	*5825.00	111.7 AV			1.50 V	282	109.1	2.6
4	#5968.08	51.3 PK	68.2	-16.9	1.50 V	282	48.4	2.9
5	11650.00	48.9 PK	74.0	-25.1	2.02 V	196	36.7	12.2
6	11650.00	39.2 AV	54.0	-14.8	2.02 V	196	27.0	12.2
7	#17475.00	57.3 PK	68.2	-10.9	1.46 V	281	38.6	18.7

Remarks:

- Emission Level(dBuV/m) = Raw Value(dBuV) + Correction Factor(dB/m)
- Correction Factor(dB/m) = Antenna Factor(dB/m) + Cable Factor(dB) – Pre-Amplifier Factor(dB)
- Margin value = Emission Level – Limit value
- The other emission levels were very low against the limit.
- " * ": Fundamental frequency.
- " # ": The radiated frequency is out of the restricted band.

RF Mode	TX 20MHz Preamble 802.11ax (RU106)	Channel	CH 36 : 5180 MHz
Frequency Range	1GHz ~ 40GHz	Detector Function	Peak (PK) Average (AV)

Antenna Polarity & Test Distance : Horizontal at 3 m

No	Frequency (MHz)	Emission Level (dBuV/m)	Limit (dBuV/m)	Margin (dB)	Antenna Height (m)	Table Angle (Degree)	Raw Value (dBuV)	Correction Factor (dB/m)
1	5150.00	62.1 PK	74.0	-11.9	1.70 H	184	59.8	2.3
2	5150.00	38.4 AV	54.0	-15.6	1.70 H	184	36.1	2.3
3	*5180.00	104.5 PK			1.70 H	184	102.3	2.2
4	*5180.00	93.1 AV			1.70 H	184	90.9	2.2
5	#10360.00	46.9 PK	68.2	-21.3	1.08 H	295	35.1	11.8
6	15540.00	58.2 PK	74.0	-15.8	3.09 H	292	46.4	11.8
7	15540.00	45.3 AV	54.0	-8.7	3.09 H	292	33.5	11.8

Antenna Polarity & Test Distance : Vertical at 3 m

No	Frequency (MHz)	Emission Level (dBuV/m)	Limit (dBuV/m)	Margin (dB)	Antenna Height (m)	Table Angle (Degree)	Raw Value (dBuV)	Correction Factor (dB/m)
1	5137.10	54.6 PK	74.0	-19.4	1.66 V	282	52.3	2.3
2	5137.10	44.2 AV	54.0	-9.8	1.66 V	282	41.9	2.3
3	5149.40	72.0 PK	74.0	-2.0	1.66 V	282	69.7	2.3
4	5149.40	43.3 AV	54.0	-10.7	1.66 V	282	41.0	2.3
5	*5180.00	118.2 PK			1.66 V	282	116.0	2.2
6	*5180.00	106.5 AV			1.66 V	282	104.3	2.2
7	#10360.00	49.7 PK	68.2	-18.5	2.05 V	240	37.9	11.8
8	15540.00	57.3 PK	74.0	-16.7	2.02 V	251	45.5	11.8
9	15540.00	44.2 AV	54.0	-9.8	2.02 V	251	32.4	11.8

Remarks:

1. Emission Level(dBuV/m) = Raw Value(dBuV) + Correction Factor(dB/m)
2. Correction Factor(dB/m) = Antenna Factor(dB/m) + Cable Factor(dB) – Pre-Amplifier Factor(dB)
3. Margin value = Emission Level – Limit value
4. The other emission levels were very low against the limit.
5. " * ": Fundamental frequency.
6. " # ": The radiated frequency is out of the restricted band.

RF Mode	TX 20MHz Preamble 802.11ax (RU106)	Channel	CH 40 : 5200 MHz
Frequency Range	1GHz ~ 40GHz	Detector Function	Peak (PK) Average (AV)

Antenna Polarity & Test Distance : Horizontal at 3 m

No	Frequency (MHz)	Emission Level (dBuV/m)	Limit (dBuV/m)	Margin (dB)	Antenna Height (m)	Table Angle (Degree)	Raw Value (dBuV)	Correction Factor (dB/m)
1	5150.00	50.2 PK	74.0	-23.8	1.72 H	189	47.9	2.3
2	5150.00	36.6 AV	54.0	-17.4	1.72 H	189	34.3	2.3
3	*5200.00	104.8 PK			1.72 H	189	102.7	2.1
4	*5200.00	93.5 AV			1.72 H	189	91.4	2.1
5	#10400.00	47.3 PK	68.2	-20.9	1.08 H	268	35.3	12.0
6	15600.00	59.5 PK	74.0	-14.5	3.05 H	290	48.0	11.5
7	15600.00	46.0 AV	54.0	-8.0	3.05 H	290	34.5	11.5

Antenna Polarity & Test Distance : Vertical at 3 m

No	Frequency (MHz)	Emission Level (dBuV/m)	Limit (dBuV/m)	Margin (dB)	Antenna Height (m)	Table Angle (Degree)	Raw Value (dBuV)	Correction Factor (dB/m)
1	5150.00	53.8 PK	74.0	-20.2	1.60 V	277	51.5	2.3
2	5150.00	39.2 AV	54.0	-14.8	1.60 V	277	36.9	2.3
3	*5200.00	118.5 PK			1.60 V	277	116.4	2.1
4	*5200.00	106.7 AV			1.60 V	277	104.6	2.1
5	#10400.00	50.1 PK	68.2	-18.1	2.04 V	255	38.1	12.0
6	15600.00	57.5 PK	74.0	-16.5	2.00 V	264	46.0	11.5
7	15600.00	44.7 AV	54.0	-9.3	2.00 V	264	33.2	11.5

Remarks:

1. Emission Level(dBuV/m) = Raw Value(dBuV) + Correction Factor(dB/m)
2. Correction Factor(dB/m) = Antenna Factor(dB/m) + Cable Factor(dB) – Pre-Amplifier Factor(dB)
3. Margin value = Emission Level – Limit value
4. The other emission levels were very low against the limit.
5. " * ": Fundamental frequency.
6. " # ": The radiated frequency is out of the restricted band.

RF Mode	TX 20MHz Preamble 802.11ax (RU106)	Channel	CH 48 : 5240 MHz
Frequency Range	1GHz ~ 40GHz	Detector Function	Peak (PK) Average (AV)

Antenna Polarity & Test Distance : Horizontal at 3 m

No	Frequency (MHz)	Emission Level (dBuV/m)	Limit (dBuV/m)	Margin (dB)	Antenna Height (m)	Table Angle (Degree)	Raw Value (dBuV)	Correction Factor (dB/m)
1	5150.00	51.3 PK	74.0	-22.7	1.71 H	177	49.0	2.3
2	5150.00	37.4 AV	54.0	-16.6	1.71 H	177	35.1	2.3
3	*5240.00	104.1 PK			1.71 H	177	102.1	2.0
4	*5240.00	92.9 AV			1.71 H	177	90.9	2.0
5	5350.00	49.6 PK	74.0	-24.4	1.71 H	177	47.7	1.9
6	5350.00	37.6 AV	54.0	-16.4	1.71 H	177	35.7	1.9
7	#10480.00	47.2 PK	68.2	-21.0	1.05 H	309	35.3	11.9
8	15720.00	58.1 PK	74.0	-15.9	3.06 H	281	46.3	11.8
9	15720.00	45.4 AV	54.0	-8.6	3.06 H	281	33.6	11.8

Antenna Polarity & Test Distance : Vertical at 3 m

No	Frequency (MHz)	Emission Level (dBuV/m)	Limit (dBuV/m)	Margin (dB)	Antenna Height (m)	Table Angle (Degree)	Raw Value (dBuV)	Correction Factor (dB/m)
1	5150.00	53.8 PK	74.0	-20.2	1.67 V	289	51.5	2.3
2	5150.00	39.7 AV	54.0	-14.3	1.67 V	289	37.4	2.3
3	*5240.00	118.0 PK			1.67 V	289	116.0	2.0
4	*5240.00	106.2 AV			1.67 V	289	104.2	2.0
5	5350.00	53.3 PK	74.0	-20.7	1.67 V	289	51.4	1.9
6	5350.00	39.2 AV	54.0	-14.8	1.67 V	289	37.3	1.9
7	#10480.00	49.5 PK	68.2	-18.7	2.07 V	239	37.6	11.9
8	15720.00	56.8 PK	74.0	-17.2	1.99 V	244	45.0	11.8
9	15720.00	43.9 AV	54.0	-10.1	1.99 V	244	32.1	11.8

Remarks:

1. Emission Level(dBuV/m) = Raw Value(dBuV) + Correction Factor(dB/m)
2. Correction Factor(dB/m) = Antenna Factor(dB/m) + Cable Factor(dB) – Pre-Amplifier Factor(dB)
3. Margin value = Emission Level – Limit value
4. The other emission levels were very low against the limit.
5. " * ": Fundamental frequency.
6. " # ": The radiated frequency is out of the restricted band.

RF Mode	TX 20MHz Preamble 802.11ax (RU106)	Channel	CH 52 : 5260 MHz
Frequency Range	1GHz ~ 40GHz	Detector Function	Peak (PK) Average (AV)

Antenna Polarity & Test Distance : Horizontal at 3 m

No	Frequency (MHz)	Emission Level (dBuV/m)	Limit (dBuV/m)	Margin (dB)	Antenna Height (m)	Table Angle (Degree)	Raw Value (dBuV)	Correction Factor (dB/m)
1	5150.00	50.4 PK	74.0	-23.6	1.69 H	198	48.1	2.3
2	5150.00	36.9 AV	54.0	-17.1	1.69 H	198	34.6	2.3
3	*5260.00	104.6 PK			1.69 H	198	102.6	2.0
4	*5260.00	93.3 AV			1.69 H	198	91.3	2.0
5	5350.00	49.8 PK	74.0	-24.2	1.69 H	198	47.9	1.9
6	5350.00	37.8 AV	54.0	-16.2	1.69 H	198	35.9	1.9
7	#10520.00	46.9 PK	68.2	-21.3	1.11 H	303	34.9	12.0
8	15780.00	58.2 PK	74.0	-15.8	3.14 H	304	46.7	11.5
9	15780.00	45.6 AV	54.0	-8.4	3.14 H	304	34.1	11.5

Antenna Polarity & Test Distance : Vertical at 3 m

No	Frequency (MHz)	Emission Level (dBuV/m)	Limit (dBuV/m)	Margin (dB)	Antenna Height (m)	Table Angle (Degree)	Raw Value (dBuV)	Correction Factor (dB/m)
1	5150.00	54.4 PK	74.0	-19.6	1.60 V	272	52.1	2.3
2	5150.00	39.7 AV	54.0	-14.3	1.60 V	272	37.4	2.3
3	*5260.00	118.0 PK			1.60 V	272	116.0	2.0
4	*5260.00	106.5 AV			1.60 V	272	104.5	2.0
5	5350.00	52.7 PK	74.0	-21.3	1.60 V	272	50.8	1.9
6	5350.00	39.0 AV	54.0	-15.0	1.60 V	272	37.1	1.9
7	#10520.00	49.2 PK	68.2	-19.0	2.02 V	254	37.2	12.0
8	15780.00	57.8 PK	74.0	-16.2	1.97 V	260	46.3	11.5
9	15780.00	44.6 AV	54.0	-9.4	1.97 V	260	33.1	11.5

Remarks:

1. Emission Level(dBuV/m) = Raw Value(dBuV) + Correction Factor(dB/m)
2. Correction Factor(dB/m) = Antenna Factor(dB/m) + Cable Factor(dB) – Pre-Amplifier Factor(dB)
3. Margin value = Emission Level – Limit value
4. The other emission levels were very low against the limit.
5. " * ": Fundamental frequency.
6. " # ": The radiated frequency is out of the restricted band.

RF Mode	TX 20MHz Preamble 802.11ax (RU106)	Channel	CH 60 : 5300 MHz
Frequency Range	1GHz ~ 40GHz	Detector Function	Peak (PK) Average (AV)

Antenna Polarity & Test Distance : Horizontal at 3 m

No	Frequency (MHz)	Emission Level (dBuV/m)	Limit (dBuV/m)	Margin (dB)	Antenna Height (m)	Table Angle (Degree)	Raw Value (dBuV)	Correction Factor (dB/m)
1	*5300.00	104.1 PK			1.74 H	195	102.4	1.7
2	*5300.00	92.8 AV			1.74 H	195	91.1	1.7
3	5350.00	51.1 PK	74.0	-22.9	1.74 H	195	49.2	1.9
4	5350.00	37.2 AV	54.0	-16.8	1.74 H	195	35.3	1.9
5	10600.00	46.9 PK	74.0	-27.1	1.03 H	281	35.0	11.9
6	10600.00	37.0 AV	54.0	-17.0	1.03 H	281	25.1	11.9
7	15900.00	58.6 PK	74.0	-15.4	3.06 H	289	47.3	11.3
8	15900.00	45.7 AV	54.0	-8.3	3.06 H	289	34.4	11.3

Antenna Polarity & Test Distance : Vertical at 3 m

No	Frequency (MHz)	Emission Level (dBuV/m)	Limit (dBuV/m)	Margin (dB)	Antenna Height (m)	Table Angle (Degree)	Raw Value (dBuV)	Correction Factor (dB/m)
1	*5300.00	118.4 PK			1.71 V	266	116.7	1.7
2	*5300.00	106.7 AV			1.71 V	266	105.0	1.7
3	5350.00	53.3 PK	74.0	-20.7	1.71 V	266	51.4	1.9
4	5350.00	39.2 AV	54.0	-14.8	1.71 V	266	37.3	1.9
5	10600.00	49.6 PK	74.0	-24.4	2.04 V	251	37.7	11.9
6	10600.00	39.9 AV	54.0	-14.1	2.04 V	251	28.0	11.9
7	15900.00	57.2 PK	74.0	-16.8	2.05 V	261	45.9	11.3
8	15900.00	44.2 AV	54.0	-9.8	2.05 V	261	32.9	11.3

Remarks:

1. Emission Level(dBuV/m) = Raw Value(dBuV) + Correction Factor(dB/m)
2. Correction Factor(dB/m) = Antenna Factor(dB/m) + Cable Factor(dB) – Pre-Amplifier Factor(dB)
3. Margin value = Emission Level – Limit value
4. The other emission levels were very low against the limit.
5. " * ": Fundamental frequency.

RF Mode	TX 20MHz Preamble 802.11ax (RU106)	Channel	CH 64 : 5320 MHz
Frequency Range	1GHz ~ 40GHz	Detector Function	Peak (PK) Average (AV)

Antenna Polarity & Test Distance : Horizontal at 3 m

No	Frequency (MHz)	Emission Level (dBuV/m)	Limit (dBuV/m)	Margin (dB)	Antenna Height (m)	Table Angle (Degree)	Raw Value (dBuV)	Correction Factor (dB/m)
1	*5320.00	103.6 PK			1.65 H	179	101.8	1.8
2	*5320.00	92.7 AV			1.65 H	179	90.9	1.8
3	5350.00	67.0 PK	74.0	-7.0	1.65 H	179	65.1	1.9
4	5350.00	38.0 AV	54.0	-16.0	1.65 H	179	36.1	1.9
5	10640.00	46.4 PK	74.0	-27.6	1.08 H	310	34.6	11.8
6	10640.00	36.5 AV	54.0	-17.5	1.08 H	310	24.7	11.8
7	15960.00	58.0 PK	74.0	-16.0	3.12 H	288	46.4	11.6
8	15960.00	45.3 AV	54.0	-8.7	3.12 H	288	33.7	11.6

Antenna Polarity & Test Distance : Vertical at 3 m

No	Frequency (MHz)	Emission Level (dBuV/m)	Limit (dBuV/m)	Margin (dB)	Antenna Height (m)	Table Angle (Degree)	Raw Value (dBuV)	Correction Factor (dB/m)
1	*5320.00	117.1 PK			1.59 V	283	115.3	1.8
2	*5320.00	105.7 AV			1.59 V	283	103.9	1.8
3	5350.00	72.5 PK	74.0	-1.5	1.59 V	283	70.6	1.9
4	5350.00	44.4 AV	54.0	-9.6	1.59 V	283	42.5	1.9
5	10640.00	49.5 PK	74.0	-24.5	2.06 V	245	37.7	11.8
6	10640.00	39.8 AV	54.0	-14.2	2.06 V	245	28.0	11.8
7	15960.00	58.0 PK	74.0	-16.0	2.08 V	256	46.4	11.6
8	15960.00	44.6 AV	54.0	-9.4	2.08 V	256	33.0	11.6

Remarks:

1. Emission Level(dBuV/m) = Raw Value(dBuV) + Correction Factor(dB/m)
2. Correction Factor(dB/m) = Antenna Factor(dB/m) + Cable Factor(dB) – Pre-Amplifier Factor(dB)
3. Margin value = Emission Level – Limit value
4. The other emission levels were very low against the limit.
5. " * ": Fundamental frequency.

RF Mode	TX 20MHz Preamble 802.11ax (RU106)	Channel	CH 100 : 5500 MHz
Frequency Range	1GHz ~ 40GHz	Detector Function	Peak (PK) Average (AV)

Antenna Polarity & Test Distance : Horizontal at 3 m

No	Frequency (MHz)	Emission Level (dBuV/m)	Limit (dBuV/m)	Margin (dB)	Antenna Height (m)	Table Angle (Degree)	Raw Value (dBuV)	Correction Factor (dB/m)
1	5453.70	53.1 PK	74.0	-20.9	2.01 H	155	51.0	2.1
2	5453.70	37.7 AV	54.0	-16.3	2.01 H	155	35.6	2.1
3	#5470.00	55.3 PK	68.2	-12.9	2.01 H	155	53.1	2.2
4	*5500.00	103.5 PK			2.01 H	155	101.4	2.1
5	*5500.00	92.3 AV			2.01 H	155	90.2	2.1
6	11000.00	47.3 PK	74.0	-26.7	1.04 H	299	34.9	12.4
7	11000.00	37.3 AV	54.0	-16.7	1.04 H	299	24.9	12.4
8	#16500.00	57.9 PK	68.2	-10.3	3.09 H	299	44.2	13.7

Antenna Polarity & Test Distance : Vertical at 3 m

No	Frequency (MHz)	Emission Level (dBuV/m)	Limit (dBuV/m)	Margin (dB)	Antenna Height (m)	Table Angle (Degree)	Raw Value (dBuV)	Correction Factor (dB/m)
1	5458.20	53.3 PK	74.0	-20.7	1.62 V	277	51.2	2.1
2	5458.20	42.7 AV	54.0	-11.3	1.62 V	277	40.6	2.1
3	#5467.20	66.5 PK	68.2	-1.7	1.62 V	277	64.3	2.2
4	*5500.00	117.2 PK			1.62 V	277	115.1	2.1
5	*5500.00	105.6 AV			1.62 V	277	103.5	2.1
6	11000.00	49.9 PK	74.0	-24.1	2.08 V	248	37.5	12.4
7	11000.00	40.3 AV	54.0	-13.7	2.08 V	248	27.9	12.4
8	#16500.00	58.3 PK	68.2	-9.9	2.07 V	243	44.6	13.7

Remarks:

1. Emission Level(dBuV/m) = Raw Value(dBuV) + Correction Factor(dB/m)
2. Correction Factor(dB/m) = Antenna Factor(dB/m) + Cable Factor(dB) – Pre-Amplifier Factor(dB)
3. Margin value = Emission Level – Limit value
4. The other emission levels were very low against the limit.
5. " * ": Fundamental frequency.
6. " # ": The radiated frequency is out of the restricted band.

RF Mode	TX 20MHz Preamble 802.11ax (RU106)	Channel	CH 116 : 5580 MHz
Frequency Range	1GHz ~ 40GHz	Detector Function	Peak (PK) Average (AV)

Antenna Polarity & Test Distance : Horizontal at 3 m

No	Frequency (MHz)	Emission Level (dBuV/m)	Limit (dBuV/m)	Margin (dB)	Antenna Height (m)	Table Angle (Degree)	Raw Value (dBuV)	Correction Factor (dB/m)
1	*5580.00	104.4 PK			1.71 H	183	102.3	2.1
2	*5580.00	93.2 AV			1.71 H	183	91.1	2.1
3	11160.00	47.1 PK	74.0	-26.9	1.07 H	297	35.1	12.0
4	11160.00	36.9 AV	54.0	-17.1	1.07 H	297	24.9	12.0
5	#16740.00	58.1 PK	68.2	-10.1	3.12 H	286	42.8	15.3

Antenna Polarity & Test Distance : Vertical at 3 m

No	Frequency (MHz)	Emission Level (dBuV/m)	Limit (dBuV/m)	Margin (dB)	Antenna Height (m)	Table Angle (Degree)	Raw Value (dBuV)	Correction Factor (dB/m)
1	*5580.00	117.8 PK			1.63 V	290	115.7	2.1
2	*5580.00	106.3 AV			1.63 V	290	104.2	2.1
3	11160.00	50.1 PK	74.0	-23.9	2.08 V	248	38.1	12.0
4	11160.00	40.1 AV	54.0	-13.9	2.08 V	248	28.1	12.0
5	#16740.00	57.5 PK	68.2	-10.7	2.07 V	248	42.2	15.3

Remarks:

1. Emission Level(dBuV/m) = Raw Value(dBuV) + Correction Factor(dB/m)
2. Correction Factor(dB/m) = Antenna Factor(dB/m) + Cable Factor(dB) – Pre-Amplifier Factor(dB)
3. Margin value = Emission Level – Limit value
4. The other emission levels were very low against the limit.
5. " * ": Fundamental frequency.
6. " # ": The radiated frequency is out of the restricted band.

RF Mode	TX 20MHz Preamble 802.11ax (RU106)	Channel	CH 140 : 5700 MHz
Frequency Range	1GHz ~ 40GHz	Detector Function	Peak (PK) Average (AV)

Antenna Polarity & Test Distance : Horizontal at 3 m

No	Frequency (MHz)	Emission Level (dBuV/m)	Limit (dBuV/m)	Margin (dB)	Antenna Height (m)	Table Angle (Degree)	Raw Value (dBuV)	Correction Factor (dB/m)
1	*5700.00	102.9 PK			1.98 H	167	100.6	2.3
2	*5700.00	91.8 AV			1.98 H	167	89.5	2.3
3	#5725.00	56.4 PK	68.2	-11.8	1.98 H	167	54.0	2.4
4	11400.00	46.5 PK	74.0	-27.5	1.11 H	285	34.0	12.5
5	11400.00	36.7 AV	54.0	-17.3	1.11 H	285	24.2	12.5
6	#17100.00	57.9 PK	68.2	-10.3	3.06 H	277	41.1	16.8

Antenna Polarity & Test Distance : Vertical at 3 m

No	Frequency (MHz)	Emission Level (dBuV/m)	Limit (dBuV/m)	Margin (dB)	Antenna Height (m)	Table Angle (Degree)	Raw Value (dBuV)	Correction Factor (dB/m)
1	*5700.00	117.5 PK			1.63 V	298	115.2	2.3
2	*5700.00	105.8 AV			1.63 V	298	103.5	2.3
3	#5725.00	66.6 PK	68.2	-1.6	1.63 V	298	64.2	2.4
4	11400.00	49.5 PK	74.0	-24.5	2.01 V	244	37.0	12.5
5	11400.00	39.5 AV	54.0	-14.5	2.01 V	244	27.0	12.5
6	#17100.00	56.8 PK	68.2	-11.4	2.06 V	260	40.0	16.8

Remarks:

1. Emission Level(dBuV/m) = Raw Value(dBuV) + Correction Factor(dB/m)
2. Correction Factor(dB/m) = Antenna Factor(dB/m) + Cable Factor(dB) – Pre-Amplifier Factor(dB)
3. Margin value = Emission Level – Limit value
4. The other emission levels were very low against the limit.
5. " * ": Fundamental frequency.
6. " # ": The radiated frequency is out of the restricted band.

RF Mode	TX 20MHz Preamble 802.11ax (RU106)	Channel	CH 144 : 5720 MHz
Frequency Range	1GHz ~ 40GHz	Detector Function	Peak (PK) Average (AV)

Antenna Polarity & Test Distance : Horizontal at 3 m

No	Frequency (MHz)	Emission Level (dBuV/m)	Limit (dBuV/m)	Margin (dB)	Antenna Height (m)	Table Angle (Degree)	Raw Value (dBuV)	Correction Factor (dB/m)
1	5460.00	51.3 PK	74.0	-22.7	1.66 H	172	49.2	2.1
2	5460.00	37.8 AV	54.0	-16.2	1.66 H	172	35.7	2.1
3	#5470.00	49.9 PK	68.2	-18.3	1.66 H	172	47.7	2.2
4	*5720.00	104.4 PK			1.66 H	172	102.0	2.4
5	*5720.00	92.8 AV			1.66 H	172	90.4	2.4
6	#5850.00	51.5 PK	68.2	-16.7	1.66 H	172	48.8	2.7
7	11440.00	46.9 PK	74.0	-27.1	1.10 H	304	34.5	12.4
8	11440.00	36.8 AV	54.0	-17.2	1.10 H	304	24.4	12.4
9	#17160.00	58.5 PK	68.2	-9.7	3.06 H	305	41.9	16.6

Antenna Polarity & Test Distance : Vertical at 3 m

No	Frequency (MHz)	Emission Level (dBuV/m)	Limit (dBuV/m)	Margin (dB)	Antenna Height (m)	Table Angle (Degree)	Raw Value (dBuV)	Correction Factor (dB/m)
1	5460.00	52.7 PK	74.0	-21.3	1.65 V	294	50.6	2.1
2	5460.00	38.5 AV	54.0	-15.5	1.65 V	294	36.4	2.1
3	#5470.00	54.6 PK	68.2	-13.6	1.65 V	294	52.4	2.2
4	*5720.00	118.3 PK			1.65 V	294	115.9	2.4
5	*5720.00	106.5 AV			1.65 V	294	104.1	2.4
6	#5850.00	52.3 PK	68.2	-15.9	1.65 V	294	49.6	2.7
7	11440.00	49.8 PK	74.0	-24.2	2.11 V	231	37.4	12.4
8	11440.00	40.1 AV	54.0	-13.9	2.11 V	231	27.7	12.4
9	#17160.00	56.6 PK	68.2	-11.6	1.97 V	261	40.0	16.6

Remarks:

1. Emission Level(dBuV/m) = Raw Value(dBuV) + Correction Factor(dB/m)
2. Correction Factor(dB/m) = Antenna Factor(dB/m) + Cable Factor(dB) – Pre-Amplifier Factor(dB)
3. Margin value = Emission Level – Limit value
4. The other emission levels were very low against the limit.
5. " * ": Fundamental frequency.
6. " # ": The radiated frequency is out of the restricted band.

RF Mode	TX 20MHz Preamble 802.11ax (RU106)	Channel	CH 149 : 5745 MHz
Frequency Range	1GHz ~ 40GHz	Detector Function	Peak (PK) Average (AV)

Antenna Polarity & Test Distance : Horizontal at 3 m

No	Frequency (MHz)	Emission Level (dBuV/m)	Limit (dBuV/m)	Margin (dB)	Antenna Height (m)	Table Angle (Degree)	Raw Value (dBuV)	Correction Factor (dB/m)
1	#5587.60	50.0 PK	68.2	-18.2	2.93 H	123	47.9	2.1
2	*5745.00	109.9 PK			2.93 H	123	107.5	2.4
3	*5745.00	99.1 AV			2.93 H	123	96.7	2.4
4	#5938.72	50.6 PK	68.2	-17.6	2.93 H	123	47.7	2.9
5	11490.00	46.4 PK	74.0	-27.6	1.08 H	300	33.8	12.6
6	11490.00	36.4 AV	54.0	-17.6	1.08 H	300	23.8	12.6
7	#17235.00	58.7 PK	68.2	-9.5	3.06 H	280	41.9	16.8

Antenna Polarity & Test Distance : Vertical at 3 m

No	Frequency (MHz)	Emission Level (dBuV/m)	Limit (dBuV/m)	Margin (dB)	Antenna Height (m)	Table Angle (Degree)	Raw Value (dBuV)	Correction Factor (dB/m)
1	#5642.95	51.9 PK	68.2	-16.3	1.50 V	275	49.6	2.3
2	*5745.00	119.9 PK			1.50 V	275	117.5	2.4
3	*5745.00	109.3 AV			1.50 V	275	106.9	2.4
4	#5955.33	51.5 PK	68.2	-16.7	1.50 V	275	48.6	2.9
5	11490.00	49.7 PK	74.0	-24.3	2.04 V	240	37.1	12.6
6	11490.00	39.8 AV	54.0	-14.2	2.04 V	240	27.2	12.6
7	#17235.00	57.1 PK	68.2	-11.1	2.07 V	264	40.3	16.8

Remarks:

1. Emission Level(dBuV/m) = Raw Value(dBuV) + Correction Factor(dB/m)
2. Correction Factor(dB/m) = Antenna Factor(dB/m) + Cable Factor(dB) – Pre-Amplifier Factor(dB)
3. Margin value = Emission Level – Limit value
4. The other emission levels were very low against the limit.
5. " * ": Fundamental frequency.
6. " # ": The radiated frequency is out of the restricted band.

RF Mode	TX 20MHz Preamble 802.11ax (RU106)	Channel	CH 157 : 5785 MHz
Frequency Range	1GHz ~ 40GHz	Detector Function	Peak (PK) Average (AV)

Antenna Polarity & Test Distance : Horizontal at 3 m

No	Frequency (MHz)	Emission Level (dBuV/m)	Limit (dBuV/m)	Margin (dB)	Antenna Height (m)	Table Angle (Degree)	Raw Value (dBuV)	Correction Factor (dB/m)
1	#5585.41	50.4 PK	68.2	-17.8	2.90 H	121	48.3	2.1
2	*5785.00	109.3 PK			2.90 H	121	106.7	2.6
3	*5785.00	98.5 AV			2.90 H	121	95.9	2.6
4	#5966.99	50.7 PK	68.2	-17.5	2.90 H	121	47.8	2.9
5	11570.00	50.3 PK	74.0	-23.7	1.06 H	285	37.7	12.6
6	11570.00	40.1 AV	54.0	-13.9	1.06 H	285	27.5	12.6
7	#17355.00	62.7 PK	68.2	-5.5	3.13 H	301	45.0	17.7

Antenna Polarity & Test Distance : Vertical at 3 m

No	Frequency (MHz)	Emission Level (dBuV/m)	Limit (dBuV/m)	Margin (dB)	Antenna Height (m)	Table Angle (Degree)	Raw Value (dBuV)	Correction Factor (dB/m)
1	#5598.34	52.2 PK	68.2	-16.0	1.49 V	277	50.1	2.1
2	*5785.00	120.6 PK			1.49 V	277	118.0	2.6
3	*5785.00	110.5 AV			1.49 V	277	107.9	2.6
4	#5952.44	52.4 PK	68.2	-15.8	1.49 V	277	49.5	2.9
5	11570.00	53.8 PK	74.0	-20.2	2.06 V	217	41.2	12.6
6	11570.00	43.4 AV	54.0	-10.6	2.06 V	217	30.8	12.6
7	#17355.00	62.9 PK	68.2	-5.3	1.98 V	267	45.2	17.7

Remarks:

1. Emission Level(dBuV/m) = Raw Value(dBuV) + Correction Factor(dB/m)
2. Correction Factor(dB/m) = Antenna Factor(dB/m) + Cable Factor(dB) – Pre-Amplifier Factor(dB)
3. Margin value = Emission Level – Limit value
4. The other emission levels were very low against the limit.
5. " * ": Fundamental frequency.
6. " # ": The radiated frequency is out of the restricted band.

RF Mode	TX 20MHz Preamble 802.11ax (RU106)	Channel	CH 165 : 5825 MHz
Frequency Range	1GHz ~ 40GHz	Detector Function	Peak (PK) Average (AV)

Antenna Polarity & Test Distance : Horizontal at 3 m

No	Frequency (MHz)	Emission Level (dBuV/m)	Limit (dBuV/m)	Margin (dB)	Antenna Height (m)	Table Angle (Degree)	Raw Value (dBuV)	Correction Factor (dB/m)
1	#5581.23	50.7 PK	68.2	-17.5	2.89 H	126	48.6	2.1
2	*5825.00	109.6 PK			2.89 H	126	107.0	2.6
3	*5825.00	98.8 AV			2.89 H	126	96.2	2.6
4	#5956.39	50.5 PK	68.2	-17.7	2.89 H	126	47.6	2.9
5	11650.00	46.5 PK	74.0	-27.5	1.09 H	281	34.3	12.2
6	11650.00	36.8 AV	54.0	-17.2	1.09 H	281	24.6	12.2
7	#17475.00	58.2 PK	68.2	-10.0	3.04 H	298	39.5	18.7

Antenna Polarity & Test Distance : Vertical at 3 m

No	Frequency (MHz)	Emission Level (dBuV/m)	Limit (dBuV/m)	Margin (dB)	Antenna Height (m)	Table Angle (Degree)	Raw Value (dBuV)	Correction Factor (dB/m)
1	#5554.55	51.6 PK	68.2	-16.6	1.42 V	277	49.5	2.1
2	*5825.00	120.5 PK			1.42 V	277	117.9	2.6
3	*5825.00	110.7 AV			1.42 V	277	108.1	2.6
4	#5976.25	52.6 PK	68.2	-15.6	1.42 V	277	49.7	2.9
5	11650.00	49.0 PK	74.0	-25.0	2.08 V	251	36.8	12.2
6	11650.00	39.3 AV	54.0	-14.7	2.08 V	251	27.1	12.2
7	#17475.00	57.1 PK	68.2	-11.1	1.99 V	252	38.4	18.7

Remarks:

1. Emission Level(dBuV/m) = Raw Value(dBuV) + Correction Factor(dB/m)
2. Correction Factor(dB/m) = Antenna Factor(dB/m) + Cable Factor(dB) – Pre-Amplifier Factor(dB)
3. Margin value = Emission Level – Limit value
4. The other emission levels were very low against the limit.
5. " * ": Fundamental frequency.
6. " # ": The radiated frequency is out of the restricted band.

Below 1GHz Data:

RF Mode	TX 802.11a	Channel	CH 157 : 5785 MHz
Frequency Range	9kHz ~ 1GHz	Detector Function	Quasi-Peak (QP)

Antenna Polarity & Test Distance : Horizontal at 3 m								
No	Frequency (MHz)	Emission Level (dBuV/m)	Limit (dBuV/m)	Margin (dB)	Antenna Height (m)	Table Angle (Degree)	Raw Value (dBuV)	Correction Factor (dB/m)
1	119.47	38.1 QP	43.5	-5.4	3.00 H	342	53.2	-15.1
2	166.31	35.1 QP	43.5	-8.4	2.00 H	160	48.2	-13.1
3	227.27	33.9 QP	46.0	-12.1	2.00 H	107	49.7	-15.8
4	298.66	34.4 QP	46.0	-11.6	1.50 H	97	46.8	-12.4
5	336.27	33.5 QP	46.0	-12.5	1.50 H	349	44.8	-11.3
6	575.30	26.9 QP	46.0	-19.1	1.50 H	105	33.1	-6.2

Remarks:

1. Emission Level(dBuV/m) = Raw Value(dBuV) + Correction Factor(dB/m)
2. Correction Factor(dB/m) = Antenna Factor(dB/m) + Cable Factor(dB) – Pre-Amplifier Factor(dB)
3. Margin value = Emission Level – Limit value
4. The other emission levels were very low against the limit of frequency range 30MHz~1000MHz.
5. The emission levels were very low against the limit of frequency range 9kHz~30MHz: the amplitude of spurious emissions attenuated more than 20 dB below the permissible value to be report.

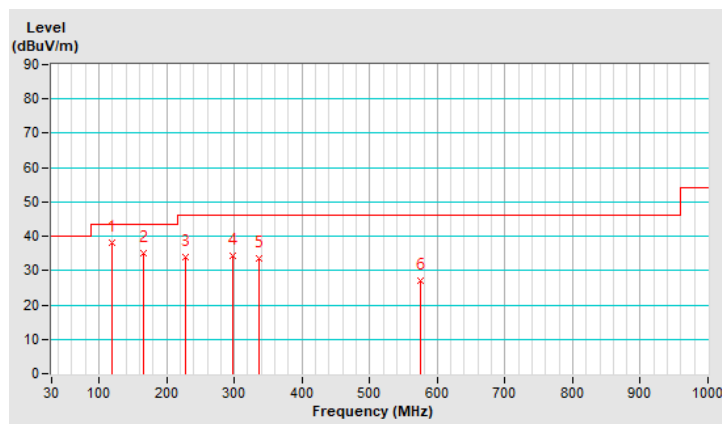

RF Mode	TX 802.11a	Channel	CH 157 : 5785 MHz
Frequency Range	9kHz ~ 1GHz	Detector Function	Quasi-Peak (QP)

Antenna Polarity & Test Distance : Vertical at 3 m

No	Frequency (MHz)	Emission Level (dBuV/m)	Limit (dBuV/m)	Margin (dB)	Antenna Height (m)	Table Angle (Degree)	Raw Value (dBuV)	Correction Factor (dB/m)
1	125.89	29.1 QP	43.5	-14.4	1.00 V	28	43.5	-14.4
2	167.33	32.5 QP	43.5	-11.0	1.50 V	227	45.6	-13.1
3	223.73	30.9 QP	46.0	-15.1	1.00 V	136	46.9	-16.0
4	341.12	26.5 QP	46.0	-19.5	1.50 V	198	37.8	-11.3
5	499.28	24.7 QP	46.0	-21.3	1.50 V	32	32.3	-7.6
6	950.36	32.7 QP	46.0	-13.3	1.00 V	145	33.3	-0.6

Remarks:

1. Emission Level(dBuV/m) = Raw Value(dBuV) + Correction Factor(dB/m)
2. Correction Factor(dB/m) = Antenna Factor(dB/m) + Cable Factor(dB) – Pre-Amplifier Factor(dB)
3. Margin value = Emission Level – Limit value
4. The other emission levels were very low against the limit of frequency range 30MHz~1000MHz.
5. The emission levels were very low against the limit of frequency range 9kHz~30MHz: the amplitude of spurious emissions attenuated more than 20 dB below the permissible value to be report.

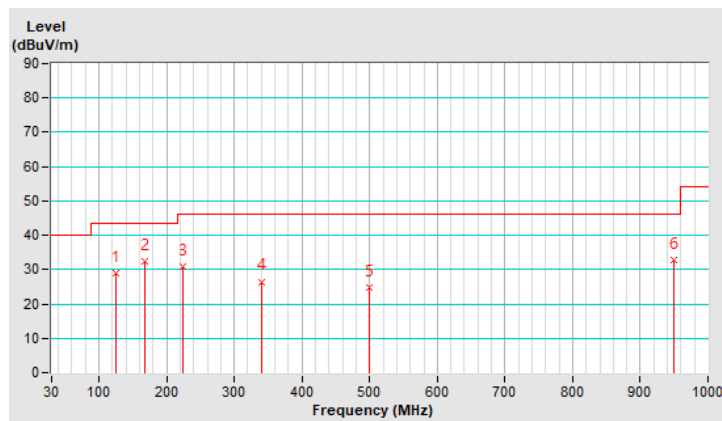

PIFA Antenna

Above 1GHz Data:

RF Mode	TX 802.11a	Channel	CH 36 : 5180 MHz
Frequency Range	1GHz ~ 40GHz	Detector Function	Peak (PK) Average (AV)

Antenna Polarity & Test Distance : Horizontal at 3 m

No	Frequency (MHz)	Emission Level (dBuV/m)	Limit (dBuV/m)	Margin (dB)	Antenna Height (m)	Table Angle (Degree)	Raw Value (dBuV)	Correction Factor (dB/m)
1	5150.00	72.5 PK	74.0	-1.5	1.79 H	141	70.2	2.3
2	5150.00	52.5 AV	54.0	-1.5	1.79 H	141	50.2	2.3
3	*5180.00	115.4 PK			1.79 H	141	113.2	2.2
4	*5180.00	106.3 AV			1.79 H	141	104.1	2.2
5	#10360.00	49.9 PK	68.2	-18.3	3.73 H	303	38.1	11.8
6	15540.00	58.9 PK	74.0	-15.1	1.52 H	273	47.1	11.8
7	15540.00	45.1 AV	54.0	-8.9	1.52 H	273	33.3	11.8

Antenna Polarity & Test Distance : Vertical at 3 m

No	Frequency (MHz)	Emission Level (dBuV/m)	Limit (dBuV/m)	Margin (dB)	Antenna Height (m)	Table Angle (Degree)	Raw Value (dBuV)	Correction Factor (dB/m)
1	5150.00	62.5 PK	74.0	-11.5	1.38 V	141	60.2	2.3
2	5150.00	46.2 AV	54.0	-7.8	1.38 V	141	43.9	2.3
3	*5180.00	107.3 PK			1.38 V	141	105.1	2.2
4	*5180.00	98.5 AV			1.38 V	141	96.3	2.2
5	#10360.00	48.1 PK	68.2	-20.1	2.48 V	317	36.3	11.8
6	15540.00	58.2 PK	74.0	-15.8	1.50 V	281	46.4	11.8
7	15540.00	45.1 AV	54.0	-8.9	1.50 V	281	33.3	11.8

Remarks:

1. Emission Level(dBuV/m) = Raw Value(dBuV) + Correction Factor(dB/m)
2. Correction Factor(dB/m) = Antenna Factor(dB/m) + Cable Factor(dB) – Pre-Amplifier Factor(dB)
3. Margin value = Emission Level – Limit value
4. The other emission levels were very low against the limit.
5. " * ": Fundamental frequency.
6. " # ": The radiated frequency is out of the restricted band.

RF Mode	TX 802.11a	Channel	CH 40 : 5200 MHz
Frequency Range	1GHz ~ 40GHz	Detector Function	Peak (PK) Average (AV)

Antenna Polarity & Test Distance : Horizontal at 3 m

No	Frequency (MHz)	Emission Level (dBuV/m)	Limit (dBuV/m)	Margin (dB)	Antenna Height (m)	Table Angle (Degree)	Raw Value (dBuV)	Correction Factor (dB/m)
1	5150.00	58.9 PK	74.0	-15.1	1.83 H	139	56.6	2.3
2	5150.00	42.2 AV	54.0	-11.8	1.83 H	139	39.9	2.3
3	*5200.00	115.5 PK			1.83 H	139	113.4	2.1
4	*5200.00	106.6 AV			1.83 H	139	104.5	2.1
5	#10400.00	49.1 PK	68.2	-19.1	3.62 H	293	37.1	12.0
6	15600.00	58.6 PK	74.0	-15.4	1.53 H	297	47.1	11.5
7	15600.00	44.6 AV	54.0	-9.4	1.53 H	297	33.1	11.5

Antenna Polarity & Test Distance : Vertical at 3 m

No	Frequency (MHz)	Emission Level (dBuV/m)	Limit (dBuV/m)	Margin (dB)	Antenna Height (m)	Table Angle (Degree)	Raw Value (dBuV)	Correction Factor (dB/m)
1	5150.00	56.9 PK	74.0	-17.1	1.38 V	125	54.6	2.3
2	5150.00	40.8 AV	54.0	-13.2	1.38 V	125	38.5	2.3
3	*5200.00	107.8 PK			1.38 V	125	105.7	2.1
4	*5200.00	99.1 AV			1.38 V	125	97.0	2.1
5	#10400.00	47.7 PK	68.2	-20.5	2.48 V	306	35.7	12.0
6	15600.00	58.1 PK	74.0	-15.9	1.50 V	276	46.6	11.5
7	15600.00	44.7 AV	54.0	-9.3	1.50 V	276	33.2	11.5

Remarks:

1. Emission Level(dBuV/m) = Raw Value(dBuV) + Correction Factor(dB/m)
2. Correction Factor(dB/m) = Antenna Factor(dB/m) + Cable Factor(dB) – Pre-Amplifier Factor(dB)
3. Margin value = Emission Level – Limit value
4. The other emission levels were very low against the limit.
5. " * ": Fundamental frequency.
6. " # ": The radiated frequency is out of the restricted band.

RF Mode	TX 802.11a	Channel	CH 48 : 5240 MHz
Frequency Range	1GHz ~ 40GHz	Detector Function	Peak (PK) Average (AV)

Antenna Polarity & Test Distance : Horizontal at 3 m

No	Frequency (MHz)	Emission Level (dBuV/m)	Limit (dBuV/m)	Margin (dB)	Antenna Height (m)	Table Angle (Degree)	Raw Value (dBuV)	Correction Factor (dB/m)
1	5150.00	52.3 PK	74.0	-21.7	1.81 H	154	50.0	2.3
2	5150.00	39.6 AV	54.0	-14.4	1.81 H	154	37.3	2.3
3	*5240.00	115.6 PK			1.81 H	154	113.6	2.0
4	*5240.00	106.7 AV			1.81 H	154	104.7	2.0
5	5350.00	50.6 PK	74.0	-23.4	1.81 H	154	48.7	1.9
6	5350.00	38.8 AV	54.0	-15.2	1.81 H	154	36.9	1.9
7	#10480.00	49.6 PK	68.2	-18.6	3.69 H	312	37.7	11.9
8	15720.00	59.0 PK	74.0	-15.0	1.48 H	273	47.2	11.8
9	15720.00	45.3 AV	54.0	-8.7	1.48 H	273	33.5	11.8

Antenna Polarity & Test Distance : Vertical at 3 m

No	Frequency (MHz)	Emission Level (dBuV/m)	Limit (dBuV/m)	Margin (dB)	Antenna Height (m)	Table Angle (Degree)	Raw Value (dBuV)	Correction Factor (dB/m)
1	5150.00	51.8 PK	74.0	-22.2	1.40 V	136	49.5	2.3
2	5150.00	38.1 AV	54.0	-15.9	1.40 V	136	35.8	2.3
3	*5240.00	107.3 PK			1.40 V	136	105.3	2.0
4	*5240.00	98.8 AV			1.40 V	136	96.8	2.0
5	5350.00	49.6 PK	74.0	-24.4	1.40 V	136	47.7	1.9
6	5350.00	37.6 AV	54.0	-16.4	1.40 V	136	35.7	1.9
7	#10480.00	47.7 PK	68.2	-20.5	2.45 V	316	35.8	11.9
8	15720.00	58.1 PK	74.0	-15.9	1.41 V	276	46.3	11.8
9	15720.00	44.7 AV	54.0	-9.3	1.41 V	276	32.9	11.8

Remarks:

1. Emission Level(dBuV/m) = Raw Value(dBuV) + Correction Factor(dB/m)
2. Correction Factor(dB/m) = Antenna Factor(dB/m) + Cable Factor(dB) – Pre-Amplifier Factor(dB)
3. Margin value = Emission Level – Limit value
4. The other emission levels were very low against the limit.
5. " * ": Fundamental frequency.
6. " # ": The radiated frequency is out of the restricted band.

RF Mode	TX 802.11a	Channel	CH 52 : 5260 MHz
Frequency Range	1GHz ~ 40GHz	Detector Function	Peak (PK) Average (AV)

Antenna Polarity & Test Distance : Horizontal at 3 m								
No	Frequency (MHz)	Emission Level (dBuV/m)	Limit (dBuV/m)	Margin (dB)	Antenna Height (m)	Table Angle (Degree)	Raw Value (dBuV)	Correction Factor (dB/m)
1	5150.00	51.2 PK	74.0	-22.8	1.78 H	149	48.9	2.3
2	5150.00	39.0 AV	54.0	-15.0	1.78 H	149	36.7	2.3
3	*5260.00	115.3 PK			1.78 H	149	113.3	2.0
4	*5260.00	106.4 AV			1.78 H	149	104.4	2.0
5	5350.00	52.3 PK	74.0	-21.7	1.78 H	149	50.4	1.9
6	5350.00	39.5 AV	54.0	-14.5	1.78 H	149	37.6	1.9
7	#10520.00	49.6 PK	68.2	-18.6	3.63 H	302	37.6	12.0
8	15780.00	58.8 PK	74.0	-15.2	1.52 H	291	47.3	11.5
9	15780.00	45.2 AV	54.0	-8.8	1.52 H	291	33.7	11.5

Antenna Polarity & Test Distance : Vertical at 3 m								
No	Frequency (MHz)	Emission Level (dBuV/m)	Limit (dBuV/m)	Margin (dB)	Antenna Height (m)	Table Angle (Degree)	Raw Value (dBuV)	Correction Factor (dB/m)
1	5150.00	50.9 PK	74.0	-23.1	1.33 V	122	48.6	2.3
2	5150.00	38.6 AV	54.0	-15.4	1.33 V	122	36.3	2.3
3	*5260.00	107.5 PK			1.33 V	122	105.5	2.0
4	*5260.00	98.7 AV			1.33 V	122	96.7	2.0
5	5350.00	51.9 PK	74.0	-22.1	1.33 V	122	50.0	1.9
6	5350.00	38.8 AV	54.0	-15.2	1.33 V	122	36.9	1.9
7	#10520.00	47.9 PK	68.2	-20.3	2.50 V	312	35.9	12.0
8	15780.00	57.3 PK	74.0	-16.7	1.47 V	267	45.8	11.5
9	15780.00	44.3 AV	54.0	-9.7	1.47 V	267	32.8	11.5

Remarks:

1. Emission Level(dBuV/m) = Raw Value(dBuV) + Correction Factor(dB/m)
2. Correction Factor(dB/m) = Antenna Factor(dB/m) + Cable Factor(dB) – Pre-Amplifier Factor(dB)
3. Margin value = Emission Level – Limit value
4. The other emission levels were very low against the limit.
5. " * ": Fundamental frequency.
6. " # ": The radiated frequency is out of the restricted band.

RF Mode	TX 802.11a	Channel	CH 60 : 5300 MHz
Frequency Range	1GHz ~ 40GHz	Detector Function	Peak (PK) Average (AV)

Antenna Polarity & Test Distance : Horizontal at 3 m

No	Frequency (MHz)	Emission Level (dBuV/m)	Limit (dBuV/m)	Margin (dB)	Antenna Height (m)	Table Angle (Degree)	Raw Value (dBuV)	Correction Factor (dB/m)
1	*5300.00	115.2 PK			1.75 H	152	113.5	1.7
2	*5300.00	106.3 AV			1.75 H	152	104.6	1.7
3	5350.00	63.8 PK	74.0	-10.2	1.75 H	152	61.9	1.9
4	5350.00	43.9 AV	54.0	-10.1	1.75 H	152	42.0	1.9
5	10600.00	49.9 PK	74.0	-24.1	3.62 H	313	38.0	11.9
6	10600.00	37.8 AV	54.0	-16.2	3.62 H	313	25.9	11.9
7	15900.00	58.3 PK	74.0	-15.7	1.46 H	278	47.0	11.3
8	15900.00	44.6 AV	54.0	-9.4	1.46 H	278	33.3	11.3

Antenna Polarity & Test Distance : Vertical at 3 m

No	Frequency (MHz)	Emission Level (dBuV/m)	Limit (dBuV/m)	Margin (dB)	Antenna Height (m)	Table Angle (Degree)	Raw Value (dBuV)	Correction Factor (dB/m)
1	*5300.00	106.9 PK			1.37 V	116	105.2	1.7
2	*5300.00	98.4 AV			1.37 V	116	96.7	1.7
3	5350.00	61.9 PK	74.0	-12.1	1.37 V	116	60.0	1.9
4	5350.00	42.1 AV	54.0	-11.9	1.37 V	116	40.2	1.9
5	10600.00	47.8 PK	74.0	-26.2	2.50 V	333	35.9	11.9
6	10600.00	36.0 AV	54.0	-18.0	2.50 V	333	24.1	11.9
7	15900.00	58.0 PK	74.0	-16.0	1.45 V	285	46.7	11.3
8	15900.00	44.5 AV	54.0	-9.5	1.45 V	285	33.2	11.3

Remarks:

1. Emission Level(dBuV/m) = Raw Value(dBuV) + Correction Factor(dB/m)
2. Correction Factor(dB/m) = Antenna Factor(dB/m) + Cable Factor(dB) – Pre-Amplifier Factor(dB)
3. Margin value = Emission Level – Limit value
4. The other emission levels were very low against the limit.
5. " * ": Fundamental frequency.

RF Mode	TX 802.11a	Channel	CH 64 : 5320 MHz
Frequency Range	1GHz ~ 40GHz	Detector Function	Peak (PK) Average (AV)

Antenna Polarity & Test Distance : Horizontal at 3 m

No	Frequency (MHz)	Emission Level (dBuV/m)	Limit (dBuV/m)	Margin (dB)	Antenna Height (m)	Table Angle (Degree)	Raw Value (dBuV)	Correction Factor (dB/m)
1	*5320.00	114.1 PK			1.80 H	142	112.3	1.8
2	*5320.00	105.1 AV			1.80 H	142	103.3	1.8
3	5350.00	71.7 PK	74.0	-2.3	1.80 H	142	69.8	1.9
4	5350.00	52.3 AV	54.0	-1.7	1.80 H	142	50.4	1.9
5	10640.00	49.6 PK	74.0	-24.4	3.72 H	306	37.8	11.8
6	10640.00	37.4 AV	54.0	-16.6	3.72 H	306	25.6	11.8
7	15960.00	58.4 PK	74.0	-15.6	1.53 H	280	46.8	11.6
8	15960.00	44.7 AV	54.0	-9.3	1.53 H	280	33.1	11.6

Antenna Polarity & Test Distance : Vertical at 3 m

No	Frequency (MHz)	Emission Level (dBuV/m)	Limit (dBuV/m)	Margin (dB)	Antenna Height (m)	Table Angle (Degree)	Raw Value (dBuV)	Correction Factor (dB/m)
1	*5320.00	106.5 PK			1.56 V	141	104.7	1.8
2	*5320.00	97.4 AV			1.56 V	141	95.6	1.8
3	5350.00	61.7 PK	74.0	-12.3	1.56 V	141	59.8	1.9
4	5350.00	44.7 AV	54.0	-9.3	1.56 V	141	42.8	1.9
5	10640.00	48.1 PK	74.0	-25.9	2.52 V	330	36.3	11.8
6	10640.00	36.2 AV	54.0	-17.8	2.52 V	330	24.4	11.8
7	15960.00	58.1 PK	74.0	-15.9	1.42 V	289	46.5	11.6
8	15960.00	44.8 AV	54.0	-9.2	1.42 V	289	33.2	11.6

Remarks:

1. Emission Level(dBuV/m) = Raw Value(dBuV) + Correction Factor(dB/m)
2. Correction Factor(dB/m) = Antenna Factor(dB/m) + Cable Factor(dB) – Pre-Amplifier Factor(dB)
3. Margin value = Emission Level – Limit value
4. The other emission levels were very low against the limit.
5. " * ": Fundamental frequency.

RF Mode	TX 802.11a	Channel	CH 100 : 5500 MHz
Frequency Range	1GHz ~ 40GHz	Detector Function	Peak (PK) Average (AV)

Antenna Polarity & Test Distance : Horizontal at 3 m

No	Frequency (MHz)	Emission Level (dBuV/m)	Limit (dBuV/m)	Margin (dB)	Antenna Height (m)	Table Angle (Degree)	Raw Value (dBuV)	Correction Factor (dB/m)
1	5455.20	59.0 PK	74.0	-15.0	2.13 H	130	56.9	2.1
2	5455.20	43.0 AV	54.0	-11.0	2.13 H	130	40.9	2.1
3	5460.00	58.5 PK	74.0	-15.5	2.13 H	130	56.4	2.1
4	5460.00	44.2 AV	54.0	-9.8	2.13 H	130	42.1	2.1
5	#5468.80	66.6 PK	68.2	-1.6	1.00 H	0	64.4	2.2
6	*5500.00	114.4 PK			2.13 H	130	112.3	2.1
7	*5500.00	105.3 AV			2.13 H	130	103.2	2.1
8	11000.00	49.6 PK	74.0	-24.4	3.67 H	307	37.2	12.4
9	11000.00	37.9 AV	54.0	-16.1	3.67 H	307	25.5	12.4
10	#16500.00	58.4 PK	68.2	-9.8	1.56 H	290	44.7	13.7

Antenna Polarity & Test Distance : Vertical at 3 m

No	Frequency (MHz)	Emission Level (dBuV/m)	Limit (dBuV/m)	Margin (dB)	Antenna Height (m)	Table Angle (Degree)	Raw Value (dBuV)	Correction Factor (dB/m)
1	5460.00	51.2 PK	74.0	-22.8	1.54 V	150	49.1	2.1
2	5460.00	39.2 AV	54.0	-14.8	1.54 V	150	37.1	2.1
3	#5466.40	58.3 PK	68.2	-9.9	1.54 V	150	56.2	2.1
4	*5500.00	105.7 PK			1.54 V	150	103.6	2.1
5	*5500.00	96.8 AV			1.54 V	150	94.7	2.1
6	11000.00	48.5 PK	74.0	-25.5	2.49 V	337	36.1	12.4
7	11000.00	36.4 AV	54.0	-17.6	2.49 V	337	24.0	12.4
8	#16500.00	58.1 PK	68.2	-10.1	1.40 V	282	44.4	13.7

Remarks:

1. Emission Level(dBuV/m) = Raw Value(dBuV) + Correction Factor(dB/m)
2. Correction Factor(dB/m) = Antenna Factor(dB/m) + Cable Factor(dB) – Pre-Amplifier Factor(dB)
3. Margin value = Emission Level – Limit value
4. The other emission levels were very low against the limit.
5. " * ": Fundamental frequency.
6. " # ": The radiated frequency is out of the restricted band.

RF Mode	TX 802.11a	Channel	CH 116 : 5580 MHz
Frequency Range	1GHz ~ 40GHz	Detector Function	Peak (PK) Average (AV)

Antenna Polarity & Test Distance : Horizontal at 3 m								
No	Frequency (MHz)	Emission Level (dBuV/m)	Limit (dBuV/m)	Margin (dB)	Antenna Height (m)	Table Angle (Degree)	Raw Value (dBuV)	Correction Factor (dB/m)
1	5460.00	50.2 PK	74.0	-23.8	2.07 H	135	48.1	2.1
2	5460.00	38.1 AV	54.0	-15.9	2.07 H	135	36.0	2.1
3	#5470.00	53.4 PK	68.2	-14.8	2.07 H	135	51.2	2.2
4	*5580.00	115.9 PK			2.07 H	135	113.8	2.1
5	*5580.00	106.8 AV			2.07 H	135	104.7	2.1
6	11160.00	49.9 PK	74.0	-24.1	3.69 H	309	37.9	12.0
7	11160.00	37.9 AV	54.0	-16.1	3.69 H	309	25.9	12.0
8	#16740.00	58.5 PK	68.2	-9.7	1.56 H	287	43.2	15.3
Antenna Polarity & Test Distance : Vertical at 3 m								
No	Frequency (MHz)	Emission Level (dBuV/m)	Limit (dBuV/m)	Margin (dB)	Antenna Height (m)	Table Angle (Degree)	Raw Value (dBuV)	Correction Factor (dB/m)
1	5460.00	49.8 PK	74.0	-24.2	1.40 V	113	47.7	2.1
2	5460.00	37.8 AV	54.0	-16.2	1.40 V	113	35.7	2.1
3	#5470.00	52.8 PK	68.2	-15.4	1.40 V	113	50.6	2.2
4	*5580.00	106.3 PK			1.40 V	113	104.2	2.1
5	*5580.00	98.0 AV			1.40 V	113	95.9	2.1
6	11160.00	48.6 PK	74.0	-25.4	2.49 V	342	36.6	12.0
7	11160.00	36.2 AV	54.0	-17.8	2.49 V	342	24.2	12.0
8	#16740.00	57.9 PK	68.2	-10.3	1.44 V	297	42.6	15.3

Remarks:

1. Emission Level(dBuV/m) = Raw Value(dBuV) + Correction Factor(dB/m)
2. Correction Factor(dB/m) = Antenna Factor(dB/m) + Cable Factor(dB) – Pre-Amplifier Factor(dB)
3. Margin value = Emission Level – Limit value
4. The other emission levels were very low against the limit.
5. " * ": Fundamental frequency.
6. " # ": The radiated frequency is out of the restricted band.

RF Mode	TX 802.11a	Channel	CH 140 : 5700 MHz
Frequency Range	1GHz ~ 40GHz	Detector Function	Peak (PK) Average (AV)

Antenna Polarity & Test Distance : Horizontal at 3 m

No	Frequency (MHz)	Emission Level (dBuV/m)	Limit (dBuV/m)	Margin (dB)	Antenna Height (m)	Table Angle (Degree)	Raw Value (dBuV)	Correction Factor (dB/m)
1	*5700.00	112.4 PK			2.03 H	125	110.1	2.3
2	*5700.00	103.5 AV			2.03 H	125	101.2	2.3
3	#5725.00	66.7 PK	68.2	-1.5	2.03 H	125	64.3	2.4
4	11400.00	49.2 PK	74.0	-24.8	3.63 H	291	36.7	12.5
5	11400.00	37.0 AV	54.0	-17.0	3.63 H	291	24.5	12.5
6	#17100.00	58.5 PK	68.2	-9.7	1.49 H	282	41.7	16.8

Antenna Polarity & Test Distance : Vertical at 3 m

No	Frequency (MHz)	Emission Level (dBuV/m)	Limit (dBuV/m)	Margin (dB)	Antenna Height (m)	Table Angle (Degree)	Raw Value (dBuV)	Correction Factor (dB/m)
1	*5700.00	102.8 PK			1.41 V	119	100.5	2.3
2	*5700.00	95.3 AV			1.41 V	119	93.0	2.3
3	#5725.00	56.4 PK	68.2	-11.8	1.41 V	119	54.0	2.4
4	11400.00	49.0 PK	74.0	-25.0	2.51 V	338	36.5	12.5
5	11400.00	36.8 AV	54.0	-17.2	2.51 V	338	24.3	12.5
6	#17100.00	58.4 PK	68.2	-9.8	1.43 V	277	41.6	16.8

Remarks:

1. Emission Level(dBuV/m) = Raw Value(dBuV) + Correction Factor(dB/m)
2. Correction Factor(dB/m) = Antenna Factor(dB/m) + Cable Factor(dB) – Pre-Amplifier Factor(dB)
3. Margin value = Emission Level – Limit value
4. The other emission levels were very low against the limit.
5. " * ": Fundamental frequency.
6. " # ": The radiated frequency is out of the restricted band.

RF Mode	TX 802.11a	Channel	CH 144 : 5720 MHz
Frequency Range	1GHz ~ 40GHz	Detector Function	Peak (PK) Average (AV)

Antenna Polarity & Test Distance : Horizontal at 3 m

No	Frequency (MHz)	Emission Level (dBuV/m)	Limit (dBuV/m)	Margin (dB)	Antenna Height (m)	Table Angle (Degree)	Raw Value (dBuV)	Correction Factor (dB/m)
1	5460.00	50.5 PK	74.0	-23.5	2.01 H	127	48.4	2.1
2	5460.00	38.3 AV	54.0	-15.7	2.01 H	127	36.2	2.1
3	#5470.00	51.5 PK	68.2	-16.7	2.01 H	127	49.3	2.2
4	*5720.00	114.5 PK			2.01 H	127	112.1	2.4
5	*5720.00	105.5 AV			2.01 H	127	103.1	2.4
6	#5850.00	51.0 PK	68.2	-17.2	1.00 H	0	48.3	2.7
7	11440.00	49.8 PK	74.0	-24.2	3.73 H	292	37.4	12.4
8	11440.00	37.5 AV	54.0	-16.5	3.73 H	292	25.1	12.4
9	#17160.00	58.8 PK	68.2	-9.4	1.58 H	276	42.2	16.6

Antenna Polarity & Test Distance : Vertical at 3 m

No	Frequency (MHz)	Emission Level (dBuV/m)	Limit (dBuV/m)	Margin (dB)	Antenna Height (m)	Table Angle (Degree)	Raw Value (dBuV)	Correction Factor (dB/m)
1	5460.00	49.8 PK	74.0	-24.2	1.44 V	124	47.7	2.1
2	5460.00	37.8 AV	54.0	-16.2	1.44 V	124	35.7	2.1
3	#5470.00	51.0 PK	68.2	-17.2	1.44 V	124	48.8	2.2
4	*5720.00	106.8 PK			1.44 V	124	104.4	2.4
5	*5720.00	97.8 AV			1.44 V	124	95.4	2.4
6	#5850.00	50.8 PK	68.2	-17.4	1.44 V	124	48.1	2.7
7	11440.00	48.2 PK	74.0	-25.8	2.55 V	342	35.8	12.4
8	11440.00	35.9 AV	54.0	-18.1	2.55 V	342	23.5	12.4
9	#17160.00	58.5 PK	68.2	-9.7	1.44 V	277	41.9	16.6

Remarks:

1. Emission Level(dBuV/m) = Raw Value(dBuV) + Correction Factor(dB/m)
2. Correction Factor(dB/m) = Antenna Factor(dB/m) + Cable Factor(dB) – Pre-Amplifier Factor(dB)
3. Margin value = Emission Level – Limit value
4. The other emission levels were very low against the limit.
5. " * ": Fundamental frequency.
6. " # ": The radiated frequency is out of the restricted band.

RF Mode	TX 802.11a	Channel	CH 149 : 5745 MHz
Frequency Range	1GHz ~ 40GHz	Detector Function	Peak (PK) Average (AV)

Antenna Polarity & Test Distance : Horizontal at 3 m

No	Frequency (MHz)	Emission Level (dBuV/m)	Limit (dBuV/m)	Margin (dB)	Antenna Height (m)	Table Angle (Degree)	Raw Value (dBuV)	Correction Factor (dB/m)
1	#5647.70	56.1 PK	68.2	-12.1	1.91 H	133	53.8	2.3
2	*5745.00	115.9 PK			1.91 H	133	113.5	2.4
3	*5745.00	106.7 AV			1.91 H	133	104.3	2.4
4	#5954.94	51.6 PK	68.2	-16.6	1.91 H	133	48.7	2.9
5	11490.00	49.4 PK	74.0	-24.6	3.67 H	284	36.8	12.6
6	11490.00	37.3 AV	54.0	-16.7	3.67 H	284	24.7	12.6
7	#17235.00	58.7 PK	68.2	-9.5	1.53 H	267	41.9	16.8

Antenna Polarity & Test Distance : Vertical at 3 m

No	Frequency (MHz)	Emission Level (dBuV/m)	Limit (dBuV/m)	Margin (dB)	Antenna Height (m)	Table Angle (Degree)	Raw Value (dBuV)	Correction Factor (dB/m)
1	#5637.58	50.0 PK	68.2	-18.2	1.55 V	166	47.7	2.3
2	*5745.00	108.5 PK			1.55 V	166	106.1	2.4
3	*5745.00	99.2 AV			1.55 V	166	96.8	2.4
4	#6022.49	51.1 PK	68.2	-17.1	1.55 V	166	48.1	3.0
5	11490.00	48.5 PK	74.0	-25.5	2.51 V	331	35.9	12.6
6	11490.00	36.3 AV	54.0	-17.7	2.51 V	331	23.7	12.6
7	#17235.00	58.1 PK	68.2	-10.1	1.37 V	285	41.3	16.8

Remarks:

1. Emission Level(dBuV/m) = Raw Value(dBuV) + Correction Factor(dB/m)
2. Correction Factor(dB/m) = Antenna Factor(dB/m) + Cable Factor(dB) – Pre-Amplifier Factor(dB)
3. Margin value = Emission Level – Limit value
4. The other emission levels were very low against the limit.
5. " * ": Fundamental frequency.
6. " # ": The radiated frequency is out of the restricted band.

RF Mode	TX 802.11a	Channel	CH 157 : 5785 MHz
Frequency Range	1GHz ~ 40GHz	Detector Function	Peak (PK) Average (AV)

Antenna Polarity & Test Distance : Horizontal at 3 m								
No	Frequency (MHz)	Emission Level (dBuV/m)	Limit (dBuV/m)	Margin (dB)	Antenna Height (m)	Table Angle (Degree)	Raw Value (dBuV)	Correction Factor (dB/m)
1	#5642.84	52.9 PK	68.2	-15.3	1.95 H	135	50.6	2.3
2	*5785.00	116.2 PK			1.95 H	135	113.6	2.6
3	*5785.00	107.0 AV			1.95 H	135	104.4	2.6
4	#5995.05	51.2 PK	68.2	-17.0	1.95 H	135	48.3	2.9
5	11570.00	49.4 PK	74.0	-24.6	3.67 H	297	36.8	12.6
6	11570.00	37.4 AV	54.0	-16.6	3.67 H	297	24.8	12.6
7	#17355.00	58.6 PK	68.2	-9.6	1.52 H	282	40.9	17.7

Antenna Polarity & Test Distance : Vertical at 3 m								
No	Frequency (MHz)	Emission Level (dBuV/m)	Limit (dBuV/m)	Margin (dB)	Antenna Height (m)	Table Angle (Degree)	Raw Value (dBuV)	Correction Factor (dB/m)
1	#5609.97	50.4 PK	68.2	-17.8	1.49 V	151	48.3	2.1
2	*5785.00	108.8 PK			1.49 V	151	106.2	2.6
3	*5785.00	99.5 AV			1.49 V	151	96.9	2.6
4	#5942.90	51.1 PK	68.2	-17.1	1.49 V	151	48.2	2.9
5	11570.00	48.3 PK	74.0	-25.7	2.46 V	319	35.7	12.6
6	11570.00	36.4 AV	54.0	-17.6	2.46 V	319	23.8	12.6
7	#17355.00	57.9 PK	68.2	-10.3	1.45 V	277	40.2	17.7

Remarks:

1. Emission Level(dBuV/m) = Raw Value(dBuV) + Correction Factor(dB/m)
2. Correction Factor(dB/m) = Antenna Factor(dB/m) + Cable Factor(dB) – Pre-Amplifier Factor(dB)
3. Margin value = Emission Level – Limit value
4. The other emission levels were very low against the limit.
5. " * ": Fundamental frequency.
6. " # ": The radiated frequency is out of the restricted band.

RF Mode	TX 802.11a	Channel	CH 165 : 5825 MHz
Frequency Range	1GHz ~ 40GHz	Detector Function	Peak (PK) Average (AV)

Antenna Polarity & Test Distance : Horizontal at 3 m

No	Frequency (MHz)	Emission Level (dBuV/m)	Limit (dBuV/m)	Margin (dB)	Antenna Height (m)	Table Angle (Degree)	Raw Value (dBuV)	Correction Factor (dB/m)
1	#5566.47	51.6 PK	68.2	-16.6	1.90 H	139	49.5	2.1
2	*5825.00	115.6 PK			1.90 H	139	113.0	2.6
3	*5825.00	106.5 AV			1.90 H	139	103.9	2.6
4	#5925.96	52.2 PK	68.2	-16.0	1.90 H	139	49.3	2.9
5	11650.00	49.4 PK	74.0	-24.6	3.70 H	291	37.2	12.2
6	11650.00	37.5 AV	54.0	-16.5	3.70 H	291	25.3	12.2
7	#17475.00	58.4 PK	68.2	-9.8	1.47 H	291	39.7	18.7

Antenna Polarity & Test Distance : Vertical at 3 m

No	Frequency (MHz)	Emission Level (dBuV/m)	Limit (dBuV/m)	Margin (dB)	Antenna Height (m)	Table Angle (Degree)	Raw Value (dBuV)	Correction Factor (dB/m)
1	#5602.23	49.9 PK	68.2	-18.3	1.49 V	148	47.8	2.1
2	*5825.00	108.2 PK			1.49 V	148	105.6	2.6
3	*5825.00	99.0 AV			1.49 V	148	96.4	2.6
4	#5925.87	50.8 PK	68.2	-17.4	1.49 V	148	47.9	2.9
5	11650.00	48.4 PK	74.0	-25.6	2.49 V	334	36.2	12.2
6	11650.00	36.4 AV	54.0	-17.6	2.49 V	334	24.2	12.2
7	#17475.00	57.4 PK	68.2	-10.8	1.46 V	282	38.7	18.7

Remarks:

1. Emission Level(dBuV/m) = Raw Value(dBuV) + Correction Factor(dB/m)
2. Correction Factor(dB/m) = Antenna Factor(dB/m) + Cable Factor(dB) – Pre-Amplifier Factor(dB)
3. Margin value = Emission Level – Limit value
4. The other emission levels were very low against the limit.
5. " * ": Fundamental frequency.
6. " # ": The radiated frequency is out of the restricted band.

RF Mode	TX 802.11ax (HE20)	Channel	CH 36 : 5180 MHz
Frequency Range	1GHz ~ 40GHz	Detector Function	Peak (PK) Average (AV)

Antenna Polarity & Test Distance : Horizontal at 3 m								
No	Frequency (MHz)	Emission Level (dBuV/m)	Limit (dBuV/m)	Margin (dB)	Antenna Height (m)	Table Angle (Degree)	Raw Value (dBuV)	Correction Factor (dB/m)
1	5150.00	66.2 PK	74.0	-7.8	1.78 H	139	63.9	2.3
2	5150.00	52.5 AV	54.0	-1.5	1.78 H	139	50.2	2.3
3	*5180.00	116.9 PK			1.78 H	139	114.7	2.2
4	*5180.00	105.7 AV			1.78 H	139	103.5	2.2
5	#10360.00	49.9 PK	68.2	-18.3	3.68 H	300	38.1	11.8
6	15540.00	59.2 PK	74.0	-14.8	1.56 H	271	47.4	11.8
7	15540.00	45.4 AV	54.0	-8.6	1.56 H	271	33.6	11.8
Antenna Polarity & Test Distance : Vertical at 3 m								
No	Frequency (MHz)	Emission Level (dBuV/m)	Limit (dBuV/m)	Margin (dB)	Antenna Height (m)	Table Angle (Degree)	Raw Value (dBuV)	Correction Factor (dB/m)
1	5150.00	58.5 PK	74.0	-15.5	1.50 V	141	56.2	2.3
2	5150.00	45.3 AV	54.0	-8.7	1.50 V	141	43.0	2.3
3	*5180.00	109.6 PK			1.50 V	141	107.4	2.2
4	*5180.00	98.4 AV			1.50 V	141	96.2	2.2
5	#10360.00	48.9 PK	68.2	-19.3	2.44 V	336	37.1	11.8
6	15540.00	58.7 PK	74.0	-15.3	1.35 V	275	46.9	11.8
7	15540.00	45.1 AV	54.0	-8.9	1.35 V	275	33.3	11.8

Remarks:

1. Emission Level(dBuV/m) = Raw Value(dBuV) + Correction Factor(dB/m)
2. Correction Factor(dB/m) = Antenna Factor(dB/m) + Cable Factor(dB) – Pre-Amplifier Factor(dB)
3. Margin value = Emission Level – Limit value
4. The other emission levels were very low against the limit.
5. " * ": Fundamental frequency.
6. " # ": The radiated frequency is out of the restricted band.

RF Mode	TX 802.11ax (HE20)	Channel	CH 40 : 5200 MHz
Frequency Range	1GHz ~ 40GHz	Detector Function	Peak (PK) Average (AV)

Antenna Polarity & Test Distance : Horizontal at 3 m

No	Frequency (MHz)	Emission Level (dBuV/m)	Limit (dBuV/m)	Margin (dB)	Antenna Height (m)	Table Angle (Degree)	Raw Value (dBuV)	Correction Factor (dB/m)
1	5150.00	58.8 PK	74.0	-15.2	1.75 H	152	56.5	2.3
2	5150.00	42.3 AV	54.0	-11.7	1.75 H	152	40.0	2.3
3	*5200.00	117.7 PK			1.75 H	152	115.6	2.1
4	*5200.00	106.6 AV			1.75 H	152	104.5	2.1
5	#10400.00	49.5 PK	68.2	-18.7	3.64 H	301	37.5	12.0
6	15600.00	58.4 PK	74.0	-15.6	1.57 H	296	46.9	11.5
7	15600.00	44.9 AV	54.0	-9.1	1.57 H	296	33.4	11.5

Antenna Polarity & Test Distance : Vertical at 3 m

No	Frequency (MHz)	Emission Level (dBuV/m)	Limit (dBuV/m)	Margin (dB)	Antenna Height (m)	Table Angle (Degree)	Raw Value (dBuV)	Correction Factor (dB/m)
1	5150.00	57.6 PK	74.0	-16.4	1.42 V	138	55.3	2.3
2	5150.00	41.6 AV	54.0	-12.4	1.42 V	138	39.3	2.3
3	*5200.00	110.8 PK			1.42 V	138	108.7	2.1
4	*5200.00	99.8 AV			1.42 V	138	97.7	2.1
5	#10400.00	48.6 PK	68.2	-19.6	2.54 V	353	36.6	12.0
6	15600.00	58.7 PK	74.0	-15.3	1.36 V	269	47.2	11.5
7	15600.00	44.9 AV	54.0	-9.1	1.36 V	269	33.4	11.5

Remarks:

1. Emission Level(dBuV/m) = Raw Value(dBuV) + Correction Factor(dB/m)
2. Correction Factor(dB/m) = Antenna Factor(dB/m) + Cable Factor(dB) – Pre-Amplifier Factor(dB)
3. Margin value = Emission Level – Limit value
4. The other emission levels were very low against the limit.
5. " * ": Fundamental frequency.
6. " # ": The radiated frequency is out of the restricted band.

RF Mode	TX 802.11ax (HE20)	Channel	CH 48 : 5240 MHz
Frequency Range	1GHz ~ 40GHz	Detector Function	Peak (PK) Average (AV)

Antenna Polarity & Test Distance : Horizontal at 3 m

No	Frequency (MHz)	Emission Level (dBuV/m)	Limit (dBuV/m)	Margin (dB)	Antenna Height (m)	Table Angle (Degree)	Raw Value (dBuV)	Correction Factor (dB/m)
1	5150.00	51.9 PK	74.0	-22.1	1.60 H	146	49.6	2.3
2	5150.00	39.4 AV	54.0	-14.6	1.60 H	146	37.1	2.3
3	*5240.00	117.5 PK			1.60 H	146	115.5	2.0
4	*5240.00	106.4 AV			1.60 H	146	104.4	2.0
5	5350.00	50.6 PK	74.0	-23.4	1.60 H	146	48.7	1.9
6	5350.00	39.1 AV	54.0	-14.9	1.60 H	146	37.2	1.9
7	#10480.00	49.6 PK	68.2	-18.6	3.65 H	287	37.7	11.9
8	15720.00	58.3 PK	74.0	-15.7	1.56 H	268	46.5	11.8
9	15720.00	44.7 AV	54.0	-9.3	1.56 H	268	32.9	11.8

Antenna Polarity & Test Distance : Vertical at 3 m

No	Frequency (MHz)	Emission Level (dBuV/m)	Limit (dBuV/m)	Margin (dB)	Antenna Height (m)	Table Angle (Degree)	Raw Value (dBuV)	Correction Factor (dB/m)
1	5150.00	50.6 PK	74.0	-23.4	1.43 V	129	48.3	2.3
2	5150.00	38.2 AV	54.0	-15.8	1.43 V	129	35.9	2.3
3	*5240.00	110.2 PK			1.43 V	129	108.2	2.0
4	*5240.00	99.4 AV			1.43 V	129	97.4	2.0
5	5350.00	49.9 PK	74.0	-24.1	1.43 V	129	48.0	1.9
6	5350.00	38.8 AV	54.0	-15.2	1.43 V	129	36.9	1.9
7	#10480.00	49.0 PK	68.2	-19.2	2.43 V	336	37.1	11.9
8	15720.00	57.8 PK	74.0	-16.2	1.45 V	271	46.0	11.8
9	15720.00	44.6 AV	54.0	-9.4	1.45 V	271	32.8	11.8

Remarks:

1. Emission Level(dBuV/m) = Raw Value(dBuV) + Correction Factor(dB/m)
2. Correction Factor(dB/m) = Antenna Factor(dB/m) + Cable Factor(dB) – Pre-Amplifier Factor(dB)
3. Margin value = Emission Level – Limit value
4. The other emission levels were very low against the limit.
5. " * ": Fundamental frequency.
6. " # ": The radiated frequency is out of the restricted band.

RF Mode	TX 802.11ax (HE20)	Channel	CH 52 : 5260 MHz
Frequency Range	1GHz ~ 40GHz	Detector Function	Peak (PK) Average (AV)

Antenna Polarity & Test Distance : Horizontal at 3 m

No	Frequency (MHz)	Emission Level (dBuV/m)	Limit (dBuV/m)	Margin (dB)	Antenna Height (m)	Table Angle (Degree)	Raw Value (dBuV)	Correction Factor (dB/m)
1	5150.00	51.7 PK	74.0	-22.3	1.73 H	148	49.4	2.3
2	5150.00	39.0 AV	54.0	-15.0	1.73 H	148	36.7	2.3
3	*5260.00	117.6 PK			1.73 H	148	115.6	2.0
4	*5260.00	106.6 AV			1.73 H	148	104.6	2.0
5	5350.00	52.1 PK	74.0	-21.9	1.73 H	148	50.2	1.9
6	5350.00	39.5 AV	54.0	-14.5	1.73 H	148	37.6	1.9
7	#10520.00	49.1 PK	68.2	-19.1	3.65 H	283	37.1	12.0
8	15780.00	58.6 PK	74.0	-15.4	1.49 H	296	47.1	11.5
9	15780.00	44.8 AV	54.0	-9.2	1.49 H	296	33.3	11.5

Antenna Polarity & Test Distance : Vertical at 3 m

No	Frequency (MHz)	Emission Level (dBuV/m)	Limit (dBuV/m)	Margin (dB)	Antenna Height (m)	Table Angle (Degree)	Raw Value (dBuV)	Correction Factor (dB/m)
1	5150.00	50.6 PK	74.0	-23.4	1.32 V	113	48.3	2.3
2	5150.00	38.5 AV	54.0	-15.5	1.32 V	113	36.2	2.3
3	*5260.00	109.8 PK			1.32 V	113	107.8	2.0
4	*5260.00	99.2 AV			1.32 V	113	97.2	2.0
5	5350.00	51.6 PK	74.0	-22.4	1.32 V	113	49.7	1.9
6	5350.00	39.0 AV	54.0	-15.0	1.32 V	113	37.1	1.9
7	#10520.00	48.8 PK	68.2	-19.4	2.53 V	333	36.8	12.0
8	15780.00	58.0 PK	74.0	-16.0	1.38 V	285	46.5	11.5
9	15780.00	44.4 AV	54.0	-9.6	1.38 V	285	32.9	11.5

Remarks:

1. Emission Level(dBuV/m) = Raw Value(dBuV) + Correction Factor(dB/m)
2. Correction Factor(dB/m) = Antenna Factor(dB/m) + Cable Factor(dB) – Pre-Amplifier Factor(dB)
3. Margin value = Emission Level – Limit value
4. The other emission levels were very low against the limit.
5. " * ": Fundamental frequency.
6. " # ": The radiated frequency is out of the restricted band.

RF Mode	TX 802.11ax (HE20)	Channel	CH 60 : 5300 MHz
Frequency Range	1GHz ~ 40GHz	Detector Function	Peak (PK) Average (AV)

Antenna Polarity & Test Distance : Horizontal at 3 m

No	Frequency (MHz)	Emission Level (dBuV/m)	Limit (dBuV/m)	Margin (dB)	Antenna Height (m)	Table Angle (Degree)	Raw Value (dBuV)	Correction Factor (dB/m)
1	*5300.00	117.3 PK			1.83 H	142	115.6	1.7
2	*5300.00	106.3 AV			1.83 H	142	104.6	1.7
3	5350.00	63.8 PK	74.0	-10.2	1.83 H	142	61.9	1.9
4	5350.00	44.2 AV	54.0	-9.8	1.83 H	142	42.3	1.9
5	10600.00	49.4 PK	74.0	-24.6	3.62 H	305	37.5	11.9
6	10600.00	37.2 AV	54.0	-16.8	3.62 H	305	25.3	11.9
7	15900.00	58.4 PK	74.0	-15.6	1.54 H	280	47.1	11.3
8	15900.00	44.5 AV	54.0	-9.5	1.54 H	280	33.2	11.3

Antenna Polarity & Test Distance : Vertical at 3 m

No	Frequency (MHz)	Emission Level (dBuV/m)	Limit (dBuV/m)	Margin (dB)	Antenna Height (m)	Table Angle (Degree)	Raw Value (dBuV)	Correction Factor (dB/m)
1	*5300.00	110.0 PK			1.33 V	127	108.3	1.7
2	*5300.00	99.3 AV			1.33 V	127	97.6	1.7
3	5350.00	61.9 PK	74.0	-12.1	1.33 V	127	60.0	1.9
4	5350.00	42.8 AV	54.0	-11.2	1.33 V	127	40.9	1.9
5	10600.00	48.3 PK	74.0	-25.7	2.49 V	328	36.4	11.9
6	10600.00	36.0 AV	54.0	-18.0	2.49 V	328	24.1	11.9
7	15900.00	57.9 PK	74.0	-16.1	1.37 V	270	46.6	11.3
8	15900.00	44.7 AV	54.0	-9.3	1.37 V	270	33.4	11.3

Remarks:

1. Emission Level(dBuV/m) = Raw Value(dBuV) + Correction Factor(dB/m)
2. Correction Factor(dB/m) = Antenna Factor(dB/m) + Cable Factor(dB) – Pre-Amplifier Factor(dB)
3. Margin value = Emission Level – Limit value
4. The other emission levels were very low against the limit.
5. " * ": Fundamental frequency.

RF Mode	TX 802.11ax (HE20)	Channel	CH 64 : 5320 MHz
Frequency Range	1GHz ~ 40GHz	Detector Function	Peak (PK) Average (AV)

Antenna Polarity & Test Distance : Horizontal at 3 m

No	Frequency (MHz)	Emission Level (dBuV/m)	Limit (dBuV/m)	Margin (dB)	Antenna Height (m)	Table Angle (Degree)	Raw Value (dBuV)	Correction Factor (dB/m)
1	*5320.00	115.8 PK			1.82 H	146	114.0	1.8
2	*5320.00	104.8 AV			1.82 H	146	103.0	1.8
3	5350.00	67.4 PK	74.0	-6.6	1.82 H	146	65.5	1.9
4	5350.00	52.3 AV	54.0	-1.7	1.82 H	146	50.4	1.9
5	10640.00	48.8 PK	74.0	-25.2	3.65 H	283	37.0	11.8
6	10640.00	37.1 AV	54.0	-16.9	3.65 H	283	25.3	11.8
7	15960.00	59.2 PK	74.0	-14.8	1.53 H	276	47.6	11.6
8	15960.00	45.3 AV	54.0	-8.7	1.53 H	276	33.7	11.6

Antenna Polarity & Test Distance : Vertical at 3 m

No	Frequency (MHz)	Emission Level (dBuV/m)	Limit (dBuV/m)	Margin (dB)	Antenna Height (m)	Table Angle (Degree)	Raw Value (dBuV)	Correction Factor (dB/m)
1	*5320.00	106.1 PK			1.59 V	149	104.3	1.8
2	*5320.00	95.0 AV			1.59 V	149	93.2	1.8
3	5350.00	57.0 PK	74.0	-17.0	1.59 V	149	55.1	1.9
4	5350.00	43.7 AV	54.0	-10.3	1.59 V	149	41.8	1.9
5	10640.00	48.1 PK	74.0	-25.9	2.45 V	345	36.3	11.8
6	10640.00	36.2 AV	54.0	-17.8	2.45 V	345	24.4	11.8
7	15960.00	58.5 PK	74.0	-15.5	1.39 V	293	46.9	11.6
8	15960.00	44.8 AV	54.0	-9.2	1.39 V	293	33.2	11.6

Remarks:

1. Emission Level(dBuV/m) = Raw Value(dBuV) + Correction Factor(dB/m)
2. Correction Factor(dB/m) = Antenna Factor(dB/m) + Cable Factor(dB) – Pre-Amplifier Factor(dB)
3. Margin value = Emission Level – Limit value
4. The other emission levels were very low against the limit.
5. " * ": Fundamental frequency.

RF Mode	TX 802.11ax (HE20)	Channel	CH 100 : 5500 MHz
Frequency Range	1GHz ~ 40GHz	Detector Function	Peak (PK) Average (AV)

Antenna Polarity & Test Distance : Horizontal at 3 m								
No	Frequency (MHz)	Emission Level (dBuV/m)	Limit (dBuV/m)	Margin (dB)	Antenna Height (m)	Table Angle (Degree)	Raw Value (dBuV)	Correction Factor (dB/m)
1	5460.00	59.7 PK	74.0	-14.3	2.10 H	134	57.6	2.1
2	5460.00	44.2 AV	54.0	-9.8	2.10 H	134	42.1	2.1
3	*5500.00	116.3 PK			2.10 H	134	114.2	2.1
4	*5500.00	105.4 AV			2.10 H	134	103.3	2.1
5	#5670.20	66.4 PK	68.2	-1.8	2.10 H	134	64.1	2.3
6	11000.00	48.9 PK	74.0	-25.1	3.72 H	295	36.5	12.4
7	11000.00	37.0 AV	54.0	-17.0	3.72 H	295	24.6	12.4
8	#16500.00	59.0 PK	68.2	-9.2	1.58 H	296	45.3	13.7

Antenna Polarity & Test Distance : Vertical at 3 m								
No	Frequency (MHz)	Emission Level (dBuV/m)	Limit (dBuV/m)	Margin (dB)	Antenna Height (m)	Table Angle (Degree)	Raw Value (dBuV)	Correction Factor (dB/m)
1	5460.00	50.6 PK	74.0	-23.4	1.52 V	152	48.5	2.1
2	5460.00	39.0 AV	54.0	-15.0	1.52 V	152	36.9	2.1
3	#5468.30	56.3 PK	68.2	-11.9	1.52 V	152	54.1	2.2
4	*5500.00	107.5 PK			1.52 V	152	105.4	2.1
5	*5500.00	96.5 AV			1.52 V	152	94.4	2.1
6	11000.00	47.9 PK	74.0	-26.1	2.44 V	340	35.5	12.4
7	11000.00	36.1 AV	54.0	-17.9	2.44 V	340	23.7	12.4
8	#16500.00	58.1 PK	68.2	-10.1	1.37 V	271	44.4	13.7

Remarks:

1. Emission Level(dBuV/m) = Raw Value(dBuV) + Correction Factor(dB/m)
2. Correction Factor(dB/m) = Antenna Factor(dB/m) + Cable Factor(dB) – Pre-Amplifier Factor(dB)
3. Margin value = Emission Level – Limit value
4. The other emission levels were very low against the limit.
5. " * ": Fundamental frequency.
6. " # ": The radiated frequency is out of the restricted band.

RF Mode	TX 802.11ax (HE20)	Channel	CH 116 : 5580 MHz
Frequency Range	1GHz ~ 40GHz	Detector Function	Peak (PK) Average (AV)

Antenna Polarity & Test Distance : Horizontal at 3 m

No	Frequency (MHz)	Emission Level (dBuV/m)	Limit (dBuV/m)	Margin (dB)	Antenna Height (m)	Table Angle (Degree)	Raw Value (dBuV)	Correction Factor (dB/m)
1	5460.00	50.0 PK	74.0	-24.0	1.96 H	136	47.9	2.1
2	5460.00	37.7 AV	54.0	-16.3	1.96 H	136	35.6	2.1
3	#5470.00	54.0 PK	68.2	-14.2	1.96 H	136	51.8	2.2
4	*5580.00	117.1 PK			1.96 H	136	115.0	2.1
5	*5580.00	106.1 AV			1.96 H	136	104.0	2.1
6	11160.00	49.0 PK	74.0	-25.0	3.69 H	295	37.0	12.0
7	11160.00	37.3 AV	54.0	-16.7	3.69 H	295	25.3	12.0
8	#16740.00	58.4 PK	68.2	-9.8	1.48 H	292	43.1	15.3

Antenna Polarity & Test Distance : Vertical at 3 m

No	Frequency (MHz)	Emission Level (dBuV/m)	Limit (dBuV/m)	Margin (dB)	Antenna Height (m)	Table Angle (Degree)	Raw Value (dBuV)	Correction Factor (dB/m)
1	5460.00	48.8 PK	74.0	-25.2	1.44 V	116	46.7	2.1
2	5460.00	37.1 AV	54.0	-16.9	1.44 V	116	35.0	2.1
3	#5470.00	53.3 PK	68.2	-14.9	1.44 V	116	51.1	2.2
4	*5580.00	108.4 PK			1.44 V	116	106.3	2.1
5	*5580.00	98.9 AV			1.44 V	116	96.8	2.1
6	11160.00	48.4 PK	74.0	-25.6	2.49 V	351	36.4	12.0
7	11160.00	36.3 AV	54.0	-17.7	2.49 V	351	24.3	12.0
8	#16740.00	58.4 PK	68.2	-9.8	1.42 V	287	43.1	15.3

Remarks:

1. Emission Level(dBuV/m) = Raw Value(dBuV) + Correction Factor(dB/m)
2. Correction Factor(dB/m) = Antenna Factor(dB/m) + Cable Factor(dB) – Pre-Amplifier Factor(dB)
3. Margin value = Emission Level – Limit value
4. The other emission levels were very low against the limit.
5. " * ": Fundamental frequency.
6. " # ": The radiated frequency is out of the restricted band.

RF Mode	TX 802.11ax (HE20)	Channel	CH 140 : 5700 MHz
Frequency Range	1GHz ~ 40GHz	Detector Function	Peak (PK) Average (AV)

Antenna Polarity & Test Distance : Horizontal at 3 m

No	Frequency (MHz)	Emission Level (dBuV/m)	Limit (dBuV/m)	Margin (dB)	Antenna Height (m)	Table Angle (Degree)	Raw Value (dBuV)	Correction Factor (dB/m)
1	*5700.00	114.3 PK			1.98 H	129	112.0	2.3
2	*5700.00	103.2 AV			1.98 H	129	100.9	2.3
3	#5725.00	66.6 PK	68.2	-1.6	1.98 H	129	64.2	2.4
4	11400.00	49.7 PK	74.0	-24.3	3.66 H	285	37.2	12.5
5	11400.00	37.7 AV	54.0	-16.3	3.66 H	285	25.2	12.5
6	#17100.00	57.9 PK	68.2	-10.3	1.49 H	297	41.1	16.8

Antenna Polarity & Test Distance : Vertical at 3 m

No	Frequency (MHz)	Emission Level (dBuV/m)	Limit (dBuV/m)	Margin (dB)	Antenna Height (m)	Table Angle (Degree)	Raw Value (dBuV)	Correction Factor (dB/m)
1	*5700.00	105.1 PK			1.37 V	110	102.8	2.3
2	*5700.00	95.6 AV			1.37 V	110	93.3	2.3
3	#5725.00	57.2 PK	68.2	-11.0	1.37 V	110	54.8	2.4
4	11400.00	48.0 PK	74.0	-26.0	2.55 V	321	35.5	12.5
5	11400.00	35.9 AV	54.0	-18.1	2.55 V	321	23.4	12.5
6	#17100.00	57.6 PK	68.2	-10.6	1.46 V	276	40.8	16.8

Remarks:

1. Emission Level(dBuV/m) = Raw Value(dBuV) + Correction Factor(dB/m)
2. Correction Factor(dB/m) = Antenna Factor(dB/m) + Cable Factor(dB) – Pre-Amplifier Factor(dB)
3. Margin value = Emission Level – Limit value
4. The other emission levels were very low against the limit.
5. " * ": Fundamental frequency.
6. " # ": The radiated frequency is out of the restricted band.

RF Mode	TX 802.11ax (HE20)	Channel	CH 144 : 5720 MHz
Frequency Range	1GHz ~ 40GHz	Detector Function	Peak (PK) Average (AV)

Antenna Polarity & Test Distance : Horizontal at 3 m

No	Frequency (MHz)	Emission Level (dBuV/m)	Limit (dBuV/m)	Margin (dB)	Antenna Height (m)	Table Angle (Degree)	Raw Value (dBuV)	Correction Factor (dB/m)
1	5460.00	50.7 PK	74.0	-23.3	1.97 H	119	48.6	2.1
2	5460.00	38.8 AV	54.0	-15.2	1.97 H	119	36.7	2.1
3	#5470.00	51.7 PK	68.2	-16.5	1.97 H	119	49.5	2.2
4	*5720.00	116.8 PK			1.97 H	119	114.4	2.4
5	*5720.00	105.8 AV			1.97 H	119	103.4	2.4
6	#5850.00	50.7 PK	68.2	-17.5	1.97 H	119	48.0	2.7
7	11440.00	49.3 PK	74.0	-24.7	3.64 H	297	36.9	12.4
8	11440.00	37.1 AV	54.0	-16.9	3.64 H	297	24.7	12.4
9	#17160.00	58.6 PK	68.2	-9.6	1.54 H	287	42.0	16.6

Antenna Polarity & Test Distance : Vertical at 3 m

No	Frequency (MHz)	Emission Level (dBuV/m)	Limit (dBuV/m)	Margin (dB)	Antenna Height (m)	Table Angle (Degree)	Raw Value (dBuV)	Correction Factor (dB/m)
1	5460.00	50.1 PK	74.0	-23.9	1.39 V	130	48.0	2.1
2	5460.00	37.8 AV	54.0	-16.2	1.39 V	130	35.7	2.1
3	#5470.00	50.8 PK	68.2	-17.4	1.39 V	130	48.6	2.2
4	*5720.00	108.1 PK			1.39 V	130	105.7	2.4
5	*5720.00	98.5 AV			1.39 V	130	96.1	2.4
6	#5850.00	49.9 PK	68.2	-18.3	1.39 V	130	47.2	2.7
7	11440.00	48.7 PK	74.0	-25.3	2.49 V	340	36.3	12.4
8	11440.00	36.5 AV	54.0	-17.5	2.49 V	340	24.1	12.4
9	#17160.00	58.1 PK	68.2	-10.1	1.43 V	287	41.5	16.6

Remarks:

1. Emission Level(dBuV/m) = Raw Value(dBuV) + Correction Factor(dB/m)
2. Correction Factor(dB/m) = Antenna Factor(dB/m) + Cable Factor(dB) – Pre-Amplifier Factor(dB)
3. Margin value = Emission Level – Limit value
4. The other emission levels were very low against the limit.
5. " * ": Fundamental frequency.
6. " # ": The radiated frequency is out of the restricted band.

RF Mode	TX 802.11ax (HE20)	Channel	CH 149 : 5745 MHz
Frequency Range	1GHz ~ 40GHz	Detector Function	Peak (PK) Average (AV)

Antenna Polarity & Test Distance : Horizontal at 3 m

No	Frequency (MHz)	Emission Level (dBuV/m)	Limit (dBuV/m)	Margin (dB)	Antenna Height (m)	Table Angle (Degree)	Raw Value (dBuV)	Correction Factor (dB/m)
1	#5649.96	53.9 PK	68.2	-14.3	2.05 H	140	51.6	2.3
2	*5745.00	117.7 PK			2.05 H	140	115.3	2.4
3	*5745.00	106.7 AV			2.05 H	140	104.3	2.4
4	#5949.91	51.7 PK	68.2	-16.5	2.05 H	140	48.8	2.9
5	11490.00	48.7 PK	74.0	-25.3	3.61 H	307	36.1	12.6
6	11490.00	36.9 AV	54.0	-17.1	3.61 H	307	24.3	12.6
7	#17235.00	58.9 PK	68.2	-9.3	1.46 H	284	42.1	16.8

Antenna Polarity & Test Distance : Vertical at 3 m

No	Frequency (MHz)	Emission Level (dBuV/m)	Limit (dBuV/m)	Margin (dB)	Antenna Height (m)	Table Angle (Degree)	Raw Value (dBuV)	Correction Factor (dB/m)
1	#5586.18	51.2 PK	68.2	-17.0	1.49 V	147	49.1	2.1
2	*5745.00	109.8 PK			1.49 V	147	107.4	2.4
3	*5745.00	98.9 AV			1.49 V	147	96.5	2.4
4	#5951.65	51.0 PK	68.2	-17.2	1.49 V	147	48.1	2.9
5	11490.00	48.3 PK	74.0	-25.7	2.44 V	349	35.7	12.6
6	11490.00	36.3 AV	54.0	-17.7	2.44 V	349	23.7	12.6
7	#17235.00	57.9 PK	68.2	-10.3	1.37 V	281	41.1	16.8

Remarks:

1. Emission Level(dBuV/m) = Raw Value(dBuV) + Correction Factor(dB/m)
2. Correction Factor(dB/m) = Antenna Factor(dB/m) + Cable Factor(dB) – Pre-Amplifier Factor(dB)
3. Margin value = Emission Level – Limit value
4. The other emission levels were very low against the limit.
5. " * ": Fundamental frequency.
6. " # ": The radiated frequency is out of the restricted band.

RF Mode	TX 802.11ax (HE20)	Channel	CH 157 : 5785 MHz
Frequency Range	1GHz ~ 40GHz	Detector Function	Peak (PK) Average (AV)

Antenna Polarity & Test Distance : Horizontal at 3 m

No	Frequency (MHz)	Emission Level (dBuV/m)	Limit (dBuV/m)	Margin (dB)	Antenna Height (m)	Table Angle (Degree)	Raw Value (dBuV)	Correction Factor (dB/m)
1	#5568.00	52.0 PK	68.2	-16.2	2.07 H	150	49.9	2.1
2	*5785.00	118.1 PK			2.07 H	150	115.5	2.6
3	*5785.00	106.9 AV			2.07 H	150	104.3	2.6
4	#5954.33	51.5 PK	68.2	-16.7	2.07 H	150	48.6	2.9
5	11570.00	48.7 PK	74.0	-25.3	3.62 H	311	36.1	12.6
6	11570.00	36.9 AV	54.0	-17.1	3.62 H	311	24.3	12.6
7	#17355.00	58.8 PK	68.2	-9.4	1.49 H	266	41.1	17.7

Antenna Polarity & Test Distance : Vertical at 3 m

No	Frequency (MHz)	Emission Level (dBuV/m)	Limit (dBuV/m)	Margin (dB)	Antenna Height (m)	Table Angle (Degree)	Raw Value (dBuV)	Correction Factor (dB/m)
1	#5581.41	51.1 PK	68.2	-17.1	1.53 V	153	49.0	2.1
2	*5785.00	110.1 PK			1.53 V	153	107.5	2.6
3	*5785.00	99.2 AV			1.53 V	153	96.6	2.6
4	#5947.88	51.8 PK	68.2	-16.4	1.53 V	153	48.9	2.9
5	11570.00	49.0 PK	74.0	-25.0	2.48 V	343	36.4	12.6
6	11570.00	36.7 AV	54.0	-17.3	2.48 V	343	24.1	12.6
7	#17355.00	58.4 PK	68.2	-9.8	1.43 V	274	40.7	17.7

Remarks:

1. Emission Level(dBuV/m) = Raw Value(dBuV) + Correction Factor(dB/m)
2. Correction Factor(dB/m) = Antenna Factor(dB/m) + Cable Factor(dB) – Pre-Amplifier Factor(dB)
3. Margin value = Emission Level – Limit value
4. The other emission levels were very low against the limit.
5. " * ": Fundamental frequency.
6. " # ": The radiated frequency is out of the restricted band.

RF Mode	TX 802.11ax (HE20)	Channel	CH 165 : 5825 MHz
Frequency Range	1GHz ~ 40GHz	Detector Function	Peak (PK) Average (AV)

Antenna Polarity & Test Distance : Horizontal at 3 m

No	Frequency (MHz)	Emission Level (dBuV/m)	Limit (dBuV/m)	Margin (dB)	Antenna Height (m)	Table Angle (Degree)	Raw Value (dBuV)	Correction Factor (dB/m)
1	#5607.85	52.1 PK	68.2	-16.1	2.02 H	138	50.0	2.1
2	*5825.00	117.5 PK			2.02 H	138	114.9	2.6
3	*5825.00	106.6 AV			2.02 H	138	104.0	2.6
4	#5928.03	53.3 PK	68.2	-14.9	2.02 H	138	50.4	2.9
5	11650.00	49.2 PK	74.0	-24.8	3.65 H	299	37.0	12.2
6	11650.00	37.4 AV	54.0	-16.6	3.65 H	299	25.2	12.2
7	#17475.00	58.5 PK	68.2	-9.7	1.54 H	269	39.8	18.7

Antenna Polarity & Test Distance : Vertical at 3 m

No	Frequency (MHz)	Emission Level (dBuV/m)	Limit (dBuV/m)	Margin (dB)	Antenna Height (m)	Table Angle (Degree)	Raw Value (dBuV)	Correction Factor (dB/m)
1	#5568.19	50.8 PK	68.2	-17.4	1.58 V	136	48.7	2.1
2	*5825.00	109.6 PK			1.58 V	136	107.0	2.6
3	*5825.00	98.7 AV			1.58 V	136	96.1	2.6
4	#5930.34	50.4 PK	68.2	-17.8	1.58 V	136	47.5	2.9
5	11650.00	48.1 PK	74.0	-25.9	2.44 V	345	35.9	12.2
6	11650.00	36.3 AV	54.0	-17.7	2.44 V	345	24.1	12.2
7	#17475.00	58.5 PK	68.2	-9.7	1.46 V	291	39.8	18.7

Remarks:

1. Emission Level(dBuV/m) = Raw Value(dBuV) + Correction Factor(dB/m)
2. Correction Factor(dB/m) = Antenna Factor(dB/m) + Cable Factor(dB) – Pre-Amplifier Factor(dB)
3. Margin value = Emission Level – Limit value
4. The other emission levels were very low against the limit.
5. " * ": Fundamental frequency.
6. " # ": The radiated frequency is out of the restricted band.

RF Mode	TX 802.11ax (HE40)	Channel	CH 38 : 5190 MHz
Frequency Range	1GHz ~ 40GHz	Detector Function	Peak (PK) Average (AV)

Antenna Polarity & Test Distance : Horizontal at 3 m								
No	Frequency (MHz)	Emission Level (dBuV/m)	Limit (dBuV/m)	Margin (dB)	Antenna Height (m)	Table Angle (Degree)	Raw Value (dBuV)	Correction Factor (dB/m)
1	5150.00	67.6 PK	74.0	-6.4	2.02 H	128	65.3	2.3
2	5150.00	52.4 AV	54.0	-1.6	2.02 H	128	50.1	2.3
3	*5190.00	112.1 PK			2.02 H	128	110.0	2.1
4	*5190.00	99.9 AV			2.02 H	128	97.8	2.1
5	#10380.00	50.2 PK	68.2	-18.0	3.61 H	312	38.2	12.0
6	15570.00	58.6 PK	74.0	-15.4	1.54 H	268	46.9	11.7
7	15570.00	45.0 AV	54.0	-9.0	1.54 H	268	33.3	11.7

Antenna Polarity & Test Distance : Vertical at 3 m								
No	Frequency (MHz)	Emission Level (dBuV/m)	Limit (dBuV/m)	Margin (dB)	Antenna Height (m)	Table Angle (Degree)	Raw Value (dBuV)	Correction Factor (dB/m)
1	5150.00	59.4 PK	74.0	-14.6	1.60 V	89	57.1	2.3
2	5150.00	46.8 AV	54.0	-7.2	1.60 V	89	44.5	2.3
3	*5190.00	105.2 PK			1.60 V	89	103.1	2.1
4	*5190.00	93.5 AV			1.60 V	89	91.4	2.1
5	#10380.00	48.5 PK	68.2	-19.7	2.49 V	350	36.5	12.0
6	15570.00	58.5 PK	74.0	-15.5	1.37 V	293	46.8	11.7
7	15570.00	45.0 AV	54.0	-9.0	1.37 V	293	33.3	11.7

Remarks:

1. Emission Level(dBuV/m) = Raw Value(dBuV) + Correction Factor(dB/m)
2. Correction Factor(dB/m) = Antenna Factor(dB/m) + Cable Factor(dB) – Pre-Amplifier Factor(dB)
3. Margin value = Emission Level – Limit value
4. The other emission levels were very low against the limit.
5. " * ": Fundamental frequency.
6. " # ": The radiated frequency is out of the restricted band.

RF Mode	TX 802.11ax (HE40)	Channel	CH 46 : 5230 MHz
Frequency Range	1GHz ~ 40GHz	Detector Function	Peak (PK) Average (AV)

Antenna Polarity & Test Distance : Horizontal at 3 m

No	Frequency (MHz)	Emission Level (dBuV/m)	Limit (dBuV/m)	Margin (dB)	Antenna Height (m)	Table Angle (Degree)	Raw Value (dBuV)	Correction Factor (dB/m)
1	5150.00	66.3 PK	74.0	-7.7	1.99 H	131	64.0	2.3
2	5150.00	45.6 AV	54.0	-8.4	1.99 H	131	43.3	2.3
3	*5230.00	115.3 PK			1.99 H	131	113.2	2.1
4	*5230.00	103.4 AV			1.99 H	131	101.3	2.1
5	#10460.00	49.7 PK	68.2	-18.5	3.66 H	293	37.7	12.0
6	15690.00	58.9 PK	74.0	-15.1	1.47 H	276	47.0	11.9
7	15690.00	45.3 AV	54.0	-8.7	1.47 H	276	33.4	11.9

Antenna Polarity & Test Distance : Vertical at 3 m

No	Frequency (MHz)	Emission Level (dBuV/m)	Limit (dBuV/m)	Margin (dB)	Antenna Height (m)	Table Angle (Degree)	Raw Value (dBuV)	Correction Factor (dB/m)
1	5150.00	63.9 PK	74.0	-10.1	1.36 V	119	61.6	2.3
2	5150.00	43.8 AV	54.0	-10.2	1.36 V	119	41.5	2.3
3	*5230.00	108.3 PK			1.36 V	119	106.2	2.1
4	*5230.00	96.9 AV			1.36 V	119	94.8	2.1
5	#10460.00	47.9 PK	68.2	-20.3	2.52 V	341	35.9	12.0
6	15690.00	58.1 PK	74.0	-15.9	1.41 V	285	46.2	11.9
7	15690.00	44.4 AV	54.0	-9.6	1.41 V	285	32.5	11.9

Remarks:

1. Emission Level(dBuV/m) = Raw Value(dBuV) + Correction Factor(dB/m)
2. Correction Factor(dB/m) = Antenna Factor(dB/m) + Cable Factor(dB) – Pre-Amplifier Factor(dB)
3. Margin value = Emission Level – Limit value
4. The other emission levels were very low against the limit.
5. " * ": Fundamental frequency.
6. " # ": The radiated frequency is out of the restricted band.

RF Mode	TX 802.11ax (HE40)	Channel	CH 54 : 5270 MHz
Frequency Range	1GHz ~ 40GHz	Detector Function	Peak (PK) Average (AV)

Antenna Polarity & Test Distance : Horizontal at 3 m

No	Frequency (MHz)	Emission Level (dBuV/m)	Limit (dBuV/m)	Margin (dB)	Antenna Height (m)	Table Angle (Degree)	Raw Value (dBuV)	Correction Factor (dB/m)
1	*5270.00	115.2 PK			1.93 H	135	113.3	1.9
2	*5270.00	103.1 AV			1.93 H	135	101.2	1.9
3	5350.00	67.1 PK	74.0	-6.9	1.93 H	135	65.2	1.9
4	5350.00	47.4 AV	54.0	-6.6	1.93 H	135	45.5	1.9
5	#10540.00	49.6 PK	68.2	-18.6	3.69 H	302	37.7	11.9
6	15810.00	58.7 PK	74.0	-15.3	1.50 H	284	47.3	11.4
7	15810.00	44.7 AV	54.0	-9.3	1.50 H	284	33.3	11.4

Antenna Polarity & Test Distance : Vertical at 3 m

No	Frequency (MHz)	Emission Level (dBuV/m)	Limit (dBuV/m)	Margin (dB)	Antenna Height (m)	Table Angle (Degree)	Raw Value (dBuV)	Correction Factor (dB/m)
1	*5270.00	107.9 PK			1.34 V	123	106.0	1.9
2	*5270.00	96.7 AV			1.34 V	123	94.8	1.9
3	5350.00	64.7 PK	74.0	-9.3	1.34 V	123	62.8	1.9
4	5350.00	45.6 AV	54.0	-8.4	1.34 V	123	43.7	1.9
5	#10540.00	48.5 PK	68.2	-19.7	2.52 V	321	36.6	11.9
6	15810.00	58.2 PK	74.0	-15.8	1.39 V	267	46.8	11.4
7	15810.00	44.8 AV	54.0	-9.2	1.39 V	267	33.4	11.4

Remarks:

1. Emission Level(dBuV/m) = Raw Value(dBuV) + Correction Factor(dB/m)
2. Correction Factor(dB/m) = Antenna Factor(dB/m) + Cable Factor(dB) – Pre-Amplifier Factor(dB)
3. Margin value = Emission Level – Limit value
4. The other emission levels were very low against the limit.
5. " * ": Fundamental frequency.
6. " # ": The radiated frequency is out of the restricted band.

RF Mode	TX 802.11ax (HE40)	Channel	CH 62 : 5310 MHz
Frequency Range	1GHz ~ 40GHz	Detector Function	Peak (PK) Average (AV)

Antenna Polarity & Test Distance : Horizontal at 3 m

No	Frequency (MHz)	Emission Level (dBuV/m)	Limit (dBuV/m)	Margin (dB)	Antenna Height (m)	Table Angle (Degree)	Raw Value (dBuV)	Correction Factor (dB/m)
1	*5310.00	111.8 PK			1.98 H	134	110.0	1.8
2	*5310.00	99.8 AV			1.98 H	134	98.0	1.8
3	5350.00	69.5 PK	74.0	-4.5	1.98 H	134	67.6	1.9
4	5350.00	52.3 AV	54.0	-1.7	1.98 H	134	50.4	1.9
5	10620.00	48.7 PK	74.0	-25.3	3.67 H	311	36.9	11.8
6	10620.00	37.0 AV	54.0	-17.0	3.67 H	311	25.2	11.8
7	15930.00	59.1 PK	74.0	-14.9	1.46 H	285	47.6	11.5
8	15930.00	45.2 AV	54.0	-8.8	1.46 H	285	33.7	11.5

Antenna Polarity & Test Distance : Vertical at 3 m

No	Frequency (MHz)	Emission Level (dBuV/m)	Limit (dBuV/m)	Margin (dB)	Antenna Height (m)	Table Angle (Degree)	Raw Value (dBuV)	Correction Factor (dB/m)
1	*5310.00	105.5 PK			1.57 V	92	103.7	1.8
2	*5310.00	93.7 AV			1.57 V	92	91.9	1.8
3	5350.00	63.8 PK	74.0	-10.2	1.57 V	92	61.9	1.9
4	5350.00	44.9 AV	54.0	-9.1	1.57 V	92	43.0	1.9
5	5356.00	65.7 PK	74.0	-8.3	1.57 V	92	63.7	2.0
6	5356.00	44.0 AV	54.0	-10.0	1.57 V	92	42.0	2.0
7	10620.00	48.5 PK	74.0	-25.5	2.52 V	316	36.7	11.8
8	10620.00	36.1 AV	54.0	-17.9	2.52 V	316	24.3	11.8
9	15930.00	57.9 PK	74.0	-16.1	1.35 V	258	46.4	11.5
10	15930.00	44.3 AV	54.0	-9.7	1.35 V	258	32.8	11.5

Remarks:

1. Emission Level(dBuV/m) = Raw Value(dBuV) + Correction Factor(dB/m)
2. Correction Factor(dB/m) = Antenna Factor(dB/m) + Cable Factor(dB) – Pre-Amplifier Factor(dB)
3. Margin value = Emission Level – Limit value
4. The other emission levels were very low against the limit.
5. " * ": Fundamental frequency.

RF Mode	TX 802.11ax (HE40)	Channel	CH 102 : 5510 MHz
Frequency Range	1GHz ~ 40GHz	Detector Function	Peak (PK) Average (AV)

Antenna Polarity & Test Distance : Horizontal at 3 m

No	Frequency (MHz)	Emission Level (dBuV/m)	Limit (dBuV/m)	Margin (dB)	Antenna Height (m)	Table Angle (Degree)	Raw Value (dBuV)	Correction Factor (dB/m)
1	5460.00	60.2 PK	74.0	-13.8	1.97 H	132	58.1	2.1
2	5460.00	46.0 AV	54.0	-8.0	1.97 H	132	43.9	2.1
3	#5467.25	66.7 PK	68.2	-1.5	1.97 H	132	64.5	2.2
4	*5510.00	110.5 PK			1.97 H	132	108.4	2.1
5	*5510.00	98.8 AV			1.97 H	132	96.7	2.1
6	11020.00	49.5 PK	74.0	-24.5	3.62 H	286	37.2	12.3
7	11020.00	37.5 AV	54.0	-16.5	3.62 H	286	25.2	12.3
8	#16530.00	58.7 PK	68.2	-9.5	1.58 H	274	44.8	13.9

Antenna Polarity & Test Distance : Vertical at 3 m

No	Frequency (MHz)	Emission Level (dBuV/m)	Limit (dBuV/m)	Margin (dB)	Antenna Height (m)	Table Angle (Degree)	Raw Value (dBuV)	Correction Factor (dB/m)
1	5456.24	54.9 PK	74.0	-19.1	1.55 V	96	52.8	2.1
2	5456.24	39.9 AV	54.0	-14.1	1.55 V	96	37.8	2.1
3	5460.00	52.3 PK	74.0	-21.7	1.55 V	96	50.2	2.1
4	5460.00	40.7 AV	54.0	-13.3	1.55 V	96	38.6	2.1
5	#5467.60	61.0 PK	68.2	-7.2	1.55 V	96	58.8	2.2
6	*5510.00	104.2 PK			1.55 V	96	102.1	2.1
7	*5510.00	92.8 AV			1.55 V	96	90.7	2.1
8	11020.00	48.6 PK	74.0	-25.4	2.55 V	331	36.3	12.3
9	11020.00	36.7 AV	54.0	-17.3	2.55 V	331	24.4	12.3
10	#16530.00	58.0 PK	68.2	-10.2	1.44 V	267	44.1	13.9

Remarks:

1. Emission Level(dBuV/m) = Raw Value(dBuV) + Correction Factor(dB/m)
2. Correction Factor(dB/m) = Antenna Factor(dB/m) + Cable Factor(dB) – Pre-Amplifier Factor(dB)
3. Margin value = Emission Level – Limit value
4. The other emission levels were very low against the limit.
5. " * ": Fundamental frequency.
6. " # ": The radiated frequency is out of the restricted band.

RF Mode	TX 802.11ax (HE40)	Channel	CH 110 : 5550 MHz
Frequency Range	1GHz ~ 40GHz	Detector Function	Peak (PK) Average (AV)

Antenna Polarity & Test Distance : Horizontal at 3 m

No	Frequency (MHz)	Emission Level (dBuV/m)	Limit (dBuV/m)	Margin (dB)	Antenna Height (m)	Table Angle (Degree)	Raw Value (dBuV)	Correction Factor (dB/m)
1	5460.00	58.5 PK	74.0	-15.5	1.89 H	129	56.4	2.1
2	5460.00	42.5 AV	54.0	-11.5	1.89 H	129	40.4	2.1
3	#5470.00	64.5 PK	68.2	-3.7	1.89 H	129	62.3	2.2
4	*5550.00	114.5 PK			1.89 H	129	112.4	2.1
5	*5550.00	102.7 AV			1.89 H	129	100.6	2.1
6	11100.00	49.8 PK	74.0	-24.2	3.72 H	290	37.9	11.9
7	11100.00	37.8 AV	54.0	-16.2	3.72 H	290	25.9	11.9
8	#16650.00	58.3 PK	68.2	-9.9	1.52 H	292	43.5	14.8

Antenna Polarity & Test Distance : Vertical at 3 m

No	Frequency (MHz)	Emission Level (dBuV/m)	Limit (dBuV/m)	Margin (dB)	Antenna Height (m)	Table Angle (Degree)	Raw Value (dBuV)	Correction Factor (dB/m)
1	5460.00	56.9 PK	74.0	-17.1	1.38 V	135	54.8	2.1
2	5460.00	40.9 AV	54.0	-13.1	1.38 V	135	38.8	2.1
3	#5470.00	60.4 PK	68.2	-7.8	1.38 V	135	58.2	2.2
4	*5550.00	108.3 PK			1.38 V	135	106.2	2.1
5	*5550.00	96.9 AV			1.38 V	135	94.8	2.1
6	11100.00	48.4 PK	74.0	-25.6	2.55 V	339	36.5	11.9
7	11100.00	36.3 AV	54.0	-17.7	2.55 V	339	24.4	11.9
8	#16650.00	58.4 PK	68.2	-9.8	1.47 V	281	43.6	14.8

Remarks:

1. Emission Level(dBuV/m) = Raw Value(dBuV) + Correction Factor(dB/m)
2. Correction Factor(dB/m) = Antenna Factor(dB/m) + Cable Factor(dB) – Pre-Amplifier Factor(dB)
3. Margin value = Emission Level – Limit value
4. The other emission levels were very low against the limit.
5. " * ": Fundamental frequency.
6. " # ": The radiated frequency is out of the restricted band.

RF Mode	TX 802.11ax (HE40)	Channel	CH 134 : 5670 MHz
Frequency Range	1GHz ~ 40GHz	Detector Function	Peak (PK) Average (AV)

Antenna Polarity & Test Distance : Horizontal at 3 m

No	Frequency (MHz)	Emission Level (dBuV/m)	Limit (dBuV/m)	Margin (dB)	Antenna Height (m)	Table Angle (Degree)	Raw Value (dBuV)	Correction Factor (dB/m)
1	*5670.00	114.4 PK			2.00 H	117	112.1	2.3
2	*5670.00	102.2 AV			2.00 H	117	99.9	2.3
3	#5736.69	66.7 PK	68.2	-1.5	2.00 H	117	64.2	2.5
4	11340.00	49.7 PK	74.0	-24.3	3.62 H	306	37.5	12.2
5	11340.00	37.5 AV	54.0	-16.5	3.62 H	306	25.3	12.2
6	#17010.00	58.3 PK	68.2	-9.9	1.53 H	270	41.7	16.6

Antenna Polarity & Test Distance : Vertical at 3 m

No	Frequency (MHz)	Emission Level (dBuV/m)	Limit (dBuV/m)	Margin (dB)	Antenna Height (m)	Table Angle (Degree)	Raw Value (dBuV)	Correction Factor (dB/m)
1	*5670.00	107.6 PK			1.35 V	121	105.3	2.3
2	*5670.00	96.1 AV			1.35 V	121	93.8	2.3
3	#5725.60	58.9 PK	68.2	-9.3	1.35 V	121	56.5	2.4
4	11340.00	48.3 PK	74.0	-25.7	2.58 V	339	36.1	12.2
5	11340.00	36.6 AV	54.0	-17.4	2.58 V	339	24.4	12.2
6	#17010.00	57.6 PK	68.2	-10.6	1.42 V	255	41.0	16.6

Remarks:

1. Emission Level(dBuV/m) = Raw Value(dBuV) + Correction Factor(dB/m)
2. Correction Factor(dB/m) = Antenna Factor(dB/m) + Cable Factor(dB) – Pre-Amplifier Factor(dB)
3. Margin value = Emission Level – Limit value
4. The other emission levels were very low against the limit.
5. " * ": Fundamental frequency.
6. " # ": The radiated frequency is out of the restricted band.

RF Mode	TX 802.11ax (HE40)	Channel	CH 142 : 5710 MHz
Frequency Range	1GHz ~ 40GHz	Detector Function	Peak (PK) Average (AV)

Antenna Polarity & Test Distance : Horizontal at 3 m

No	Frequency (MHz)	Emission Level (dBuV/m)	Limit (dBuV/m)	Margin (dB)	Antenna Height (m)	Table Angle (Degree)	Raw Value (dBuV)	Correction Factor (dB/m)
1	5460.00	52.7 PK	74.0	-21.3	2.00 H	136	50.6	2.1
2	5460.00	38.8 AV	54.0	-15.2	2.00 H	136	36.7	2.1
3	#5470.00	53.4 PK	68.2	-14.8	2.00 H	136	51.2	2.2
4	*5710.00	114.1 PK			2.00 H	136	111.7	2.4
5	*5710.00	102.2 AV			2.00 H	136	99.8	2.4
6	#5850.00	55.7 PK	68.2	-12.5	2.00 H	136	53.0	2.7
7	11420.00	49.7 PK	74.0	-24.3	3.70 H	305	37.2	12.5
8	11420.00	37.8 AV	54.0	-16.2	3.70 H	305	25.3	12.5
9	#17130.00	58.0 PK	68.2	-10.2	1.49 H	295	41.2	16.8

Antenna Polarity & Test Distance : Vertical at 3 m

No	Frequency (MHz)	Emission Level (dBuV/m)	Limit (dBuV/m)	Margin (dB)	Antenna Height (m)	Table Angle (Degree)	Raw Value (dBuV)	Correction Factor (dB/m)
1	5460.00	51.6 PK	74.0	-22.4	1.42 V	132	49.5	2.1
2	5460.00	37.8 AV	54.0	-16.2	1.42 V	132	35.7	2.1
3	#5470.00	52.8 PK	68.2	-15.4	1.42 V	132	50.6	2.2
4	*5710.00	107.8 PK			1.42 V	132	105.4	2.4
5	*5710.00	96.3 AV			1.42 V	132	93.9	2.4
6	#5850.00	53.4 PK	68.2	-14.8	1.42 V	132	50.7	2.7
7	11420.00	48.5 PK	74.0	-25.5	2.52 V	347	36.0	12.5
8	11420.00	36.5 AV	54.0	-17.5	2.52 V	347	24.0	12.5
9	#17130.00	58.4 PK	68.2	-9.8	1.48 V	265	41.6	16.8

Remarks:

1. Emission Level(dBuV/m) = Raw Value(dBuV) + Correction Factor(dB/m)
2. Correction Factor(dB/m) = Antenna Factor(dB/m) + Cable Factor(dB) – Pre-Amplifier Factor(dB)
3. Margin value = Emission Level – Limit value
4. The other emission levels were very low against the limit.
5. " * ": Fundamental frequency.
6. " # ": The radiated frequency is out of the restricted band.

RF Mode	TX 802.11ax (HE40)	Channel	CH 151 : 5755 MHz
Frequency Range	1GHz ~ 40GHz	Detector Function	Peak (PK) Average (AV)

Antenna Polarity & Test Distance : Horizontal at 3 m

No	Frequency (MHz)	Emission Level (dBuV/m)	Limit (dBuV/m)	Margin (dB)	Antenna Height (m)	Table Angle (Degree)	Raw Value (dBuV)	Correction Factor (dB/m)
1	#5648.43	60.0 PK	68.2	-8.2	1.88 H	129	57.7	2.3
2	*5755.00	114.4 PK			1.88 H	129	111.9	2.5
3	*5755.00	102.6 AV			1.88 H	129	100.1	2.5
4	#5952.11	53.7 PK	68.2	-14.5	1.88 H	129	50.8	2.9
5	11510.00	48.9 PK	74.0	-25.1	3.62 H	305	36.3	12.6
6	11510.00	37.0 AV	54.0	-17.0	3.62 H	305	24.4	12.6
7	#17265.00	58.1 PK	68.2	-10.1	1.50 H	285	41.2	16.9

Antenna Polarity & Test Distance : Vertical at 3 m

No	Frequency (MHz)	Emission Level (dBuV/m)	Limit (dBuV/m)	Margin (dB)	Antenna Height (m)	Table Angle (Degree)	Raw Value (dBuV)	Correction Factor (dB/m)
1	#5648.15	52.2 PK	68.2	-16.0	1.59 V	89	49.9	2.3
2	*5755.00	108.4 PK			1.59 V	89	105.9	2.5
3	*5755.00	96.8 AV			1.59 V	89	94.3	2.5
4	#5972.52	50.7 PK	68.2	-17.5	1.59 V	89	47.8	2.9
5	11510.00	48.9 PK	74.0	-25.1	2.60 V	331	36.3	12.6
6	11510.00	36.9 AV	54.0	-17.1	2.60 V	331	24.3	12.6
7	#17265.00	57.9 PK	68.2	-10.3	1.46 V	261	41.0	16.9

Remarks:

1. Emission Level(dBuV/m) = Raw Value(dBuV) + Correction Factor(dB/m)
2. Correction Factor(dB/m) = Antenna Factor(dB/m) + Cable Factor(dB) – Pre-Amplifier Factor(dB)
3. Margin value = Emission Level – Limit value
4. The other emission levels were very low against the limit.
5. " * ": Fundamental frequency.
6. " # ": The radiated frequency is out of the restricted band.

RF Mode	TX 802.11ax (HE40)	Channel	CH 159 : 5795 MHz
Frequency Range	1GHz ~ 40GHz	Detector Function	Peak (PK) Average (AV)

Antenna Polarity & Test Distance : Horizontal at 3 m

No	Frequency (MHz)	Emission Level (dBuV/m)	Limit (dBuV/m)	Margin (dB)	Antenna Height (m)	Table Angle (Degree)	Raw Value (dBuV)	Correction Factor (dB/m)
1	#5649.25	52.6 PK	68.2	-15.6	1.91 H	132	50.3	2.3
2	*5795.00	114.7 PK			1.91 H	132	112.1	2.6
3	*5795.00	102.8 AV			1.91 H	132	100.2	2.6
4	#5925.56	56.1 PK	68.2	-12.1	1.91 H	132	53.2	2.9
5	11590.00	49.5 PK	74.0	-24.5	3.67 H	309	36.9	12.6
6	11590.00	37.8 AV	54.0	-16.2	3.67 H	309	25.2	12.6
7	#17385.00	58.0 PK	68.2	-10.2	1.55 H	279	40.1	17.9

Antenna Polarity & Test Distance : Vertical at 3 m

No	Frequency (MHz)	Emission Level (dBuV/m)	Limit (dBuV/m)	Margin (dB)	Antenna Height (m)	Table Angle (Degree)	Raw Value (dBuV)	Correction Factor (dB/m)
1	#5565.18	50.7 PK	68.2	-17.5	1.53 V	79	48.6	2.1
2	*5795.00	108.7 PK			1.53 V	79	106.1	2.6
3	*5795.00	97.1 AV			1.53 V	79	94.5	2.6
4	#5951.03	50.8 PK	68.2	-17.4	1.53 V	79	47.9	2.9
5	11590.00	48.0 PK	74.0	-26.0	2.49 V	329	35.4	12.6
6	11590.00	36.3 AV	54.0	-17.7	2.49 V	329	23.7	12.6
7	#17385.00	57.6 PK	68.2	-10.6	1.46 V	260	39.7	17.9

Remarks:

1. Emission Level(dBuV/m) = Raw Value(dBuV) + Correction Factor(dB/m)
2. Correction Factor(dB/m) = Antenna Factor(dB/m) + Cable Factor(dB) – Pre-Amplifier Factor(dB)
3. Margin value = Emission Level – Limit value
4. The other emission levels were very low against the limit.
5. " * ": Fundamental frequency.
6. " # ": The radiated frequency is out of the restricted band.

RF Mode	TX 802.11ax (HE80)	Channel	CH 42 : 5210 MHz
Frequency Range	1GHz ~ 40GHz	Detector Function	Peak (PK) Average (AV)

Antenna Polarity & Test Distance : Horizontal at 3 m

No	Frequency (MHz)	Emission Level (dBuV/m)	Limit (dBuV/m)	Margin (dB)	Antenna Height (m)	Table Angle (Degree)	Raw Value (dBuV)	Correction Factor (dB/m)
1	5147.10	66.3 PK	74.0	-7.7	1.92 H	138	64.0	2.3
2	5147.10	52.3 AV	54.0	-1.7	1.92 H	138	50.0	2.3
3	*5210.00	106.1 PK			1.92 H	138	104.0	2.1
4	*5210.00	94.5 AV			1.92 H	138	92.4	2.1
5	5350.00	51.4 PK	74.0	-22.6	1.92 H	138	49.5	1.9
6	5350.00	40.4 AV	54.0	-13.6	1.92 H	138	38.5	1.9
7	5358.10	53.1 PK	74.0	-20.9	1.92 H	138	51.1	2.0
8	5358.10	39.7 AV	54.0	-14.3	1.92 H	138	37.7	2.0
9	#10420.00	49.6 PK	68.2	-18.6	3.65 H	299	37.5	12.1
10	15630.00	58.4 PK	74.0	-15.6	1.49 H	293	46.7	11.7
11	15630.00	44.6 AV	54.0	-9.4	1.49 H	293	32.9	11.7

Antenna Polarity & Test Distance : Vertical at 3 m

No	Frequency (MHz)	Emission Level (dBuV/m)	Limit (dBuV/m)	Margin (dB)	Antenna Height (m)	Table Angle (Degree)	Raw Value (dBuV)	Correction Factor (dB/m)
1	5145.38	59.1 PK	74.0	-14.9	1.52 V	100	56.8	2.3
2	5145.38	44.4 AV	54.0	-9.6	1.52 V	100	42.1	2.3
3	*5210.00	98.8 PK			1.52 V	100	96.7	2.1
4	*5210.00	87.4 AV			1.52 V	100	85.3	2.1
5	5350.00	50.0 PK	74.0	-24.0	1.52 V	100	48.1	1.9
6	5350.00	38.3 AV	54.0	-15.7	1.52 V	100	36.4	1.9
7	#10420.00	48.4 PK	68.2	-19.8	2.54 V	320	36.3	12.1
8	15630.00	58.4 PK	74.0	-15.6	1.45 V	268	46.7	11.7
9	15630.00	45.0 AV	54.0	-9.0	1.45 V	268	33.3	11.7

Remarks:

1. Emission Level(dBuV/m) = Raw Value(dBuV) + Correction Factor(dB/m)
2. Correction Factor(dB/m) = Antenna Factor(dB/m) + Cable Factor(dB) – Pre-Amplifier Factor(dB)
3. Margin value = Emission Level – Limit value
4. The other emission levels were very low against the limit.
5. " * ": Fundamental frequency.
6. " # ": The radiated frequency is out of the restricted band.

RF Mode	TX 802.11ax (HE80)	Channel	CH 58 : 5290 MHz
Frequency Range	1GHz ~ 40GHz	Detector Function	Peak (PK) Average (AV)

Antenna Polarity & Test Distance : Horizontal at 3 m

No	Frequency (MHz)	Emission Level (dBuV/m)	Limit (dBuV/m)	Margin (dB)	Antenna Height (m)	Table Angle (Degree)	Raw Value (dBuV)	Correction Factor (dB/m)
1	5150.00	52.0 PK	74.0	-22.0	1.93 H	130	49.7	2.3
2	5150.00	41.9 AV	54.0	-12.1	1.93 H	130	39.6	2.3
3	*5290.00	106.5 PK			1.93 H	130	104.7	1.8
4	*5290.00	95.0 AV			1.93 H	130	93.2	1.8
5	5352.40	64.8 PK	74.0	-9.2	1.93 H	130	62.9	1.9
6	5352.40	52.3 AV	54.0	-1.7	1.93 H	130	50.4	1.9
7	5358.10	67.7 PK	74.0	-6.3	1.93 H	130	65.7	2.0
8	5358.10	51.5 AV	54.0	-2.5	1.93 H	130	49.5	2.0
9	#10580.00	49.4 PK	68.2	-18.8	3.72 H	303	37.6	11.8
10	15870.00	58.5 PK	74.0	-15.5	1.50 H	280	47.2	11.3
11	15870.00	45.0 AV	54.0	-9.0	1.50 H	280	33.7	11.3

Antenna Polarity & Test Distance : Vertical at 3 m

No	Frequency (MHz)	Emission Level (dBuV/m)	Limit (dBuV/m)	Margin (dB)	Antenna Height (m)	Table Angle (Degree)	Raw Value (dBuV)	Correction Factor (dB/m)
1	5150.00	50.0 PK	74.0	-24.0	1.63 V	91	47.7	2.3
2	5150.00	38.8 AV	54.0	-15.2	1.63 V	91	36.5	2.3
3	*5290.00	99.5 PK			1.63 V	91	97.7	1.8
4	*5290.00	88.1 AV			1.63 V	91	86.3	1.8
5	5367.22	57.9 PK	74.0	-16.1	1.63 V	91	55.9	2.0
6	5367.22	44.5 AV	54.0	-9.5	1.63 V	91	42.5	2.0
7	#10580.00	48.8 PK	68.2	-19.4	2.57 V	330	37.0	11.8
8	15870.00	58.6 PK	74.0	-15.4	1.43 V	254	47.3	11.3
9	15870.00	45.1 AV	54.0	-8.9	1.43 V	254	33.8	11.3

Remarks:

1. Emission Level(dBuV/m) = Raw Value(dBuV) + Correction Factor(dB/m)
2. Correction Factor(dB/m) = Antenna Factor(dB/m) + Cable Factor(dB) – Pre-Amplifier Factor(dB)
3. Margin value = Emission Level – Limit value
4. The other emission levels were very low against the limit.
5. " * ": Fundamental frequency.
6. " # ": The radiated frequency is out of the restricted band.

RF Mode	TX 802.11ax (HE80)	Channel	CH 106 : 5530 MHz
Frequency Range	1GHz ~ 40GHz	Detector Function	Peak (PK) Average (AV)

Antenna Polarity & Test Distance : Horizontal at 3 m

No	Frequency (MHz)	Emission Level (dBuV/m)	Limit (dBuV/m)	Margin (dB)	Antenna Height (m)	Table Angle (Degree)	Raw Value (dBuV)	Correction Factor (dB/m)
1	5460.00	64.6 PK	74.0	-9.4	2.03 H	117	62.5	2.1
2	5460.00	49.7 AV	54.0	-4.3	2.03 H	117	47.6	2.1
3	#5467.27	66.6 PK	68.2	-1.6	2.03 H	117	64.4	2.2
4	*5530.00	106.4 PK			2.03 H	117	104.4	2.0
5	*5530.00	94.5 AV			2.03 H	117	92.5	2.0
6	#5809.82	51.7 PK	68.2	-16.5	2.03 H	117	49.1	2.6
7	11060.00	50.0 PK	74.0	-24.0	3.68 H	296	37.9	12.1
8	11060.00	37.8 AV	54.0	-16.2	3.68 H	296	25.7	12.1
9	#16590.00	58.5 PK	68.2	-9.7	1.54 H	267	44.2	14.3

Antenna Polarity & Test Distance : Vertical at 3 m

No	Frequency (MHz)	Emission Level (dBuV/m)	Limit (dBuV/m)	Margin (dB)	Antenna Height (m)	Table Angle (Degree)	Raw Value (dBuV)	Correction Factor (dB/m)
1	5455.56	55.2 PK	74.0	-18.8	1.59 V	94	53.1	2.1
2	5455.56	41.2 AV	54.0	-12.8	1.59 V	94	39.1	2.1
3	#5467.50	56.0 PK	68.2	-12.2	1.59 V	94	53.8	2.2
4	*5530.00	97.8 PK			1.59 V	94	95.8	2.0
5	*5530.00	86.4 AV			1.59 V	94	84.4	2.0
6	#5759.62	52.0 PK	68.2	-16.2	1.59 V	94	49.5	2.5
7	11060.00	48.8 PK	74.0	-25.2	2.49 V	318	36.7	12.1
8	11060.00	36.8 AV	54.0	-17.2	2.49 V	318	24.7	12.1
9	#16590.00	58.3 PK	68.2	-9.9	1.45 V	276	44.0	14.3

Remarks:

1. Emission Level(dBuV/m) = Raw Value(dBuV) + Correction Factor(dB/m)
2. Correction Factor(dB/m) = Antenna Factor(dB/m) + Cable Factor(dB) – Pre-Amplifier Factor(dB)
3. Margin value = Emission Level – Limit value
4. The other emission levels were very low against the limit.
5. " * ": Fundamental frequency.
6. " # ": The radiated frequency is out of the restricted band.

RF Mode	TX 802.11ax (HE80)	Channel	CH 122 : 5610 MHz
Frequency Range	1GHz ~ 40GHz	Detector Function	Peak (PK) Average (AV)

Antenna Polarity & Test Distance : Horizontal at 3 m

No	Frequency (MHz)	Emission Level (dBuV/m)	Limit (dBuV/m)	Margin (dB)	Antenna Height (m)	Table Angle (Degree)	Raw Value (dBuV)	Correction Factor (dB/m)
1	*5610.00	108.9 PK			1.93 H	132	106.8	2.1
2	*5610.00	97.8 AV			1.93 H	132	95.7	2.1
3	#5725.00	66.5 PK	68.2	-1.7	1.93 H	132	64.1	2.4
4	11220.00	49.2 PK	74.0	-24.8	3.68 H	298	37.1	12.1
5	11220.00	37.1 AV	54.0	-16.9	3.68 H	298	25.0	12.1
6	#16830.00	59.0 PK	68.2	-9.2	1.53 H	284	43.2	15.8

Antenna Polarity & Test Distance : Vertical at 3 m

No	Frequency (MHz)	Emission Level (dBuV/m)	Limit (dBuV/m)	Margin (dB)	Antenna Height (m)	Table Angle (Degree)	Raw Value (dBuV)	Correction Factor (dB/m)
1	*5610.00	103.1 PK			1.36 V	128	101.0	2.1
2	*5610.00	90.3 AV			1.36 V	128	88.2	2.1
3	#5725.00	57.6 PK	68.2	-10.6	1.36 V	128	55.2	2.4
4	11220.00	48.4 PK	74.0	-25.6	2.58 V	334	36.3	12.1
5	11220.00	36.3 AV	54.0	-17.7	2.58 V	334	24.2	12.1
6	#16830.00	58.3 PK	68.2	-9.9	1.44 V	282	42.5	15.8

Remarks:

1. Emission Level(dBuV/m) = Raw Value(dBuV) + Correction Factor(dB/m)
2. Correction Factor(dB/m) = Antenna Factor(dB/m) + Cable Factor(dB) – Pre-Amplifier Factor(dB)
3. Margin value = Emission Level – Limit value
4. The other emission levels were very low against the limit.
5. " * " : Fundamental frequency.
6. " # " : The radiated frequency is out of the restricted band.

RF Mode	TX 802.11ax (HE80)	Channel	CH 138 : 5690 MHz
Frequency Range	1GHz ~ 40GHz	Detector Function	Peak (PK) Average (AV)

Antenna Polarity & Test Distance : Horizontal at 3 m

No	Frequency (MHz)	Emission Level (dBuV/m)	Limit (dBuV/m)	Margin (dB)	Antenna Height (m)	Table Angle (Degree)	Raw Value (dBuV)	Correction Factor (dB/m)
1	5460.00	56.4 PK	74.0	-17.6	1.93 H	131	54.3	2.1
2	5460.00	40.1 AV	54.0	-13.9	1.93 H	131	38.0	2.1
3	#5470.00	60.0 PK	68.2	-8.2	1.93 H	131	57.8	2.2
4	*5690.00	109.1 PK			1.93 H	131	106.8	2.3
5	*5690.00	98.0 AV			1.93 H	131	95.7	2.3
6	#5850.00	63.4 PK	68.2	-4.8	1.93 H	131	60.7	2.7
7	11380.00	49.8 PK	74.0	-24.2	3.66 H	300	37.4	12.4
8	11380.00	37.9 AV	54.0	-16.1	3.66 H	300	25.5	12.4
9	#17070.00	58.2 PK	68.2	-10.0	1.54 H	267	41.4	16.8

Antenna Polarity & Test Distance : Vertical at 3 m

No	Frequency (MHz)	Emission Level (dBuV/m)	Limit (dBuV/m)	Margin (dB)	Antenna Height (m)	Table Angle (Degree)	Raw Value (dBuV)	Correction Factor (dB/m)
1	5460.00	54.8 PK	74.0	-19.2	1.37 V	122	52.7	2.1
2	5460.00	38.2 AV	54.0	-15.8	1.37 V	122	36.1	2.1
3	#5470.00	57.6 PK	68.2	-10.6	1.37 V	122	55.4	2.2
4	*5690.00	102.8 PK			1.37 V	122	100.5	2.3
5	*5690.00	90.0 AV			1.37 V	122	87.7	2.3
6	#5850.00	59.6 PK	68.2	-8.6	1.37 V	122	56.9	2.7
7	11380.00	49.1 PK	74.0	-24.9	2.54 V	336	36.7	12.4
8	11380.00	37.0 AV	54.0	-17.0	2.54 V	336	24.6	12.4
9	#17070.00	57.9 PK	68.2	-10.3	1.42 V	278	41.1	16.8

Remarks:

1. Emission Level(dBuV/m) = Raw Value(dBuV) + Correction Factor(dB/m)
2. Correction Factor(dB/m) = Antenna Factor(dB/m) + Cable Factor(dB) – Pre-Amplifier Factor(dB)
3. Margin value = Emission Level – Limit value
4. The other emission levels were very low against the limit.
5. " * ": Fundamental frequency.
6. " # ": The radiated frequency is out of the restricted band.

RF Mode	TX 802.11ax (HE80)	Channel	CH 155 : 5775 MHz
Frequency Range	1GHz ~ 40GHz	Detector Function	Peak (PK) Average (AV)

Antenna Polarity & Test Distance : Horizontal at 3 m								
No	Frequency (MHz)	Emission Level (dBuV/m)	Limit (dBuV/m)	Margin (dB)	Antenna Height (m)	Table Angle (Degree)	Raw Value (dBuV)	Correction Factor (dB/m)
1	#5643.50	66.7 PK	68.2	-1.5	1.95 H	131	64.4	2.3
2	*5775.00	110.0 PK			1.95 H	131	107.5	2.5
3	*5775.00	98.9 AV			1.95 H	131	96.4	2.5
4	#5929.25	66.3 PK	68.2	-1.9	1.95 H	131	63.4	2.9
5	11550.00	49.5 PK	74.0	-24.5	3.70 H	309	37.0	12.5
6	11550.00	37.3 AV	54.0	-16.7	3.70 H	309	24.8	12.5
7	#17325.00	59.0 PK	68.2	-9.2	1.55 H	276	41.7	17.3

Antenna Polarity & Test Distance : Vertical at 3 m								
No	Frequency (MHz)	Emission Level (dBuV/m)	Limit (dBuV/m)	Margin (dB)	Antenna Height (m)	Table Angle (Degree)	Raw Value (dBuV)	Correction Factor (dB/m)
1	#5643.16	56.8 PK	68.2	-11.4	1.50 V	104	54.5	2.3
2	*5775.00	102.9 PK			1.50 V	104	100.4	2.5
3	*5775.00	91.6 AV			1.50 V	104	89.1	2.5
4	#5928.06	57.6 PK	68.2	-10.6	1.50 V	104	54.7	2.9
5	11550.00	48.8 PK	74.0	-25.2	2.58 V	327	36.3	12.5
6	11550.00	37.1 AV	54.0	-16.9	2.58 V	327	24.6	12.5
7	#17325.00	58.0 PK	68.2	-10.2	1.48 V	255	40.7	17.3

Remarks:

1. Emission Level(dBuV/m) = Raw Value(dBuV) + Correction Factor(dB/m)
2. Correction Factor(dB/m) = Antenna Factor(dB/m) + Cable Factor(dB) – Pre-Amplifier Factor(dB)
3. Margin value = Emission Level – Limit value
4. The other emission levels were very low against the limit.
5. " * ": Fundamental frequency.
6. " # ": The radiated frequency is out of the restricted band.

RF Mode	TX 20MHz Preamble 802.11ax (RU26)	Channel	CH 36 : 5180 MHz
Frequency Range	1GHz ~ 40GHz	Detector Function	Peak (PK) Average (AV)

Antenna Polarity & Test Distance : Horizontal at 3 m

No	Frequency (MHz)	Emission Level (dBuV/m)	Limit (dBuV/m)	Margin (dB)	Antenna Height (m)	Table Angle (Degree)	Raw Value (dBuV)	Correction Factor (dB/m)
1	5131.70	57.1 PK	74.0	-16.9	2.17 H	106	54.8	2.3
2	5131.70	47.2 AV	54.0	-6.8	2.17 H	106	44.9	2.3
3	5150.00	58.4 PK	74.0	-15.6	2.17 H	106	56.1	2.3
4	5150.00	45.7 AV	54.0	-8.3	2.17 H	106	43.4	2.3
5	*5180.00	122.7 PK			2.17 H	106	120.5	2.2
6	*5180.00	112.0 AV			2.17 H	106	109.8	2.2
7	#10360.00	49.9 PK	68.2	-18.3	2.75 H	353	38.1	11.8
8	15540.00	63.3 PK	74.0	-10.7	1.47 H	276	51.5	11.8
9	15540.00	49.8 AV	54.0	-4.2	1.47 H	276	38.0	11.8

Antenna Polarity & Test Distance : Vertical at 3 m

No	Frequency (MHz)	Emission Level (dBuV/m)	Limit (dBuV/m)	Margin (dB)	Antenna Height (m)	Table Angle (Degree)	Raw Value (dBuV)	Correction Factor (dB/m)
1	5148.80	61.7 PK	74.0	-12.3	1.93 V	120	59.4	2.3
2	5148.80	40.8 AV	54.0	-13.2	1.93 V	120	38.5	2.3
3	*5180.00	116.8 PK			1.93 V	120	114.6	2.2
4	*5180.00	104.9 AV			1.93 V	120	102.7	2.2
5	#10360.00	50.8 PK	68.2	-17.4	2.64 V	218	39.0	11.8
6	15540.00	61.8 PK	74.0	-12.2	1.52 V	288	50.0	11.8
7	15540.00	48.4 AV	54.0	-5.6	1.52 V	288	36.6	11.8

Remarks:

1. Emission Level(dBuV/m) = Raw Value(dBuV) + Correction Factor(dB/m)
2. Correction Factor(dB/m) = Antenna Factor(dB/m) + Cable Factor(dB) – Pre-Amplifier Factor(dB)
3. Margin value = Emission Level – Limit value
4. The other emission levels were very low against the limit.
5. " * ": Fundamental frequency.
6. " # ": The radiated frequency is out of the restricted band.

RF Mode	TX 20MHz Preamble 802.11ax (RU26)	Channel	CH 40 : 5200 MHz
Frequency Range	1GHz ~ 40GHz	Detector Function	Peak (PK) Average (AV)

Antenna Polarity & Test Distance : Horizontal at 3 m

No	Frequency (MHz)	Emission Level (dBuV/m)	Limit (dBuV/m)	Margin (dB)	Antenna Height (m)	Table Angle (Degree)	Raw Value (dBuV)	Correction Factor (dB/m)
1	5150.00	53.2 PK	74.0	-20.8	2.19 H	110	50.9	2.3
2	5150.00	39.3 AV	54.0	-14.7	2.19 H	110	37.0	2.3
3	*5200.00	122.2 PK			2.19 H	110	120.1	2.1
4	*5200.00	111.7 AV			2.19 H	110	109.6	2.1
5	#10400.00	50.5 PK	68.2	-17.7	2.78 H	355	38.5	12.0
6	15600.00	63.3 PK	74.0	-10.7	1.42 H	269	51.8	11.5
7	15600.00	49.9 AV	54.0	-4.1	1.42 H	269	38.4	11.5

Antenna Polarity & Test Distance : Vertical at 3 m

No	Frequency (MHz)	Emission Level (dBuV/m)	Limit (dBuV/m)	Margin (dB)	Antenna Height (m)	Table Angle (Degree)	Raw Value (dBuV)	Correction Factor (dB/m)
1	5150.00	51.9 PK	74.0	-22.1	1.93 V	120	49.6	2.3
2	5150.00	38.2 AV	54.0	-15.8	1.93 V	120	35.9	2.3
3	*5200.00	117.2 PK			1.93 V	120	115.1	2.1
4	*5200.00	105.3 AV			1.93 V	120	103.2	2.1
5	#10400.00	50.8 PK	68.2	-17.4	2.70 V	217	38.8	12.0
6	15600.00	61.3 PK	74.0	-12.7	1.56 V	273	49.8	11.5
7	15600.00	48.2 AV	54.0	-5.8	1.56 V	273	36.7	11.5

Remarks:

1. Emission Level(dBuV/m) = Raw Value(dBuV) + Correction Factor(dB/m)
2. Correction Factor(dB/m) = Antenna Factor(dB/m) + Cable Factor(dB) – Pre-Amplifier Factor(dB)
3. Margin value = Emission Level – Limit value
4. The other emission levels were very low against the limit.
5. " * ": Fundamental frequency.
6. " # ": The radiated frequency is out of the restricted band.

RF Mode	TX 20MHz Preamble 802.11ax (RU26)	Channel	CH 48 : 5240 MHz
Frequency Range	1GHz ~ 40GHz	Detector Function	Peak (PK) Average (AV)

Antenna Polarity & Test Distance : Horizontal at 3 m

No	Frequency (MHz)	Emission Level (dBuV/m)	Limit (dBuV/m)	Margin (dB)	Antenna Height (m)	Table Angle (Degree)	Raw Value (dBuV)	Correction Factor (dB/m)
1	5150.00	53.9 PK	74.0	-20.1	2.14 H	93	51.6	2.3
2	5150.00	39.4 AV	54.0	-14.6	2.14 H	93	37.1	2.3
3	*5240.00	122.3 PK			2.14 H	93	120.3	2.0
4	*5240.00	111.7 AV			2.14 H	93	109.7	2.0
5	5350.00	52.7 PK	74.0	-21.3	2.14 H	93	50.8	1.9
6	5350.00	38.7 AV	54.0	-15.3	2.14 H	93	36.8	1.9
7	#10480.00	50.2 PK	68.2	-18.0	2.69 H	356	38.3	11.9
8	15720.00	63.1 PK	74.0	-10.9	1.53 H	279	51.3	11.8
9	15720.00	49.7 AV	54.0	-4.3	1.53 H	279	37.9	11.8

Antenna Polarity & Test Distance : Vertical at 3 m

No	Frequency (MHz)	Emission Level (dBuV/m)	Limit (dBuV/m)	Margin (dB)	Antenna Height (m)	Table Angle (Degree)	Raw Value (dBuV)	Correction Factor (dB/m)
1	5150.00	51.4 PK	74.0	-22.6	1.88 V	122	49.1	2.3
2	5150.00	37.6 AV	54.0	-16.4	1.88 V	122	35.3	2.3
3	*5240.00	117.3 PK			1.88 V	122	115.3	2.0
4	*5240.00	105.3 AV			1.88 V	122	103.3	2.0
5	5350.00	49.4 PK	74.0	-24.6	1.88 V	122	47.5	1.9
6	5350.00	37.8 AV	54.0	-16.2	1.88 V	122	35.9	1.9
7	#10480.00	50.7 PK	68.2	-17.5	2.69 V	208	38.8	11.9
8	15720.00	61.2 PK	74.0	-12.8	1.52 V	276	49.4	11.8
9	15720.00	48.0 AV	54.0	-6.0	1.52 V	276	36.2	11.8

Remarks:

1. Emission Level(dBuV/m) = Raw Value(dBuV) + Correction Factor(dB/m)
2. Correction Factor(dB/m) = Antenna Factor(dB/m) + Cable Factor(dB) – Pre-Amplifier Factor(dB)
3. Margin value = Emission Level – Limit value
4. The other emission levels were very low against the limit.
5. " * ": Fundamental frequency.
6. " # ": The radiated frequency is out of the restricted band.

RF Mode	TX 20MHz Preamble 802.11ax (RU26)	Channel	CH 52 : 5260 MHz
Frequency Range	1GHz ~ 40GHz	Detector Function	Peak (PK) Average (AV)

Antenna Polarity & Test Distance : Horizontal at 3 m

No	Frequency (MHz)	Emission Level (dBuV/m)	Limit (dBuV/m)	Margin (dB)	Antenna Height (m)	Table Angle (Degree)	Raw Value (dBuV)	Correction Factor (dB/m)
1	5150.00	54.0 PK	74.0	-20.0	2.18 H	106	51.7	2.3
2	5150.00	39.5 AV	54.0	-14.5	2.18 H	106	37.2	2.3
3	*5260.00	123.1 PK			2.18 H	106	121.1	2.0
4	*5260.00	112.3 AV			2.18 H	106	110.3	2.0
5	5350.00	52.7 PK	74.0	-21.3	2.18 H	106	50.8	1.9
6	5350.00	38.8 AV	54.0	-15.2	2.18 H	106	36.9	1.9
7	#10520.00	49.9 PK	68.2	-18.3	2.75 H	348	37.9	12.0
8	15780.00	62.9 PK	74.0	-11.1	1.43 H	278	51.4	11.5
9	15780.00	49.4 AV	54.0	-4.6	1.43 H	278	37.9	11.5

Antenna Polarity & Test Distance : Vertical at 3 m

No	Frequency (MHz)	Emission Level (dBuV/m)	Limit (dBuV/m)	Margin (dB)	Antenna Height (m)	Table Angle (Degree)	Raw Value (dBuV)	Correction Factor (dB/m)
1	5150.00	51.0 PK	74.0	-23.0	1.94 V	115	48.7	2.3
2	5150.00	37.3 AV	54.0	-16.7	1.94 V	115	35.0	2.3
3	*5260.00	116.6 PK			1.94 V	115	114.6	2.0
4	*5260.00	104.7 AV			1.94 V	115	102.7	2.0
5	5350.00	50.1 PK	74.0	-23.9	1.94 V	115	48.2	1.9
6	5350.00	38.5 AV	54.0	-15.5	1.94 V	115	36.6	1.9
7	#10520.00	51.1 PK	68.2	-17.1	2.60 V	229	39.1	12.0
8	15780.00	61.6 PK	74.0	-12.4	1.49 V	282	50.1	11.5
9	15780.00	48.2 AV	54.0	-5.8	1.49 V	282	36.7	11.5

Remarks:

1. Emission Level(dBuV/m) = Raw Value(dBuV) + Correction Factor(dB/m)
2. Correction Factor(dB/m) = Antenna Factor(dB/m) + Cable Factor(dB) – Pre-Amplifier Factor(dB)
3. Margin value = Emission Level – Limit value
4. The other emission levels were very low against the limit.
5. " * ": Fundamental frequency.
6. " # ": The radiated frequency is out of the restricted band.

RF Mode	TX 20MHz Preamble 802.11ax (RU26)	Channel	CH 60 : 5300 MHz
Frequency Range	1GHz ~ 40GHz	Detector Function	Peak (PK) Average (AV)

Antenna Polarity & Test Distance : Horizontal at 3 m

No	Frequency (MHz)	Emission Level (dBuV/m)	Limit (dBuV/m)	Margin (dB)	Antenna Height (m)	Table Angle (Degree)	Raw Value (dBuV)	Correction Factor (dB/m)
1	*5300.00	123.0 PK			2.23 H	90	121.3	1.7
2	*5300.00	112.4 AV			2.23 H	90	110.7	1.7
3	5350.00	53.5 PK	74.0	-20.5	2.23 H	90	51.6	1.9
4	5350.00	39.6 AV	54.0	-14.4	2.23 H	90	37.7	1.9
5	10600.00	49.4 PK	74.0	-24.6	2.70 H	342	37.5	11.9
6	10600.00	38.7 AV	54.0	-15.3	2.70 H	342	26.8	11.9
7	15900.00	63.7 PK	74.0	-10.3	1.52 H	277	52.4	11.3
8	15900.00	50.3 AV	54.0	-3.7	1.52 H	277	39.0	11.3

Antenna Polarity & Test Distance : Vertical at 3 m

No	Frequency (MHz)	Emission Level (dBuV/m)	Limit (dBuV/m)	Margin (dB)	Antenna Height (m)	Table Angle (Degree)	Raw Value (dBuV)	Correction Factor (dB/m)
1	*5300.00	117.2 PK			1.89 V	123	115.5	1.7
2	*5300.00	105.2 AV			1.89 V	123	103.5	1.7
3	5350.00	52.3 PK	74.0	-21.7	1.89 V	123	50.4	1.9
4	5350.00	38.2 AV	54.0	-15.8	1.89 V	123	36.3	1.9
5	10600.00	51.0 PK	74.0	-23.0	2.61 V	212	39.1	11.9
6	10600.00	39.4 AV	54.0	-14.6	2.61 V	212	27.5	11.9
7	15900.00	61.9 PK	74.0	-12.1	1.51 V	303	50.6	11.3
8	15900.00	48.8 AV	54.0	-5.2	1.51 V	303	37.5	11.3

Remarks:

1. Emission Level(dBuV/m) = Raw Value(dBuV) + Correction Factor(dB/m)
2. Correction Factor(dB/m) = Antenna Factor(dB/m) + Cable Factor(dB) – Pre-Amplifier Factor(dB)
3. Margin value = Emission Level – Limit value
4. The other emission levels were very low against the limit.
5. " * ": Fundamental frequency.

RF Mode	TX 20MHz Preamble 802.11ax (RU26)	Channel	CH 64 : 5320 MHz
Frequency Range	1GHz ~ 40GHz	Detector Function	Peak (PK) Average (AV)

Antenna Polarity & Test Distance : Horizontal at 3 m

No	Frequency (MHz)	Emission Level (dBuV/m)	Limit (dBuV/m)	Margin (dB)	Antenna Height (m)	Table Angle (Degree)	Raw Value (dBuV)	Correction Factor (dB/m)
1	*5320.00	122.9 PK			2.10 H	100	121.1	1.8
2	*5320.00	112.3 AV			2.10 H	100	110.5	1.8
3	5350.06	60.0 PK	74.0	-14.0	2.10 H	100	58.1	1.9
4	5350.06	44.1 AV	54.0	-9.9	2.10 H	100	42.2	1.9
5	5356.15	69.1 PK	74.0	-4.9	2.10 H	100	67.1	2.0
6	5356.15	43.0 AV	54.0	-11.0	2.10 H	100	41.0	2.0
7	10640.00	50.2 PK	74.0	-23.8	2.78 H	349	38.4	11.8
8	10640.00	39.4 AV	54.0	-14.6	2.78 H	349	27.6	11.8
9	15960.00	62.9 PK	74.0	-11.1	1.43 H	287	51.3	11.6
10	15960.00	49.5 AV	54.0	-4.5	1.43 H	287	37.9	11.6

Antenna Polarity & Test Distance : Vertical at 3 m

No	Frequency (MHz)	Emission Level (dBuV/m)	Limit (dBuV/m)	Margin (dB)	Antenna Height (m)	Table Angle (Degree)	Raw Value (dBuV)	Correction Factor (dB/m)
1	*5320.00	116.4 PK			1.90 V	118	114.6	1.8
2	*5320.00	104.6 AV			1.90 V	118	102.8	1.8
3	5363.40	61.0 PK	74.0	-13.0	1.90 V	118	59.0	2.0
4	5363.40	38.6 AV	54.0	-15.4	1.90 V	118	36.6	2.0
5	5368.70	49.7 PK	74.0	-24.3	1.90 V	118	47.7	2.0
6	5368.70	39.9 AV	54.0	-14.1	1.90 V	118	37.9	2.0
7	10640.00	50.8 PK	74.0	-23.2	2.61 V	228	39.0	11.8
8	10640.00	39.3 AV	54.0	-14.7	2.61 V	228	27.5	11.8
9	15960.00	61.6 PK	74.0	-12.4	1.57 V	296	50.0	11.6
10	15960.00	48.3 AV	54.0	-5.7	1.57 V	296	36.7	11.6

Remarks:

1. Emission Level(dBuV/m) = Raw Value(dBuV) + Correction Factor(dB/m)
2. Correction Factor(dB/m) = Antenna Factor(dB/m) + Cable Factor(dB) – Pre-Amplifier Factor(dB)
3. Margin value = Emission Level – Limit value
4. The other emission levels were very low against the limit.
5. " * ": Fundamental frequency.

RF Mode	TX 20MHz Preamble 802.11ax (RU26)	Channel	CH 100 : 5500 MHz
Frequency Range	1GHz ~ 40GHz	Detector Function	Peak (PK) Average (AV)

Antenna Polarity & Test Distance : Horizontal at 3 m

No	Frequency (MHz)	Emission Level (dBuV/m)	Limit (dBuV/m)	Margin (dB)	Antenna Height (m)	Table Angle (Degree)	Raw Value (dBuV)	Correction Factor (dB/m)
1	5451.70	58.5 PK	74.0	-15.5	2.13 H	113	56.4	2.1
2	5451.70	45.5 AV	54.0	-8.5	2.13 H	113	43.4	2.1
3	5458.80	68.0 PK	74.0	-6.0	2.13 H	113	65.9	2.1
4	5458.80	42.1 AV	54.0	-11.9	2.13 H	113	40.0	2.1
5	#5465.40	61.7 PK	68.2	-6.5	2.13 H	113	59.6	2.1
6	*5500.00	123.1 PK			2.13 H	113	121.0	2.1
7	*5500.00	112.3 AV			2.13 H	113	110.2	2.1
8	11000.00	49.8 PK	74.0	-24.2	2.71 H	349	37.4	12.4
9	11000.00	38.8 AV	54.0	-15.2	2.71 H	349	26.4	12.4
10	#16500.00	62.8 PK	68.2	-5.4	1.43 H	271	49.1	13.7

Antenna Polarity & Test Distance : Vertical at 3 m

No	Frequency (MHz)	Emission Level (dBuV/m)	Limit (dBuV/m)	Margin (dB)	Antenna Height (m)	Table Angle (Degree)	Raw Value (dBuV)	Correction Factor (dB/m)
1	5456.74	58.8 PK	74.0	-15.2	1.83 V	132	56.7	2.1
2	5456.74	38.5 AV	54.0	-15.5	1.83 V	132	36.4	2.1
3	#5466.70	61.2 PK	68.2	-7.0	1.83 V	132	59.0	2.2
4	*5500.00	114.8 PK			1.83 V	132	112.7	2.1
5	*5500.00	103.9 AV			1.83 V	132	101.8	2.1
6	11000.00	50.4 PK	74.0	-23.6	2.70 V	223	38.0	12.4
7	11000.00	39.4 AV	54.0	-14.6	2.70 V	223	27.0	12.4
8	#16500.00	61.7 PK	68.2	-6.5	1.54 V	291	48.0	13.7

Remarks:

1. Emission Level(dBuV/m) = Raw Value(dBuV) + Correction Factor(dB/m)
2. Correction Factor(dB/m) = Antenna Factor(dB/m) + Cable Factor(dB) – Pre-Amplifier Factor(dB)
3. Margin value = Emission Level – Limit value
4. The other emission levels were very low against the limit.
5. " * ": Fundamental frequency.
6. " # ": The radiated frequency is out of the restricted band.

RF Mode	TX 20MHz Preamble 802.11ax (RU26)	Channel	CH 116 : 5580 MHz
Frequency Range	1GHz ~ 40GHz	Detector Function	Peak (PK) Average (AV)

Antenna Polarity & Test Distance : Horizontal at 3 m

No	Frequency (MHz)	Emission Level (dBuV/m)	Limit (dBuV/m)	Margin (dB)	Antenna Height (m)	Table Angle (Degree)	Raw Value (dBuV)	Correction Factor (dB/m)
1	*5580.00	122.2 PK			2.22 H	115	120.1	2.1
2	*5580.00	112.4 AV			2.22 H	115	110.3	2.1
3	11160.00	49.6 PK	74.0	-24.4	2.78 H	350	37.6	12.0
4	11160.00	39.0 AV	54.0	-15.0	2.78 H	350	27.0	12.0
5	#16740.00	63.4 PK	68.2	-4.8	1.45 H	270	48.1	15.3

Antenna Polarity & Test Distance : Vertical at 3 m

No	Frequency (MHz)	Emission Level (dBuV/m)	Limit (dBuV/m)	Margin (dB)	Antenna Height (m)	Table Angle (Degree)	Raw Value (dBuV)	Correction Factor (dB/m)
1	*5580.00	117.5 PK			1.91 V	131	115.4	2.1
2	*5580.00	105.3 AV			1.91 V	131	103.2	2.1
3	11160.00	51.1 PK	74.0	-22.9	2.66 V	205	39.1	12.0
4	11160.00	39.8 AV	54.0	-14.2	2.66 V	205	27.8	12.0
5	#16740.00	61.7 PK	68.2	-6.5	1.47 V	285	46.4	15.3

Remarks:

1. Emission Level(dBuV/m) = Raw Value(dBuV) + Correction Factor(dB/m)
2. Correction Factor(dB/m) = Antenna Factor(dB/m) + Cable Factor(dB) – Pre-Amplifier Factor(dB)
3. Margin value = Emission Level – Limit value
4. The other emission levels were very low against the limit.
5. " * " : Fundamental frequency.
6. " # " : The radiated frequency is out of the restricted band.

RF Mode	TX 20MHz Preamble 802.11ax (RU26)	Channel	CH 140 : 5700 MHz
Frequency Range	1GHz ~ 40GHz	Detector Function	Peak (PK) Average (AV)

Antenna Polarity & Test Distance : Horizontal at 3 m

No	Frequency (MHz)	Emission Level (dBuV/m)	Limit (dBuV/m)	Margin (dB)	Antenna Height (m)	Table Angle (Degree)	Raw Value (dBuV)	Correction Factor (dB/m)
1	*5700.00	120.8 PK			1.96 H	115	118.5	2.3
2	*5700.00	110.1 AV			1.96 H	115	107.8	2.3
3	#5725.00	66.5 PK	68.2	-1.7	1.96 H	115	64.1	2.4
4	11400.00	49.5 PK	74.0	-24.5	2.72 H	359	37.0	12.5
5	11400.00	38.7 AV	54.0	-15.3	2.72 H	359	26.2	12.5
6	#17100.00	63.1 PK	68.2	-5.1	1.51 H	267	46.3	16.8

Antenna Polarity & Test Distance : Vertical at 3 m

No	Frequency (MHz)	Emission Level (dBuV/m)	Limit (dBuV/m)	Margin (dB)	Antenna Height (m)	Table Angle (Degree)	Raw Value (dBuV)	Correction Factor (dB/m)
1	*5700.00	114.4 PK			1.81 V	121	112.1	2.3
2	*5700.00	103.4 AV			1.81 V	121	101.1	2.3
3	#5725.00	57.9 PK	68.2	-10.3	1.81 V	121	55.5	2.4
4	11400.00	51.1 PK	74.0	-22.9	2.69 V	212	38.6	12.5
5	11400.00	39.9 AV	54.0	-14.1	2.69 V	212	27.4	12.5
6	#17100.00	62.3 PK	68.2	-5.9	1.55 V	275	45.5	16.8

Remarks:

1. Emission Level(dBuV/m) = Raw Value(dBuV) + Correction Factor(dB/m)
2. Correction Factor(dB/m) = Antenna Factor(dB/m) + Cable Factor(dB) – Pre-Amplifier Factor(dB)
3. Margin value = Emission Level – Limit value
4. The other emission levels were very low against the limit.
5. " * ": Fundamental frequency.
6. " # ": The radiated frequency is out of the restricted band.

RF Mode	TX 20MHz Preamble 802.11ax (RU26)	Channel	CH 144 : 5720 MHz
Frequency Range	1GHz ~ 40GHz	Detector Function	Peak (PK) Average (AV)

Antenna Polarity & Test Distance : Horizontal at 3 m

No	Frequency (MHz)	Emission Level (dBuV/m)	Limit (dBuV/m)	Margin (dB)	Antenna Height (m)	Table Angle (Degree)	Raw Value (dBuV)	Correction Factor (dB/m)
1	5460.00	52.7 PK	74.0	-21.3	2.19 H	109	50.6	2.1
2	5460.00	38.9 AV	54.0	-15.1	2.19 H	109	36.8	2.1
3	#5470.00	53.3 PK	68.2	-14.9	2.19 H	109	51.1	2.2
4	*5720.00	122.3 PK			2.19 H	109	119.9	2.4
5	*5720.00	111.5 AV			2.19 H	109	109.1	2.4
6	#5850.00	52.2 PK	68.2	-16.0	2.19 H	109	49.5	2.7
7	11440.00	49.6 PK	74.0	-24.4	2.74 H	351	37.2	12.4
8	11440.00	38.8 AV	54.0	-15.2	2.74 H	351	26.4	12.4
9	#17160.00	63.5 PK	68.2	-4.7	1.50 H	289	46.9	16.6

Antenna Polarity & Test Distance : Vertical at 3 m

No	Frequency (MHz)	Emission Level (dBuV/m)	Limit (dBuV/m)	Margin (dB)	Antenna Height (m)	Table Angle (Degree)	Raw Value (dBuV)	Correction Factor (dB/m)
1	5460.00	51.6 PK	74.0	-22.4	1.91 V	107	49.5	2.1
2	5460.00	38.3 AV	54.0	-15.7	1.91 V	107	36.2	2.1
3	#5470.00	50.1 PK	68.2	-18.1	1.91 V	107	47.9	2.2
4	*5720.00	117.0 PK			1.91 V	107	114.6	2.4
5	*5720.00	105.3 AV			1.91 V	107	102.9	2.4
6	#5850.00	51.2 PK	68.2	-17.0	1.91 V	107	48.5	2.7
7	11440.00	50.7 PK	74.0	-23.3	2.68 V	211	38.3	12.4
8	11440.00	39.7 AV	54.0	-14.3	2.68 V	211	27.3	12.4
9	#17160.00	61.9 PK	68.2	-6.3	1.53 V	293	45.3	16.6

Remarks:

1. Emission Level(dBuV/m) = Raw Value(dBuV) + Correction Factor(dB/m)
2. Correction Factor(dB/m) = Antenna Factor(dB/m) + Cable Factor(dB) – Pre-Amplifier Factor(dB)
3. Margin value = Emission Level – Limit value
4. The other emission levels were very low against the limit.
5. " * ": Fundamental frequency.
6. " # ": The radiated frequency is out of the restricted band.

RF Mode	TX 20MHz Preamble 802.11ax (RU26)	Channel	CH 149 : 5745 MHz
Frequency Range	1GHz ~ 40GHz	Detector Function	Peak (PK) Average (AV)

Antenna Polarity & Test Distance : Horizontal at 3 m

No	Frequency (MHz)	Emission Level (dBuV/m)	Limit (dBuV/m)	Margin (dB)	Antenna Height (m)	Table Angle (Degree)	Raw Value (dBuV)	Correction Factor (dB/m)
1	#5614.78	53.3 PK	68.2	-14.9	2.05 H	111	51.2	2.1
2	*5745.00	124.6 PK			2.05 H	111	122.2	2.4
3	*5745.00	114.4 AV			2.05 H	111	112.0	2.4
4	#5951.91	51.8 PK	68.2	-16.4	2.05 H	111	48.9	2.9
5	11490.00	49.4 PK	74.0	-24.6	2.70 H	342	36.8	12.6
6	11490.00	38.7 AV	54.0	-15.3	2.70 H	342	26.1	12.6
7	#17235.00	63.5 PK	68.2	-4.7	1.50 H	291	46.7	16.8

Antenna Polarity & Test Distance : Vertical at 3 m

No	Frequency (MHz)	Emission Level (dBuV/m)	Limit (dBuV/m)	Margin (dB)	Antenna Height (m)	Table Angle (Degree)	Raw Value (dBuV)	Correction Factor (dB/m)
1	#5567.24	50.2 PK	68.2	-18.0	2.08 V	130	48.1	2.1
2	*5745.00	117.0 PK			2.08 V	130	114.6	2.4
3	*5745.00	106.8 AV			2.08 V	130	104.4	2.4
4	#5959.39	51.2 PK	68.2	-17.0	2.08 V	130	48.3	2.9
5	11490.00	50.9 PK	74.0	-23.1	2.61 V	228	38.3	12.6
6	11490.00	39.6 AV	54.0	-14.4	2.61 V	228	27.0	12.6
7	#17235.00	61.8 PK	68.2	-6.4	1.58 V	273	45.0	16.8

Remarks:

1. Emission Level(dBuV/m) = Raw Value(dBuV) + Correction Factor(dB/m)
2. Correction Factor(dB/m) = Antenna Factor(dB/m) + Cable Factor(dB) – Pre-Amplifier Factor(dB)
3. Margin value = Emission Level – Limit value
4. The other emission levels were very low against the limit.
5. " * ": Fundamental frequency.
6. " # ": The radiated frequency is out of the restricted band.

RF Mode	TX 20MHz Preamble 802.11ax (RU26)	Channel	CH 157 : 5785 MHz
Frequency Range	1GHz ~ 40GHz	Detector Function	Peak (PK) Average (AV)

Antenna Polarity & Test Distance : Horizontal at 3 m

No	Frequency (MHz)	Emission Level (dBuV/m)	Limit (dBuV/m)	Margin (dB)	Antenna Height (m)	Table Angle (Degree)	Raw Value (dBuV)	Correction Factor (dB/m)
1	#5552.79	53.1 PK	68.2	-15.1	2.07 H	113	51.0	2.1
2	*5785.00	124.1 PK			2.07 H	113	121.5	2.6
3	*5785.00	114.3 AV			2.07 H	113	111.7	2.6
4	#5994.66	50.7 PK	68.2	-17.5	2.07 H	113	47.8	2.9
5	11570.00	49.9 PK	74.0	-24.1	2.70 H	340	37.3	12.6
6	11570.00	39.0 AV	54.0	-15.0	2.70 H	340	26.4	12.6
7	#17355.00	63.6 PK	68.2	-4.6	1.52 H	280	45.9	17.7

Antenna Polarity & Test Distance : Vertical at 3 m

No	Frequency (MHz)	Emission Level (dBuV/m)	Limit (dBuV/m)	Margin (dB)	Antenna Height (m)	Table Angle (Degree)	Raw Value (dBuV)	Correction Factor (dB/m)
1	#5555.65	51.1 PK	68.2	-17.1	2.05 V	132	49.0	2.1
2	*5785.00	117.3 PK			2.05 V	132	114.7	2.6
3	*5785.00	107.0 AV			2.05 V	132	104.4	2.6
4	#5935.31	50.5 PK	68.2	-17.7	2.05 V	132	47.6	2.9
5	11570.00	50.5 PK	74.0	-23.5	2.67 V	236	37.9	12.6
6	11570.00	39.3 AV	54.0	-14.7	2.67 V	236	26.7	12.6
7	#17355.00	63.7 PK	68.2	-4.5	1.50 V	275	46.0	17.7

Remarks:

1. Emission Level(dBuV/m) = Raw Value(dBuV) + Correction Factor(dB/m)
2. Correction Factor(dB/m) = Antenna Factor(dB/m) + Cable Factor(dB) – Pre-Amplifier Factor(dB)
3. Margin value = Emission Level – Limit value
4. The other emission levels were very low against the limit.
5. " * ": Fundamental frequency.
6. " # ": The radiated frequency is out of the restricted band.

RF Mode	TX 20MHz Preamble 802.11ax (RU26)	Channel	CH 165 : 5825 MHz
Frequency Range	1GHz ~ 40GHz	Detector Function	Peak (PK) Average (AV)

Antenna Polarity & Test Distance : Horizontal at 3 m

No	Frequency (MHz)	Emission Level (dBuV/m)	Limit (dBuV/m)	Margin (dB)	Antenna Height (m)	Table Angle (Degree)	Raw Value (dBuV)	Correction Factor (dB/m)
1	#5574.21	52.7 PK	68.2	-15.5	1.99 H	108	50.6	2.1
2	*5825.00	125.0 PK			1.99 H	108	122.4	2.6
3	*5825.00	114.9 AV			1.99 H	108	112.3	2.6
4	#5967.35	51.1 PK	68.2	-17.1	1.99 H	108	48.2	2.9
5	11650.00	50.1 PK	74.0	-23.9	2.78 H	351	37.9	12.2
6	11650.00	39.2 AV	54.0	-14.8	2.78 H	351	27.0	12.2
7	#17475.00	63.6 PK	68.2	-4.6	1.44 H	276	44.9	18.7

Antenna Polarity & Test Distance : Vertical at 3 m

No	Frequency (MHz)	Emission Level (dBuV/m)	Limit (dBuV/m)	Margin (dB)	Antenna Height (m)	Table Angle (Degree)	Raw Value (dBuV)	Correction Factor (dB/m)
1	#5637.72	50.4 PK	68.2	-17.8	2.06 V	126	48.1	2.3
2	*5825.00	116.8 PK			2.06 V	126	114.2	2.6
3	*5825.00	106.6 AV			2.06 V	126	104.0	2.6
4	#5990.80	51.7 PK	68.2	-16.5	2.06 V	126	48.8	2.9
5	11650.00	50.4 PK	74.0	-23.6	2.63 V	229	38.2	12.2
6	11650.00	39.0 AV	54.0	-15.0	2.63 V	229	26.8	12.2
7	#17475.00	61.7 PK	68.2	-6.5	1.51 V	283	43.0	18.7

Remarks:

1. Emission Level(dBuV/m) = Raw Value(dBuV) + Correction Factor(dB/m)
2. Correction Factor(dB/m) = Antenna Factor(dB/m) + Cable Factor(dB) – Pre-Amplifier Factor(dB)
3. Margin value = Emission Level – Limit value
4. The other emission levels were very low against the limit.
5. " * ": Fundamental frequency.
6. " # ": The radiated frequency is out of the restricted band.

RF Mode	TX 20MHz Preamble 802.11ax (RU52)	Channel	CH 36 : 5180 MHz
Frequency Range	1GHz ~ 40GHz	Detector Function	Peak (PK) Average (AV)

Antenna Polarity & Test Distance : Horizontal at 3 m

No	Frequency (MHz)	Emission Level (dBuV/m)	Limit (dBuV/m)	Margin (dB)	Antenna Height (m)	Table Angle (Degree)	Raw Value (dBuV)	Correction Factor (dB/m)
1	5148.90	66.4 PK	74.0	-7.6	2.01 H	107	64.1	2.3
2	5148.90	47.5 AV	54.0	-6.5	2.01 H	107	45.2	2.3
3	*5180.00	121.5 PK			2.01 H	107	119.3	2.2
4	*5180.00	110.6 AV			2.01 H	107	108.4	2.2
5	#10360.00	49.4 PK	68.2	-18.8	1.53 H	335	37.6	11.8
6	15540.00	61.9 PK	74.0	-12.1	1.32 H	286	50.1	11.8
7	15540.00	47.8 AV	54.0	-6.2	1.32 H	286	36.0	11.8

Antenna Polarity & Test Distance : Vertical at 3 m

No	Frequency (MHz)	Emission Level (dBuV/m)	Limit (dBuV/m)	Margin (dB)	Antenna Height (m)	Table Angle (Degree)	Raw Value (dBuV)	Correction Factor (dB/m)
1	5145.00	61.8 PK	74.0	-12.2	1.81 V	118	59.5	2.3
2	5145.00	42.0 AV	54.0	-12.0	1.81 V	118	39.7	2.3
3	*5180.00	114.2 PK			1.81 V	118	112.0	2.2
4	*5180.00	103.7 AV			1.81 V	118	101.5	2.2
5	#10360.00	50.5 PK	68.2	-17.7	2.74 V	258	38.7	11.8
6	15540.00	60.5 PK	74.0	-13.5	1.46 V	267	48.7	11.8
7	15540.00	46.8 AV	54.0	-7.2	1.46 V	267	35.0	11.8

Remarks:

1. Emission Level(dBuV/m) = Raw Value(dBuV) + Correction Factor(dB/m)
2. Correction Factor(dB/m) = Antenna Factor(dB/m) + Cable Factor(dB) – Pre-Amplifier Factor(dB)
3. Margin value = Emission Level – Limit value
4. The other emission levels were very low against the limit.
5. " * ": Fundamental frequency.
6. " # ": The radiated frequency is out of the restricted band.

RF Mode	TX 20MHz Preamble 802.11ax (RU52)	Channel	CH 40 : 5200 MHz
Frequency Range	1GHz ~ 40GHz	Detector Function	Peak (PK) Average (AV)

Antenna Polarity & Test Distance : Horizontal at 3 m

No	Frequency (MHz)	Emission Level (dBuV/m)	Limit (dBuV/m)	Margin (dB)	Antenna Height (m)	Table Angle (Degree)	Raw Value (dBuV)	Correction Factor (dB/m)
1	5150.00	54.2 PK	74.0	-19.8	2.04 H	117	51.9	2.3
2	5150.00	39.6 AV	54.0	-14.4	2.04 H	117	37.3	2.3
3	*5200.00	121.5 PK			2.04 H	117	119.4	2.1
4	*5200.00	110.5 AV			2.04 H	117	108.4	2.1
5	#10400.00	50.0 PK	68.2	-18.2	1.51 H	342	38.0	12.0
6	15600.00	62.3 PK	74.0	-11.7	1.32 H	295	50.8	11.5
7	15600.00	48.1 AV	54.0	-5.9	1.32 H	295	36.6	11.5

Antenna Polarity & Test Distance : Vertical at 3 m

No	Frequency (MHz)	Emission Level (dBuV/m)	Limit (dBuV/m)	Margin (dB)	Antenna Height (m)	Table Angle (Degree)	Raw Value (dBuV)	Correction Factor (dB/m)
1	5150.00	51.9 PK	74.0	-22.1	1.79 V	112	49.6	2.3
2	5150.00	37.9 AV	54.0	-16.1	1.79 V	112	35.6	2.3
3	*5200.00	115.0 PK			1.79 V	112	112.9	2.1
4	*5200.00	104.2 AV			1.79 V	112	102.1	2.1
5	#10400.00	50.7 PK	68.2	-17.5	2.79 V	253	38.7	12.0
6	15600.00	59.9 PK	74.0	-14.1	1.41 V	280	48.4	11.5
7	15600.00	46.4 AV	54.0	-7.6	1.41 V	280	34.9	11.5

Remarks:

1. Emission Level(dBuV/m) = Raw Value(dBuV) + Correction Factor(dB/m)
2. Correction Factor(dB/m) = Antenna Factor(dB/m) + Cable Factor(dB) – Pre-Amplifier Factor(dB)
3. Margin value = Emission Level – Limit value
4. The other emission levels were very low against the limit.
5. " * ": Fundamental frequency.
6. " # ": The radiated frequency is out of the restricted band.

RF Mode	TX 20MHz Preamble 802.11ax (RU52)	Channel	CH 48 : 5240 MHz
Frequency Range	1GHz ~ 40GHz	Detector Function	Peak (PK) Average (AV)

Antenna Polarity & Test Distance : Horizontal at 3 m

No	Frequency (MHz)	Emission Level (dBuV/m)	Limit (dBuV/m)	Margin (dB)	Antenna Height (m)	Table Angle (Degree)	Raw Value (dBuV)	Correction Factor (dB/m)
1	5150.00	53.9 PK	74.0	-20.1	1.96 H	96	51.6	2.3
2	5150.00	39.7 AV	54.0	-14.3	1.96 H	96	37.4	2.3
3	*5240.00	121.9 PK			1.96 H	96	119.9	2.0
4	*5240.00	110.8 AV			1.96 H	96	108.8	2.0
5	5350.00	53.0 PK	74.0	-21.0	1.96 H	96	51.1	1.9
6	5350.00	39.2 AV	54.0	-14.8	1.96 H	96	37.3	1.9
7	#10480.00	50.0 PK	68.2	-18.2	1.55 H	336	38.1	11.9
8	15720.00	62.2 PK	74.0	-11.8	1.27 H	290	50.4	11.8
9	15720.00	48.3 AV	54.0	-5.7	1.27 H	290	36.5	11.8

Antenna Polarity & Test Distance : Vertical at 3 m

No	Frequency (MHz)	Emission Level (dBuV/m)	Limit (dBuV/m)	Margin (dB)	Antenna Height (m)	Table Angle (Degree)	Raw Value (dBuV)	Correction Factor (dB/m)
1	5150.00	51.0 PK	74.0	-23.0	1.78 V	129	48.7	2.3
2	5150.00	37.5 AV	54.0	-16.5	1.78 V	129	35.2	2.3
3	*5240.00	113.9 PK			1.78 V	129	111.9	2.0
4	*5240.00	103.5 AV			1.78 V	129	101.5	2.0
5	5350.00	48.7 PK	74.0	-25.3	1.78 V	129	46.8	1.9
6	5350.00	37.3 AV	54.0	-16.7	1.78 V	129	35.4	1.9
7	#10480.00	50.3 PK	68.2	-17.9	2.73 V	258	38.4	11.9
8	15720.00	60.2 PK	74.0	-13.8	1.44 V	252	48.4	11.8
9	15720.00	46.5 AV	54.0	-7.5	1.44 V	252	34.7	11.8

Remarks:

1. Emission Level(dBuV/m) = Raw Value(dBuV) + Correction Factor(dB/m)
2. Correction Factor(dB/m) = Antenna Factor(dB/m) + Cable Factor(dB) – Pre-Amplifier Factor(dB)
3. Margin value = Emission Level – Limit value
4. The other emission levels were very low against the limit.
5. " * ": Fundamental frequency.
6. " # ": The radiated frequency is out of the restricted band.

RF Mode	TX 20MHz Preamble 802.11ax (RU52)	Channel	CH 52 : 5260 MHz
Frequency Range	1GHz ~ 40GHz	Detector Function	Peak (PK) Average (AV)

Antenna Polarity & Test Distance : Horizontal at 3 m

No	Frequency (MHz)	Emission Level (dBuV/m)	Limit (dBuV/m)	Margin (dB)	Antenna Height (m)	Table Angle (Degree)	Raw Value (dBuV)	Correction Factor (dB/m)
1	5150.00	53.8 PK	74.0	-20.2	2.05 H	117	51.5	2.3
2	5150.00	39.5 AV	54.0	-14.5	2.05 H	117	37.2	2.3
3	*5260.00	120.8 PK			2.05 H	117	118.8	2.0
4	*5260.00	110.2 AV			2.05 H	117	108.2	2.0
5	5350.00	52.4 PK	74.0	-21.6	2.05 H	117	50.5	1.9
6	5350.00	38.6 AV	54.0	-15.4	2.05 H	117	36.7	1.9
7	#10520.00	50.0 PK	68.2	-18.2	1.57 H	339	38.0	12.0
8	15780.00	61.9 PK	74.0	-12.1	1.32 H	295	50.4	11.5
9	15780.00	48.0 AV	54.0	-6.0	1.32 H	295	36.5	11.5

Antenna Polarity & Test Distance : Vertical at 3 m

No	Frequency (MHz)	Emission Level (dBuV/m)	Limit (dBuV/m)	Margin (dB)	Antenna Height (m)	Table Angle (Degree)	Raw Value (dBuV)	Correction Factor (dB/m)
1	5150.00	51.1 PK	74.0	-22.9	1.79 V	118	48.8	2.3
2	5150.00	37.3 AV	54.0	-16.7	1.79 V	118	35.0	2.3
3	*5260.00	114.4 PK			1.79 V	118	112.4	2.0
4	*5260.00	104.1 AV			1.79 V	118	102.1	2.0
5	5350.00	48.8 PK	74.0	-25.2	1.79 V	118	46.9	1.9
6	5350.00	37.4 AV	54.0	-16.6	1.79 V	118	35.5	1.9
7	#10520.00	50.7 PK	68.2	-17.5	2.71 V	258	38.7	12.0
8	15780.00	60.9 PK	74.0	-13.1	1.44 V	277	49.4	11.5
9	15780.00	47.2 AV	54.0	-6.8	1.44 V	277	35.7	11.5

Remarks:

1. Emission Level(dBuV/m) = Raw Value(dBuV) + Correction Factor(dB/m)
2. Correction Factor(dB/m) = Antenna Factor(dB/m) + Cable Factor(dB) – Pre-Amplifier Factor(dB)
3. Margin value = Emission Level – Limit value
4. The other emission levels were very low against the limit.
5. " * ": Fundamental frequency.
6. " # ": The radiated frequency is out of the restricted band.

RF Mode	TX 20MHz Preamble 802.11ax (RU52)	Channel	CH 60 : 5300 MHz
Frequency Range	1GHz ~ 40GHz	Detector Function	Peak (PK) Average (AV)

Antenna Polarity & Test Distance : Horizontal at 3 m

No	Frequency (MHz)	Emission Level (dBuV/m)	Limit (dBuV/m)	Margin (dB)	Antenna Height (m)	Table Angle (Degree)	Raw Value (dBuV)	Correction Factor (dB/m)
1	*5300.00	121.7 PK			1.96 H	96	120.0	1.7
2	*5300.00	110.9 AV			1.96 H	96	109.2	1.7
3	5350.00	54.3 PK	74.0	-19.7	1.96 H	96	52.4	1.9
4	5350.00	39.9 AV	54.0	-14.1	1.96 H	96	38.0	1.9
5	10600.00	49.3 PK	74.0	-24.7	1.57 H	335	37.4	11.9
6	10600.00	36.8 AV	54.0	-17.2	1.57 H	335	24.9	11.9
7	15900.00	61.8 PK	74.0	-12.2	1.29 H	287	50.5	11.3
8	15900.00	47.8 AV	54.0	-6.2	1.29 H	287	36.5	11.3

Antenna Polarity & Test Distance : Vertical at 3 m

No	Frequency (MHz)	Emission Level (dBuV/m)	Limit (dBuV/m)	Margin (dB)	Antenna Height (m)	Table Angle (Degree)	Raw Value (dBuV)	Correction Factor (dB/m)
1	*5300.00	114.5 PK			1.85 V	127	112.8	1.7
2	*5300.00	103.8 AV			1.85 V	127	102.1	1.7
3	5350.00	51.2 PK	74.0	-22.8	1.85 V	127	49.3	1.9
4	5350.00	37.5 AV	54.0	-16.5	1.85 V	127	35.6	1.9
5	10600.00	50.8 PK	74.0	-23.2	2.74 V	250	38.9	11.9
6	10600.00	38.9 AV	54.0	-15.1	2.74 V	250	27.0	11.9
7	15900.00	59.9 PK	74.0	-14.1	1.51 V	268	48.6	11.3
8	15900.00	46.4 AV	54.0	-7.6	1.51 V	268	35.1	11.3

Remarks:

1. Emission Level(dBuV/m) = Raw Value(dBuV) + Correction Factor(dB/m)
2. Correction Factor(dB/m) = Antenna Factor(dB/m) + Cable Factor(dB) – Pre-Amplifier Factor(dB)
3. Margin value = Emission Level – Limit value
4. The other emission levels were very low against the limit.
5. " * ": Fundamental frequency.

RF Mode	TX 20MHz Preamble 802.11ax (RU52)	Channel	CH 64 : 5320 MHz
Frequency Range	1GHz ~ 40GHz	Detector Function	Peak (PK) Average (AV)

Antenna Polarity & Test Distance : Horizontal at 3 m

No	Frequency (MHz)	Emission Level (dBuV/m)	Limit (dBuV/m)	Margin (dB)	Antenna Height (m)	Table Angle (Degree)	Raw Value (dBuV)	Correction Factor (dB/m)
1	*5320.00	121.7 PK			1.98 H	109	119.9	1.8
2	*5320.00	110.8 AV			1.98 H	109	109.0	1.8
3	5356.70	65.5 PK	74.0	-8.5	1.98 H	109	63.5	2.0
4	5356.70	47.2 AV	54.0	-6.8	1.98 H	109	45.2	2.0
5	10640.00	49.4 PK	74.0	-24.6	1.48 H	328	37.6	11.8
6	10640.00	36.3 AV	54.0	-17.7	1.48 H	328	24.5	11.8
7	15960.00	62.2 PK	74.0	-11.8	1.33 H	292	50.6	11.6
8	15960.00	47.9 AV	54.0	-6.1	1.33 H	292	36.3	11.6

Antenna Polarity & Test Distance : Vertical at 3 m

No	Frequency (MHz)	Emission Level (dBuV/m)	Limit (dBuV/m)	Margin (dB)	Antenna Height (m)	Table Angle (Degree)	Raw Value (dBuV)	Correction Factor (dB/m)
1	*5320.00	113.9 PK			1.76 V	115	112.1	1.8
2	*5320.00	103.5 AV			1.76 V	115	101.7	1.8
3	5355.00	58.6 PK	74.0	-15.4	1.76 V	115	56.6	2.0
4	5355.00	42.0 AV	54.0	-12.0	1.76 V	115	40.0	2.0
5	10640.00	50.5 PK	74.0	-23.5	2.73 V	255	38.7	11.8
6	10640.00	38.3 AV	54.0	-15.7	2.73 V	255	26.5	11.8
7	15960.00	60.6 PK	74.0	-13.4	1.49 V	260	49.0	11.6
8	15960.00	46.9 AV	54.0	-7.1	1.49 V	260	35.3	11.6

Remarks:

1. Emission Level(dBuV/m) = Raw Value(dBuV) + Correction Factor(dB/m)
2. Correction Factor(dB/m) = Antenna Factor(dB/m) + Cable Factor(dB) – Pre-Amplifier Factor(dB)
3. Margin value = Emission Level – Limit value
4. The other emission levels were very low against the limit.
5. " * ": Fundamental frequency.

RF Mode	TX 20MHz Preamble 802.11ax (RU52)	Channel	CH 100 : 5500 MHz
Frequency Range	1GHz ~ 40GHz	Detector Function	Peak (PK) Average (AV)

Antenna Polarity & Test Distance : Horizontal at 3 m

No	Frequency (MHz)	Emission Level (dBuV/m)	Limit (dBuV/m)	Margin (dB)	Antenna Height (m)	Table Angle (Degree)	Raw Value (dBuV)	Correction Factor (dB/m)
1	5454.20	54.5 PK	74.0	-19.5	2.03 H	111	52.4	2.1
2	5454.20	43.6 AV	54.0	-10.4	2.03 H	111	41.5	2.1
3	5457.00	56.1 PK	74.0	-17.9	2.03 H	111	54.0	2.1
4	5457.00	43.0 AV	54.0	-11.0	2.03 H	111	40.9	2.1
5	#5462.20	66.6 PK	68.2	-1.6	2.03 H	111	64.5	2.1
6	*5500.00	120.6 PK			2.03 H	111	118.5	2.1
7	*5500.00	109.7 AV			2.03 H	111	107.6	2.1
8	11000.00	49.0 PK	74.0	-25.0	1.57 H	338	36.6	12.4
9	11000.00	36.2 AV	54.0	-17.8	1.57 H	338	23.8	12.4
10	#16500.00	62.1 PK	68.2	-6.1	1.30 H	282	48.4	13.7

Antenna Polarity & Test Distance : Vertical at 3 m

No	Frequency (MHz)	Emission Level (dBuV/m)	Limit (dBuV/m)	Margin (dB)	Antenna Height (m)	Table Angle (Degree)	Raw Value (dBuV)	Correction Factor (dB/m)
1	5460.00	50.8 PK	74.0	-23.2	1.70 V	114	48.7	2.1
2	5460.00	40.0 AV	54.0	-14.0	1.70 V	114	37.9	2.1
3	#5470.00	52.2 PK	68.2	-16.0	1.70 V	114	50.0	2.2
4	*5500.00	112.7 PK			1.70 V	114	110.6	2.1
5	*5500.00	102.6 AV			1.70 V	114	100.5	2.1
6	11000.00	50.8 PK	74.0	-23.2	2.72 V	260	38.4	12.4
7	11000.00	39.0 AV	54.0	-15.0	2.72 V	260	26.6	12.4
8	#16500.00	60.4 PK	68.2	-7.8	1.41 V	270	46.7	13.7

Remarks:

1. Emission Level(dBuV/m) = Raw Value(dBuV) + Correction Factor(dB/m)
2. Correction Factor(dB/m) = Antenna Factor(dB/m) + Cable Factor(dB) – Pre-Amplifier Factor(dB)
3. Margin value = Emission Level – Limit value
4. The other emission levels were very low against the limit.
5. " * ": Fundamental frequency.
6. " # ": The radiated frequency is out of the restricted band.

RF Mode	TX 20MHz Preamble 802.11ax (RU52)	Channel	CH 116 : 5580 MHz
Frequency Range	1GHz ~ 40GHz	Detector Function	Peak (PK) Average (AV)

Antenna Polarity & Test Distance : Horizontal at 3 m

No	Frequency (MHz)	Emission Level (dBuV/m)	Limit (dBuV/m)	Margin (dB)	Antenna Height (m)	Table Angle (Degree)	Raw Value (dBuV)	Correction Factor (dB/m)
1	*5580.00	121.7 PK			2.03 H	123	119.6	2.1
2	*5580.00	110.6 AV			2.03 H	123	108.5	2.1
3	11160.00	49.5 PK	74.0	-24.5	1.57 H	333	37.5	12.0
4	11160.00	36.6 AV	54.0	-17.4	1.57 H	333	24.6	12.0
5	#16740.00	61.8 PK	68.2	-6.4	1.31 H	274	46.5	15.3

Antenna Polarity & Test Distance : Vertical at 3 m

No	Frequency (MHz)	Emission Level (dBuV/m)	Limit (dBuV/m)	Margin (dB)	Antenna Height (m)	Table Angle (Degree)	Raw Value (dBuV)	Correction Factor (dB/m)
1	*5580.00	114.5 PK			1.80 V	119	112.4	2.1
2	*5580.00	104.0 AV			1.80 V	119	101.9	2.1
3	11160.00	50.9 PK	74.0	-23.1	2.70 V	255	38.9	12.0
4	11160.00	39.0 AV	54.0	-15.0	2.70 V	255	27.0	12.0
5	#16740.00	60.7 PK	68.2	-7.5	1.48 V	256	45.4	15.3

Remarks:

1. Emission Level(dBuV/m) = Raw Value(dBuV) + Correction Factor(dB/m)
2. Correction Factor(dB/m) = Antenna Factor(dB/m) + Cable Factor(dB) – Pre-Amplifier Factor(dB)
3. Margin value = Emission Level – Limit value
4. The other emission levels were very low against the limit.
5. " * " : Fundamental frequency.
6. " # " : The radiated frequency is out of the restricted band.

RF Mode	TX 20MHz Preamble 802.11ax (RU52)	Channel	CH 140 : 5700 MHz
Frequency Range	1GHz ~ 40GHz	Detector Function	Peak (PK) Average (AV)

Antenna Polarity & Test Distance : Horizontal at 3 m

No	Frequency (MHz)	Emission Level (dBuV/m)	Limit (dBuV/m)	Margin (dB)	Antenna Height (m)	Table Angle (Degree)	Raw Value (dBuV)	Correction Factor (dB/m)
1	*5700.00	119.5 PK			2.01 H	108	117.2	2.3
2	*5700.00	108.8 AV			2.01 H	108	106.5	2.3
3	#5725.00	66.7 PK	68.2	-1.5	2.01 H	108	64.3	2.4
4	11400.00	49.4 PK	74.0	-24.6	1.49 H	326	36.9	12.5
5	11400.00	36.6 AV	54.0	-17.4	1.49 H	326	24.1	12.5
6	#17100.00	62.5 PK	68.2	-5.7	1.37 H	298	45.7	16.8

Antenna Polarity & Test Distance : Vertical at 3 m

No	Frequency (MHz)	Emission Level (dBuV/m)	Limit (dBuV/m)	Margin (dB)	Antenna Height (m)	Table Angle (Degree)	Raw Value (dBuV)	Correction Factor (dB/m)
1	*5700.00	115.5 PK			1.74 V	106	113.2	2.3
2	*5700.00	101.1 AV			1.74 V	106	98.8	2.3
3	#5725.00	56.9 PK	68.2	-11.3	1.74 V	106	54.5	2.4
4	11400.00	50.9 PK	74.0	-23.1	2.78 V	251	38.4	12.5
5	11400.00	38.8 AV	54.0	-15.2	2.78 V	251	26.3	12.5
6	#17100.00	60.9 PK	68.2	-7.3	1.45 V	267	44.1	16.8

Remarks:

1. Emission Level(dBuV/m) = Raw Value(dBuV) + Correction Factor(dB/m)
2. Correction Factor(dB/m) = Antenna Factor(dB/m) + Cable Factor(dB) – Pre-Amplifier Factor(dB)
3. Margin value = Emission Level – Limit value
4. The other emission levels were very low against the limit.
5. " * ": Fundamental frequency.
6. " # ": The radiated frequency is out of the restricted band.

RF Mode	TX 20MHz Preamble 802.11ax (RU52)	Channel	CH 144 : 5720 MHz
Frequency Range	1GHz ~ 40GHz	Detector Function	Peak (PK) Average (AV)

Antenna Polarity & Test Distance : Horizontal at 3 m

No	Frequency (MHz)	Emission Level (dBuV/m)	Limit (dBuV/m)	Margin (dB)	Antenna Height (m)	Table Angle (Degree)	Raw Value (dBuV)	Correction Factor (dB/m)
1	5460.00	52.4 PK	74.0	-21.6	2.04 H	102	50.3	2.1
2	5460.00	38.6 AV	54.0	-15.4	2.04 H	102	36.5	2.1
3	#5470.00	53.1 PK	68.2	-15.1	2.04 H	102	50.9	2.2
4	*5720.00	121.8 PK			2.04 H	102	119.4	2.4
5	*5720.00	111.0 AV			2.04 H	102	108.6	2.4
6	#5850.00	52.5 PK	68.2	-15.7	2.04 H	102	49.8	2.7
7	11440.00	49.1 PK	74.0	-24.9	1.49 H	330	36.7	12.4
8	11440.00	36.4 AV	54.0	-17.6	1.49 H	330	24.0	12.4
9	#17160.00	62.3 PK	68.2	-5.9	1.37 H	294	45.7	16.6

Antenna Polarity & Test Distance : Vertical at 3 m

No	Frequency (MHz)	Emission Level (dBuV/m)	Limit (dBuV/m)	Margin (dB)	Antenna Height (m)	Table Angle (Degree)	Raw Value (dBuV)	Correction Factor (dB/m)
1	5460.00	51.4 PK	74.0	-22.6	1.83 V	125	49.3	2.1
2	5460.00	38.2 AV	54.0	-15.8	1.83 V	125	36.1	2.1
3	#5470.00	50.6 PK	68.2	-17.6	1.83 V	125	48.4	2.2
4	*5720.00	114.5 PK			1.83 V	125	112.1	2.4
5	*5720.00	104.0 AV			1.83 V	125	101.6	2.4
6	#5850.00	50.8 PK	68.2	-17.4	1.83 V	125	48.1	2.7
7	11440.00	50.5 PK	74.0	-23.5	2.74 V	258	38.1	12.4
8	11440.00	38.8 AV	54.0	-15.2	2.74 V	258	26.4	12.4
9	#17160.00	60.2 PK	68.2	-8.0	1.42 V	254	43.6	16.6

Remarks:

1. Emission Level(dBuV/m) = Raw Value(dBuV) + Correction Factor(dB/m)
2. Correction Factor(dB/m) = Antenna Factor(dB/m) + Cable Factor(dB) – Pre-Amplifier Factor(dB)
3. Margin value = Emission Level – Limit value
4. The other emission levels were very low against the limit.
5. " * ": Fundamental frequency.
6. " # ": The radiated frequency is out of the restricted band.

RF Mode	TX 20MHz Preamble 802.11ax (RU52)	Channel	CH 149 : 5745 MHz
Frequency Range	1GHz ~ 40GHz	Detector Function	Peak (PK) Average (AV)

Antenna Polarity & Test Distance : Horizontal at 3 m

No	Frequency (MHz)	Emission Level (dBuV/m)	Limit (dBuV/m)	Margin (dB)	Antenna Height (m)	Table Angle (Degree)	Raw Value (dBuV)	Correction Factor (dB/m)
1	#5648.23	52.7 PK	68.2	-15.5	2.04 H	110	50.4	2.3
2	*5745.00	122.5 PK			2.04 H	110	120.1	2.4
3	*5745.00	113.2 AV			2.04 H	110	110.8	2.4
4	#5985.42	52.1 PK	68.2	-16.1	2.04 H	110	49.2	2.9
5	11490.00	49.5 PK	74.0	-24.5	1.55 H	350	36.9	12.6
6	11490.00	37.1 AV	54.0	-16.9	1.55 H	350	24.5	12.6
7	#17235.00	64.4 PK	68.2	-3.8	1.24 H	280	47.6	16.8

Antenna Polarity & Test Distance : Vertical at 3 m

No	Frequency (MHz)	Emission Level (dBuV/m)	Limit (dBuV/m)	Margin (dB)	Antenna Height (m)	Table Angle (Degree)	Raw Value (dBuV)	Correction Factor (dB/m)
1	#5562.22	52.3 PK	68.2	-15.9	1.67 V	108	50.2	2.1
2	*5745.00	116.9 PK			1.67 V	108	114.5	2.4
3	*5745.00	106.3 AV			1.67 V	108	103.9	2.4
4	#5939.88	51.3 PK	68.2	-16.9	1.67 V	108	48.4	2.9
5	11490.00	50.7 PK	74.0	-23.3	2.72 V	234	38.1	12.6
6	11490.00	38.4 AV	54.0	-15.6	2.72 V	234	25.8	12.6
7	#17235.00	62.9 PK	68.2	-5.3	1.44 V	269	46.1	16.8

Remarks:

1. Emission Level(dBuV/m) = Raw Value(dBuV) + Correction Factor(dB/m)
2. Correction Factor(dB/m) = Antenna Factor(dB/m) + Cable Factor(dB) – Pre-Amplifier Factor(dB)
3. Margin value = Emission Level – Limit value
4. The other emission levels were very low against the limit.
5. " * ": Fundamental frequency.
6. " # ": The radiated frequency is out of the restricted band.

RF Mode	TX 20MHz Preamble 802.11ax (RU52)	Channel	CH 157 : 5785 MHz
Frequency Range	1GHz ~ 40GHz	Detector Function	Peak (PK) Average (AV)

Antenna Polarity & Test Distance : Horizontal at 3 m

No	Frequency (MHz)	Emission Level (dBuV/m)	Limit (dBuV/m)	Margin (dB)	Antenna Height (m)	Table Angle (Degree)	Raw Value (dBuV)	Correction Factor (dB/m)
1	#5563.26	52.8 PK	68.2	-15.4	2.03 H	114	50.7	2.1
2	*5785.00	122.3 PK			2.03 H	114	119.7	2.6
3	*5785.00	113.1 AV			2.03 H	114	110.5	2.6
4	#5987.48	52.1 PK	68.2	-16.1	2.03 H	114	49.2	2.9
5	11570.00	49.7 PK	74.0	-24.3	1.49 H	358	37.1	12.6
6	11570.00	37.3 AV	54.0	-16.7	1.49 H	358	24.7	12.6
7	#17355.00	62.1 PK	68.2	-6.1	1.01 H	277	44.4	17.7

Antenna Polarity & Test Distance : Vertical at 3 m

No	Frequency (MHz)	Emission Level (dBuV/m)	Limit (dBuV/m)	Margin (dB)	Antenna Height (m)	Table Angle (Degree)	Raw Value (dBuV)	Correction Factor (dB/m)
1	#5565.37	51.0 PK	68.2	-17.2	1.70 V	105	48.9	2.1
2	*5785.00	116.7 PK			1.70 V	105	114.1	2.6
3	*5785.00	106.2 AV			1.70 V	105	103.6	2.6
4	#5985.60	51.0 PK	68.2	-17.2	1.70 V	105	48.1	2.9
5	11570.00	50.4 PK	74.0	-23.6	2.73 V	248	37.8	12.6
6	11570.00	38.2 AV	54.0	-15.8	2.73 V	248	25.6	12.6
7	#17355.00	62.5 PK	68.2	-5.7	1.47 V	273	44.8	17.7

Remarks:

1. Emission Level(dBuV/m) = Raw Value(dBuV) + Correction Factor(dB/m)
2. Correction Factor(dB/m) = Antenna Factor(dB/m) + Cable Factor(dB) – Pre-Amplifier Factor(dB)
3. Margin value = Emission Level – Limit value
4. The other emission levels were very low against the limit.
5. " * ": Fundamental frequency.
6. " # ": The radiated frequency is out of the restricted band.

RF Mode	TX 20MHz Preamble 802.11ax (RU52)	Channel	CH 165 : 5825 MHz
Frequency Range	1GHz ~ 40GHz	Detector Function	Peak (PK) Average (AV)

Antenna Polarity & Test Distance : Horizontal at 3 m

No	Frequency (MHz)	Emission Level (dBuV/m)	Limit (dBuV/m)	Margin (dB)	Antenna Height (m)	Table Angle (Degree)	Raw Value (dBuV)	Correction Factor (dB/m)
1	#5588.77	53.6 PK	68.2	-14.6	1.99 H	107	51.5	2.1
2	*5825.00	122.8 PK			1.99 H	107	120.2	2.6
3	*5825.00	113.3 AV			1.99 H	107	110.7	2.6
4	#5948.98	51.5 PK	68.2	-16.7	1.99 H	107	48.6	2.9
5	11650.00	49.6 PK	74.0	-24.4	1.51 H	346	37.4	12.2
6	11650.00	36.9 AV	54.0	-17.1	1.51 H	346	24.7	12.2
7	#17475.00	62.9 PK	68.2	-5.3	1.30 H	280	44.2	18.7

Antenna Polarity & Test Distance : Vertical at 3 m

No	Frequency (MHz)	Emission Level (dBuV/m)	Limit (dBuV/m)	Margin (dB)	Antenna Height (m)	Table Angle (Degree)	Raw Value (dBuV)	Correction Factor (dB/m)
1	#5582.60	52.3 PK	68.2	-15.9	1.63 V	108	50.2	2.1
2	*5825.00	117.0 PK			1.63 V	108	114.4	2.6
3	*5825.00	106.4 AV			1.63 V	108	103.8	2.6
4	#5972.26	51.6 PK	68.2	-16.6	1.63 V	108	48.7	2.9
5	11650.00	51.1 PK	74.0	-22.9	2.75 V	238	38.9	12.2
6	11650.00	38.7 AV	54.0	-15.3	2.75 V	238	26.5	12.2
7	#17475.00	62.0 PK	68.2	-6.2	1.45 V	257	43.3	18.7

Remarks:

1. Emission Level(dBuV/m) = Raw Value(dBuV) + Correction Factor(dB/m)
2. Correction Factor(dB/m) = Antenna Factor(dB/m) + Cable Factor(dB) – Pre-Amplifier Factor(dB)
3. Margin value = Emission Level – Limit value
4. The other emission levels were very low against the limit.
5. " * ": Fundamental frequency.
6. " # ": The radiated frequency is out of the restricted band.

RF Mode	TX 20MHz Preamble 802.11ax (RU106)	Channel	CH 36 : 5180 MHz
Frequency Range	1GHz ~ 40GHz	Detector Function	Peak (PK) Average (AV)

Antenna Polarity & Test Distance : Horizontal at 3 m

No	Frequency (MHz)	Emission Level (dBuV/m)	Limit (dBuV/m)	Margin (dB)	Antenna Height (m)	Table Angle (Degree)	Raw Value (dBuV)	Correction Factor (dB/m)
1	5148.36	72.5 PK	74.0	-1.5	2.03 H	100	70.2	2.3
2	5148.36	45.6 AV	54.0	-8.4	2.03 H	100	43.3	2.3
3	*5180.00	119.6 PK			2.03 H	100	117.4	2.2
4	*5180.00	108.2 AV			2.03 H	100	106.0	2.2
5	#10360.00	47.5 PK	68.2	-20.7	1.56 H	337	35.7	11.8
6	15540.00	58.4 PK	74.0	-15.6	1.13 H	281	46.6	11.8
7	15540.00	46.7 AV	54.0	-7.3	1.13 H	281	34.9	11.8

Antenna Polarity & Test Distance : Vertical at 3 m

No	Frequency (MHz)	Emission Level (dBuV/m)	Limit (dBuV/m)	Margin (dB)	Antenna Height (m)	Table Angle (Degree)	Raw Value (dBuV)	Correction Factor (dB/m)
1	5150.00	50.7 PK	74.0	-23.3	2.02 V	118	48.4	2.3
2	5150.00	40.8 AV	54.0	-13.2	2.02 V	118	38.5	2.3
3	*5180.00	112.7 PK			2.02 V	118	110.5	2.2
4	*5180.00	101.3 AV			2.02 V	118	99.1	2.2
5	#10360.00	48.2 PK	68.2	-20.0	2.76 V	255	36.4	11.8
6	15540.00	57.6 PK	74.0	-16.4	1.48 V	262	45.8	11.8
7	15540.00	45.5 AV	54.0	-8.5	1.48 V	262	33.7	11.8

Remarks:

1. Emission Level(dBuV/m) = Raw Value(dBuV) + Correction Factor(dB/m)
2. Correction Factor(dB/m) = Antenna Factor(dB/m) + Cable Factor(dB) – Pre-Amplifier Factor(dB)
3. Margin value = Emission Level – Limit value
4. The other emission levels were very low against the limit.
5. " * ": Fundamental frequency.
6. " # ": The radiated frequency is out of the restricted band.

RF Mode	TX 20MHz Preamble 802.11ax (RU106)	Channel	CH 40 : 5200 MHz
Frequency Range	1GHz ~ 40GHz	Detector Function	Peak (PK) Average (AV)

Antenna Polarity & Test Distance : Horizontal at 3 m

No	Frequency (MHz)	Emission Level (dBuV/m)	Limit (dBuV/m)	Margin (dB)	Antenna Height (m)	Table Angle (Degree)	Raw Value (dBuV)	Correction Factor (dB/m)
1	5150.00	53.6 PK	74.0	-20.4	2.06 H	103	51.3	2.3
2	5150.00	39.4 AV	54.0	-14.6	2.06 H	103	37.1	2.3
3	*5200.00	120.8 PK			2.06 H	103	118.7	2.1
4	*5200.00	109.2 AV			2.06 H	103	107.1	2.1
5	#10400.00	48.0 PK	68.2	-20.2	1.62 H	351	36.0	12.0
6	15600.00	58.3 PK	74.0	-15.7	1.17 H	294	46.8	11.5
7	15600.00	46.3 AV	54.0	-7.7	1.17 H	294	34.8	11.5

Antenna Polarity & Test Distance : Vertical at 3 m

No	Frequency (MHz)	Emission Level (dBuV/m)	Limit (dBuV/m)	Margin (dB)	Antenna Height (m)	Table Angle (Degree)	Raw Value (dBuV)	Correction Factor (dB/m)
1	5150.00	50.5 PK	74.0	-23.5	2.00 V	102	48.2	2.3
2	5150.00	37.2 AV	54.0	-16.8	2.00 V	102	34.9	2.3
3	*5200.00	113.3 PK			2.00 V	102	111.2	2.1
4	*5200.00	102.3 AV			2.00 V	102	100.2	2.1
5	#10400.00	47.8 PK	68.2	-20.4	2.72 V	242	35.8	12.0
6	15600.00	58.0 PK	74.0	-16.0	1.46 V	275	46.5	11.5
7	15600.00	45.7 AV	54.0	-8.3	1.46 V	275	34.2	11.5

Remarks:

1. Emission Level(dBuV/m) = Raw Value(dBuV) + Correction Factor(dB/m)
2. Correction Factor(dB/m) = Antenna Factor(dB/m) + Cable Factor(dB) – Pre-Amplifier Factor(dB)
3. Margin value = Emission Level – Limit value
4. The other emission levels were very low against the limit.
5. " * ": Fundamental frequency.
6. " # ": The radiated frequency is out of the restricted band.

RF Mode	TX 20MHz Preamble 802.11ax (RU106)	Channel	CH 48 : 5240 MHz
Frequency Range	1GHz ~ 40GHz	Detector Function	Peak (PK) Average (AV)

Antenna Polarity & Test Distance : Horizontal at 3 m

No	Frequency (MHz)	Emission Level (dBuV/m)	Limit (dBuV/m)	Margin (dB)	Antenna Height (m)	Table Angle (Degree)	Raw Value (dBuV)	Correction Factor (dB/m)
1	5150.00	54.3 PK	74.0	-19.7	2.07 H	89	52.0	2.3
2	5150.00	40.1 AV	54.0	-13.9	2.07 H	89	37.8	2.3
3	*5240.00	120.4 PK			2.07 H	89	118.4	2.0
4	*5240.00	108.8 AV			2.07 H	89	106.8	2.0
5	5350.00	52.7 PK	74.0	-21.3	2.07 H	89	50.8	1.9
6	5350.00	38.8 AV	54.0	-15.2	2.07 H	89	36.9	1.9
7	#10480.00	47.8 PK	68.2	-20.4	1.54 H	343	35.9	11.9
8	15720.00	59.0 PK	74.0	-15.0	1.18 H	289	47.2	11.8
9	15720.00	47.0 AV	54.0	-7.0	1.18 H	289	35.2	11.8

Antenna Polarity & Test Distance : Vertical at 3 m

No	Frequency (MHz)	Emission Level (dBuV/m)	Limit (dBuV/m)	Margin (dB)	Antenna Height (m)	Table Angle (Degree)	Raw Value (dBuV)	Correction Factor (dB/m)
1	5150.00	51.2 PK	74.0	-22.8	1.97 V	103	48.9	2.3
2	5150.00	38.0 AV	54.0	-16.0	1.97 V	103	35.7	2.3
3	*5240.00	113.1 PK			1.97 V	103	111.1	2.0
4	*5240.00	101.8 AV			1.97 V	103	99.8	2.0
5	5350.00	48.4 PK	74.0	-25.6	1.97 V	103	46.5	1.9
6	5350.00	36.9 AV	54.0	-17.1	1.97 V	103	35.0	1.9
7	#10480.00	47.8 PK	68.2	-20.4	2.75 V	256	35.9	11.9
8	15720.00	57.4 PK	74.0	-16.6	1.50 V	276	45.6	11.8
9	15720.00	45.4 AV	54.0	-8.6	1.50 V	276	33.6	11.8

Remarks:

1. Emission Level(dBuV/m) = Raw Value(dBuV) + Correction Factor(dB/m)
2. Correction Factor(dB/m) = Antenna Factor(dB/m) + Cable Factor(dB) – Pre-Amplifier Factor(dB)
3. Margin value = Emission Level – Limit value
4. The other emission levels were very low against the limit.
5. " * ": Fundamental frequency.
6. " # ": The radiated frequency is out of the restricted band.

RF Mode	TX 20MHz Preamble 802.11ax (RU106)	Channel	CH 52 : 5260 MHz
Frequency Range	1GHz ~ 40GHz	Detector Function	Peak (PK) Average (AV)

Antenna Polarity & Test Distance : Horizontal at 3 m

No	Frequency (MHz)	Emission Level (dBuV/m)	Limit (dBuV/m)	Margin (dB)	Antenna Height (m)	Table Angle (Degree)	Raw Value (dBuV)	Correction Factor (dB/m)
1	5150.00	54.3 PK	74.0	-19.7	2.00 H	106	52.0	2.3
2	5150.00	40.2 AV	54.0	-13.8	2.00 H	106	37.9	2.3
3	*5260.00	120.8 PK			2.00 H	106	118.8	2.0
4	*5260.00	109.1 AV			2.00 H	106	107.1	2.0
5	5350.00	52.8 PK	74.0	-21.2	2.00 H	106	50.9	1.9
6	5350.00	39.2 AV	54.0	-14.8	2.00 H	106	37.3	1.9
7	#10520.00	47.1 PK	68.2	-21.1	1.51 H	342	35.1	12.0
8	15780.00	58.2 PK	74.0	-15.8	1.16 H	280	46.7	11.5
9	15780.00	46.6 AV	54.0	-7.4	1.16 H	280	35.1	11.5

Antenna Polarity & Test Distance : Vertical at 3 m

No	Frequency (MHz)	Emission Level (dBuV/m)	Limit (dBuV/m)	Margin (dB)	Antenna Height (m)	Table Angle (Degree)	Raw Value (dBuV)	Correction Factor (dB/m)
1	5150.00	50.8 PK	74.0	-23.2	1.95 V	99	48.5	2.3
2	5150.00	37.7 AV	54.0	-16.3	1.95 V	99	35.4	2.3
3	*5260.00	113.3 PK			1.95 V	99	111.3	2.0
4	*5260.00	102.2 AV			1.95 V	99	100.2	2.0
5	5350.00	48.4 PK	74.0	-25.6	1.95 V	99	46.5	1.9
6	5350.00	36.7 AV	54.0	-17.3	1.95 V	99	34.8	1.9
7	#10520.00	48.1 PK	68.2	-20.1	2.72 V	258	36.1	12.0
8	15780.00	57.7 PK	74.0	-16.3	1.44 V	264	46.2	11.5
9	15780.00	45.6 AV	54.0	-8.4	1.44 V	264	34.1	11.5

Remarks:

1. Emission Level(dBuV/m) = Raw Value(dBuV) + Correction Factor(dB/m)
2. Correction Factor(dB/m) = Antenna Factor(dB/m) + Cable Factor(dB) – Pre-Amplifier Factor(dB)
3. Margin value = Emission Level – Limit value
4. The other emission levels were very low against the limit.
5. " * ": Fundamental frequency.
6. " # ": The radiated frequency is out of the restricted band.

RF Mode	TX 20MHz Preamble 802.11ax (RU106)	Channel	CH 60 : 5300 MHz
Frequency Range	1GHz ~ 40GHz	Detector Function	Peak (PK) Average (AV)

Antenna Polarity & Test Distance : Horizontal at 3 m

No	Frequency (MHz)	Emission Level (dBuV/m)	Limit (dBuV/m)	Margin (dB)	Antenna Height (m)	Table Angle (Degree)	Raw Value (dBuV)	Correction Factor (dB/m)
1	*5300.00	120.3 PK			2.03 H	105	118.6	1.7
2	*5300.00	108.8 AV			2.03 H	105	107.1	1.7
3	5350.00	53.8 PK	74.0	-20.2	2.03 H	105	51.9	1.9
4	5350.00	39.5 AV	54.0	-14.5	2.03 H	105	37.6	1.9
5	10600.00	47.6 PK	74.0	-26.4	1.62 H	344	35.7	11.9
6	10600.00	36.2 AV	54.0	-17.8	1.62 H	344	24.3	11.9
7	15900.00	58.2 PK	74.0	-15.8	1.15 H	273	46.9	11.3
8	15900.00	46.8 AV	54.0	-7.2	1.15 H	273	35.5	11.3

Antenna Polarity & Test Distance : Vertical at 3 m

No	Frequency (MHz)	Emission Level (dBuV/m)	Limit (dBuV/m)	Margin (dB)	Antenna Height (m)	Table Angle (Degree)	Raw Value (dBuV)	Correction Factor (dB/m)
1	*5300.00	113.7 PK			2.01 V	96	112.0	1.7
2	*5300.00	102.5 AV			2.01 V	96	100.8	1.7
3	5350.00	51.0 PK	74.0	-23.0	2.01 V	96	49.1	1.9
4	5350.00	37.7 AV	54.0	-16.3	2.01 V	96	35.8	1.9
5	10600.00	48.7 PK	74.0	-25.3	2.77 V	250	36.8	11.9
6	10600.00	37.7 AV	54.0	-16.3	2.77 V	250	25.8	11.9
7	15900.00	57.9 PK	74.0	-16.1	1.52 V	248	46.6	11.3
8	15900.00	45.7 AV	54.0	-8.3	1.52 V	248	34.4	11.3

Remarks:

1. Emission Level(dBuV/m) = Raw Value(dBuV) + Correction Factor(dB/m)
2. Correction Factor(dB/m) = Antenna Factor(dB/m) + Cable Factor(dB) – Pre-Amplifier Factor(dB)
3. Margin value = Emission Level – Limit value
4. The other emission levels were very low against the limit.
5. " * ": Fundamental frequency.

RF Mode	TX 20MHz Preamble 802.11ax (RU106)	Channel	CH 64 : 5320 MHz
Frequency Range	1GHz ~ 40GHz	Detector Function	Peak (PK) Average (AV)

Antenna Polarity & Test Distance : Horizontal at 3 m

No	Frequency (MHz)	Emission Level (dBuV/m)	Limit (dBuV/m)	Margin (dB)	Antenna Height (m)	Table Angle (Degree)	Raw Value (dBuV)	Correction Factor (dB/m)
1	*5320.00	118.9 PK			2.01 H	101	117.1	1.8
2	*5320.00	107.7 AV			2.01 H	101	105.9	1.8
3	5351.20	72.5 PK	74.0	-1.5	2.01 H	101	70.6	1.9
4	5351.20	44.5 AV	54.0	-9.5	2.01 H	101	42.6	1.9
5	10640.00	47.1 PK	74.0	-26.9	1.54 H	325	35.3	11.8
6	10640.00	36.0 AV	54.0	-18.0	1.54 H	325	24.2	11.8
7	15960.00	58.1 PK	74.0	-15.9	1.15 H	293	46.5	11.6
8	15960.00	46.4 AV	54.0	-7.6	1.15 H	293	34.8	11.6

Antenna Polarity & Test Distance : Vertical at 3 m

No	Frequency (MHz)	Emission Level (dBuV/m)	Limit (dBuV/m)	Margin (dB)	Antenna Height (m)	Table Angle (Degree)	Raw Value (dBuV)	Correction Factor (dB/m)
1	*5320.00	111.6 PK			1.98 V	115	109.8	1.8
2	*5320.00	100.7 AV			1.98 V	115	98.9	1.8
3	5354.70	63.5 PK	74.0	-10.5	1.98 V	115	61.5	2.0
4	5354.70	39.9 AV	54.0	-14.1	1.98 V	115	37.9	2.0
5	10640.00	48.0 PK	74.0	-26.0	2.77 V	262	36.2	11.8
6	10640.00	37.3 AV	54.0	-16.7	2.77 V	262	25.5	11.8
7	15960.00	57.4 PK	74.0	-16.6	1.54 V	247	45.8	11.6
8	15960.00	45.4 AV	54.0	-8.6	1.54 V	247	33.8	11.6

Remarks:

1. Emission Level(dBuV/m) = Raw Value(dBuV) + Correction Factor(dB/m)
2. Correction Factor(dB/m) = Antenna Factor(dB/m) + Cable Factor(dB) – Pre-Amplifier Factor(dB)
3. Margin value = Emission Level – Limit value
4. The other emission levels were very low against the limit.
5. " * ": Fundamental frequency.

RF Mode	TX 20MHz Preamble 802.11ax (RU106)	Channel	CH 100 : 5500 MHz
Frequency Range	1GHz ~ 40GHz	Detector Function	Peak (PK) Average (AV)

Antenna Polarity & Test Distance : Horizontal at 3 m

No	Frequency (MHz)	Emission Level (dBuV/m)	Limit (dBuV/m)	Margin (dB)	Antenna Height (m)	Table Angle (Degree)	Raw Value (dBuV)	Correction Factor (dB/m)
1	5455.60	56.9 PK	74.0	-17.1	2.04 H	103	54.8	2.1
2	5455.60	43.3 AV	54.0	-10.7	2.04 H	103	41.2	2.1
3	5457.70	54.5 PK	74.0	-19.5	2.04 H	103	52.4	2.1
4	5457.70	43.9 AV	54.0	-10.1	2.04 H	103	41.8	2.1
5	#5470.00	66.4 PK	68.2	-1.8	2.04 H	103	64.2	2.2
6	*5500.00	119.9 PK			2.04 H	103	117.8	2.1
7	*5500.00	108.3 AV			2.04 H	103	106.2	2.1
8	11000.00	47.5 PK	74.0	-26.5	1.54 H	352	35.1	12.4
9	11000.00	36.4 AV	54.0	-17.6	1.54 H	352	24.0	12.4
10	#16500.00	58.5 PK	68.2	-9.7	1.09 H	294	44.8	13.7

Antenna Polarity & Test Distance : Vertical at 3 m

No	Frequency (MHz)	Emission Level (dBuV/m)	Limit (dBuV/m)	Margin (dB)	Antenna Height (m)	Table Angle (Degree)	Raw Value (dBuV)	Correction Factor (dB/m)
1	5458.32	53.9 PK	74.0	-20.1	2.00 V	117	51.8	2.1
2	5458.32	39.0 AV	54.0	-15.0	2.00 V	117	36.9	2.1
3	#5470.00	62.6 PK	68.2	-5.6	2.00 V	117	60.4	2.2
4	*5500.00	112.3 PK			2.00 V	117	110.2	2.1
5	*5500.00	101.2 AV			2.00 V	117	99.1	2.1
6	11000.00	48.5 PK	74.0	-25.5	2.80 V	266	36.1	12.4
7	11000.00	37.6 AV	54.0	-16.4	2.80 V	266	25.2	12.4
8	#16500.00	57.4 PK	68.2	-10.8	1.47 V	247	43.7	13.7

Remarks:

1. Emission Level(dBuV/m) = Raw Value(dBuV) + Correction Factor(dB/m)
2. Correction Factor(dB/m) = Antenna Factor(dB/m) + Cable Factor(dB) – Pre-Amplifier Factor(dB)
3. Margin value = Emission Level – Limit value
4. The other emission levels were very low against the limit.
5. " * ": Fundamental frequency.
6. " # ": The radiated frequency is out of the restricted band.

RF Mode	TX 20MHz Preamble 802.11ax (RU106)	Channel	CH 116 : 5580 MHz
Frequency Range	1GHz ~ 40GHz	Detector Function	Peak (PK) Average (AV)

Antenna Polarity & Test Distance : Horizontal at 3 m

No	Frequency (MHz)	Emission Level (dBuV/m)	Limit (dBuV/m)	Margin (dB)	Antenna Height (m)	Table Angle (Degree)	Raw Value (dBuV)	Correction Factor (dB/m)
1	*5580.00	120.9 PK			2.07 H	102	118.8	2.1
2	*5580.00	109.6 AV			2.07 H	102	107.5	2.1
3	11160.00	47.5 PK	74.0	-26.5	1.60 H	324	35.5	12.0
4	11160.00	36.3 AV	54.0	-17.7	1.60 H	324	24.3	12.0
5	#16740.00	58.8 PK	68.2	-9.4	1.14 H	275	43.5	15.3

Antenna Polarity & Test Distance : Vertical at 3 m

No	Frequency (MHz)	Emission Level (dBuV/m)	Limit (dBuV/m)	Margin (dB)	Antenna Height (m)	Table Angle (Degree)	Raw Value (dBuV)	Correction Factor (dB/m)
1	*5580.00	112.6 PK			2.02 V	95	110.5	2.1
2	*5580.00	101.9 AV			2.02 V	95	99.8	2.1
3	11160.00	48.0 PK	74.0	-26.0	2.79 V	248	36.0	12.0
4	11160.00	37.0 AV	54.0	-17.0	2.79 V	248	25.0	12.0
5	#16740.00	57.5 PK	68.2	-10.7	1.53 V	277	42.2	15.3

Remarks:

1. Emission Level(dBuV/m) = Raw Value(dBuV) + Correction Factor(dB/m)
2. Correction Factor(dB/m) = Antenna Factor(dB/m) + Cable Factor(dB) – Pre-Amplifier Factor(dB)
3. Margin value = Emission Level – Limit value
4. The other emission levels were very low against the limit.
5. " * ": Fundamental frequency.
6. " # ": The radiated frequency is out of the restricted band.

RF Mode	TX 20MHz Preamble 802.11ax (RU106)	Channel	CH 140 : 5700 MHz
Frequency Range	1GHz ~ 40GHz	Detector Function	Peak (PK) Average (AV)

Antenna Polarity & Test Distance : Horizontal at 3 m

No	Frequency (MHz)	Emission Level (dBuV/m)	Limit (dBuV/m)	Margin (dB)	Antenna Height (m)	Table Angle (Degree)	Raw Value (dBuV)	Correction Factor (dB/m)
1	*5700.00	120.1 PK			1.99 H	107	117.8	2.3
2	*5700.00	108.4 AV			1.99 H	107	106.1	2.3
3	#5732.01	66.4 PK	68.2	-1.8	1.99 H	107	63.9	2.5
4	11400.00	48.0 PK	74.0	-26.0	1.57 H	350	35.5	12.5
5	11400.00	36.8 AV	54.0	-17.2	1.57 H	350	24.3	12.5
6	#17100.00	58.6 PK	68.2	-9.6	1.14 H	272	41.8	16.8

Antenna Polarity & Test Distance : Vertical at 3 m

No	Frequency (MHz)	Emission Level (dBuV/m)	Limit (dBuV/m)	Margin (dB)	Antenna Height (m)	Table Angle (Degree)	Raw Value (dBuV)	Correction Factor (dB/m)
1	*5700.00	119.8 PK			2.05 V	103	117.5	2.3
2	*5700.00	100.9 AV			2.05 V	103	98.6	2.3
3	#5725.00	58.4 PK	68.2	-9.8	2.05 V	103	56.0	2.4
4	11400.00	47.9 PK	74.0	-26.1	2.72 V	269	35.4	12.5
5	11400.00	37.3 AV	54.0	-16.7	2.72 V	269	24.8	12.5
6	#17100.00	57.1 PK	68.2	-11.1	1.54 V	247	40.3	16.8

Remarks:

1. Emission Level(dBuV/m) = Raw Value(dBuV) + Correction Factor(dB/m)
2. Correction Factor(dB/m) = Antenna Factor(dB/m) + Cable Factor(dB) – Pre-Amplifier Factor(dB)
3. Margin value = Emission Level – Limit value
4. The other emission levels were very low against the limit.
5. " * ": Fundamental frequency.
6. " # ": The radiated frequency is out of the restricted band.

RF Mode	TX 20MHz Preamble 802.11ax (RU106)	Channel	CH 144 : 5720 MHz
Frequency Range	1GHz ~ 40GHz	Detector Function	Peak (PK) Average (AV)

Antenna Polarity & Test Distance : Horizontal at 3 m

No	Frequency (MHz)	Emission Level (dBuV/m)	Limit (dBuV/m)	Margin (dB)	Antenna Height (m)	Table Angle (Degree)	Raw Value (dBuV)	Correction Factor (dB/m)
1	5460.00	52.2 PK	74.0	-21.8	2.04 H	90	50.1	2.1
2	5460.00	38.6 AV	54.0	-15.4	2.04 H	90	36.5	2.1
3	#5470.00	52.8 PK	68.2	-15.4	2.04 H	90	50.6	2.2
4	*5720.00	120.9 PK			2.04 H	90	118.5	2.4
5	*5720.00	109.1 AV			2.04 H	90	106.7	2.4
6	#5850.00	52.3 PK	68.2	-15.9	2.04 H	90	49.6	2.7
7	11440.00	47.7 PK	74.0	-26.3	1.60 H	339	35.3	12.4
8	11440.00	36.7 AV	54.0	-17.3	1.60 H	339	24.3	12.4
9	#17160.00	58.6 PK	68.2	-9.6	1.15 H	295	42.0	16.6

Antenna Polarity & Test Distance : Vertical at 3 m

No	Frequency (MHz)	Emission Level (dBuV/m)	Limit (dBuV/m)	Margin (dB)	Antenna Height (m)	Table Angle (Degree)	Raw Value (dBuV)	Correction Factor (dB/m)
1	5460.00	51.5 PK	74.0	-22.5	1.97 V	101	49.4	2.1
2	5460.00	38.3 AV	54.0	-15.7	1.97 V	101	36.2	2.1
3	#5470.00	51.1 PK	68.2	-17.1	1.97 V	101	48.9	2.2
4	*5720.00	114.1 PK			1.97 V	101	111.7	2.4
5	*5720.00	102.9 AV			1.97 V	101	100.5	2.4
6	#5850.00	51.1 PK	68.2	-17.1	1.97 V	101	48.4	2.7
7	11440.00	47.8 PK	74.0	-26.2	2.77 V	251	35.4	12.4
8	11440.00	37.1 AV	54.0	-16.9	2.77 V	251	24.7	12.4
9	#17160.00	57.9 PK	68.2	-10.3	1.42 V	260	41.3	16.6

Remarks:

1. Emission Level(dBuV/m) = Raw Value(dBuV) + Correction Factor(dB/m)
2. Correction Factor(dB/m) = Antenna Factor(dB/m) + Cable Factor(dB) – Pre-Amplifier Factor(dB)
3. Margin value = Emission Level – Limit value
4. The other emission levels were very low against the limit.
5. " * ": Fundamental frequency.
6. " # ": The radiated frequency is out of the restricted band.

RF Mode	TX 20MHz Preamble 802.11ax (RU106)	Channel	CH 149 : 5745 MHz
Frequency Range	1GHz ~ 40GHz	Detector Function	Peak (PK) Average (AV)

Antenna Polarity & Test Distance : Horizontal at 3 m

No	Frequency (MHz)	Emission Level (dBuV/m)	Limit (dBuV/m)	Margin (dB)	Antenna Height (m)	Table Angle (Degree)	Raw Value (dBuV)	Correction Factor (dB/m)
1	#5620.26	53.3 PK	68.2	-14.9	2.06 H	110	51.2	2.1
2	*5745.00	121.2 PK			2.06 H	110	118.8	2.4
3	*5745.00	110.9 AV			2.06 H	110	108.5	2.4
4	#5931.05	51.4 PK	68.2	-16.8	2.06 H	110	48.5	2.9
5	11490.00	47.4 PK	74.0	-26.6	1.60 H	326	34.8	12.6
6	11490.00	36.3 AV	54.0	-17.7	1.60 H	326	23.7	12.6
7	#17235.00	58.2 PK	68.2	-10.0	1.18 H	294	41.4	16.8

Antenna Polarity & Test Distance : Vertical at 3 m

No	Frequency (MHz)	Emission Level (dBuV/m)	Limit (dBuV/m)	Margin (dB)	Antenna Height (m)	Table Angle (Degree)	Raw Value (dBuV)	Correction Factor (dB/m)
1	#5587.12	50.1 PK	68.2	-18.1	1.97 V	127	48.0	2.1
2	*5745.00	114.9 PK			1.97 V	127	112.5	2.4
3	*5745.00	103.8 AV			1.97 V	127	101.4	2.4
4	#6000.87	51.6 PK	68.2	-16.6	1.97 V	127	48.7	2.9
5	11490.00	47.5 PK	74.0	-26.5	2.82 V	267	34.9	12.6
6	11490.00	36.9 AV	54.0	-17.1	2.82 V	267	24.3	12.6
7	#17235.00	58.4 PK	68.2	-9.8	1.49 V	247	41.6	16.8

Remarks:

1. Emission Level(dBuV/m) = Raw Value(dBuV) + Correction Factor(dB/m)
2. Correction Factor(dB/m) = Antenna Factor(dB/m) + Cable Factor(dB) – Pre-Amplifier Factor(dB)
3. Margin value = Emission Level – Limit value
4. The other emission levels were very low against the limit.
5. " * ": Fundamental frequency.
6. " # ": The radiated frequency is out of the restricted band.

RF Mode	TX 20MHz Preamble 802.11ax (RU106)	Channel	CH 157 : 5785 MHz
Frequency Range	1GHz ~ 40GHz	Detector Function	Peak (PK) Average (AV)

Antenna Polarity & Test Distance : Horizontal at 3 m

No	Frequency (MHz)	Emission Level (dBuV/m)	Limit (dBuV/m)	Margin (dB)	Antenna Height (m)	Table Angle (Degree)	Raw Value (dBuV)	Correction Factor (dB/m)
1	#5623.00	52.5 PK	68.2	-15.7	2.07 H	123	50.4	2.1
2	*5785.00	121.0 PK			2.07 H	123	118.4	2.6
3	*5785.00	110.8 AV			2.07 H	123	108.2	2.6
4	#6005.94	52.0 PK	68.2	-16.2	2.07 H	123	49.1	2.9
5	11570.00	47.5 PK	74.0	-26.5	1.50 H	354	34.9	12.6
6	11570.00	36.3 AV	54.0	-17.7	1.50 H	354	23.7	12.6
7	#17355.00	59.9 PK	68.2	-8.3	1.02 H	277	42.2	17.7

Antenna Polarity & Test Distance : Vertical at 3 m

No	Frequency (MHz)	Emission Level (dBuV/m)	Limit (dBuV/m)	Margin (dB)	Antenna Height (m)	Table Angle (Degree)	Raw Value (dBuV)	Correction Factor (dB/m)
1	#5646.86	50.4 PK	68.2	-17.8	1.98 V	132	48.1	2.3
2	*5785.00	114.5 PK			1.98 V	132	111.9	2.6
3	*5785.00	103.6 AV			1.98 V	132	101.0	2.6
4	#5993.97	51.2 PK	68.2	-17.0	1.98 V	132	48.3	2.9
5	11570.00	48.1 PK	74.0	-25.9	2.78 V	264	35.5	12.6
6	11570.00	37.4 AV	54.0	-16.6	2.78 V	264	24.8	12.6
7	#17355.00	57.1 PK	68.2	-11.1	1.51 V	257	39.4	17.7

Remarks:

1. Emission Level(dBuV/m) = Raw Value(dBuV) + Correction Factor(dB/m)
2. Correction Factor(dB/m) = Antenna Factor(dB/m) + Cable Factor(dB) – Pre-Amplifier Factor(dB)
3. Margin value = Emission Level – Limit value
4. The other emission levels were very low against the limit.
5. " * ": Fundamental frequency.
6. " # ": The radiated frequency is out of the restricted band.

RF Mode	TX 20MHz Preamble 802.11ax (RU106)	Channel	CH 165 : 5825 MHz
Frequency Range	1GHz ~ 40GHz	Detector Function	Peak (PK) Average (AV)

Antenna Polarity & Test Distance : Horizontal at 3 m

No	Frequency (MHz)	Emission Level (dBuV/m)	Limit (dBuV/m)	Margin (dB)	Antenna Height (m)	Table Angle (Degree)	Raw Value (dBuV)	Correction Factor (dB/m)
1	#5581.55	53.7 PK	68.2	-14.5	2.10 H	102	51.6	2.1
2	*5825.00	121.6 PK			2.10 H	102	119.0	2.6
3	*5825.00	111.3 AV			2.10 H	102	108.7	2.6
4	#5933.57	51.9 PK	68.2	-16.3	2.10 H	102	49.0	2.9
5	11650.00	47.8 PK	74.0	-26.2	1.57 H	329	35.6	12.2
6	11650.00	36.5 AV	54.0	-17.5	1.57 H	329	24.3	12.2
7	#17475.00	58.2 PK	68.2	-10.0	1.17 H	292	39.5	18.7

Antenna Polarity & Test Distance : Vertical at 3 m

No	Frequency (MHz)	Emission Level (dBuV/m)	Limit (dBuV/m)	Margin (dB)	Antenna Height (m)	Table Angle (Degree)	Raw Value (dBuV)	Correction Factor (dB/m)
1	#5577.50	51.1 PK	68.2	-17.1	2.03 V	130	49.0	2.1
2	*5825.00	114.9 PK			2.03 V	130	112.3	2.6
3	*5825.00	104.2 AV			2.03 V	130	101.6	2.6
4	#5957.59	51.1 PK	68.2	-17.1	2.03 V	130	48.2	2.9
5	11650.00	48.7 PK	74.0	-25.3	2.78 V	248	36.5	12.2
6	11650.00	37.7 AV	54.0	-16.3	2.78 V	248	25.5	12.2
7	#17475.00	57.4 PK	68.2	-10.8	1.49 V	274	38.7	18.7

Remarks:

1. Emission Level(dBuV/m) = Raw Value(dBuV) + Correction Factor(dB/m)
2. Correction Factor(dB/m) = Antenna Factor(dB/m) + Cable Factor(dB) – Pre-Amplifier Factor(dB)
3. Margin value = Emission Level – Limit value
4. The other emission levels were very low against the limit.
5. " * ": Fundamental frequency.
6. " # ": The radiated frequency is out of the restricted band.

Below 1GHz Data:

RF Mode	TX 802.11a	Channel	CH 157 : 5785 MHz
Frequency Range	9kHz ~ 1GHz	Detector Function	Quasi-Peak (QP)

Antenna Polarity & Test Distance : Horizontal at 3 m								
No	Frequency (MHz)	Emission Level (dBuV/m)	Limit (dBuV/m)	Margin (dB)	Antenna Height (m)	Table Angle (Degree)	Raw Value (dBuV)	Correction Factor (dB/m)
1	120.23	38.5 QP	43.5	-5.0	3.00 H	339	53.5	-15.0
2	166.32	34.6 QP	43.5	-8.9	2.00 H	147	47.7	-13.1
3	226.55	33.7 QP	46.0	-12.3	2.00 H	125	49.6	-15.9
4	298.69	34.8 QP	46.0	-11.2	1.50 H	77	47.1	-12.3
5	336.42	33.7 QP	46.0	-12.3	1.50 H	339	45.0	-11.3
6	575.10	26.7 QP	46.0	-19.3	1.50 H	111	32.9	-6.2

Remarks:

1. Emission Level(dBuV/m) = Raw Value(dBuV) + Correction Factor(dB/m)
2. Correction Factor(dB/m) = Antenna Factor(dB/m) + Cable Factor(dB) – Pre-Amplifier Factor(dB)
3. Margin value = Emission Level – Limit value
4. The other emission levels were very low against the limit of frequency range 30MHz~1000MHz.
5. The emission levels were very low against the limit of frequency range 9kHz~30MHz: the amplitude of spurious emissions attenuated more than 20 dB below the permissible value to be report.

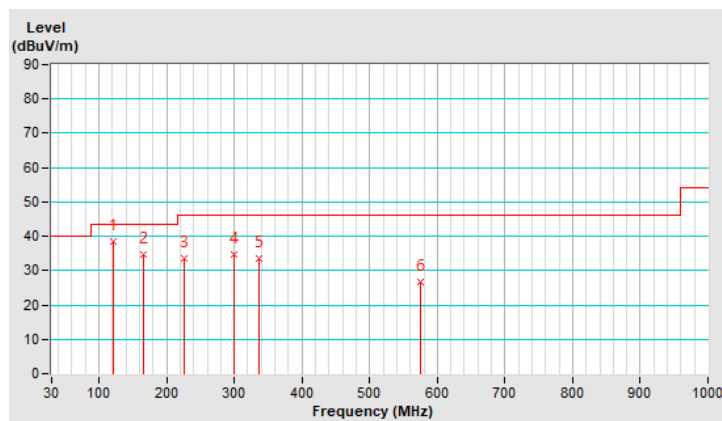

RF Mode	TX 802.11a	Channel	CH 157 : 5785 MHz
Frequency Range	9kHz ~ 1GHz	Detector Function	Quasi-Peak (QP)

Antenna Polarity & Test Distance : Vertical at 3 m

No	Frequency (MHz)	Emission Level (dBuV/m)	Limit (dBuV/m)	Margin (dB)	Antenna Height (m)	Table Angle (Degree)	Raw Value (dBuV)	Correction Factor (dB/m)
1	125.55	28.5 QP	43.5	-15.0	1.00 V	43	43.0	-14.5
2	167.13	32.4 QP	43.5	-11.1	1.50 V	234	45.5	-13.1
3	223.46	31.4 QP	46.0	-14.6	1.00 V	138	47.4	-16.0
4	340.49	26.5 QP	46.0	-19.5	1.50 V	172	37.8	-11.3
5	498.55	24.5 QP	46.0	-21.5	1.50 V	37	32.2	-7.7
6	950.51	33.0 QP	46.0	-13.0	1.00 V	126	33.6	-0.6

Remarks:

1. Emission Level(dBuV/m) = Raw Value(dBuV) + Correction Factor(dB/m)
2. Correction Factor(dB/m) = Antenna Factor(dB/m) + Cable Factor(dB) – Pre-Amplifier Factor(dB)
3. Margin value = Emission Level – Limit value
4. The other emission levels were very low against the limit of frequency range 30MHz~1000MHz.
5. The emission levels were very low against the limit of frequency range 9kHz~30MHz: the amplitude of spurious emissions attenuated more than 20 dB below the permissible value to be report.

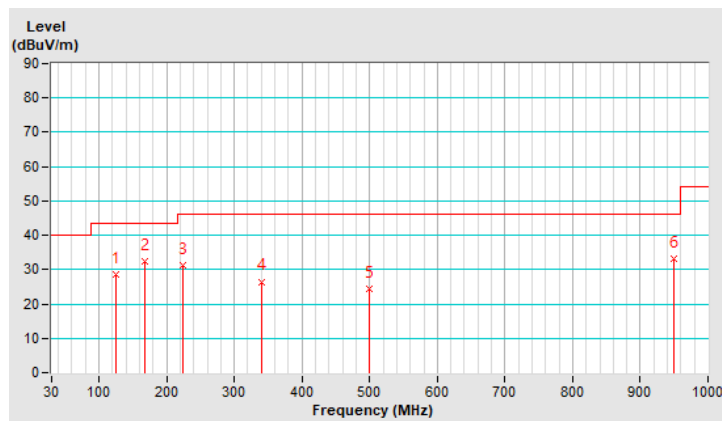

4.2 Conducted Emission Measurement

4.2.1 Limits of Conducted Emission Measurement

Frequency (MHz)	Conducted Limit (dBuV)	
	Quasi-peak	Average
0.15 - 0.5	66 - 56	56 - 46
0.50 - 5.0	56	46
5.0 - 30.0	60	50

Note: 1. The lower limit shall apply at the transition frequencies.

2. The limit decreases in line with the logarithm of the frequency in the range of 0.15 to 0.50MHz.

4.2.2 Test Instruments

DESCRIPTION & MANUFACTURER	MODEL NO.	SERIAL NO.	CALIBRATED DATE	CALIBRATED UNTIL
Test Receiver R&S	ESCS 30	847124/029	Oct. 20, 2020	Oct. 19, 2021
Line-Impedance Stabilization Network (for EUT) R&S	ESH3-Z5	848773/004	Oct. 27, 2020	Oct. 26, 2021
Line-Impedance Stabilization Network (for Peripheral) R&S	ESH3-Z5	835239/001	Mar. 26, 2021	Mar. 25, 2022
50 ohms Terminator	50	3	Oct. 26, 2020	Oct. 25, 2021
RF Cable	5D-FB	COCCAB-001	Sep. 26, 2020	Sep. 25, 2021
Fixed attenuator EMCI	STI02-2200-10	005	Aug. 29, 2020	Aug. 28, 2021
Software BVADT	BVADT_Cond_ V7.3.7.4	NA	NA	NA

Note:

1. The calibration interval of the above test instruments are 12 months and the calibrations are traceable to NML/ROC and NIST/USA.
2. The test was performed in Conduction 1.
- 3 Tested Date: June 21 to July 08, 2021

4.2.3 Test Procedure

- The EUT was placed 0.4 meters from the conducting wall of the shielded room with EUT being connected to the power mains through a line impedance stabilization network (LISN). Other support units were connected to the power mains through another LISN. The two LISNs provide 50 ohm/ 50uH of coupling impedance for the measuring instrument.
- Both lines of the power mains connected to the EUT were checked for maximum conducted interference.
- The frequency range from 150kHz to 30MHz was searched. Emission levels under (Limit - 20dB) was not recorded.

Note: All modes of operation were investigated and the worst-case emissions are reported.

4.2.4 Deviation from Test Standard

No deviation.

4.2.5 Test Setup

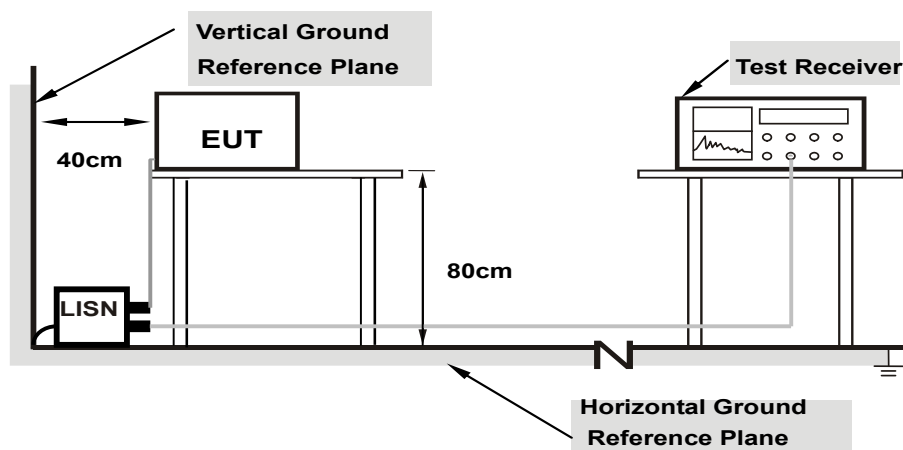

Note: 1.Support units were connected to second LISN.

For the actual test configuration, please refer to the attached file (Test Setup Photo).

4.2.6 EUT Operating Condition

Same as 4.1.6.

4.2.7 Test Results

RF Mode	TX 802.11a	Channel	CH 157 : 5785 MHz
Frequency Range	150kHz ~ 30MHz	Detector Function & Resolution Bandwidth	Quasi-Peak (QP) / Average (AV), 9kHz

Phase Of Power : Line (L)										
No	Frequency (MHz)	Correction Factor (dB)	Reading Value (dBuV)		Emission Level (dBuV)		Limit (dBuV)		Margin (dB)	
			Q.P.	AV.	Q.P.	AV.	Q.P.	AV.	Q.P.	AV.
1	0.15000	9.95	38.53	17.85	48.48	27.80	66.00	56.00	-17.52	-28.20
2	0.16172	9.95	37.51	18.06	47.46	28.01	65.38	55.38	-17.92	-27.37
3	0.18125	9.96	35.60	17.72	45.56	27.68	64.43	54.43	-18.87	-26.75
4	0.22812	9.97	29.05	14.20	39.02	24.17	62.52	52.52	-23.50	-28.35
5	0.27500	9.98	22.21	6.87	32.19	16.85	60.97	50.97	-28.78	-34.12
6	25.87109	11.24	24.23	24.05	35.47	35.29	60.00	50.00	-24.53	-14.71

Remarks:

1. Q.P. and AV. are abbreviations of quasi-peak and average individually.
2. The emission levels of other frequencies were very low against the limit.
3. Margin value = Emission level – Limit value
4. Correction factor = Insertion loss + Cable loss
5. Emission Level = Correction Factor + Reading Value

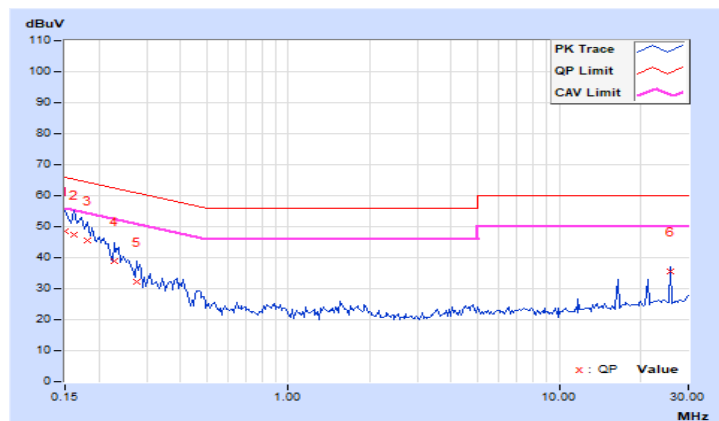

RF Mode	TX 802.11a	Channel	CH 157 : 5785 MHz
Frequency Range	150kHz ~ 30MHz	Detector Function & Resolution Bandwidth	Quasi-Peak (QP) / Average (AV), 9kHz

Phase Of Power : Neutral (N)										
No	Frequency (MHz)	Correction Factor (dB)	Reading Value (dBuV)		Emission Level (dBuV)		Limit (dBuV)		Margin (dB)	
			Q.P.	AV.	Q.P.	AV.	Q.P.	AV.	Q.P.	AV.
1	0.15781	9.92	40.95	19.80	50.87	29.72	65.58	55.58	-14.71	-25.86
2	0.18906	9.94	39.30	19.95	49.24	29.89	64.08	54.08	-14.84	-24.19
3	0.23203	9.95	29.78	16.85	39.73	26.80	62.38	52.38	-22.65	-25.58
4	0.27109	9.95	23.93	9.41	33.88	19.36	61.08	51.08	-27.20	-31.72
5	0.38828	9.96	18.92	6.12	28.88	16.08	58.10	48.10	-29.22	-32.02
6	25.87500	10.91	24.86	24.57	35.77	35.48	60.00	50.00	-24.23	-14.52

Remarks:

1. Q.P. and AV. are abbreviations of quasi-peak and average individually.
2. The emission levels of other frequencies were very low against the limit.
3. Margin value = Emission level – Limit value
4. Correction factor = Insertion loss + Cable loss
5. Emission Level = Correction Factor + Reading Value

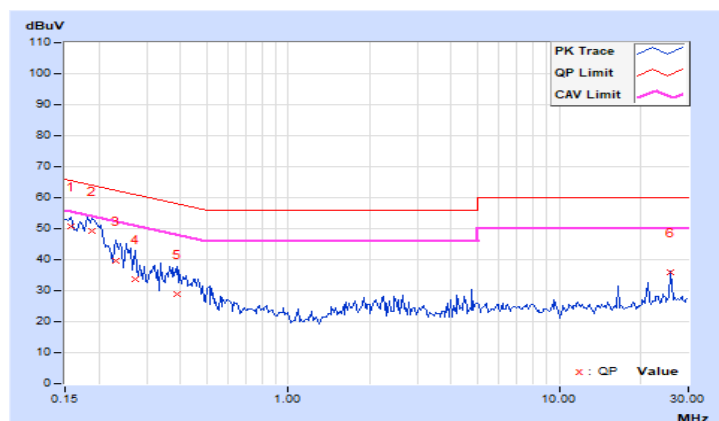

4.3 Transmit Power Measurement

4.3.1 Limits of Transmit Power Measurement

Operation Band	EUT Category		Limit
U-NII-1		Outdoor Access Point	1 Watt (30 dBm) (Max. e.i.r.p \leq 125mW(21 dBm) at any elevation angle above 30 degrees as measured from the horizon)
		Fixed point-to-point Access Point	1 Watt (30 dBm)
		Indoor Access Point	1 Watt (30 dBm)
	√	Client device	250mW (24 dBm)
U-NII-2A		√	250mW (24 dBm) or 11 dBm+10 log B*
U-NII-2C		√	250mW (24 dBm) or 11 dBm+10 log B*
U-NII-3		√	1 Watt (30 dBm)

*B is the 26 dB emission bandwidth in megahertz

Per KDB 662911 Method of conducted output power measurement on IEEE 802.11 devices,

Array Gain = 0 dB (i.e., no array gain) for $N_{ANT} \leq 4$;

Array Gain = 0 dB (i.e., no array gain) for channel widths ≥ 40 MHz for any N_{ANT} ;

Array Gain = $5 \log(N_{ANT}/N_{SS})$ dB or 3 dB, whichever is less for 20-MHz channel widths with $N_{ANT} \geq 5$.

For power measurements on all other devices: Array Gain = $10 \log(N_{ANT}/N_{SS})$ dB.

4.3.2 Test Setup

FOR POWER OUTPUT MEASUREMENT

For channel straddling 5725MHz:

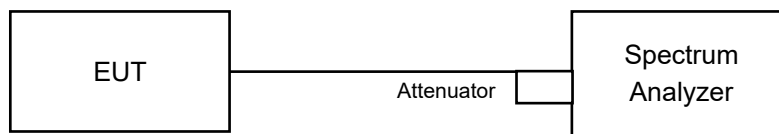

For other channels:

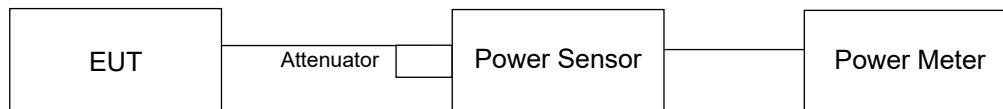

FOR 26dB OCCUPIED BANDWIDTH

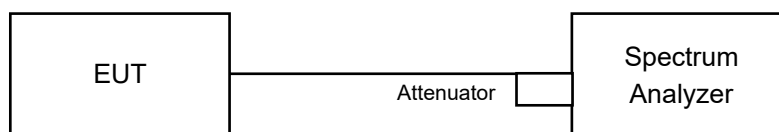

4.3.3 Test Instruments

Refer to section 4.1.2 to get information of above instrument.

4.3.4 Test Procedure

FOR POWER OUTPUT MEASUREMENT

For channel straddling 5725MHz:

Follow FCC KDB 789033 UNII test procedure:

Method SA-2

1. Set span to encompass the emission bandwidth (EBW) of the signal.
2. Set RBW = 1MHz.
3. Set the VBW $\geq 3 \times$ RBW.
4. Number of points in sweep ≥ 2 Span / RBW.
5. Sweep time = auto.
6. Detector = RMS.
7. Trace average at least 100 traces in power averaging mode
8. Compute power by integrating the spectrum across the 26 dB EBW of the signal.
9. Duty factor need added to measured value (duty cycle < 98 percent).

For other channels:

Method PM is used to perform output power measurement, trigger and gating function of wide band power meter is enabled to measure max output power of TX on burst. Duty factor is not added to measured value.

FOR 26dB OCCUPIED BANDWIDTH

1. Set RBW = approximately 1% of the emission bandwidth.
2. Set the VBW > RBW.
3. Detector = Peak.
4. Trace mode = max hold.
5. Measure the maximum width of the emission that is 26 dB down from the peak of the emission. Compare this with the RBW setting of the analyzer. Readjust RBW and repeat measurement as needed until the RBW/EBW ratio is approximately 1%.

4.3.5 Deviation from Test Standard

No deviation.

4.3.6 EUT Operating Condition

The software provided by client to enable the EUT under transmission condition continuously at lowest, middle and highest channel frequencies individually.

4.3.7 Test Results (Mode 1)

POWER OUTPUT
CDD Mode
802.11a

Chan.	Chan. Freq. (MHz)	Average Power (dBm)		Total Power (mW)	Total Power (dBm)	Limit (dBm)	Pass / Fail
		Chain 0	Chain 1				
36	5180	18.87	18.74	151.907	21.82	24	Pass
40	5200	18.80	18.72	150.331	21.77	24	Pass
48	5240	18.86	18.65	150.195	21.77	24	Pass
52	5260	18.99	18.83	155.634	21.92	23.59	Pass
60	5300	19.01	18.85	156.352	21.94	23.58	Pass
64	5320	18.91	18.82	154.012	21.88	23.57	Pass
100	5500	18.23	18.06	130.501	21.16	23.57	Pass
116	5580	18.84	18.92	154.543	21.89	23.58	Pass
140	5700	17.98	18.31	130.57	21.16	23.58	Pass
*144 (U-NII-2C Band)	5720	17.32	17.67	112.43	20.51	22.54	Pass
*144 (U-NII-3 Band)	5720	8.71	9.23	15.805	11.99	30	Pass
149	5745	21.76	22.21	316.31	25.00	30	Pass
157	5785	22.34	22.47	348	25.42	30	Pass
165	5825	21.75	22.22	316.348	25.00	30	Pass

Note: * Test was performed in accordance with Measurement follow FCC KDB 789033 UNII test procedure Method SA-1 and use spectrum analyzer test.

Note: For U-NII-2A, U-NII-2C Band output power limitation is determined based on 26dBc bandwidth

Power Limit = 11dBm + 10logB < U-NII-2A, U-NII-2C >			
Channel Number	Freq.(MHz)	Min. B(MHz)	Determined Conducted Limit (dBm)
52	5260	18.17	23.59 < 24
60	5300	18.14	23.58 < 24
64	5320	18.1	23.57 < 24
100	5500	18.09	23.57 < 24
116	5580	18.15	23.58 < 24
140	5700	18.13	23.58 < 24
144 (U-NII-2C Band)	5720	14.26	22.54 < 24

802.11ac (VHT20)

Chan.	Chan. Freq. (MHz)	Average Power (dBm)		Total Power (mW)	Total Power (dBm)	Limit (dBm)	Pass / Fail
		Chain 0	Chain 1				
36	5180	19.03	18.74	154.8	21.90	24	Pass
40	5200	19.10	18.79	156.966	21.96	24	Pass
48	5240	19.08	18.73	155.554	21.92	24	Pass
52	5260	18.99	18.90	156.875	21.96	24	Pass
60	5300	19.01	18.88	156.884	21.96	24	Pass
64	5320	19.11	18.79	157.154	21.96	24	Pass
100	5500	18.39	18.35	137.415	21.38	24	Pass
116	5580	18.91	18.91	155.607	21.92	24	Pass
140	5700	18.14	18.20	131.232	21.18	24	Pass
*144 (U-NII-2C Band)	5720	16.92	17.60	106.748	20.28	22.82	Pass
*144 (U-NII-3 Band)	5720	9.00	9.82	17.537	12.44	30	Pass
149	5745	21.62	22.02	304.432	24.83	30	Pass
157	5785	21.47	21.99	298.406	24.75	30	Pass
165	5825	21.47	21.93	296.237	24.72	30	Pass

Note: * Test was performed in accordance with Measurement follow FCC KDB 789033 UNII test procedure Method SA-1 and use spectrum analyzer test.

Note: For U-NII-2A, U-NII-2C Band output power limitation is determined based on 26dBc bandwidth

Power Limit = 11dBm + 10logB < U-NII-2A, U-NII-2C >			
Channel Number	Freq.(MHz)	Min. B(MHz)	Determined Conducted Limit (dBm)
52	5260	20.34	24.08 > 24
60	5300	20.33	24.08 > 24
64	5320	20.32	24.07 > 24
100	5500	20.31	24.07 > 24
116	5580	20.32	24.07 > 24
140	5700	20.31	24.07 > 24
144 (U-NII-2C Band)	5720	15.21	22.82 < 24

802.11ac (VHT40)

Chan.	Chan. Freq. (MHz)	Average Power (dBm)		Total Power (mW)	Total Power (dBm)	Limit (dBm)	Pass / Fail
		Chain 0	Chain 1				
38	5190	16.57	16.55	90.58	19.57	24	Pass
46	5230	20.69	20.61	232.3	23.66	24	Pass
54	5270	20.54	20.92	236.835	23.74	24	Pass
62	5310	16.50	16.74	91.875	19.63	24	Pass
102	5510	15.17	15.27	66.536	18.23	24	Pass
110	5550	20.43	20.83	231.468	23.64	24	Pass
134	5670	18.51	18.61	143.568	21.57	24	Pass
*142 (U-NII-2C Band)	5710	19.34	19.95	184.757	22.67	24	Pass
*142 (U-NII-3 Band)	5710	6.21	6.52	8.666	9.38	30	Pass
151	5755	20.65	21.05	243.495	23.86	30	Pass
159	5795	20.58	21.06	241.932	23.84	30	Pass

Note: * Test was performed in accordance with Measurement follow FCC KDB 789033 UNII test procedure Method SA-1 and use spectrum analyzer test.

Note: For U-NII-2A, U-NII-2C Band output power limitation is determined based on 26dBc bandwidth

Power Limit = 11dBm + 10logB < U-NII-2A, U-NII-2C >			
Channel Number	Freq.(MHz)	Min. B(MHz)	Determined Conducted Limit (dBm)
54	5270	51.5	28.11 > 24
62	5310	40.77	27.1 > 24
102	5510	40.71	27.09 > 24
110	5550	44.88	27.52 > 24
134	5670	40.76	27.1 > 24
142 (U-NII-2C Band)	5710	37.86	26.78 > 24

802.11ac (VHT80)

Chan.	Chan. Freq. (MHz)	Average Power (dBm)		Total Power (mW)	Total Power (dBm)	Limit (dBm)	Pass / Fail
		Chain 0	Chain 1				
42	5210	15.56	15.43	70.889	18.51	24	Pass
58	5290	16.86	16.62	94.449	19.75	24	Pass
106	5530	15.35	15.29	68.083	18.33	24	Pass
122	5610	18.86	19.10	158.196	21.99	24	Pass
*138 (U-NII-2C Band)	5690	18.96	19.29	163.623	22.14	24	Pass
*138 (U-NII-3 Band)	5690	4.44	4.82	5.814	7.64	30	Pass
155	5775	20.06	20.43	211.799	23.26	30	Pass

Note: * Test was performed in accordance with Measurement follow FCC KDB 789033 UNII test procedure Method SA-1 and use spectrum analyzer test.

Note: For U-NII-2A, U-NII-2C Band output power limitation is determined based on 26dBc bandwidth

Power Limit = 11dBm + 10logB < U-NII-2A, U-NII-2C >			
Channel Number	Freq.(MHz)	Min. B(MHz)	Determined Conducted Limit (dBm)
58	5290	82.17	30.14 > 24
106	5530	82.24	30.15 > 24
122	5610	82.33	30.15 > 24
138 (U-NII-2C Band)	5690	76.21	29.82 > 24

802.11ax (HE20)

Chan.	Chan. Freq. (MHz)	Average Power (dBm)		Total Power (mW)	Total Power (dBm)	Limit (dBm)	Pass / Fail
		Chain 0	Chain 1				
36	5180	19.32	19.01	165.123	22.18	24	Pass
40	5200	19.34	19.10	167.184	22.23	24	Pass
48	5240	19.35	19.01	165.715	22.19	24	Pass
52	5260	19.27	19.11	165.998	22.20	24	Pass
60	5300	19.26	19.08	165.243	22.18	24	Pass
64	5320	19.33	19.03	165.687	22.19	24	Pass
100	5500	18.64	18.62	145.892	21.64	24	Pass
116	5580	19.11	19.19	164.456	22.16	24	Pass
140	5700	18.32	18.38	136.786	21.36	24	Pass
*144 (U-NII-2C Band)	5720	17.46	17.86	116.813	20.67	22.82	Pass
*144 (U-NII-3 Band)	5720	9.61	10.10	19.374	12.87	30	Pass
149	5745	21.83	22.25	320.286	25.06	30	Pass
157	5785	21.75	22.21	315.965	25.00	30	Pass
165	5825	21.72	22.22	315.318	24.99	30	Pass

Note: * Test was performed in accordance with Measurement follow FCC KDB 789033 UNII test procedure Method SA-1 and use spectrum analyzer test.

Note: For U-NII-2A, U-NII-2C Band output power limitation is determined based on 26dBc bandwidth

Power Limit = 11dBm + 10logB < U-NII-2A, U-NII-2C >			
Channel Number	Freq.(MHz)	Min. B(MHz)	Determined Conducted Limit (dBm)
52	5260	20.34	24.08 > 24
60	5300	20.33	24.08 > 24
64	5320	20.32	24.07 > 24
100	5500	20.31	24.07 > 24
116	5580	20.32	24.07 > 24
140	5700	20.31	24.07 > 24
144 (U-NII-2C Band)	5720	15.21	22.82 < 24

802.11ax (HE40)

Chan.	Chan. Freq. (MHz)	Average Power (dBm)		Total Power (mW)	Total Power (dBm)	Limit (dBm)	Pass / Fail
		Chain 0	Chain 1				
38	5190	16.84	16.77	95.839	19.82	24	Pass
46	5230	20.94	20.90	247.192	23.93	24	Pass
54	5270	20.75	21.13	248.568	23.95	24	Pass
62	5310	16.79	16.96	97.412	19.89	24	Pass
102	5510	15.41	15.52	70.399	18.48	24	Pass
110	5550	20.69	21.06	244.863	23.89	24	Pass
134	5670	18.66	18.76	148.614	21.72	24	Pass
*142 (U-NII-2C Band)	5710	19.55	20.16	193.91	22.88	24	Pass
*142 (U-NII-3 Band)	5710	6.43	7.13	9.56	9.80	30	Pass
151	5755	20.87	21.30	257.076	24.10	30	Pass
159	5795	20.84	21.31	256.546	24.09	30	Pass

Note: * Test was performed in accordance with Measurement follow FCC KDB 789033 UNII test procedure Method SA-1 and use spectrum analyzer test.

Note: For U-NII-2A, U-NII-2C Band output power limitation is determined based on 26dBc bandwidth

Power Limit = 11dBm + 10logB < U-NII-2A, U-NII-2C >			
Channel Number	Freq.(MHz)	Min. B(MHz)	Determined Conducted Limit (dBm)
54	5270	51.5	28.11 > 24
62	5310	40.77	27.1 > 24
102	5510	40.71	27.09 > 24
110	5550	44.88	27.52 > 24
134	5670	40.76	27.1 > 24
142 (U-NII-2C Band)	5710	37.86	26.78 > 24

802.11ax (HE80)

Chan.	Chan. Freq. (MHz)	Average Power (dBm)		Total Power (mW)	Total Power (dBm)	Limit (dBm)	Pass / Fail
		Chain 0	Chain 1				
42	5210	15.76	15.67	74.568	18.73	24	Pass
58	5290	17.07	16.89	99.798	19.99	24	Pass
106	5530	15.52	15.46	70.801	18.50	24	Pass
122	5610	19.11	19.31	166.78	22.22	24	Pass
*138 (U-NII-2C Band)	5690	19.12	19.57	172.231	22.36	24	Pass
*138 (U-NII-3 Band)	5690	4.75	5.05	6.184	7.91	30	Pass
155	5775	20.26	20.72	224.202	23.51	30	Pass

Note: * Test was performed in accordance with Measurement follow FCC KDB 789033 UNII test procedure Method SA-1 and use spectrum analyzer test.

Note: For U-NII-2A, U-NII-2C Band output power limitation is determined based on 26dBc bandwidth

Power Limit = 11dBm + 10logB < U-NII-2A, U-NII-2C >			
Channel Number	Freq.(MHz)	Min. B(MHz)	Determined Conducted Limit (dBm)
58	5290	82.17	30.14 > 24
106	5530	82.24	30.15 > 24
122	5610	82.33	30.15 > 24
138 (U-NII-2C Band)	5690	76.21	29.82 > 24

802.11ax (RU26)

RU Configuration	Chan.	Chan. Freq. (MHz)	Average Power (dBm)		Total Power (mW)	Total Power (dBm)	Limit (dBm)	Pass / Fail
			Chain 0	Chain 1				
26/0	36	5180	9.32	9.81	18.123	12.58	24	Pass
26/4	40	5200	10.61	10.52	22.78	13.58	24	Pass
26/8	48	5240	9.42	9.83	18.366	12.64	24	Pass
26/0	52	5260	9.53	9.92	18.792	12.74	23.88	Pass
26/4	60	5300	10.69	10.53	23.02	13.62	23.45	Pass
26/8	64	5320	9.44	9.85	18.451	12.66	23.87	Pass
26/0	100	5500	9.75	9.81	19.013	12.79	23.88	Pass
26/4	116	5580	11.04	10.43	23.747	13.76	23.46	Pass
26/8	140	5700	9.64	9.99	19.181	12.83	23.88	Pass
26/8	*144 (U-NII-2 C Band)	5720	-18.34	-16.41	0.03751	-14.26	22.5	Pass
26/8	*144 (U-NII-3 Band)	5720	9.62	11.27	22.559	13.53	30	Pass
26/0	*144 (U-NII-2 C Band)	5720	9.60	11.06	21.884	13.40	22.86	Pass
26/0	*144 (U-NII-3 Band)	5720	-35.71	-33.40	0.0007256	-31.39	30	Pass
26/0	149	5745	21.47	21.67	287.174	24.58	30	Pass
26/4	157	5785	21.72	21.86	302.055	24.80	30	Pass
26/8	165	5825	21.53	21.75	291.856	24.65	30	Pass

Note: * Test was performed in accordance with Measurement follow FCC KDB 789033 UNII test procedure Method SA-1 and use spectrum analyzer test.

Note: For U-NII-2A, U-NII-2C Band output power limitation is determined based on 26dBc bandwidth

Power Limit = 11dBm + 10logB < U-NII-2A, U-NII-2C >			
Channel Number	Freq.(MHz)	Min. B(MHz)	Determined Conducted Limit (dBm)
52	5260	19.43	23.88 < 24
60	5300	17.61	23.45 < 24
64	5320	19.37	23.87 < 24
100	5500	19.42	23.88 < 24
116	5580	17.65	23.46 < 24
140	5700	19.42	23.88 < 24
144 (U-NII-2C Band)	5720	14.13	22.5 < 24
144 (U-NII-2C Band)	5720	15.38	22.86 < 24

802.11ax (RU52)

RU Configuration	Chan.	Chan. Freq. (MHz)	Average Power (dBm)		Total Power (mW)	Total Power (dBm)	Limit (dBm)	Pass / Fail
			Chain 0	Chain 1				
52/37	36	5180	11.44	11.92	29.491	14.70	24	Pass
52/39	40	5200	12.06	12.64	34.435	15.37	24	Pass
52/40	48	5240	11.34	11.74	28.542	14.55	24	Pass
52/37	52	5260	11.42	12.89	33.321	15.23	23.85	Pass
52/39	60	5300	12.23	12.92	36.299	15.60	23.59	Pass
52/40	64	5320	11.41	11.69	28.593	14.56	23.9	Pass
52/37	100	5500	11.54	12.01	30.142	14.79	23.85	Pass
52/39	116	5580	12.02	11.61	30.41	14.83	23.59	Pass
52/40	140	5700	10.95	11.16	25.507	14.07	23.89	Pass
52/40	*144 (U-NII-2 C Band)	5720	-9.91	-8.13	0.2559	-5.92	22.53	Pass
52/40	*144 (U-NII-3 Band)	5720	10.34	12.27	27.68	14.42	30	Pass
52/37	*144 (U-NII-2 C Band)	5720	13.22	12.29	37.933	15.79	22.81	Pass
52/37	*144 (U-NII-3 Band)	5720	-31.68	-33.52	0.0011238	-29.49	30	Pass
52/37	149	5745	22.27	22.33	339.657	25.31	30	Pass
52/39	157	5785	22.34	22.42	345.978	25.39	30	Pass
52/40	165	5825	22.29	22.39	342.814	25.35	30	Pass

Note: * Test was performed in accordance with Measurement follow FCC KDB 789033 UNII test procedure Method SA-1 and use spectrum analyzer test.

Note: For U-NII-2A, U-NII-2C Band output power limitation is determined based on 26dBc bandwidth

Power Limit = 11dBm + 10logB < U-NII-2A, U-NII-2C >			
Channel Number	Freq.(MHz)	Min. B(MHz)	Determined Conducted Limit (dBm)
52	5260	19.3	23.85 < 24
60	5300	18.19	23.59 < 24
64	5320	19.5	23.9 < 24
100	5500	19.29	23.85 < 24
116	5580	18.17	23.59 < 24
140	5700	19.48	23.89 < 24
144 (U-NII-2C Band)	5720	14.24	22.53 < 24
144 (U-NII-2C Band)	5720	15.2	22.81 < 24

802.11ax (RU106)

RU Configuration	Chan.	Chan. Freq. (MHz)	Average Power (dBm)		Total Power (mW)	Total Power (dBm)	Limit (dBm)	Pass / Fail
			Chain 0	Chain 1				
106/53	36	5180	13.92	13.95	49.492	16.95	24	Pass
106/53	40	5200	13.86	13.98	49.325	16.93	24	Pass
106/54	48	5240	13.89	14.02	49.725	16.97	24	Pass
106/53	52	5260	13.88	13.81	48.478	16.86	23.86	Pass
106/54	60	5300	14.08	14.03	50.879	17.07	23.87	Pass
106/54	64	5320	14.09	13.99	50.706	17.05	23.87	Pass
106/53	100	5500	13.68	13.71	46.831	16.71	23.87	Pass
106/53	116	5580	13.41	13.58	44.731	16.51	23.86	Pass
106/54	140	5700	13.69	13.81	47.432	16.76	23.87	Pass
106/54	*144 (U-NII-2 C Band)	5720	11.36	12.09	29.858	14.75	22.53	Pass
106/54	*144 (U-NII-3 Band)	5720	8.92	9.68	17.088	12.33	30	Pass
106/53	*144 (U-NII-2 C Band)	5720	13.88	13.17	45.183	16.55	22.82	Pass
106/53	*144 (U-NII-3 Band)	5720	-29.23	-30.83	0.00202	-26.95	30	Pass
106/53	149	5745	22.27	22.37	341.239	25.33	30	Pass
106/54	157	5785	22.34	22.46	347.593	25.41	30	Pass
106/54	165	5825	22.29	22.43	344.418	25.37	30	Pass

Note: * Test was performed in accordance with Measurement follow FCC KDB 789033 UNII test procedure Method SA-1 and use spectrum analyzer test.

Note: For U-NII-2A, U-NII-2C Band output power limitation is determined based on 26dBc bandwidth

Power Limit = 11dBm + 10logB < U-NII-2A, U-NII-2C >			
Channel Number	Freq.(MHz)	Min. B(MHz)	Determined Conducted Limit (dBm)
52	5260	19.36	23.86 < 24
60	5300	19.38	23.87 < 24
64	5320	19.39	23.87 < 24
100	5500	19.38	23.87 < 24
116	5580	19.35	23.86 < 24
140	5700	19.38	23.87 < 24
144 (U-NII-2C Band)	5720	14.25	22.53 < 24
144 (U-NII-2C Band)	5720	15.22	22.82 < 24

Beamforming Mode

802.11ac (VHT20)

Chan.	Chan. Freq. (MHz)	Average Power (dBm)		Total Power (mW)	Total Power (dBm)	Limit (dBm)	Pass / Fail
		Chain 0	Chain 1				
36	5180	18.82	18.49	146.84	21.67	21.99	Pass
40	5200	18.84	18.54	148.009	21.70	21.99	Pass
48	5240	18.83	18.51	147.341	21.68	21.99	Pass
52	5260	18.79	18.58	147.794	21.70	21.99	Pass
60	5300	18.81	18.63	148.978	21.73	21.99	Pass
64	5320	18.79	18.54	147.133	21.68	21.99	Pass
100	5500	18.39	18.35	137.415	21.38	21.99	Pass
116	5580	18.56	18.77	147.115	21.68	21.99	Pass
140	5700	18.14	18.20	131.232	21.18	21.99	Pass
*144 (U-NII-2C Band)	5720	16.52	16.90	93.852	19.72	20.81	Pass
*144 (U-NII-3 Band)	5720	8.66	9.13	15.53	11.91	27.99	Pass
149	5745	21.62	22.02	304.432	24.83	27.99	Pass
157	5785	21.47	21.99	298.406	24.75	27.99	Pass
165	5825	21.47	21.93	296.237	24.72	27.99	Pass

Note: * Test was performed in accordance with Measurement follow FCC KDB 789033 UNII test procedure Method SA-1 and use spectrum analyzer test.

1. The directional gain = 5 dBi + 10log(2) = 8.01 dBi > 6 dBi, therefore the limit needs to reduce, so the power limit shall be reduced to "Determined Conducted Limit-(8.01-6)".

Note: For U-NII-2A, U-NII-2C Band output power limitation is determined based on 26dBc bandwidth

Power Limit = 11dBm + 10logB < U-NII-2A, U-NII-2C >			
Channel Number	Freq.(MHz)	Min. B(MHz)	Determined Conducted Limit (dBm)
52	5260	20.34	24.08 > 24
60	5300	20.33	24.08 > 24
64	5320	20.32	24.07 > 24
100	5500	20.31	24.07 > 24
116	5580	20.32	24.07 > 24
140	5700	20.31	24.07 > 24
144 (U-NII-2C Band)	5720	15.21	22.82 < 24

802.11ac (VHT40)

Chan.	Chan. Freq. (MHz)	Average Power (dBm)		Total Power (mW)	Total Power (dBm)	Limit (dBm)	Pass / Fail
		Chain 0	Chain 1				
38	5190	16.57	16.55	90.58	19.57	21.99	Pass
46	5230	18.60	18.68	146.234	21.65	21.99	Pass
54	5270	18.51	18.84	147.517	21.69	21.99	Pass
62	5310	16.50	16.74	91.875	19.63	21.99	Pass
102	5510	15.17	15.27	66.536	18.23	21.99	Pass
110	5550	18.45	18.76	145.146	21.62	21.99	Pass
134	5670	18.51	18.61	143.568	21.57	21.99	Pass
*142 (U-NII-2C Band)	5710	16.98	17.61	107.565	20.32	21.99	Pass
*142 (U-NII-3 Band)	5710	3.97	4.70	5.446	7.36	27.99	Pass
151	5755	20.65	21.05	243.495	23.86	27.99	Pass
159	5795	20.58	21.06	241.932	23.84	27.99	Pass

Note: * Test was performed in accordance with Measurement follow FCC KDB 789033 UNII test procedure Method SA-1 and use spectrum analyzer test.

1. The directional gain = 5 dBi + 10log(2) = 8.01 dBi > 6 dBi, therefore the limit needs to reduce, so the power limit shall be reduced to "Determined Conducted Limit-(8.01-6)".

Note: For U-NII-2A, U-NII-2C Band output power limitation is determined based on 26dBc bandwidth

Power Limit = 11dBm + 10logB < U-NII-2A, U-NII-2C >			
Channel Number	Freq.(MHz)	Min. B(MHz)	Determined Conducted Limit (dBm)
54	5270	51.5	28.11 > 24
62	5310	40.77	27.1 > 24
102	5510	40.71	27.09 > 24
110	5550	44.88	27.52 > 24
134	5670	40.76	27.1 > 24
142 (U-NII-2C Band)	5710	37.86	26.78 > 24

802.11ac (VHT80)

Chan.	Chan. Freq. (MHz)	Average Power (dBm)		Total Power (mW)	Total Power (dBm)	Limit (dBm)	Pass / Fail
		Chain 0	Chain 1				
42	5210	15.56	15.43	70.889	18.51	21.99	Pass
58	5290	16.86	16.62	94.449	19.75	21.99	Pass
106	5530	15.35	15.29	68.083	18.33	21.99	Pass
122	5610	18.61	18.77	147.946	21.70	21.99	Pass
*138 (U-NII-2C Band)	5690	17.11	17.62	109.214	20.38	21.99	Pass
*138 (U-NII-3 Band)	5690	2.85	3.12	3.979	6.00	27.99	Pass
155	5775	20.06	20.43	211.799	23.26	27.99	Pass

Note: * Test was performed in accordance with Measurement follow FCC KDB 789033 UNII test procedure Method SA-1 and use spectrum analyzer test.

1. The directional gain = 5 dBi + 10log(2) = 8.01 dBi > 6 dBi, therefore the limit needs to reduce, so the power limit shall be reduced to "Determined Conducted Limit-(8.01-6)".

Note: For U-NII-2A, U-NII-2C Band output power limitation is determined based on 26dBc bandwidth

Power Limit = 11dBm + 10logB < U-NII-2A, U-NII-2C >			
Channel Number	Freq.(MHz)	Min. B(MHz)	Determined Conducted Limit (dBm)
58	5290	82.17	30.14 > 24
106	5530	82.24	30.15 > 24
122	5610	82.33	30.15 > 24
138 (U-NII-2C Band)	5690	76.21	29.82 > 24

802.11ax (HE20)

Chan.	Chan. Freq. (MHz)	Average Power (dBm)		Total Power (mW)	Total Power (dBm)	Limit (dBm)	Pass / Fail
		Chain 0	Chain 1				
36	5180	19.06	18.76	155.7	21.92	21.99	Pass
40	5200	19.10	18.77	156.619	21.95	21.99	Pass
48	5240	19.09	18.73	155.741	21.92	21.99	Pass
52	5260	19.03	18.83	156.367	21.94	21.99	Pass
60	5300	19.01	18.84	156.176	21.94	21.99	Pass
64	5320	19.06	18.78	156.047	21.93	21.99	Pass
100	5500	18.64	18.62	145.892	21.64	21.99	Pass
116	5580	18.84	18.98	155.628	21.92	21.99	Pass
140	5700	18.32	18.38	136.786	21.36	21.99	Pass
*144 (U-NII-2C Band)	5720	16.78	17.20	100.124	20.01	20.81	Pass
*144 (U-NII-3 Band)	5720	8.83	9.46	16.469	12.17	27.99	Pass
149	5745	21.83	22.25	320.286	25.06	27.99	Pass
157	5785	21.75	22.21	315.965	25.00	27.99	Pass
165	5825	21.72	22.22	315.318	24.99	27.99	Pass

Note: * Test was performed in accordance with Measurement follow FCC KDB 789033 UNII test procedure Method SA-1 and use spectrum analyzer test.

1. The directional gain = 5 dBi + 10log(2) = 8.01 dBi > 6 dBi, therefore the limit needs to reduce, so the power limit shall be reduced to "Determined Conducted Limit-(8.01-6)".

Note: For U-NII-2A, U-NII-2C Band output power limitation is determined based on 26dBc bandwidth

Power Limit = 11dBm + 10logB < U-NII-2A, U-NII-2C >			
Channel Number	Freq.(MHz)	Min. B(MHz)	Determined Conducted Limit (dBm)
52	5260	20.34	24.08 > 24
60	5300	20.33	24.08 > 24
64	5320	20.32	24.07 > 24
100	5500	20.31	24.07 > 24
116	5580	20.32	24.07 > 24
140	5700	20.31	24.07 > 24
144 (U-NII-2C Band)	5720	15.21	22.82 < 24

802.11ax (HE40)

Chan.	Chan. Freq. (MHz)	Average Power (dBm)		Total Power (mW)	Total Power (dBm)	Limit (dBm)	Pass / Fail
		Chain 0	Chain 1				
38	5190	16.84	16.77	95.839	19.82	21.99	Pass
46	5230	18.89	18.93	155.609	21.92	21.99	Pass
54	5270	18.77	19.06	155.873	21.93	21.99	Pass
62	5310	16.79	16.96	97.412	19.89	21.99	Pass
102	5510	15.41	15.52	70.399	18.48	21.99	Pass
110	5550	18.74	19.01	154.433	21.89	21.99	Pass
134	5670	18.66	18.76	148.614	21.72	21.99	Pass
*142 (U-NII-2C Band)	5710	17.32	17.74	113.38	20.55	21.99	Pass
*142 (U-NII-3 Band)	5710	4.26	4.88	5.743	7.59	27.99	Pass
151	5755	20.87	21.30	257.076	24.10	27.99	Pass
159	5795	20.84	21.31	256.546	24.09	27.99	Pass

Note: * Test was performed in accordance with Measurement follow FCC KDB 789033 UNII test procedure Method SA-1 and use spectrum analyzer test.

1. The directional gain = 5 dBi + 10log(2) = 8.01 dBi > 6 dBi, therefore the limit needs to reduce, so the power limit shall be reduced to "Determined Conducted Limit-(8.01-6)".

Note: For U-NII-2A, U-NII-2C Band output power limitation is determined based on 26dBc bandwidth

Power Limit = 11dBm + 10logB < U-NII-2A, U-NII-2C >			
Channel Number	Freq.(MHz)	Min. B(MHz)	Determined Conducted Limit (dBm)
54	5270	51.5	28.11 > 24
62	5310	40.77	27.1 > 24
102	5510	40.71	27.09 > 24
110	5550	44.88	27.52 > 24
134	5670	40.76	27.1 > 24
142 (U-NII-2C Band)	5710	37.86	26.78 > 24

802.11ax (HE80)

Chan.	Chan. Freq. (MHz)	Average Power (dBm)		Total Power (mW)	Total Power (dBm)	Limit (dBm)	Pass / Fail
		Chain 0	Chain 1				
42	5210	15.76	15.67	74.568	18.73	21.99	Pass
58	5290	17.07	16.89	99.798	19.99	21.99	Pass
106	5530	15.52	15.46	70.801	18.50	21.99	Pass
122	5610	18.88	18.98	156.336	21.94	21.99	Pass
*138 (U-NII-2C Band)	5690	17.44	17.88	116.839	20.68	21.99	Pass
*138 (U-NII-3 Band)	5690	3.14	3.35	4.223	6.26	27.99	Pass
155	5775	20.26	20.72	224.202	23.51	27.99	Pass

Note: * Test was performed in accordance with Measurement follow FCC KDB 789033 UNII test procedure Method SA-1 and use spectrum analyzer test.

1. The directional gain = 5 dBi + 10log(2) = 8.01 dBi > 6 dBi, therefore the limit needs to reduce, so the power limit shall be reduced to "Determined Conducted Limit-(8.01-6)".

Note: For U-NII-2A, U-NII-2C Band output power limitation is determined based on 26dBc bandwidth

Power Limit = 11dBm + 10logB < U-NII-2A, U-NII-2C >			
Channel Number	Freq.(MHz)	Min. B(MHz)	Determined Conducted Limit (dBm)
58	5290	82.17	30.14 > 24
106	5530	82.24	30.15 > 24
122	5610	82.33	30.15 > 24
138 (U-NII-2C Band)	5690	76.21	29.82 > 24

For channel straddling 5725MHz of Power
CDD Mode

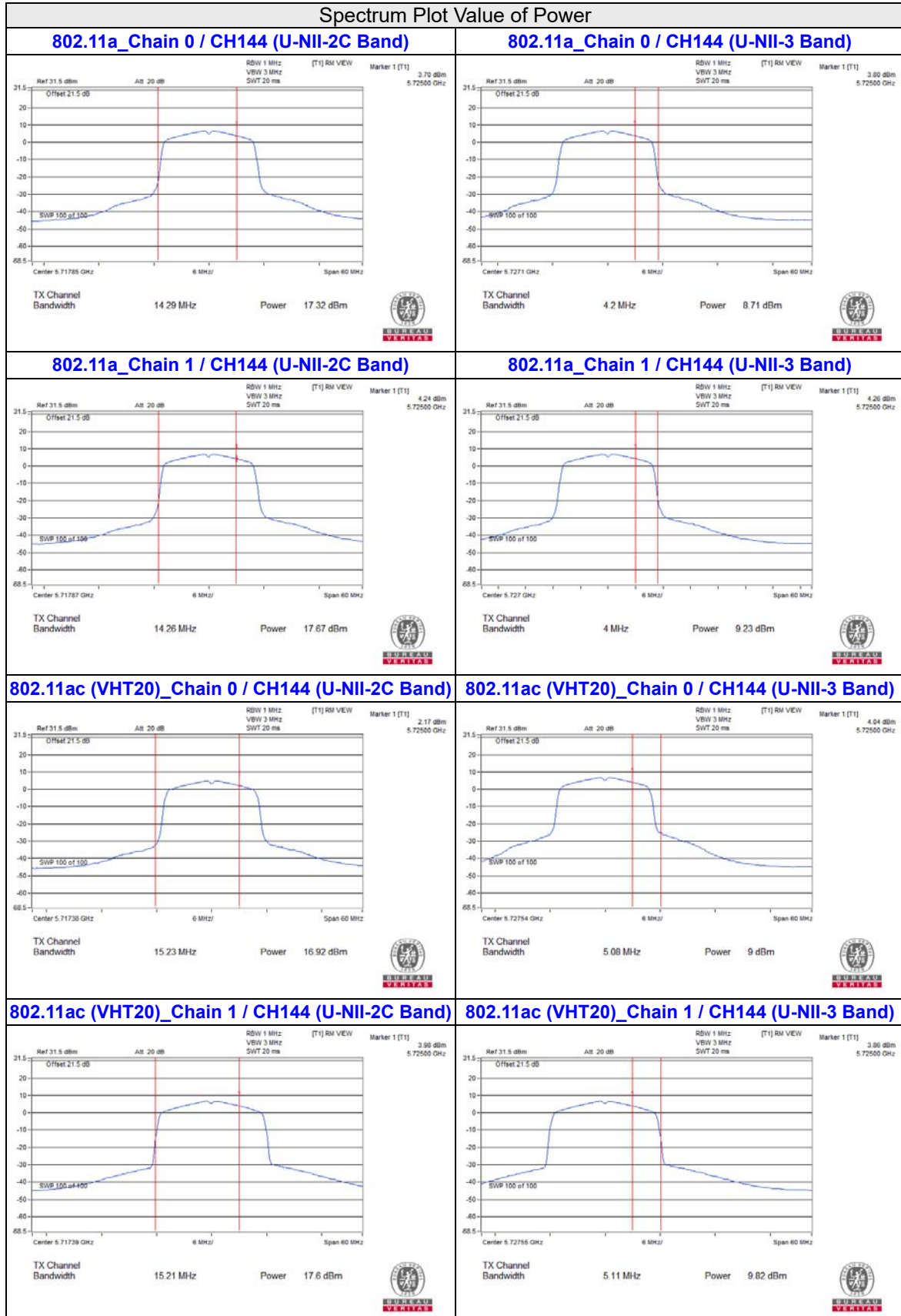

Spectrum Plot Value of Power

802.11ac (VHT40)_Chain 0 / CH142 (U-NII-2C Band) 802.11ac (VHT40)_Chain 0 / CH142 (U-NII-3 Band)

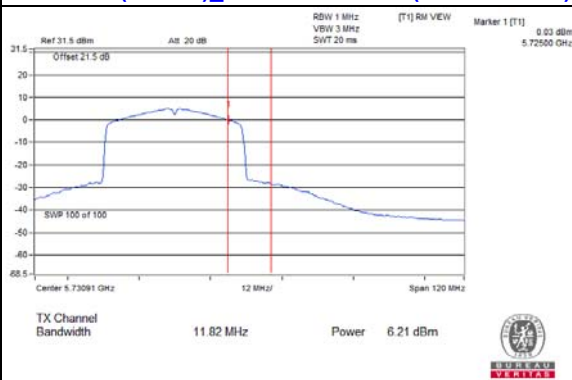
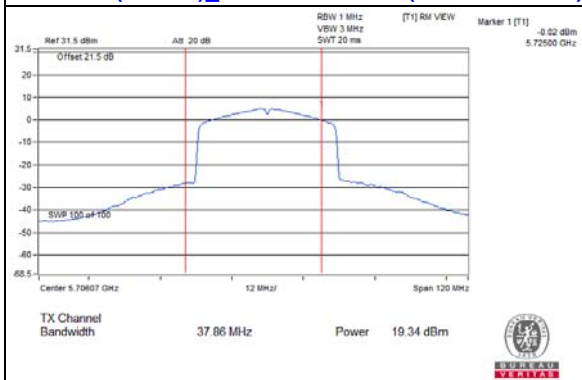

802.11ac (VHT40)_Chain 1 / CH142 (U-NII-2C Band) 802.11ac (VHT40)_Chain 1 / CH142 (U-NII-3 Band)

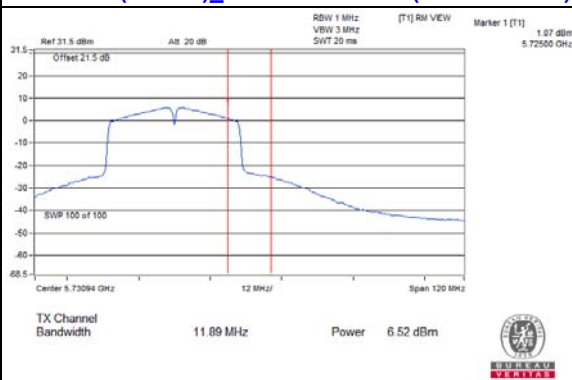
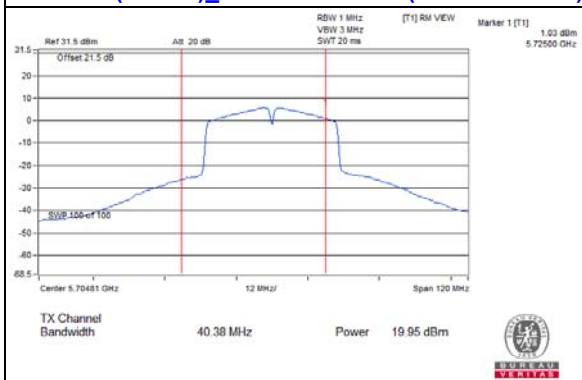

802.11ac (VHT80)_Chain 0 / CH138 (U-NII-2C Band) 802.11ac (VHT80)_Chain 0 / CH138 (U-NII-3 Band)

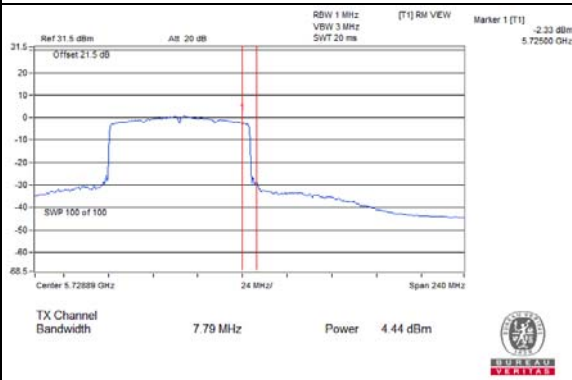
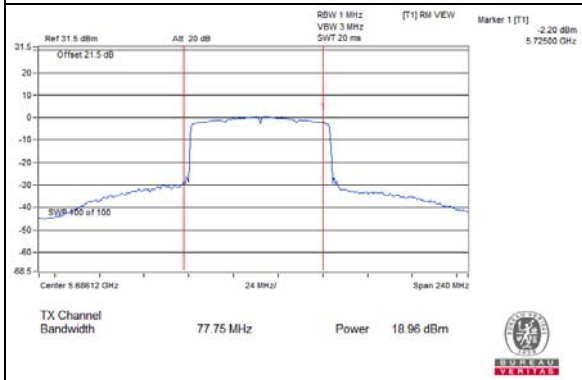

802.11ac (VHT80)_Chain 1 / CH138 (U-NII-2C Band) 802.11ac (VHT80)_Chain 1 / CH138 (U-NII-3 Band)

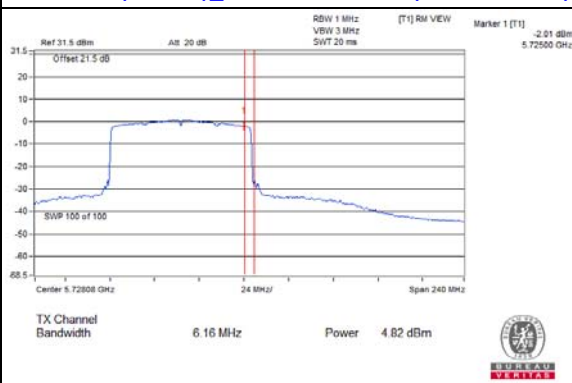
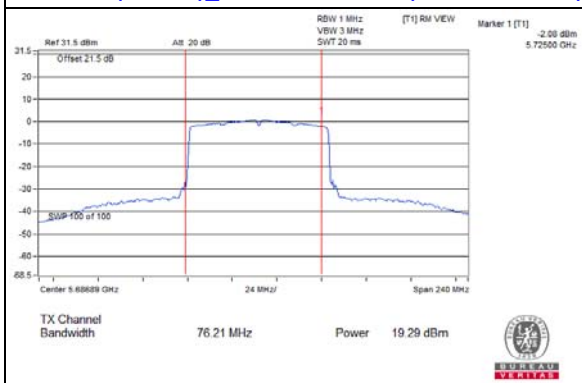

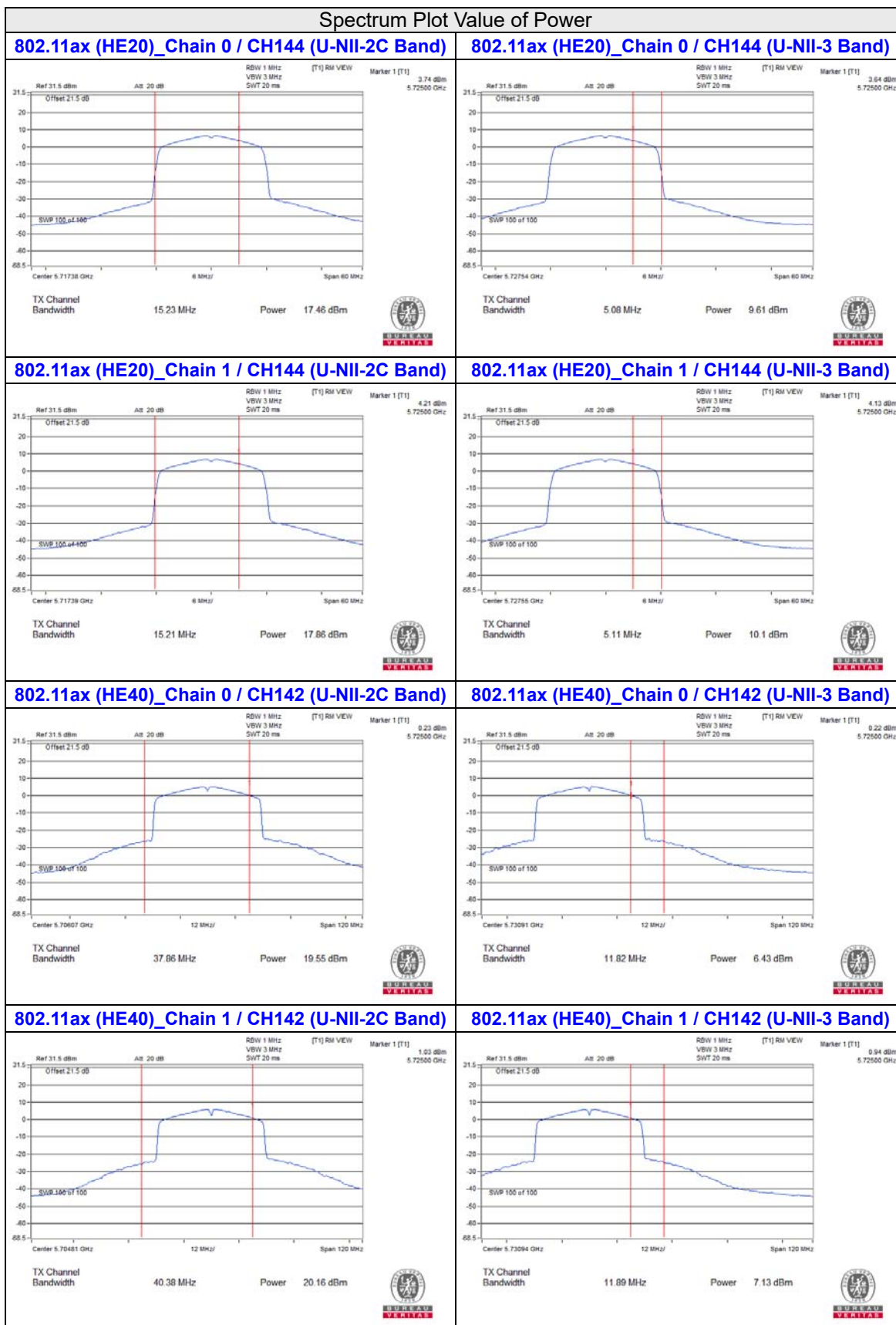

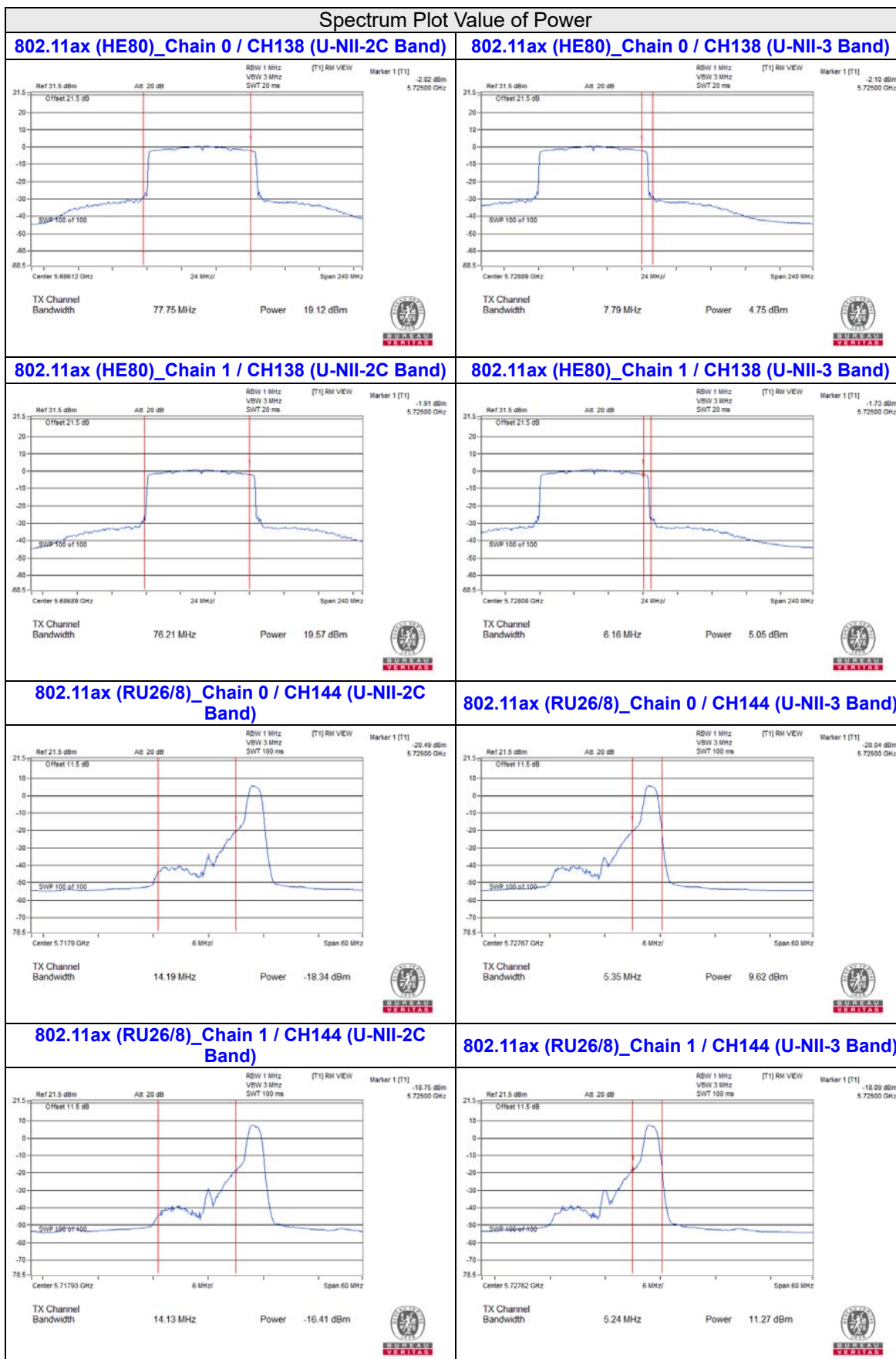

Spectrum Plot Value of Power

802.11ax (RU26/0)_Chain 0 / CH144 (U-NII-2C Band)

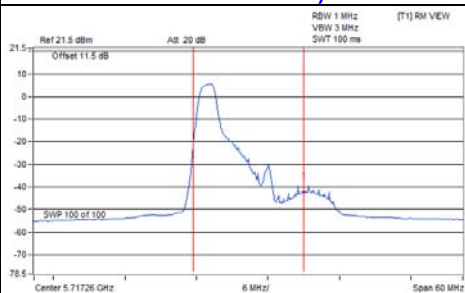

TX Channel Bandwidth 15.48 MHz Power 9.6 dBm



802.11ax (RU26/0)_Chain 0 / CH144 (U-NII-3 Band)

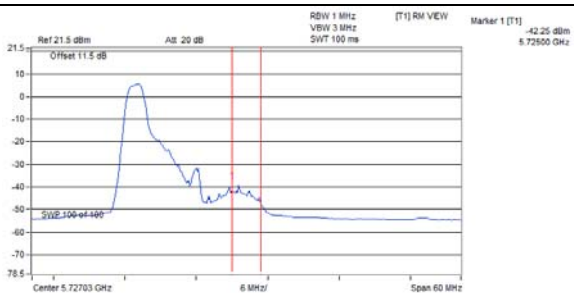

TX Channel Bandwidth 4.06 MHz Power -35.71 dBm



802.11ax (RU26/0)_Chain 1 / CH144 (U-NII-2C Band)

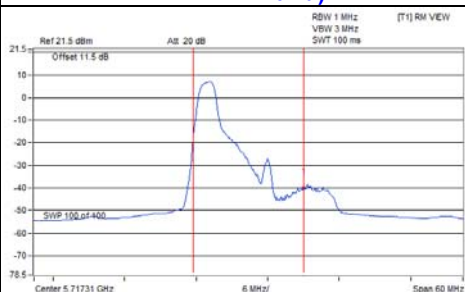

TX Channel Bandwidth 15.38 MHz Power 11.06 dBm



802.11ax (RU26/0)_Chain 1 / CH144 (U-NII-3 Band)

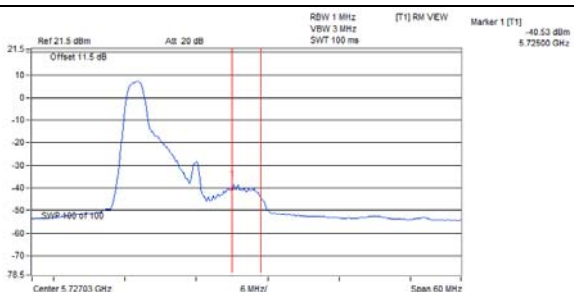

TX Channel Bandwidth 4.06 MHz Power -33.4 dBm



802.11ax (RU52/40)_Chain 0 / CH144 (U-NII-2C Band)

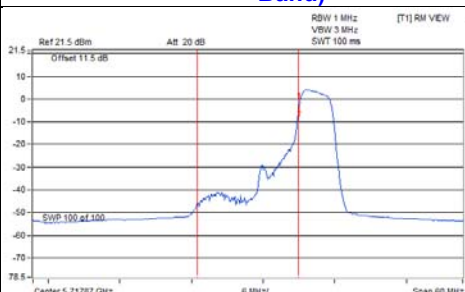

TX Channel Bandwidth 14.25 MHz Power -9.91 dBm



802.11ax (RU52/40)_Chain 0 / CH144 (U-NII-3 Band)

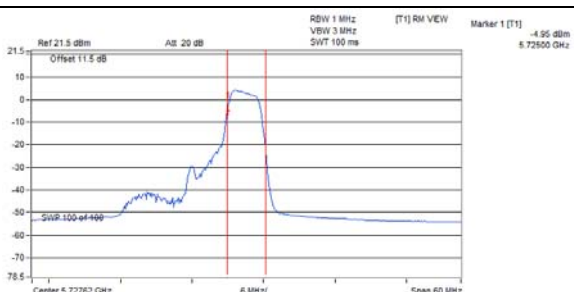

TX Channel Bandwidth 5.24 MHz Power 10.34 dBm



802.11ax (RU52/40)_Chain 1 / CH144 (U-NII-2C Band)

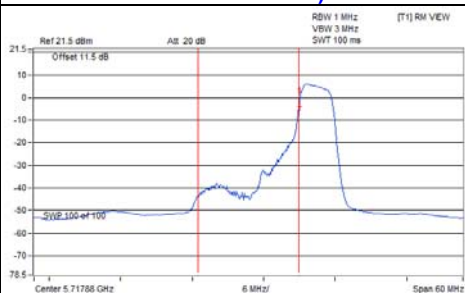

TX Channel Bandwidth 14.24 MHz Power -8.13 dBm



802.11ax (RU52/40)_Chain 1 / CH144 (U-NII-3 Band)

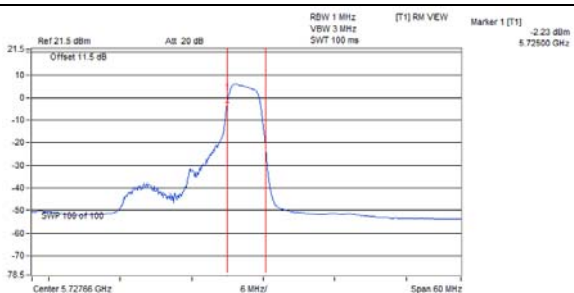

TX Channel Bandwidth 5.32 MHz Power 12.27 dBm



Spectrum Plot Value of Power

802.11ax (RU52/37)_Chain 0 / CH144 (U-NII-2C Band)

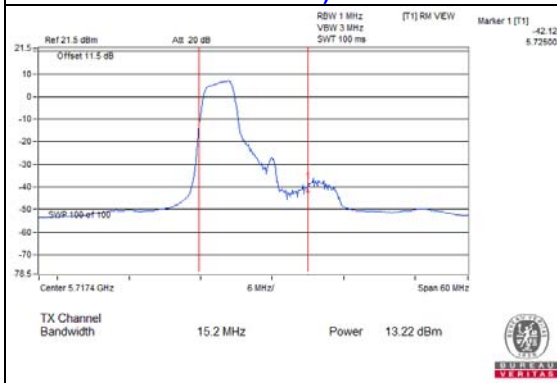

802.11ax (RU52/37)_Chain 0 / CH144 (U-NII-3 Band)

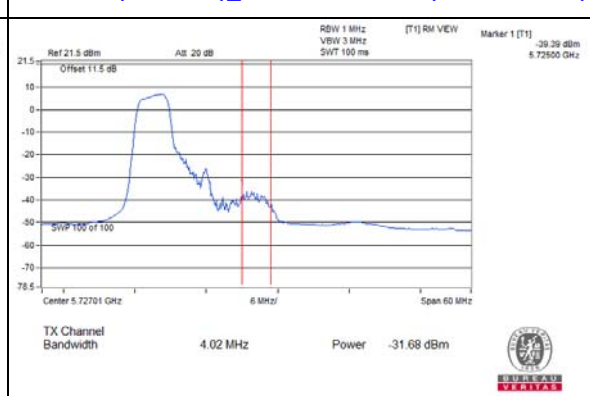

802.11ax (RU52/37)_Chain 1 / CH144 (U-NII-2C Band)

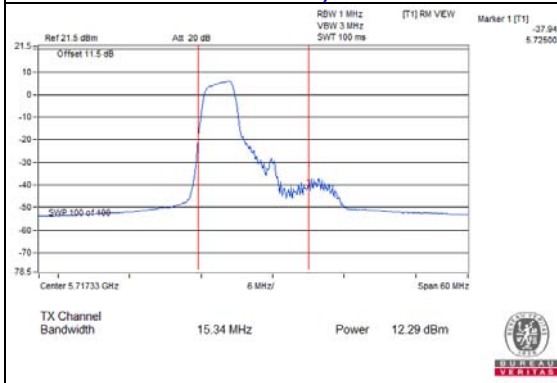

802.11ax (RU52/37)_Chain 1 / CH144 (U-NII-3 Band)

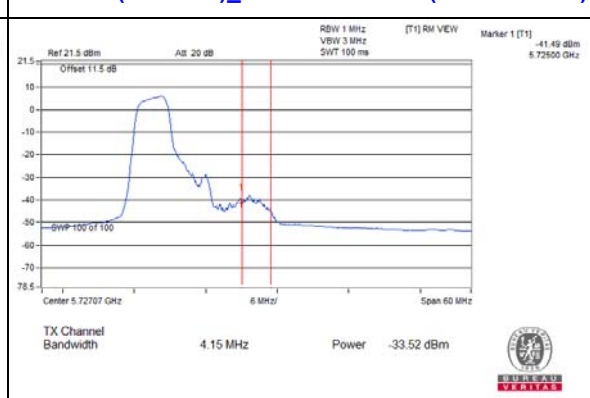

802.11ax (RU106/54)_Chain 0 / CH144 (U-NII-2C Band)

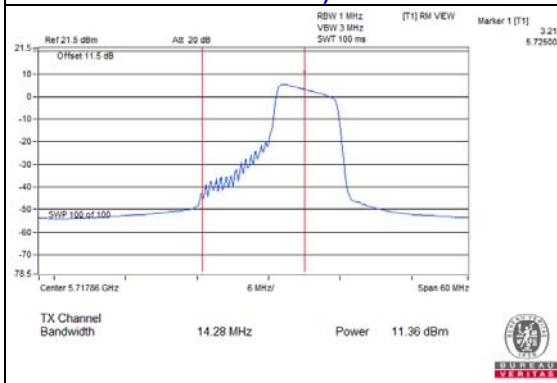

802.11ax (RU106/54)_Chain 0 / CH144 (U-NII-3 Band)

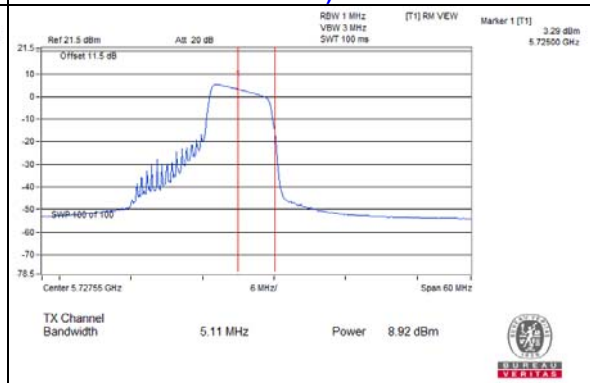

802.11ax (RU106/54)_Chain 1 / CH144 (U-NII-2C Band)

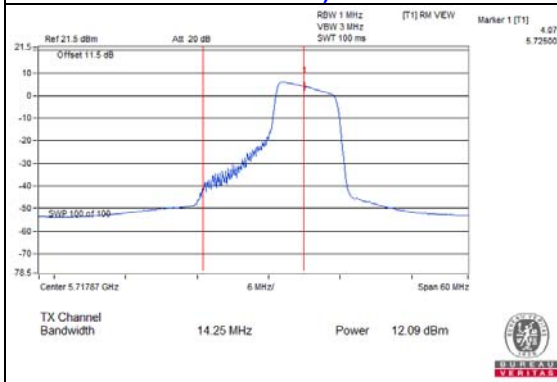

802.11ax (RU106/54)_Chain 1 / CH144 (U-NII-3 Band)

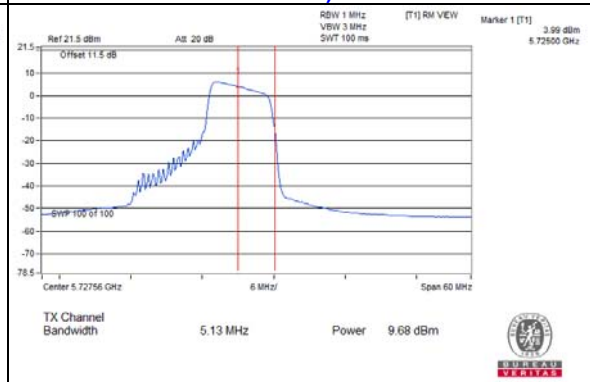

Spectrum Plot Value of Power

802.11ax (RU106/53)_Chain 0 / CH144 (U-NII-2C Band)

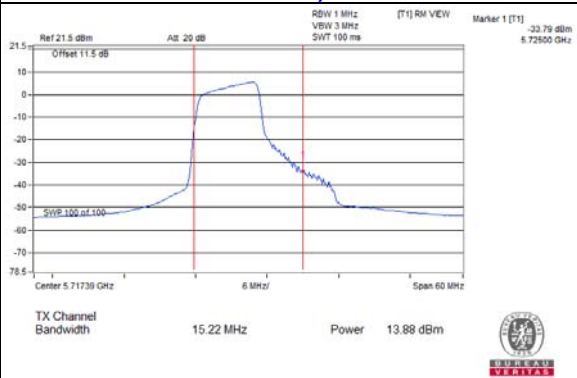

802.11ax (RU106/53)_Chain 0 / CH144 (U-NII-3 Band)

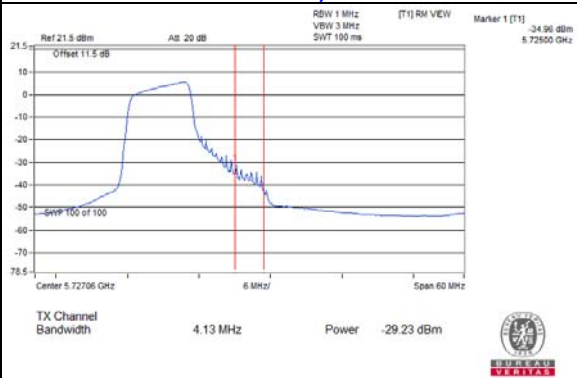

802.11ax (RU106/53)_Chain 1 / CH144 (U-NII-2C Band)

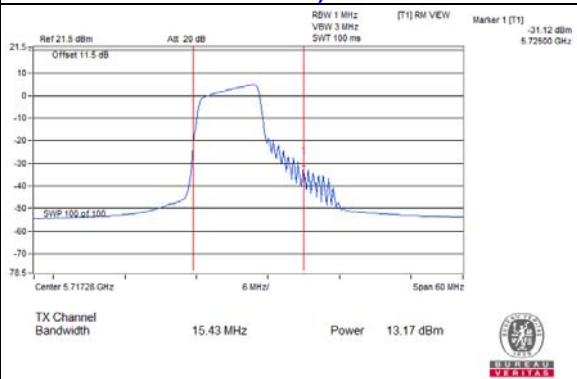

802.11ax (RU106/53)_Chain 1 / CH144 (U-NII-3 Band)

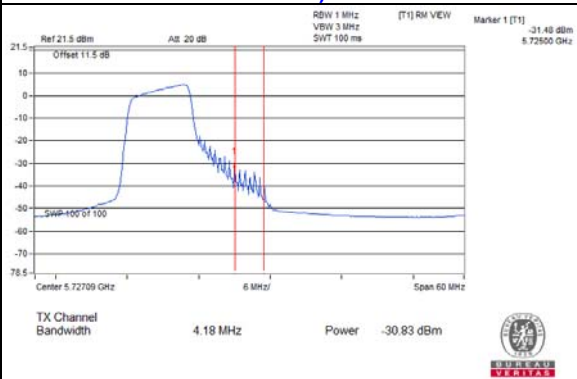

Beamforming Mode



Spectrum Plot Value of Power

802.11ac (VHT80)_Chain 0 / CH138 (U-NII-2C Band)

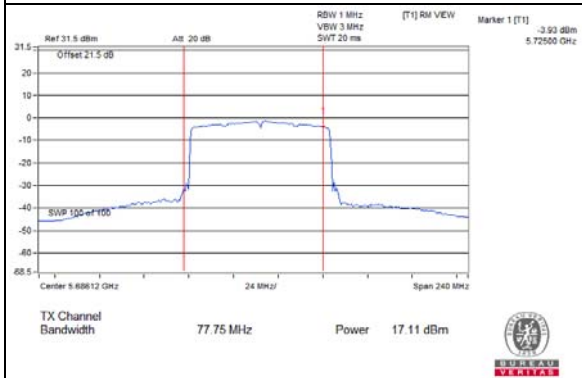

802.11ac (VHT80)_Chain 0 / CH138 (U-NII-3 Band)

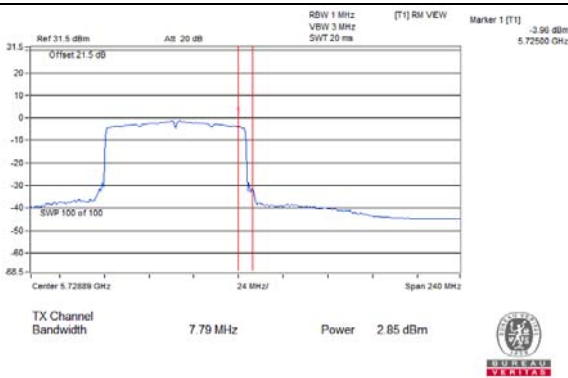

802.11ac (VHT80)_Chain 1 / CH138 (U-NII-2C Band)

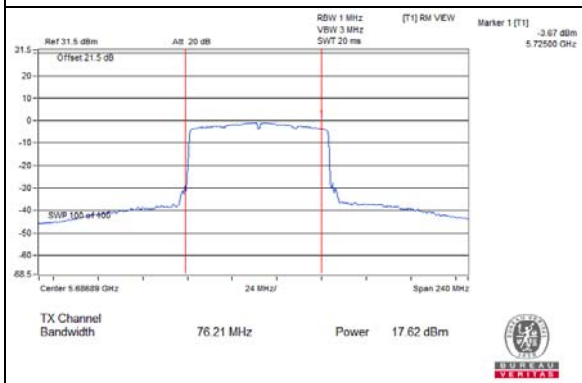

802.11ac (VHT80)_Chain 1 / CH138 (U-NII-3 Band)

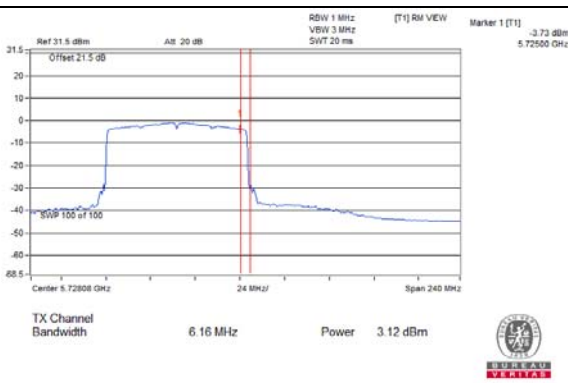

Spectrum Plot Value of Power

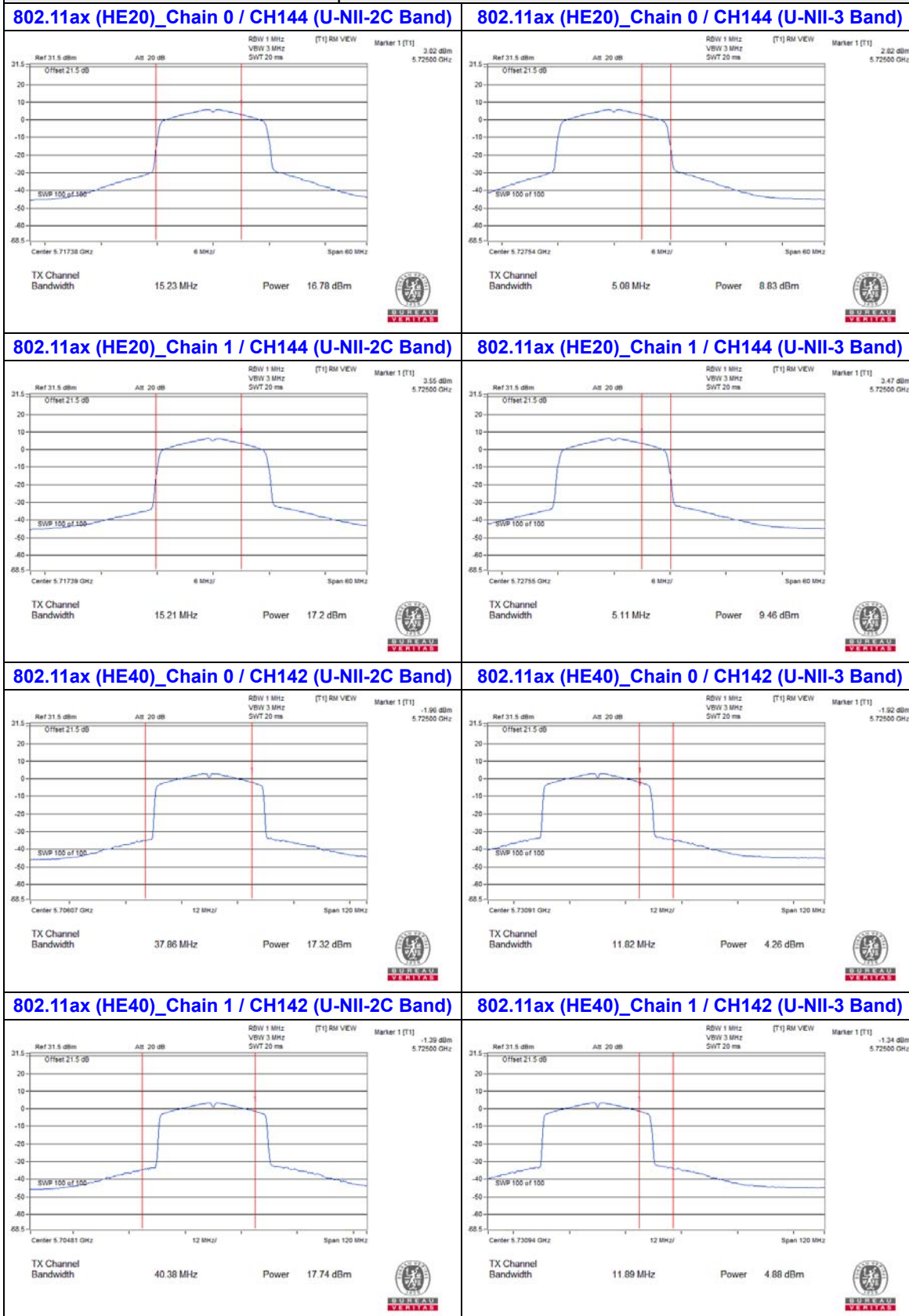

Spectrum Plot Value of Power

802.11ax (HE80)_Chain 0 / CH138 (U-NII-2C Band)

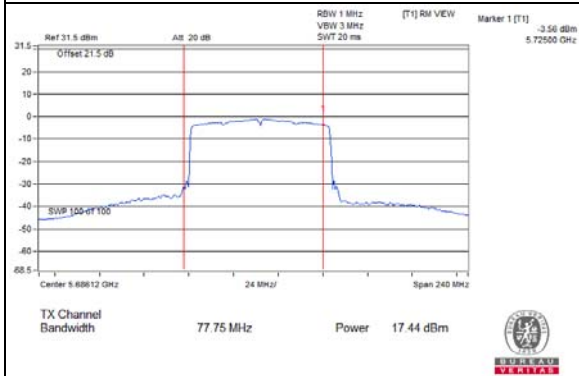

802.11ax (HE80)_Chain 0 / CH138 (U-NII-3 Band)

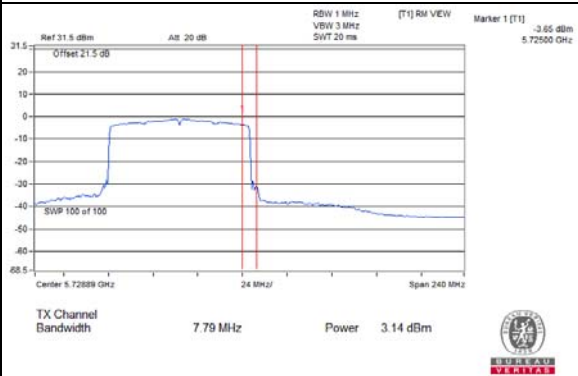

802.11ax (HE80)_Chain 1 / CH138 (U-NII-2C Band)

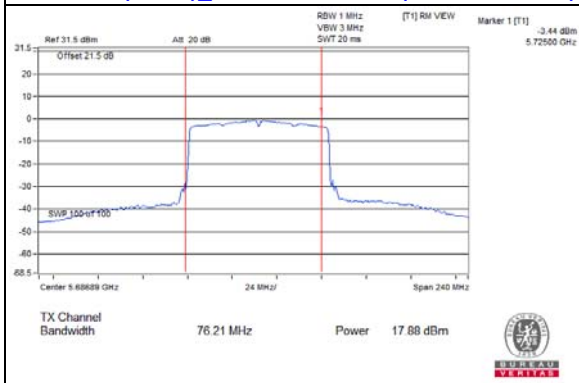

802.11ax (HE80)_Chain 1 / CH138 (U-NII-3 Band)

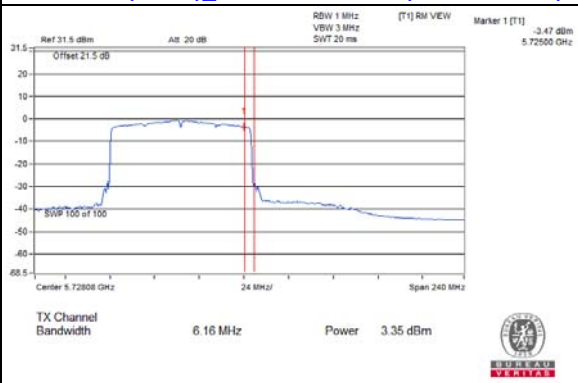

26dB OCCUPIED BANDWIDTH

CDD Mode

802.11a

Channel	Frequency (MHz)	26dB Bandwidth (MHz)	
		Chain0	Chain1
52	5260	18.47	18.17
60	5300	18.45	18.14
64	5320	18.42	18.1
100	5500	18.41	18.09
116	5580	18.44	18.15
140	5700	18.46	18.13
144 (U-NII-2C Band)	5720	14.29	14.26

802.11ax (HE20)

Channel	Frequency (MHz)	26dB Bandwidth (MHz)	
		Chain0	Chain1
52	5260	20.46	20.34
60	5300	20.46	20.33
64	5320	20.5	20.32
100	5500	20.45	20.31
116	5580	20.45	20.32
140	5700	20.44	20.31
144 (U-NII-2C Band)	5720	15.23	15.21

802.11ax (HE40)

Channel	Frequency (MHz)	26dB Bandwidth (MHz)	
		Chain0	Chain1
54	5270	61.91	51.5
62	5310	40.77	40.85
102	5510	40.71	40.84
110	5550	49.85	44.88
134	5670	40.76	40.9
142 (U-NII-2C Band)	5710	37.86	40.38

802.11ax (HE80)

Channel	Frequency (MHz)	26dB Bandwidth (MHz)	
		Chain0	Chain1
58	5290	82.17	82.58
106	5530	82.24	82.63
122	5610	82.33	82.5
138 (U-NII-2C Band)	5690	77.75	76.21

802.11ax (RU26)

RU Configuration	Channel	Frequency (MHz)	26dB Bandwidth (MHz)	
			Chain0	Chain1
26/0	52	5260	17.76	17.76
26/4	60	5300	14.76	14.88
26/8	64	5320	17.88	17.88
26/0	100	5500	17.76	17.76
26/4	116	5580	14.88	14.88
26/8	140	5700	18	17.88
26/8	144 (U-NII-2C Band)	5720	13.28	13.28
26/0	144 (U-NII-2C Band)	5720	15.48	15.38

802.11ax (RU52)

RU Configuration	Channel	Frequency (MHz)	26dB Bandwidth (MHz)	
			Chain0	Chain1
52/37	52	5260	19.45	19.3
52/39	60	5300	18.22	18.19
52/40	64	5320	19.5	19.61
52/37	100	5500	19.49	19.29
52/39	116	5580	18.17	18.19
52/40	140	5700	19.48	19.58
52/40	144 (U-NII-2C Band)	5720	14.25	14.24
52/37	144 (U-NII-2C Band)	5720	15.2	15.34

802.11ax (RU106)

RU Configuration	Channel	Frequency (MHz)	26dB Bandwidth (MHz)	
			Chain0	Chain1
106/53	52	5260	19.58	19.36
106/54	60	5300	19.38	19.42
106/54	64	5320	19.4	19.39
106/53	100	5500	19.6	19.38
106/53	116	5580	19.56	19.35
106/54	140	5700	19.38	19.4
106/54	144 (U-NII-2C Band)	5720	14.28	14.25
106/53	144 (U-NII-2C Band)	5720	15.22	15.43

Spectrum Plot of Worst Value

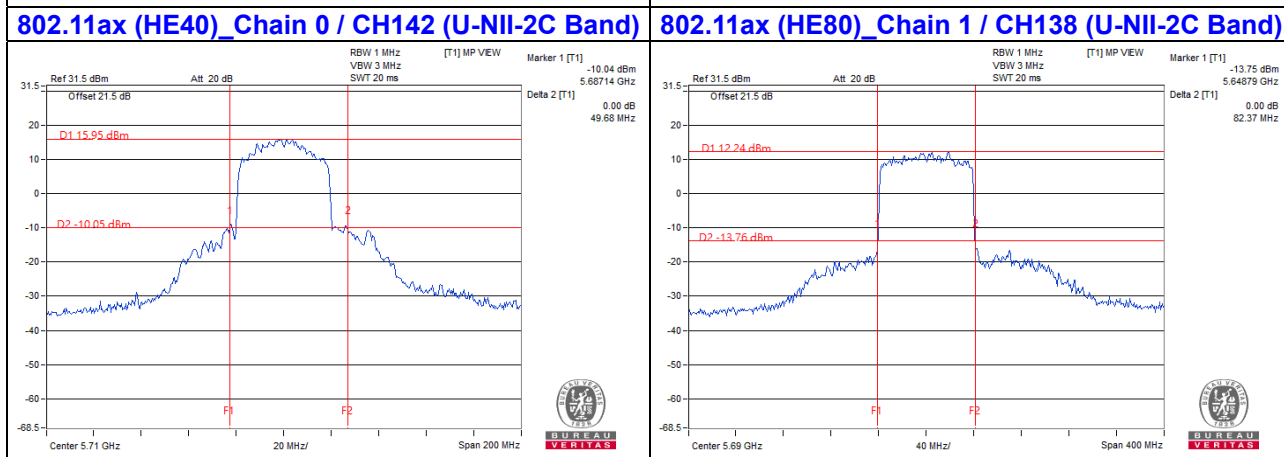
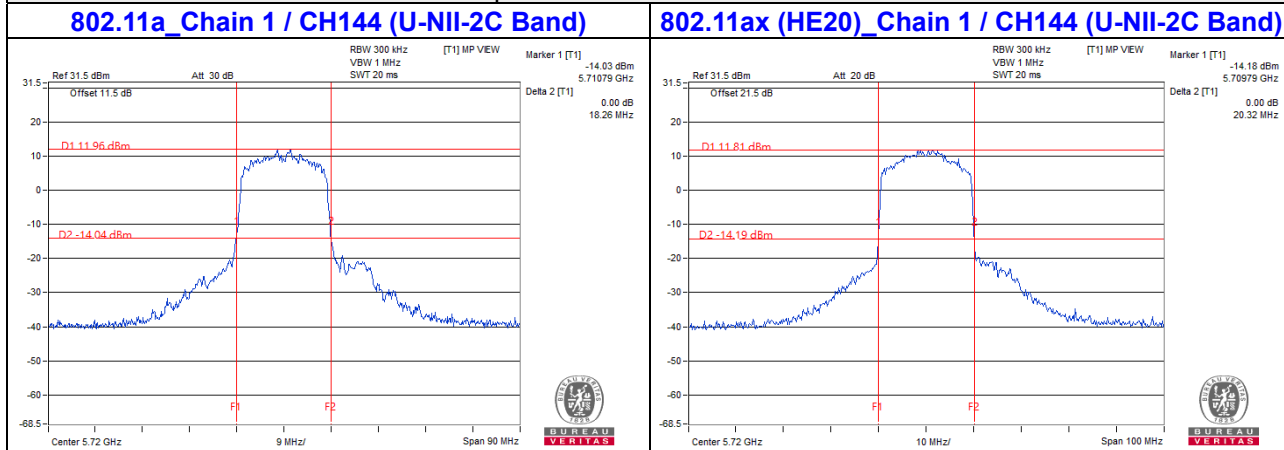

Note: For CH144 (U-NII-2C) = 5725MHz - Marker 1

Spectrum Plot of Worst Value

802.11ax (RU26/8)_Chain 0 / CH144 (U-NII-2C Band)

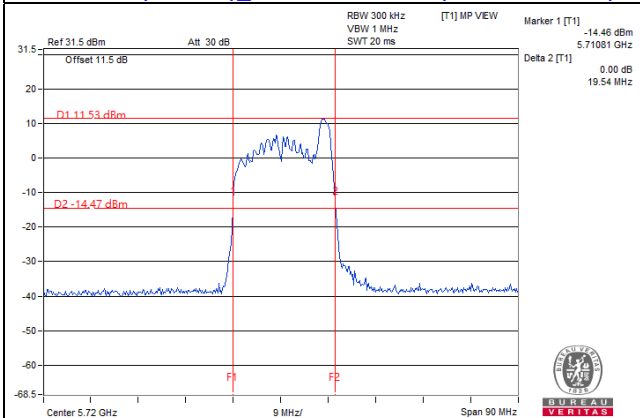

802.11ax (RU52/40)_Chain 1 / CH144 (U-NII-2C Band)

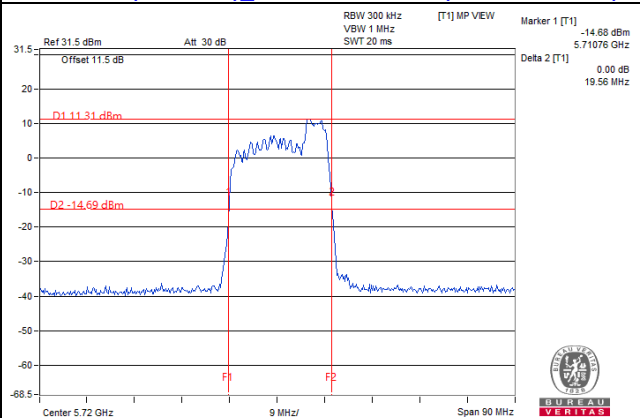

802.11ax (RU106/54)_Chain 1 / CH144 (U-NII-2C Band)

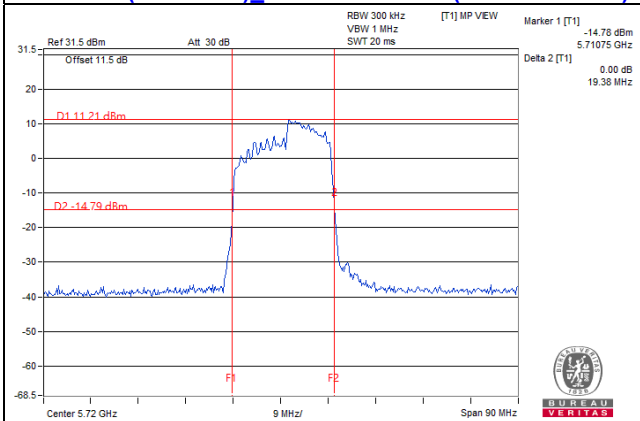

Note: For CH144 (U-NII-2C) = 5725MHz - Marker 1

For channel straddling 5725MHz of 26dB BW
CDD Mode

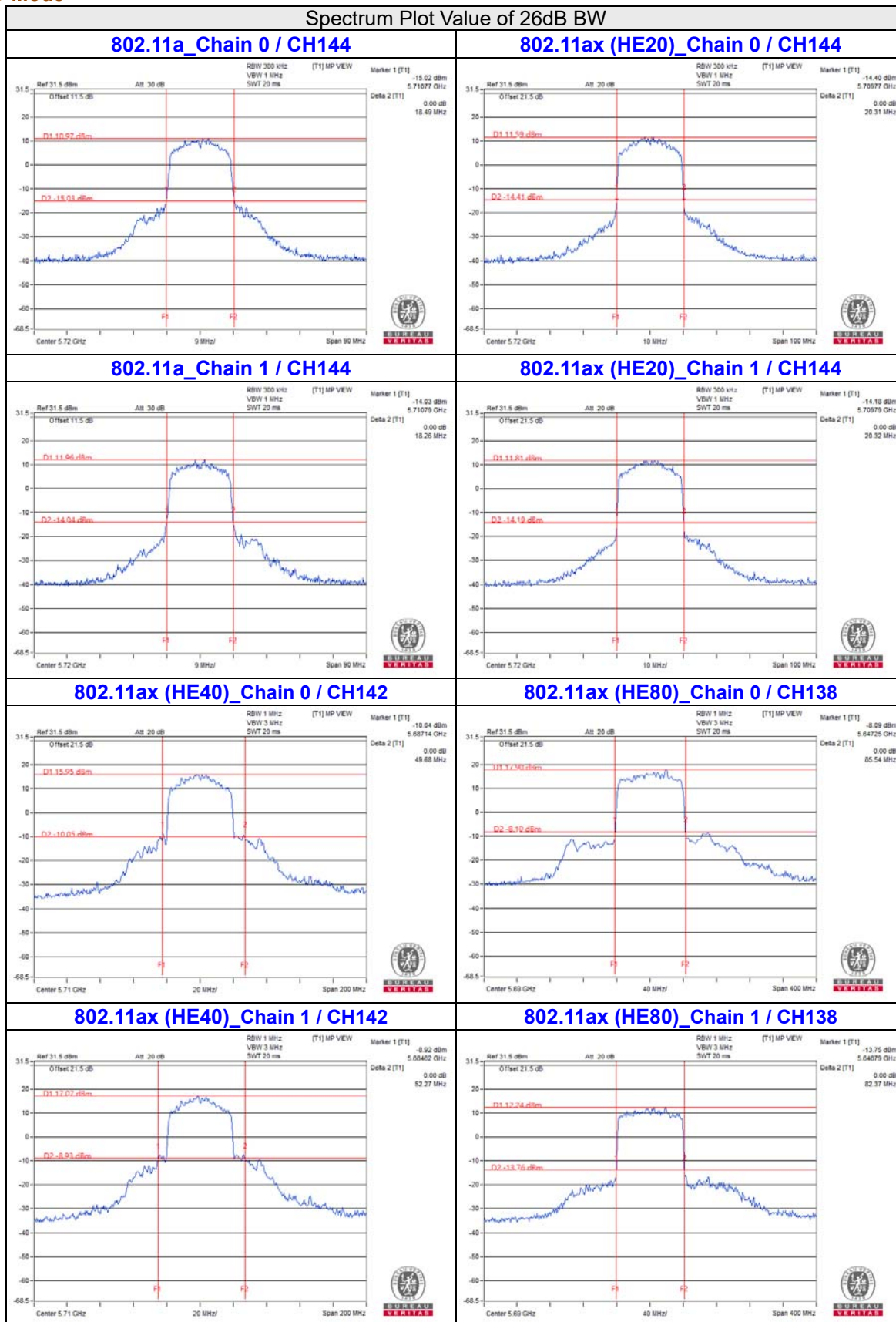

Spectrum Plot Value of 26dB BW

802.11ax (RU26/8)_Chain 0 / CH144

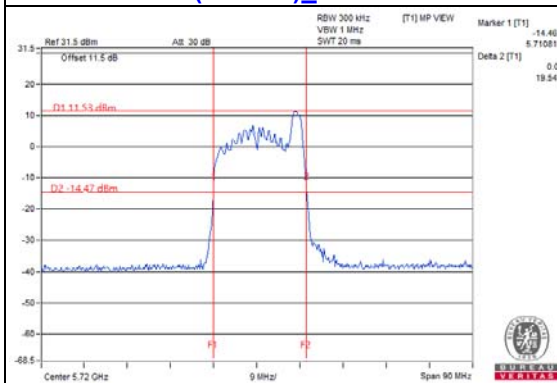

802.11ax (RU26/8)_Chain 1 / CH144

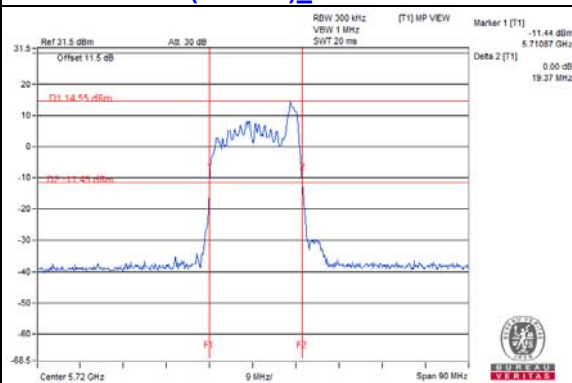

802.11ax (RU26/0)_Chain 0 / CH144

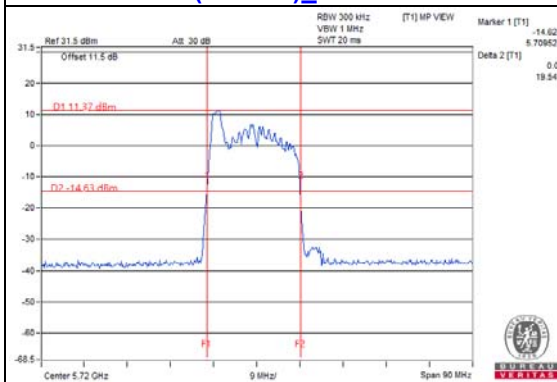

802.11ax (RU26/0)_Chain 1 / CH144

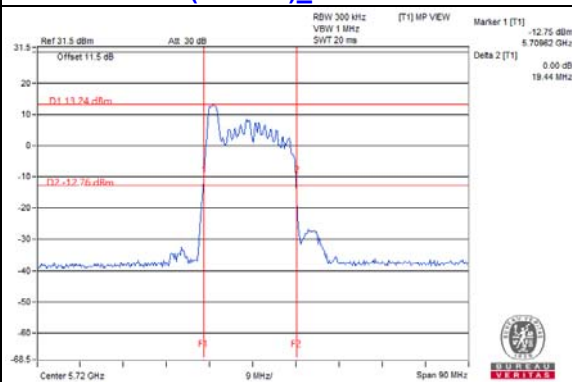

802.11ax (RU52/40)_Chain 0 / CH144

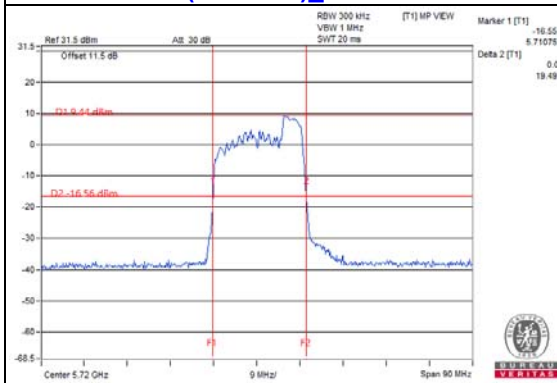

802.11ax (RU52/40)_Chain 1 / CH144

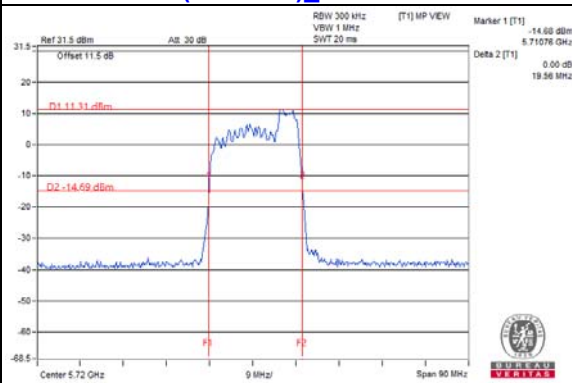

802.11ax (RU52/37)_Chain 0 / CH144

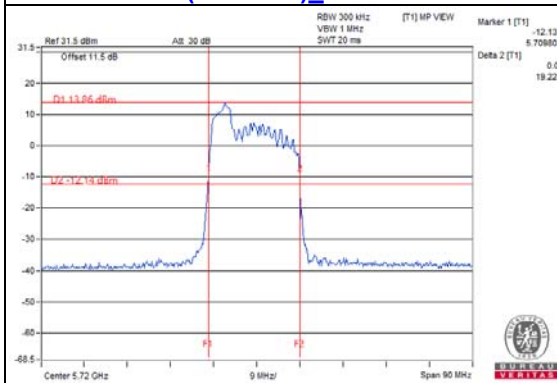

802.11ax (RU52/37)_Chain 1 / CH144

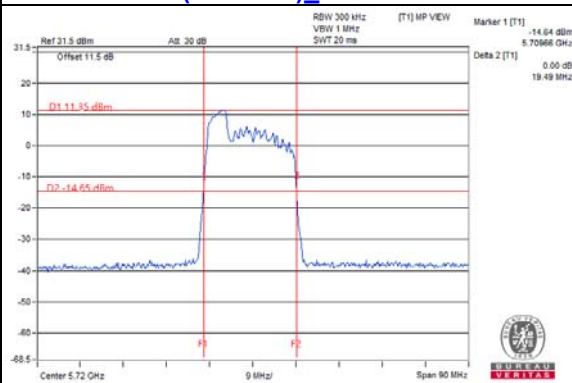

Spectrum Plot Value of 26dB BW

802.11ax (RU106/54)_Chain 0 / CH144

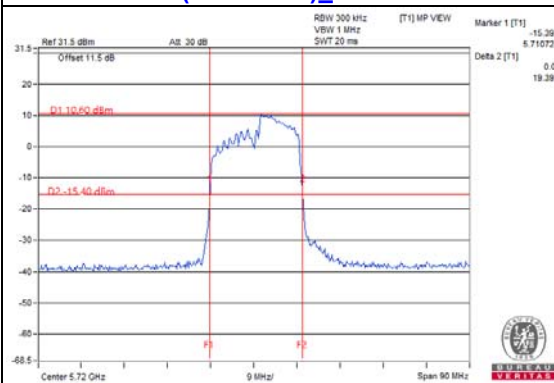

802.11ax (RU106/54)_Chain 1 / CH144

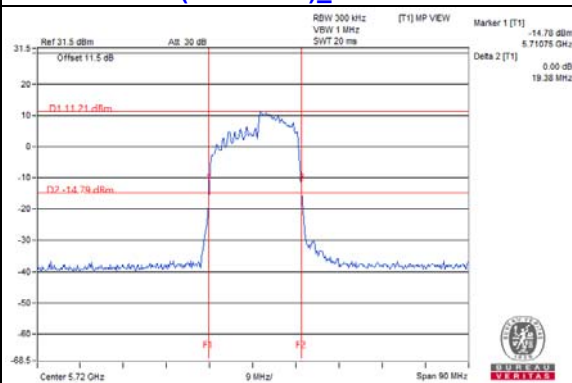

802.11ax (RU106/53)_Chain 0 / CH144

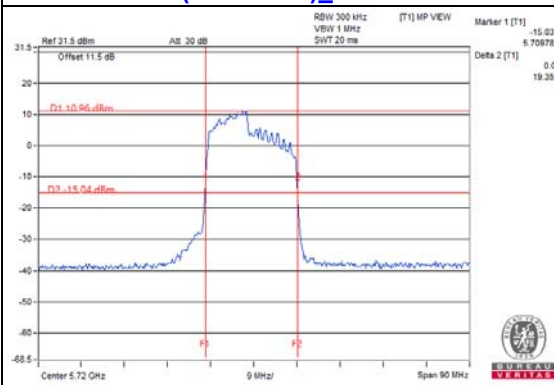

802.11ax (RU106/53)_Chain 1 / CH144

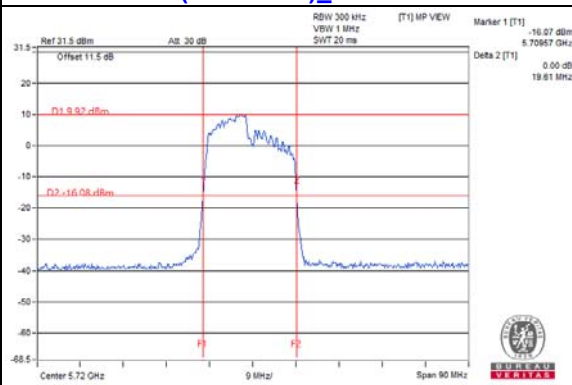

4.3.8 Test Results (Mode 2)

POWER OUTPUT
802.11a

Chan.	Chan. Freq. (MHz)	Average Power (mW)	Average Power (dBm)	Limit (dBm)	Pass / Fail
36	5180	153.462	21.86	24	Pass
40	5200	172.187	22.36	24	Pass
48	5240	171.002	22.33	24	Pass
52	5260	172.187	22.36	24	Pass
60	5300	168.267	22.26	24	Pass
64	5320	132.739	21.23	24	Pass
100	5500	108.893	20.37	24	Pass
116	5580	170.216	22.31	24	Pass
140	5700	83.368	19.21	23.66	Pass
*144 (U-NII-2C Band)	5720	149.624	21.75	23.68	Pass
*144 (U-NII-3 Band)	5720	24.099	13.82	30	Pass
149	5745	170.608	22.32	30	Pass
157	5785	176.604	22.47	30	Pass
165	5825	172.584	22.37	30	Pass

Note: * Test was performed in accordance with Measurement follow FCC KDB 789033 UNII test procedure Method SA-1 and use spectrum analyzer test.

Note: For U-NII-2A, U-NII-2C Band output power limitation is determined based on 26dBc bandwidth

Power Limit = 11dBm + 10logB < U-NII-2A, U-NII-2C >			
Channel Number	Freq.(MHz)	Min. B(MHz)	Determined Conducted Limit (dBm)
52	5260	36.17	26.58 > 24
60	5300	36	26.56 > 24
64	5320	35.82	26.54 > 24
100	5500	20.89	24.19 > 24
116	5580	35.99	26.56 > 24
140	5700	18.49	23.66 < 24
144 (U-NII-2C Band)	5720	18.54	23.68 < 24

802.11ac (VHT20)

Chan.	Chan. Freq. (MHz)	Average Power (mW)	Average Power (dBm)	Limit (dBm)	Pass / Fail
36	5180	134.896	21.30	24	Pass
40	5200	162.93	22.12	24	Pass
48	5240	163.682	22.14	24	Pass
52	5260	169.434	22.29	24	Pass
60	5300	166.341	22.21	24	Pass
64	5320	116.681	20.67	24	Pass
100	5500	99.541	19.98	24	Pass
116	5580	167.109	22.23	24	Pass
140	5700	75.162	18.76	24	Pass
*144 (U-NII-2C Band)	5720	137.721	21.39	23.71	Pass
*144 (U-NII-3 Band)	5720	22.856	13.59	30	Pass
149	5745	166.725	22.22	30	Pass
157	5785	167.494	22.24	30	Pass
165	5825	162.93	22.12	30	Pass

Note: * Test was performed in accordance with Measurement follow FCC KDB 789033 UNII test procedure Method SA-1 and use spectrum analyzer test.

Note: For U-NII-2A, U-NII-2C Band output power limitation is determined based on 26dBc bandwidth

Power Limit = 11dBm + 10logB < U-NII-2A, U-NII-2C >			
Channel Number	Freq.(MHz)	Min. B(MHz)	Determined Conducted Limit (dBm)
52	5260	28.22	25.5 > 24
60	5300	28.16	25.49 > 24
64	5320	20.47	24.11 > 24
100	5500	20.43	24.1 > 24
116	5580	27.88	25.45 > 24
140	5700	20.46	24.1 > 24
144 (U-NII-2C Band)	5720	28.22	23.71 < 24

802.11ac (VHT40)

Chan.	Chan. Freq. (MHz)	Average Power (mW)	Average Power (dBm)	Limit (dBm)	Pass / Fail
38	5190	58.479	17.67	24	Pass
46	5230	133.66	21.26	24	Pass
54	5270	132.739	21.23	24	Pass
62	5310	64.565	18.10	24	Pass
102	5510	52.119	17.17	24	Pass
110	5550	132.13	21.21	24	Pass
134	5670	107.152	20.30	24	Pass
*142 (U-NII-2C Band)	5710	123.31	20.91	24	Pass
*142 (U-NII-3 Band)	5710	6.081	7.84	30	Pass
151	5755	130.017	21.14	30	Pass
159	5795	131.826	21.20	30	Pass

Note: * Test was performed in accordance with Measurement follow FCC KDB 789033 UNII test procedure Method SA-1 and use spectrum analyzer test.

Note: For U-NII-2A, U-NII-2C Band output power limitation is determined based on 26dBc bandwidth

Power Limit = 11dBm + 10logB < U-NII-2A, U-NII-2C >			
Channel Number	Freq.(MHz)	Min. B(MHz)	Determined Conducted Limit (dBm)
54	5270	62.69	28.97 > 24
62	5310	40.74	27.1 > 24
102	5510	40.78	27.1 > 24
110	5550	63.6	29.03 > 24
134	5670	40.81	27.1 > 24
142 (U-NII-2C Band)	5710	40.65	27.09 > 24

802.11ac (VHT80)

Chan.	Chan. Freq. (MHz)	Average Power (mW)	Average Power (dBm)	Limit (dBm)	Pass / Fail
42	5210	53.703	17.30	24	Pass
58	5290	60.674	17.83	24	Pass
106	5530	46.666	16.69	24	Pass
122	5610	116.145	20.65	24	Pass
*138 (U-NII-2C Band)	5690	109.084	20.38	24	Pass
*138 (U-NII-3 Band)	5690	4.006	6.03	30	Pass
155	5775	117.761	20.71	30	Pass

Note: * Test was performed in accordance with Measurement follow FCC KDB 789033 UNII test procedure Method SA-1 and use spectrum analyzer test.

Note: For U-NII-2A, U-NII-2C Band output power limitation is determined based on 26dBc bandwidth

Power Limit = 11dBm + 10logB < U-NII-2A, U-NII-2C >			
Channel Number	Freq.(MHz)	Min. B(MHz)	Determined Conducted Limit (dBm)
58	5290	82.24	30.15 > 24
106	5530	82.19	30.14 > 24
122	5610	115.39	31.62 > 24
138 (U-NII-2C Band)	5690	77.68	29.9 > 24

802.11ax (HE20)

Chan.	Chan. Freq. (MHz)	Average Power (mW)	Average Power (dBm)	Limit (dBm)	Pass / Fail
36	5180	138.995	21.43	24	Pass
40	5200	167.109	22.23	24	Pass
48	5240	169.044	22.28	24	Pass
52	5260	173.38	22.39	24	Pass
60	5300	171.002	22.33	24	Pass
64	5320	121.06	20.83	24	Pass
100	5500	102.329	20.10	24	Pass
116	5580	171.791	22.35	24	Pass
140	5700	77.268	18.88	24	Pass
*144 (U-NII-2C Band)	5720	139.316	21.44	23.71	Pass
*144 (U-NII-3 Band)	5720	22.961	13.61	30	Pass
149	5745	170.216	22.31	30	Pass
157	5785	172.584	22.37	30	Pass
165	5825	167.109	22.23	30	Pass

Note: * Test was performed in accordance with Measurement follow FCC KDB 789033 UNII test procedure Method SA-1 and use spectrum analyzer test.

Note: For U-NII-2A, U-NII-2C Band output power limitation is determined based on 26dBc bandwidth

Power Limit = 11dBm + 10logB < U-NII-2A, U-NII-2C >			
Channel Number	Freq.(MHz)	Min. B(MHz)	Determined Conducted Limit (dBm)
52	5260	28.22	25.5 > 24
60	5300	28.16	25.49 > 24
64	5320	20.47	24.11 > 24
100	5500	20.43	24.1 > 24
116	5580	27.88	25.45 > 24
140	5700	20.46	24.1 > 24
144 (U-NII-2C Band)	5720	18.67	23.71 < 24

802.11ax (HE40)

Chan.	Chan. Freq. (MHz)	Average Power (mW)	Average Power (dBm)	Limit (dBm)	Pass / Fail
38	5190	60.674	17.83	24	Pass
46	5230	137.088	21.37	24	Pass
54	5270	136.144	21.34	24	Pass
62	5310	66.527	18.23	24	Pass
102	5510	53.58	17.29	24	Pass
110	5550	137.088	21.37	24	Pass
134	5670	110.154	20.42	24	Pass
*142 (U-NII-2C Band)	5710	132.434	21.22	24	Pass
*142 (U-NII-3 Band)	5710	6.486	8.12	30	Pass
151	5755	134.586	21.29	30	Pass
159	5795	136.773	21.36	30	Pass

Note: * Test was performed in accordance with Measurement follow FCC KDB 789033 UNII test procedure Method SA-1 and use spectrum analyzer test.

Note: For U-NII-2A, U-NII-2C Band output power limitation is determined based on 26dBc bandwidth

Power Limit = 11dBm + 10logB < U-NII-2A, U-NII-2C >			
Channel Number	Freq.(MHz)	Min. B(MHz)	Determined Conducted Limit (dBm)
54	5270	62.69	28.97 > 24
62	5310	40.74	27.1 > 24
102	5510	40.78	27.1 > 24
110	5550	63.6	29.03 > 24
134	5670	40.81	27.1 > 24
142 (U-NII-2C Band)	5710	40.65	27.09 > 24

802.11ax (HE80)

Chan.	Chan. Freq. (MHz)	Average Power (mW)	Average Power (dBm)	Limit (dBm)	Pass / Fail
42	5210	55.335	17.43	24	Pass
58	5290	62.806	17.98	24	Pass
106	5530	48.084	16.82	24	Pass
122	5610	120.504	20.81	24	Pass
*138 (U-NII-2C Band)	5690	113.501	20.55	24	Pass
*138 (U-NII-3 Band)	5690	4.285	6.32	30	Pass
155	5775	121.06	20.83	30	Pass

Note: * Test was performed in accordance with Measurement follow FCC KDB 789033 UNII test procedure Method SA-1 and use spectrum analyzer test.

Note: For U-NII-2A, U-NII-2C Band output power limitation is determined based on 26dBc bandwidth

Power Limit = 11dBm + 10logB < U-NII-2A, U-NII-2C >			
Channel Number	Freq.(MHz)	Min. B(MHz)	Determined Conducted Limit (dBm)
58	5290	82.24	30.15 > 24
106	5530	82.19	30.14 > 24
122	5610	115.39	31.62 > 24
138 (U-NII-2C Band)	5690	77.68	29.9 > 24

802.11ax (RU26)

RU Configuration	Chan.	Chan. Freq. (MHz)	Average Power (mW)	Average Power (dBm)	Limit (dBm)	Pass / Fail
26/0	36	5180	27.227	14.35	24	Pass
26/4	40	5200	26.792	14.28	24	Pass
26/8	48	5240	27.102	14.33	24	Pass
26/0	52	5260	26.977	14.31	23.92	Pass
26/4	60	5300	26.915	14.30	23.51	Pass
26/8	64	5320	27.542	14.40	23.9	Pass
26/0	100	5500	27.416	14.38	23.92	Pass
26/4	116	5580	27.164	14.34	23.5	Pass
26/8	140	5700	26.915	14.30	23.91	Pass
26/8	*144 (U-NII-2C Band)	5720	0.04764	-13.22	22.51	Pass
26/8	*144 (U-NII-3 Band)	5720	26.002	14.15	30	Pass
26/0	*144 (U-NII-2C Band)	5720	24.717	13.93	22.9	Pass
26/0	*144 (U-NII-3 Band)	5720	0.0007015	-31.54	30	Pass
26/0	149	5745	170.216	22.31	30	Pass
26/4	157	5785	170.608	22.32	30	Pass
26/8	165	5825	171.791	22.35	30	Pass

Note: * Test was performed in accordance with Measurement follow FCC KDB 789033 UNII test procedure Method SA-1 and use spectrum analyzer test.

Note: For U-NII-2A, U-NII-2C Band output power limitation is determined based on 26dBc bandwidth

Power Limit = 11dBm + 10logB < U-NII-2A, U-NII-2C >			
Channel Number	Freq.(MHz)	Min. B(MHz)	Determined Conducted Limit (dBm)
52	5260	19.62	23.92 < 24
60	5300	17.84	23.51 < 24
64	5320	19.53	23.9 < 24
100	5500	19.61	23.92 < 24
116	5580	17.81	23.5 < 24
140	5700	19.58	23.91 < 24
144 (U-NII-2C Band)	5720	14.18	22.51 < 24
144 (U-NII-2C Band)	5720	15.5	22.9 < 24

802.11ax (RU52)

RU Configuration	Chan.	Chan. Freq. (MHz)	Average Power (mW)	Average Power (dBm)	Limit (dBm)	Pass / Fail
52/37	36	5180	45.604	16.59	24	Pass
52/39	40	5200	45.814	16.61	24	Pass
52/40	48	5240	45.499	16.58	24	Pass
52/37	52	5260	48.306	16.84	23.9	Pass
52/39	60	5300	50.234	17.01	23.6	Pass
52/40	64	5320	48.865	16.89	23.9	Pass
52/37	100	5500	46.132	16.64	23.9	Pass
52/39	116	5580	47.206	16.74	23.6	Pass
52/40	140	5700	49.091	16.91	23.9	Pass
52/40	*144 (U-NII-2C Band)	5720	0.4732	-3.25	22.53	Pass
52/40	*144 (U-NII-3 Band)	5720	49.545	16.95	30	Pass
52/37	*144 (U-NII-2C Band)	5720	49.545	16.95	22.85	Pass
52/37	*144 (U-NII-3 Band)	5720	0.001245	-29.05	30	Pass
52/37	149	5745	171.791	22.35	30	Pass
52/39	157	5785	172.982	22.38	30	Pass
52/40	165	5825	174.181	22.41	30	Pass

Note: * Test was performed in accordance with Measurement follow FCC KDB 789033 UNII test procedure Method SA-1 and use spectrum analyzer test.

Note: For U-NII-2A, U-NII-2C Band output power limitation is determined based on 26dBc bandwidth

Power Limit = 11dBm + 10logB < U-NII-2A, U-NII-2C >			
Channel Number	Freq.(MHz)	Min. B(MHz)	Determined Conducted Limit (dBm)
52	5260	19.51	23.9 < 24
60	5300	18.21	23.6 < 24
64	5320	19.51	23.9 < 24
100	5500	19.51	23.9 < 24
116	5580	18.23	23.6 < 24
140	5700	19.51	23.9 < 24
144 (U-NII-2C Band)	5720	14.24	22.53 < 24
144 (U-NII-2C Band)	5720	15.32	22.85 < 24

802.11ax (RU106)

RU Configuration	Chan.	Chan. Freq. (MHz)	Average Power (mW)	Average Power (dBm)	Limit (dBm)	Pass / Fail
106/53	36	5180	73.79	18.68	24	Pass
106/53	40	5200	72.111	18.58	24	Pass
106/54	48	5240	74.989	18.75	24	Pass
106/53	52	5260	74.302	18.71	23.91	Pass
106/54	60	5300	78.343	18.94	23.87	Pass
106/54	64	5320	77.09	18.87	23.87	Pass
106/53	100	5500	71.779	18.56	23.93	Pass
106/53	116	5580	73.282	18.65	23.92	Pass
106/54	140	5700	79.616	19.01	24	Pass
106/54	*144 (U-NII-2C Band)	5720	46.026	16.63	22.54	Pass
106/54	*144 (U-NII-3 Band)	5720	26.002	14.15	30	Pass
106/53	*144 (U-NII-2C Band)	5720	75.683	18.79	22.86	Pass
106/53	*144 (U-NII-3 Band)	5720	0.003846	-24.15	30	Pass
106/53	149	5745	173.38	22.39	30	Pass
106/54	157	5785	174.582	22.42	30	Pass
106/54	165	5825	176.198	22.46	30	Pass

Note: * Test was performed in accordance with Measurement follow FCC KDB 789033 UNII test procedure Method SA-1 and use spectrum analyzer test.

Note: For U-NII-2A, U-NII-2C Band output power limitation is determined based on 26dBc bandwidth

Power Limit = 11dBm + 10logB < U-NII-2A, U-NII-2C >			
Channel Number	Freq.(MHz)	Min. B(MHz)	Determined Conducted Limit (dBm)
52	5260	19.55	23.91 < 24
60	5300	19.4	23.87 < 24
64	5320	19.39	23.87 < 24
100	5500	19.64	23.93 < 24
116	5580	19.63	23.92 < 24
140	5700	20.52	24.12 > 24
144 (U-NII-2C Band)	5720	14.28	22.54 < 24
144 (U-NII-2C Band)	5720	15.37	22.86 < 24

For channel straddling 5725MHz of Power

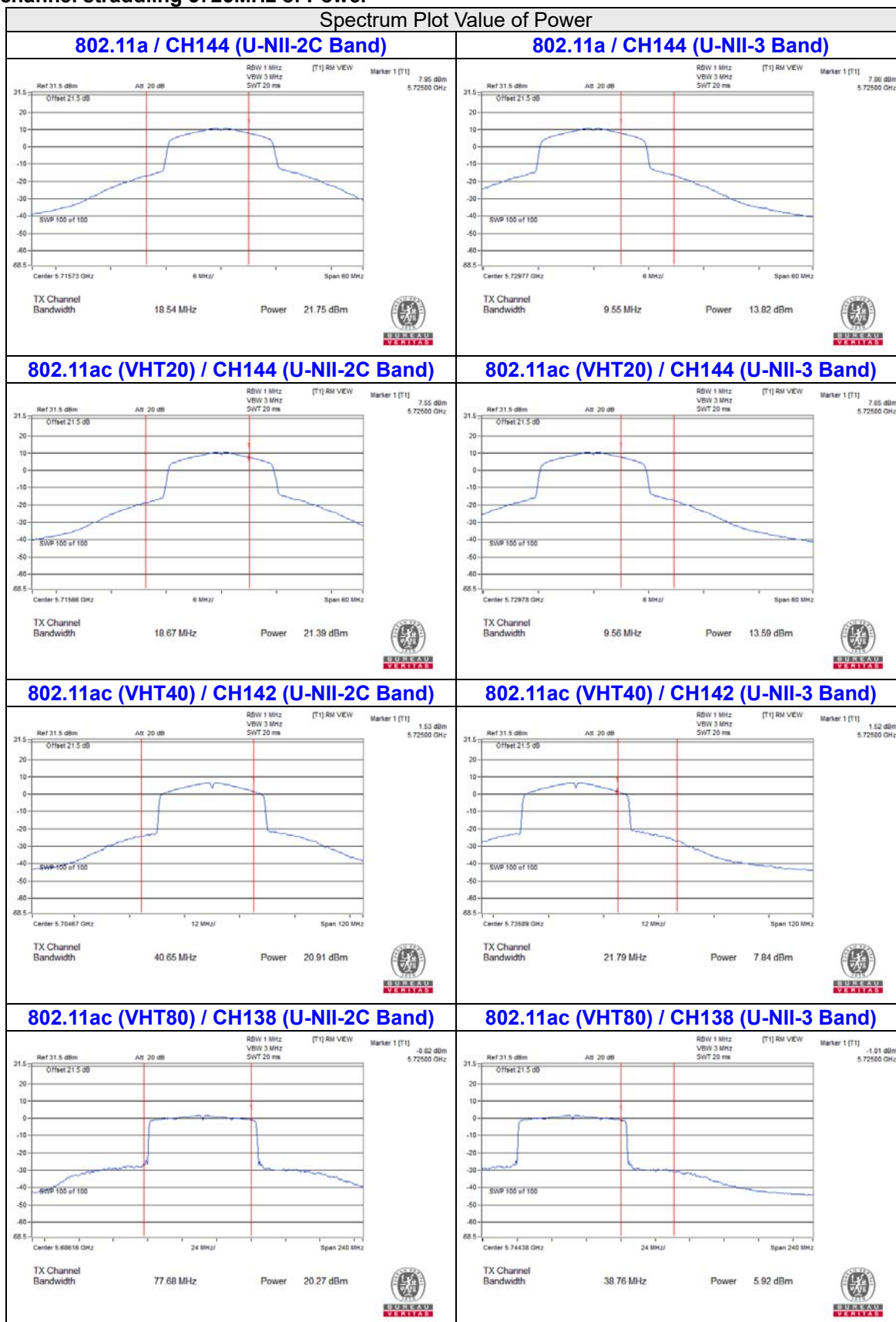

Spectrum Plot Value of Power

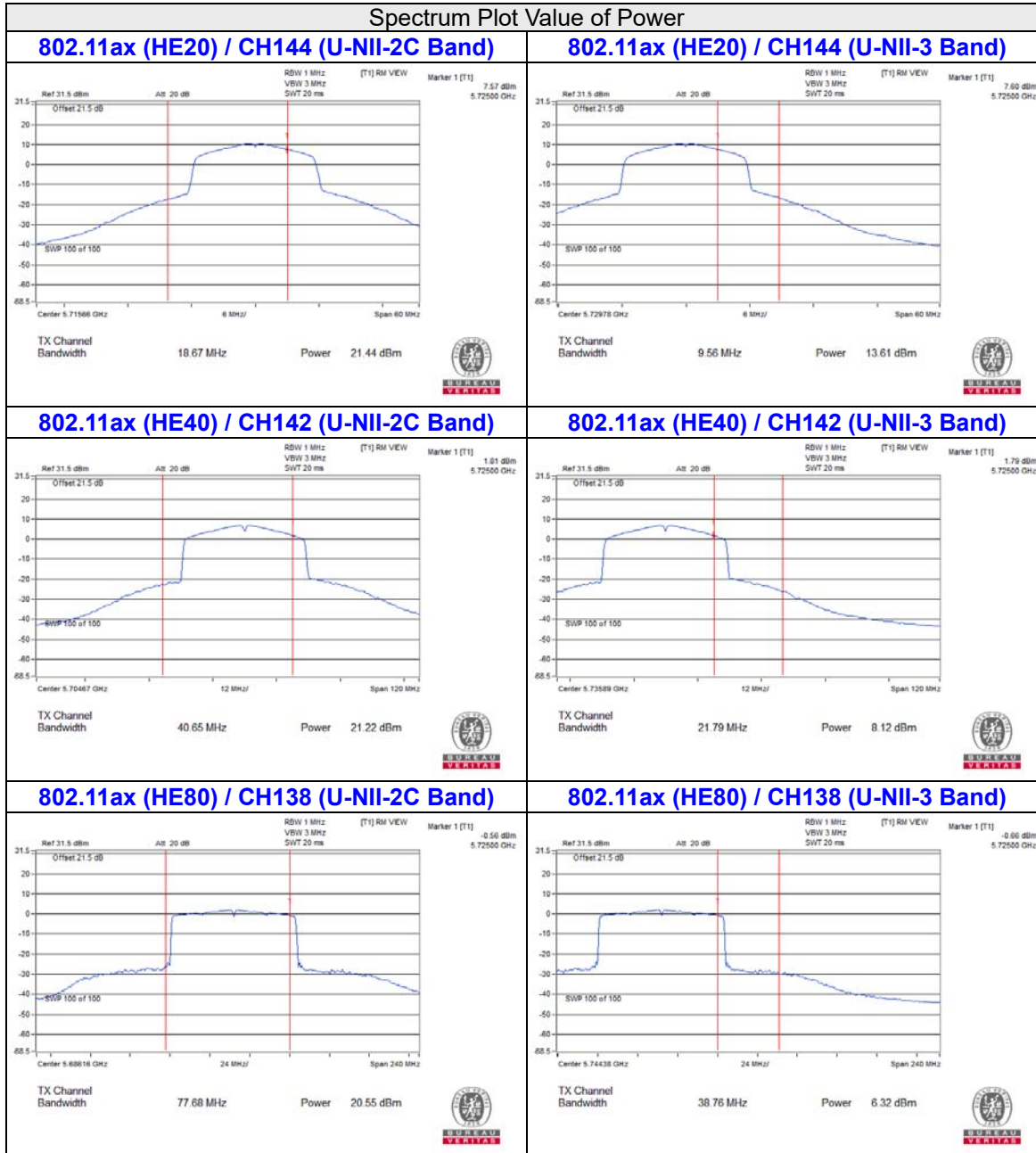

Spectrum Plot Value of Power

802.11ax (RU26/8) / CH144 (U-NII-2C Band)

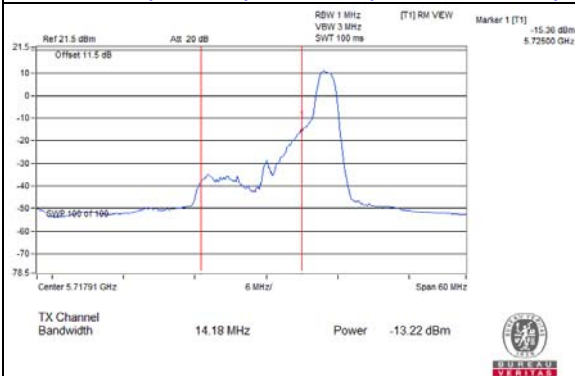

802.11ax (RU26/8) / CH144 (U-NII-3 Band)

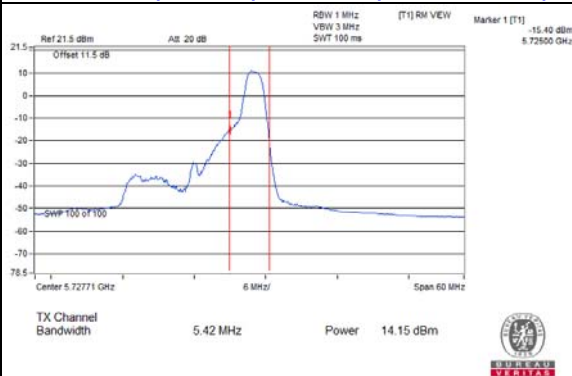

802.11ax (RU26/0) / CH144 (U-NII-2C Band)

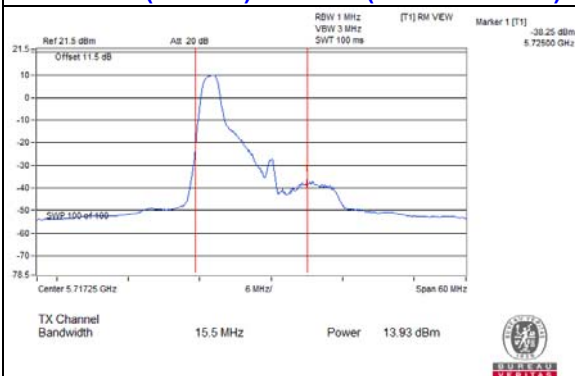

802.11ax (RU26/0) / CH144 (U-NII-3 Band)

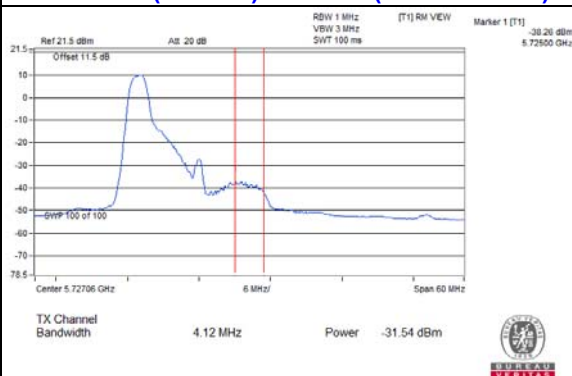

802.11ax (RU52/40) / CH144 (U-NII-2C Band)

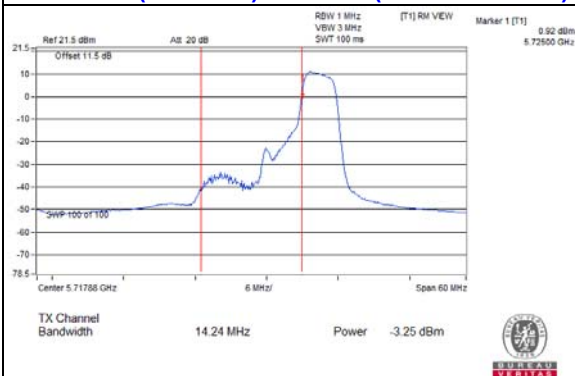

802.11ax (RU52/40) / CH144 (U-NII-3 Band)

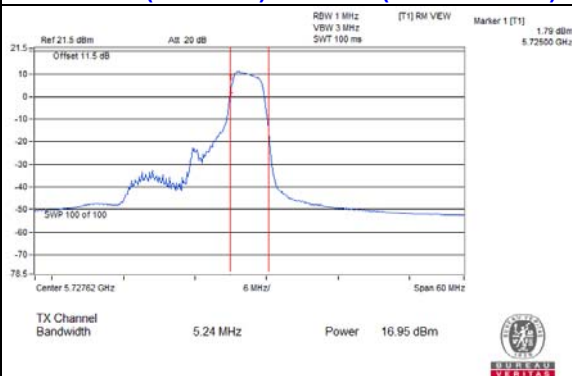

802.11ax (RU52/37) / CH144 (U-NII-2C Band)

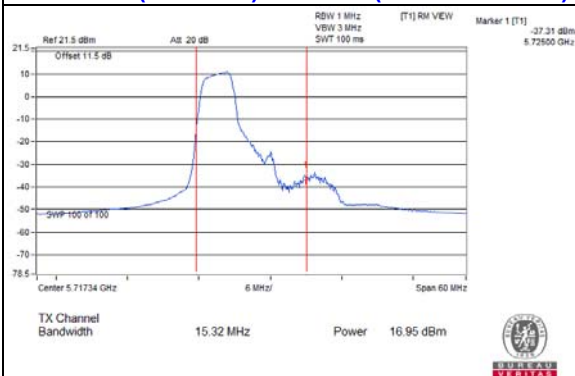

802.11ax (RU52/37) / CH144 (U-NII-3 Band)

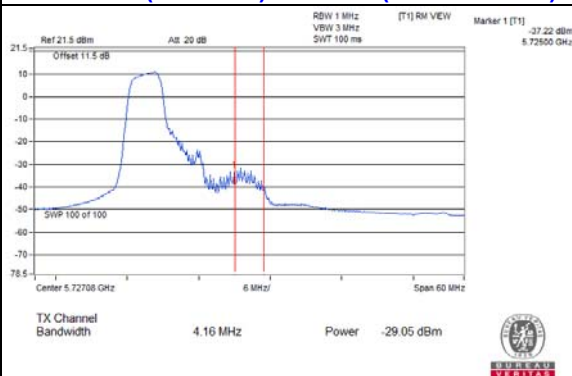

Spectrum Plot Value of Power

802.11ax (RU106/54) / CH144 (U-NII-2C Band)

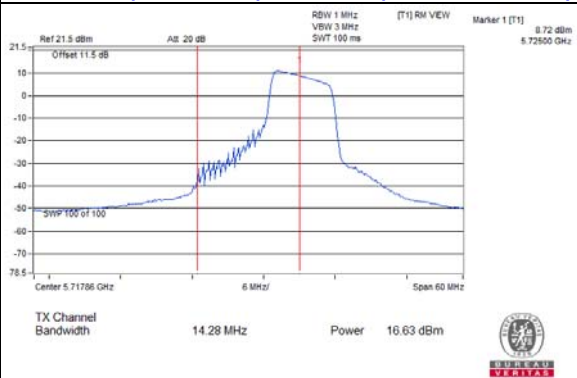

802.11ax (RU106/54) / CH144 (U-NII-3 Band)

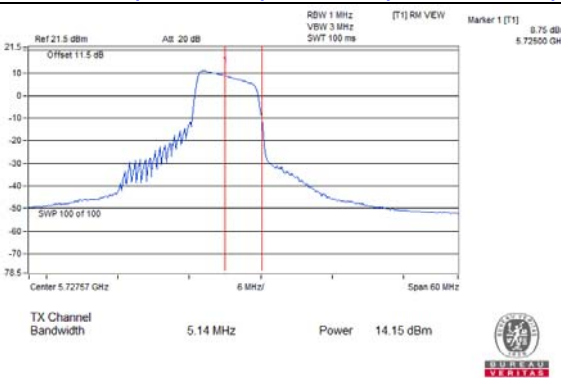

802.11ax (RU106/53) / CH144 (U-NII-2C Band)

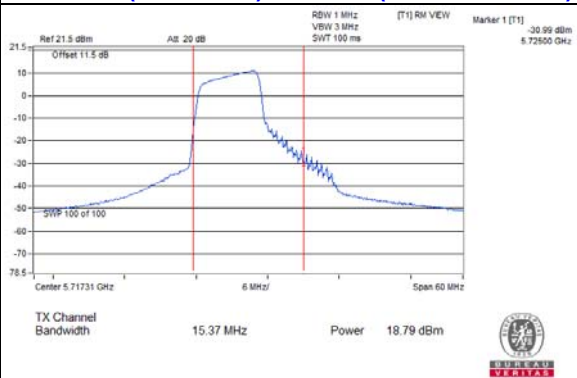

802.11ax (RU106/53) / CH144 (U-NII-3 Band)

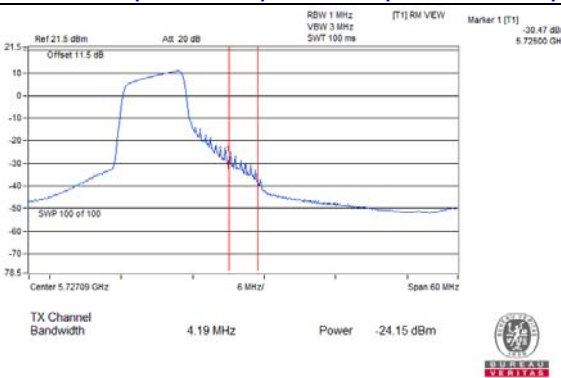

26dB OCCUPIED BANDWIDTH

802.11a

Channel	Frequency (MHz)	26dB Bandwidth (MHz)
52	5260	36.17
60	5300	36
64	5320	35.82
100	5500	20.89
116	5580	35.99
140	5700	18.49
144 (U-NII-2C Band)	5720	18.54

802.11ax (HE20)

Channel	Frequency (MHz)	26dB Bandwidth (MHz)
52	5260	28.22
60	5300	28.16
64	5320	20.47
100	5500	20.43
116	5580	27.88
140	5700	20.46
144 (U-NII-2C Band)	5720	18.67

802.11ax (HE40)

Channel	Frequency (MHz)	26dB Bandwidth (MHz)
54	5270	62.69
62	5310	40.74
102	5510	40.78
110	5550	63.6
134	5670	40.81
142 (U-NII-2C Band)	5710	40.65

802.11ax (HE80)

Channel	Frequency (MHz)	26dB Bandwidth (MHz)
58	5290	82.24
106	5530	82.19
122	5610	115.39
138 (U-NII-2C Band)	5690	77.68

802.11ax (RU26)

RU Configuration	Channel	Frequency (MHz)	26dB Bandwidth (MHz)
26/0	52	5260	19.62
26/4	60	5300	17.84
26/8	64	5320	19.53
26/0	100	5500	19.61
26/4	116	5580	17.81
26/8	140	5700	19.58
26/8	144 (U-NII-2C Band)	5720	14.18
26/0	144 (U-NII-2C Band)	5720	15.5

802.11ax (RU52)

RU Configuration	Channel	Frequency (MHz)	26dB Bandwidth (MHz)
52/37	52	5260	17.76
52/39	60	5300	15.96
52/40	64	5320	17.76
52/37	100	5500	17.76
52/39	116	5580	15.96
52/40	140	5700	17.88
52/40	144 (U-NII-2C Band)	5720	13.4
52/37	144 (U-NII-2C Band)	5720	15.32

802.11ax (RU106)

RU Configuration	Channel	Frequency (MHz)	26dB Bandwidth (MHz)
106/53	52	5260	19.55
106/54	60	5300	19.4
106/54	64	5320	19.39
106/53	100	5500	19.64
106/53	116	5580	19.63
106/54	140	5700	20.52
106/54	144 (U-NII-2C Band)	5720	14.28
106/53	144 (U-NII-2C Band)	5720	15.37

Spectrum Plot of Worst Value

802.11a / CH140

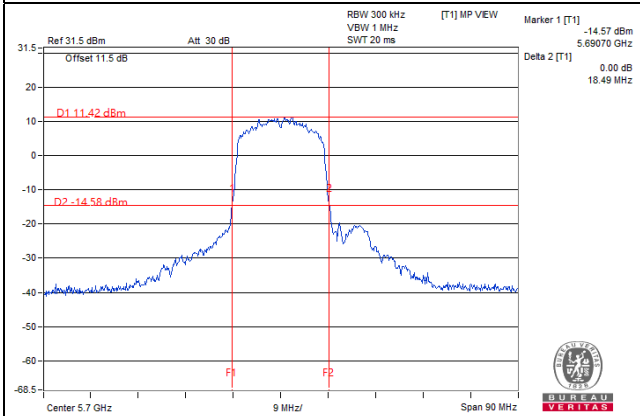

802.11ax (HE20) / CH144 (U-NII-2C Band)

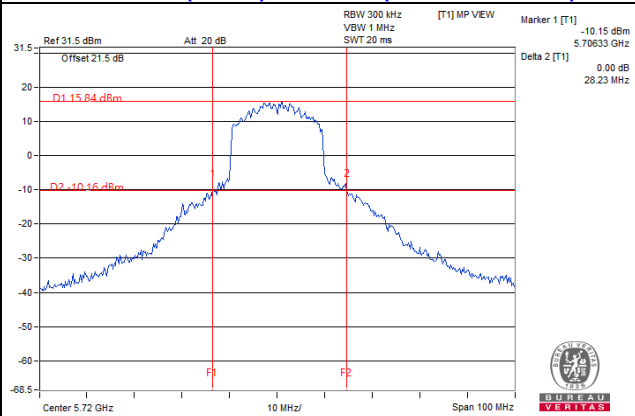

802.11ax (HE40) / CH142 (U-NII-2C Band)

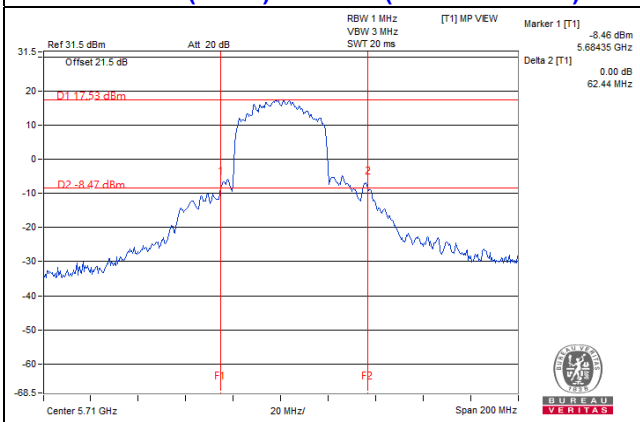

802.11ax (HE80) / CH138 (U-NII-2C Band)

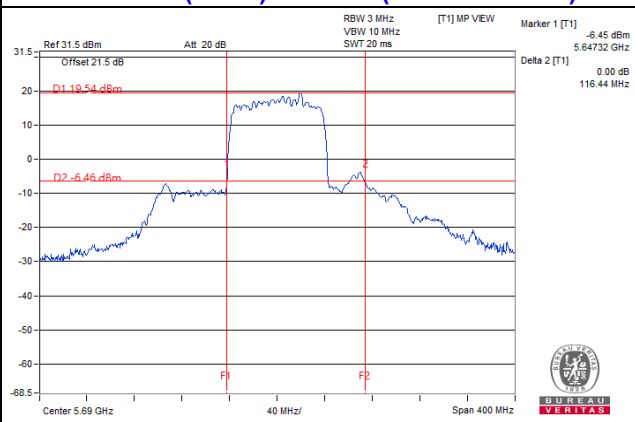

Note: For CH144 (U-NII-2C) = 5725MHz - Marker 1

Spectrum Plot of Worst Value

802.11ax (RU26) / CH144 (U-NII-2C Band)

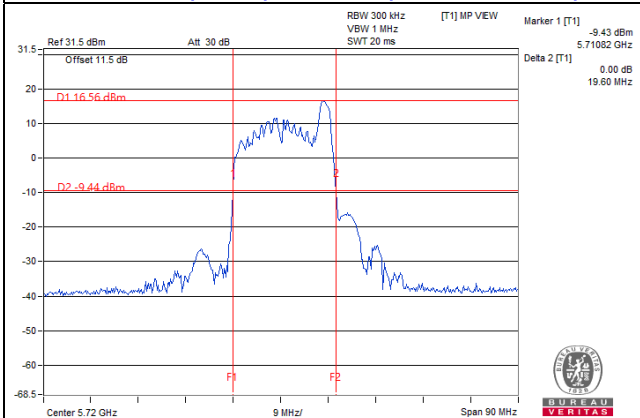

802.11ax (RU52) / CH144 (U-NII-2C Band)

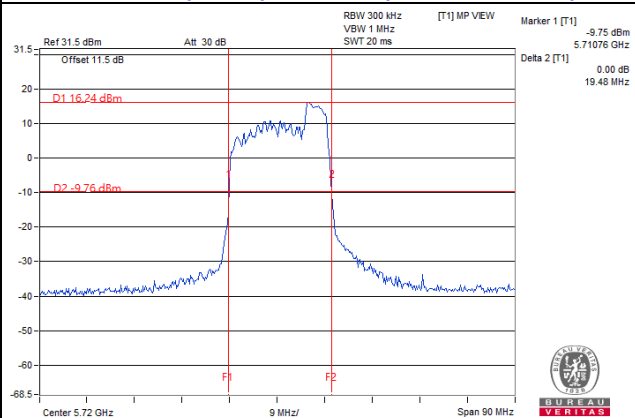

802.11ax (RU106) / CH144 (U-NII-2C Band)

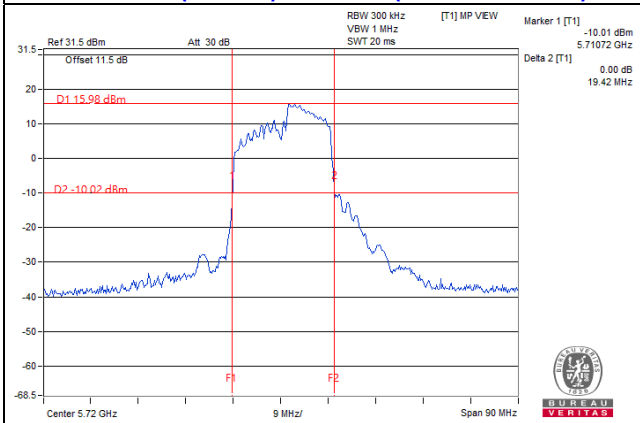

Note: For CH144 (U-NII-2C) = 5725MHz - Marker 1

For channel straddling 5725MHz of 26dB BW

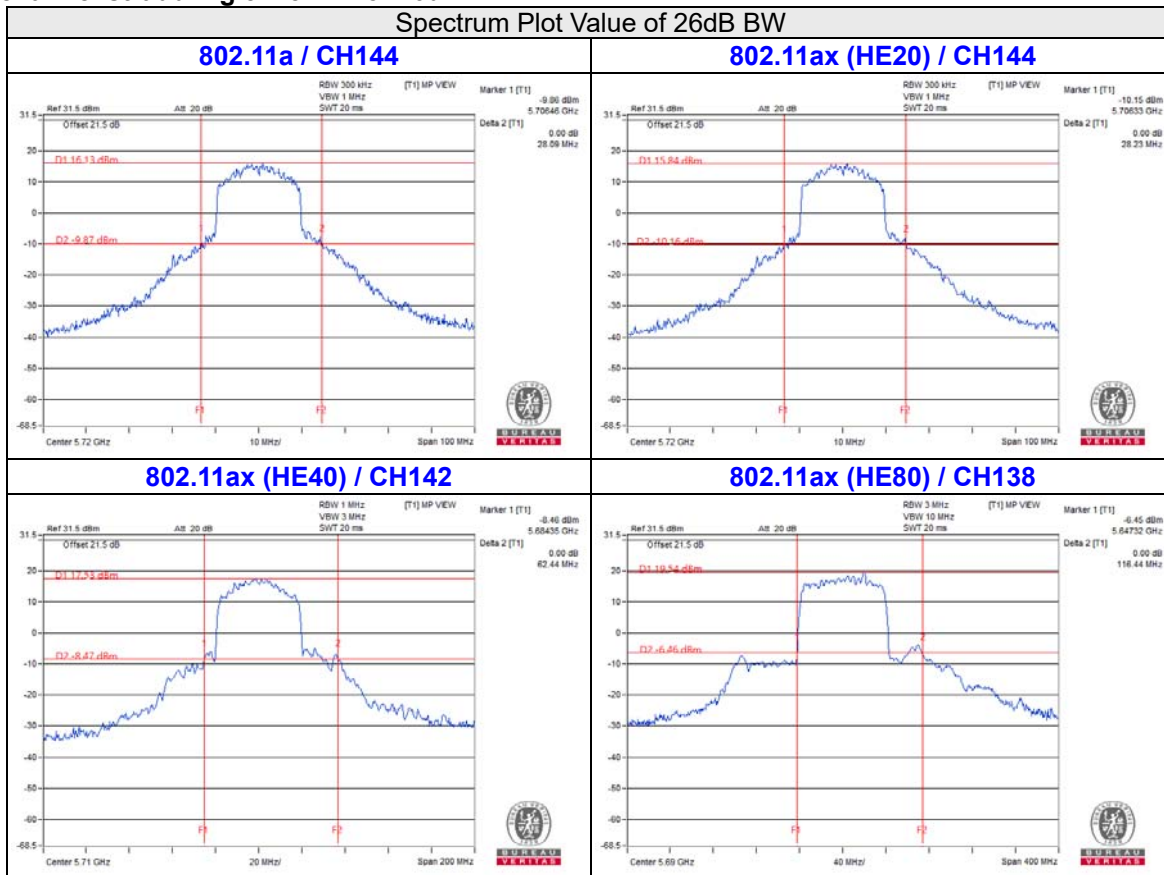

Note:

- For CH144 (U-NII-2C) = 5725MHz - Marker 1
- For CH142 (U-NII-2C) = 5725MHz - Marker 1
- For CH138 (U-NII-2C) = 5725MHz - Marker 1

Spectrum Plot of Worst Value

802.11ax (RU26/8) / CH144 (U-NII-2C Band)

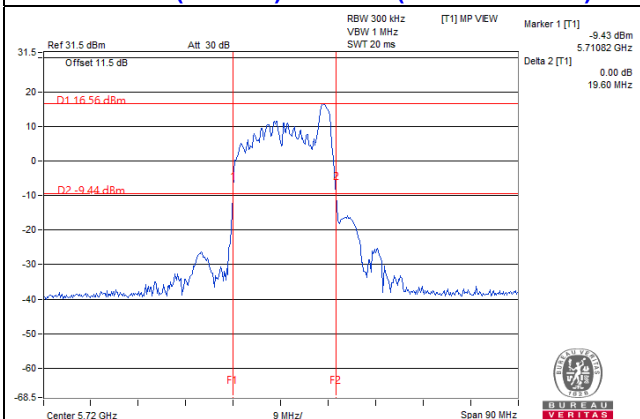

802.11ax (RU26/0) / CH144 (U-NII-2C Band)

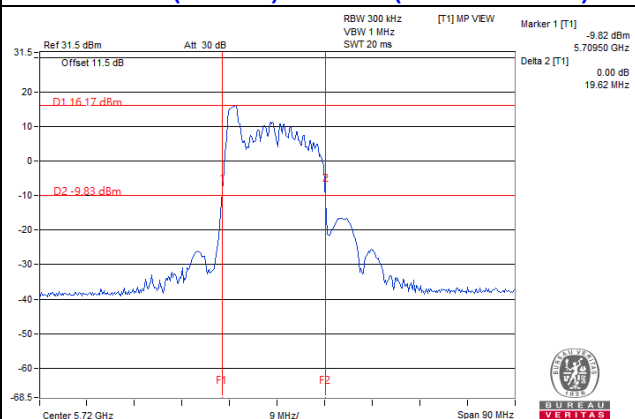

802.11ax (RU52/40) / CH144 (U-NII-2C Band)

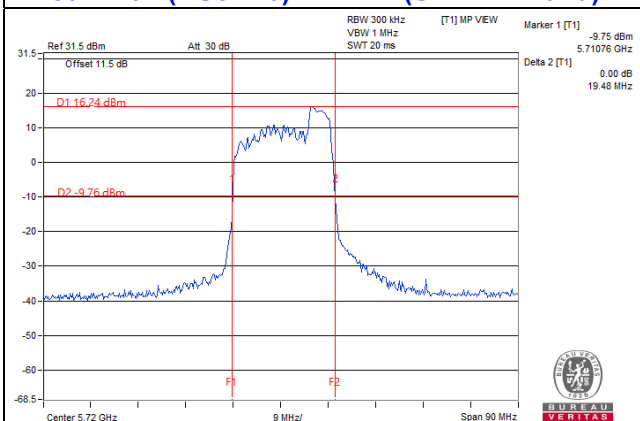

802.11ax (RU52/37) / CH144 (U-NII-2C Band)

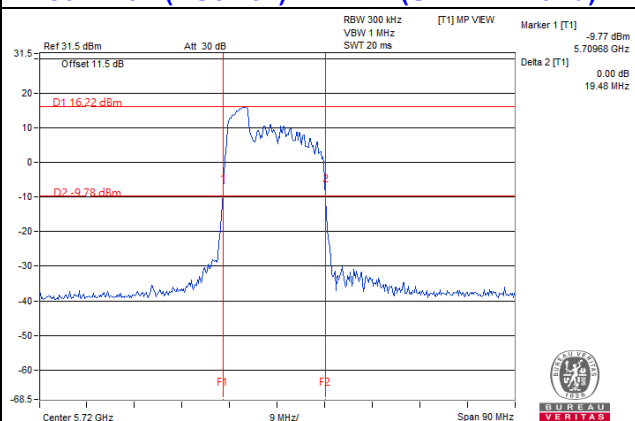

802.11ax (RU106/54) / CH144 (U-NII-2C Band)

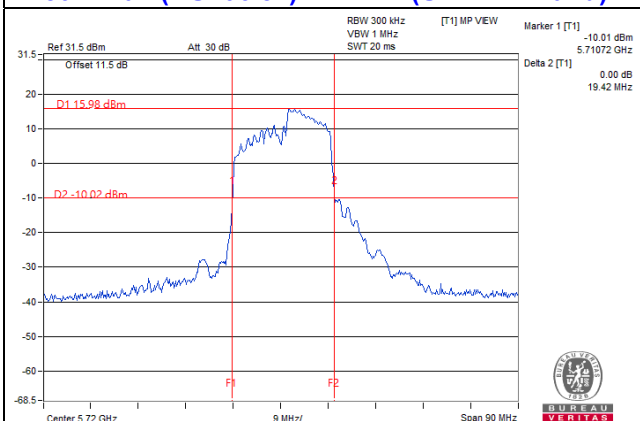

802.11ax (RU106/53) / CH144 (U-NII-2C Band)

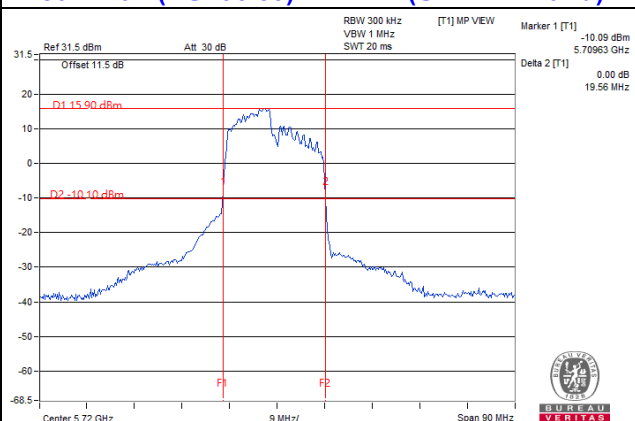

Note:

For CH144 (U-NII-2C) = 5725MHz - Marker 1

4.4 Occupied Bandwidth Measurement

4.4.1 Test Setup

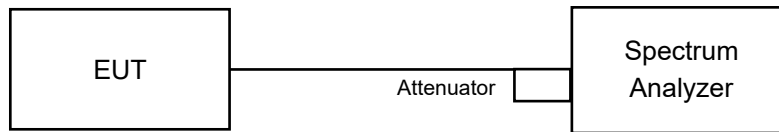

4.4.2 Test Instruments

Refer to section 4.1.2 to get information of above instrument.

4.4.3 Test Procedure

The transmitter output was connected to the spectrum analyzer through an attenuator. The bandwidth of the fundamental frequency was measured by spectrum analyzer with resolution bandwidth in the range of 1% to 5% of the anticipated emission bandwidth, and a video bandwidth at least 3x the resolution bandwidth and set the detector to SAMPLE. The width of a frequency band such that, below the lower and above the upper frequency limits, the mean powers emitted are each equal to a specified percentage 0.5% of the total mean power of a given emission.

4.4.4 Test Results (Mode 1)

CDD Mode

802.11a

Channel	Frequency (MHz)	Occupied Bandwidth (MHz)	
		Chain 0	Chain 1
36	5180	16.2	16.2
40	5200	16.2	16.2
48	5240	16.2	16.2
52	5260	16.2	16.2
60	5300	16.2	16.2
64	5320	16.2	16.2
100	5500	16.2	16.2
116	5580	16.2	16.2
140	5700	16.2	16.2
144 (U-NII-2C Band)	5720	13.16	13.16
144 (U-NII-3 Band)	5720	3.04	3.04
149	5745	16.68	17.76
157	5785	17.28	18.96
165	5825	16.68	17.64

802.11ax (HE20)

Channel	Frequency (MHz)	Occupied Bandwidth (MHz)	
		Chain 0	Chain 1
36	5180	18.6	18.6
40	5200	18.6	18.6
48	5240	18.6	18.6
52	5260	18.6	18.6
60	5300	18.6	18.6
64	5320	18.6	18.6
100	5500	18.6	18.6
116	5580	18.65	18.65
140	5700	18.6	18.6
144 (U-NII-2C Band)	5720	14.36	14.36
144 (U-NII-3 Band)	5720	4.24	4.24
149	5745	18.84	18.96
157	5785	18.84	18.96
165	5825	18.84	18.96

802.11ax (HE40)

Channel	Frequency (MHz)	Occupied Bandwidth (MHz)	
		Chain 0	Chain 1
38	5190	37.2	37.2
46	5230	37.44	37.2
54	5270	37.44	37.44
62	5310	37.2	37.2
102	5510	36.96	37.2
110	5550	37.44	37.44
134	5670	37.2	37.2
142 (U-NII-2C Band)	5710	33.72	33.72
142 (U-NII-3 Band)	5710	3.72	3.72
151	5755	37.44	37.44
159	5795	37.44	37.68

802.11ax (HE80)

Channel	Frequency (MHz)	Occupied Bandwidth (MHz)	
		Chain 0	Chain 1
42	5210	76.8	77.28
58	5290	76.8	76.8
106	5530	77.28	77.76
122	5610	77.76	77.28
138 (U-NII-2C Band)	5690	73.88	73.88
138 (U-NII-3 Band)	5690	3.88	3.4
155	5775	77.28	77.28

802.11ax (RU26)

RU Configuration	Channel	Frequency (MHz)	Occupied Bandwidth (MHz)	
			Chain 0	Chain 1
26/0	36	5180	17.88	17.76
26/4	40	5200	14.88	14.88
26/8	48	5240	17.88	17.88
26/0	52	5260	17.76	17.76
26/4	60	5300	14.76	14.88
26/8	64	5320	17.88	17.88
26/0	100	5500	17.76	17.76
26/4	116	5580	14.88	14.88
26/8	140	5700	18	17.88
26/8	144 (U-NII-2C Band)	5720	13.28	13.28
26/8	144 (U-NII-3 Band)	5720	4.6	4.6
26/0	144 (U-NII-2C Band)	5720	14.72	14.72
26/0	144 (U-NII-3 Band)	5720	3.16	3.04
26/0	149	5745	18.09	18.24
26/4	157	5785	15.36	15.48
26/8	165	5825	18.12	18

802.11ax (RU52)

RU Configuration	Channel	Frequency (MHz)	Occupied Bandwidth (MHz)	
			Chain 0	Chain 1
52/37	36	5180	17.76	17.52
52/39	40	5200	15.96	15.72
52/40	48	5240	17.88	17.76
52/37	52	5260	17.76	17.64
52/39	60	5300	15.84	15.72
52/40	64	5320	17.88	17.76
52/37	100	5500	17.76	17.64
52/39	116	5580	16.08	15.72
52/40	140	5700	17.88	17.76
52/40	144 (U-NII-2C Band)	5720	13.4	13.28
52/40	144 (U-NII-3 Band)	5720	4.48	4.48
52/37	144 (U-NII-2C Band)	5720	14.6	14.6
52/37	144 (U-NII-3 Band)	5720	3.04	3.16
52/37	149	5745	18	18
52/39	157	5785	16.44	16.2
52/40	165	5825	18.24	18.12

802.11ax (RU106)

RU Configuration	Channel	Frequency (MHz)	Occupied Bandwidth (MHz)	
			Chain 0	Chain 1
106/53	36	5180	17.52	17.52
106/53	40	5200	17.64	17.52
106/54	48	5240	17.64	17.52
106/53	52	5260	17.52	17.64
106/54	60	5300	17.64	17.64
106/54	64	5320	17.64	17.64
106/53	100	5500	17.64	17.64
106/53	116	5580	17.52	17.64
106/54	140	5700	17.64	17.64
106/54	144 (U-NII-2C Band)	5720	13.28	13.16
106/54	144 (U-NII-3 Band)	5720	4.36	4.36
106/53	144 (U-NII-2C Band)	5720	14.6	14.48
106/53	144 (U-NII-3 Band)	5720	2.92	3.04
106/53	149	5745	17.76	17.88
106/54	157	5785	18	18.24
106/54	165	5825	18	18.48

Spectrum Plot of Max. Value

802.11a_Chain 1 / CH157

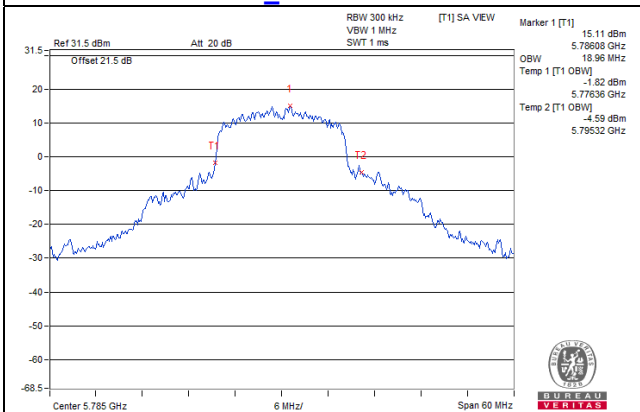

802.11ax (HE20)_Chain 1 / CH149

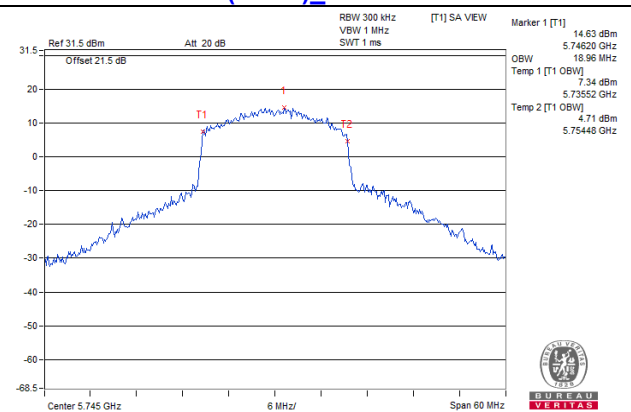

802.11ax (HE40)_Chain 1 / CH159

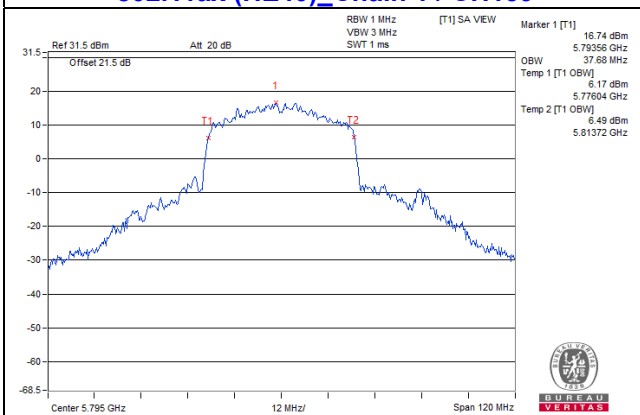

802.11ax (HE80)_Chain 0 / CH122

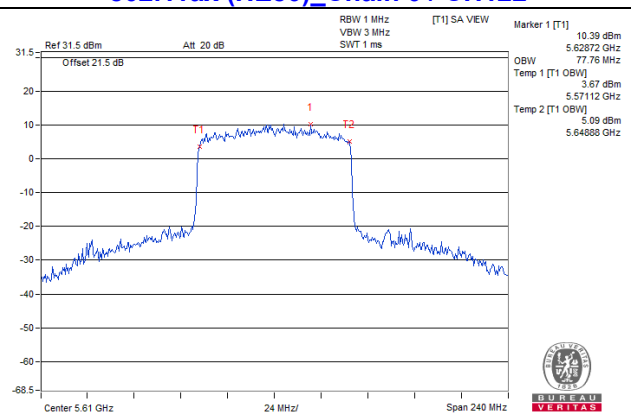

802.11ax (RU26)_Chain 0 / CH149

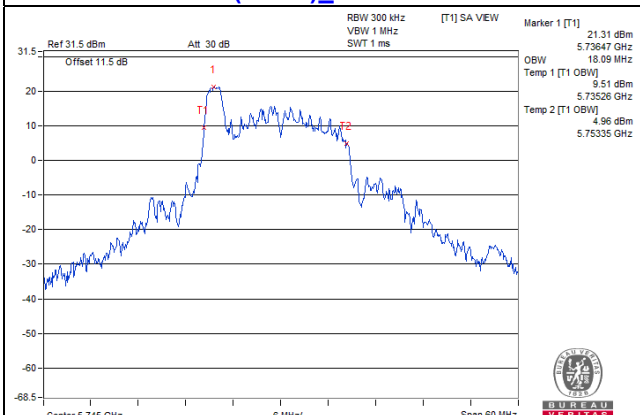

802.11ax (RU52)_Chain 0 / CH165

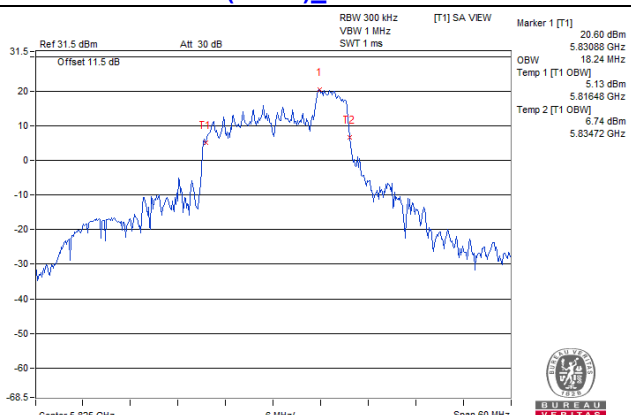

802.11ax (RU106)_Chain 1 / CH165

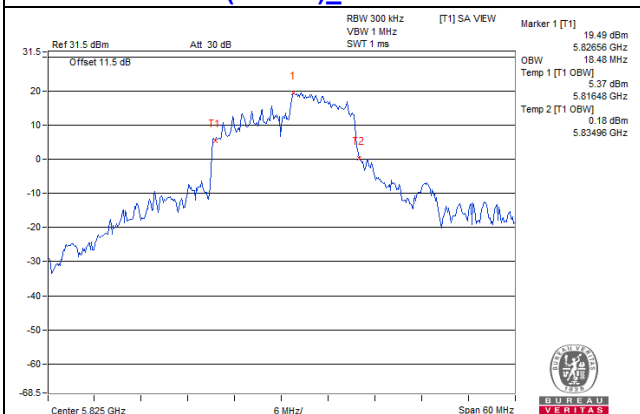

4.4.5 Test Results (Mode 2)

802.11a

Channel	Frequency (MHz)	Occupied Bandwidth (MHz)
36	5180	16.56
40	5200	16.56
48	5240	16.68
52	5260	16.8
60	5300	16.68
64	5320	16.92
100	5500	16.32
116	5580	16.92
140	5700	16.2
144 (U-NII-2C Band)	5720	13.4
144 (U-NII-3 Band)	5720	3.88
149	5745	17.76
157	5785	17.76
165	5825	17.64

802.11ax (HE20)

Channel	Frequency (MHz)	Occupied Bandwidth (MHz)
36	5180	18.84
40	5200	18.84
48	5240	18.84
52	5260	18.84
60	5300	18.84
64	5320	18.72
100	5500	18.6
116	5580	18.84
140	5700	18.6
144 (U-NII-2C Band)	5720	14.6
144 (U-NII-3 Band)	5720	4.48
149	5745	19.08
157	5785	19.08
165	5825	18.96

802.11ax (HE40)

Channel	Frequency (MHz)	Occupied Bandwidth (MHz)
38	5190	37.2
46	5230	37.68
54	5270	37.44
62	5310	37.2
102	5510	37.2
110	5550	37.68
134	5670	37.2
142 (U-NII-2C Band)	5710	33.96
142 (U-NII-3 Band)	5710	3.96
151	5755	37.68
159	5795	37.92

802.11ax (HE80)

Channel	Frequency (MHz)	Occupied Bandwidth (MHz)
42	5210	76.8
58	5290	77.28
106	5530	76.8
122	5610	77.76
138 (U-NII-2C Band)	5690	73.88
138 (U-NII-3 Band)	5690	3.88
155	5775	77.76

802.11ax (RU26)

RU Configuration	Channel	Frequency (MHz)	Occupied Bandwidth (MHz)
26/0	36	5180	18.48
26/4	40	5200	14.64
26/8	48	5240	17.88
26/0	52	5260	17.88
26/4	60	5300	14.88
26/8	64	5320	17.88
26/0	100	5500	17.88
26/4	116	5580	14.76
26/8	140	5700	17.88
26/8	144 (U-NII-2C Band)	5720	13.28
26/8	144 (U-NII-3 Band)	5720	4.6
26/0	144 (U-NII-2C Band)	5720	14.72
26/0	144 (U-NII-3 Band)	5720	3.16
26/0	149	5745	18.36
26/4	157	5785	15.12
26/8	165	5825	18.24

802.11ax (RU52)

RU Configuration	Channel	Frequency (MHz)	Occupied Bandwidth (MHz)
52/37	36	5180	17.76
52/39	40	5200	15.84
52/40	48	5240	17.76
52/37	52	5260	17.76
52/39	60	5300	15.96
52/40	64	5320	17.76
52/37	100	5500	17.76
52/39	116	5580	15.96
52/40	140	5700	17.88
52/40	144 (U-NII-2C Band)	5720	13.4
52/40	144 (U-NII-3 Band)	5720	4.48
52/37	144 (U-NII-2C Band)	5720	14.6
52/37	144 (U-NII-3 Band)	5720	3.16
52/37	149	5745	18
52/39	157	5785	16.44
52/40	165	5825	18.24

802.11ax (RU106)

RU Configuration	Channel	Frequency (MHz)	Occupied Bandwidth (MHz)
106/53	36	5180	17.64
106/53	40	5200	17.64
106/54	48	5240	17.64
106/53	52	5260	17.52
106/54	60	5300	17.64
106/54	64	5320	17.64
106/53	100	5500	17.64
106/53	116	5580	17.64
106/54	140	5700	17.64
106/54	144 (U-NII-2C Band)	5720	13.28
106/54	144 (U-NII-3 Band)	5720	4.36
106/53	144 (U-NII-2C Band)	5720	14.6
106/53	144 (U-NII-3 Band)	5720	3.04
106/53	149	5745	17.76
106/54	157	5785	17.88
106/54	165	5825	17.88

Spectrum Plot of Max. Value

802.11a / CH149

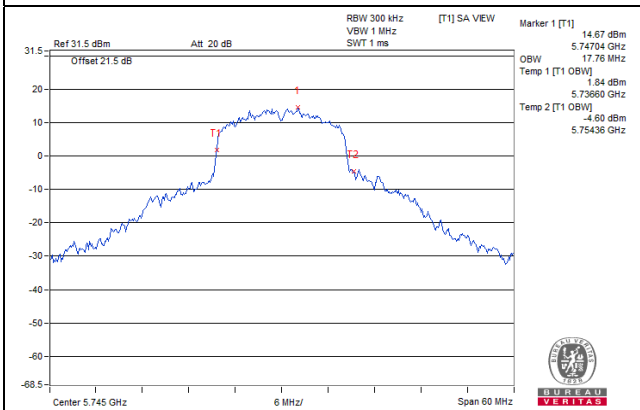

802.11ax (HE20) / CH149

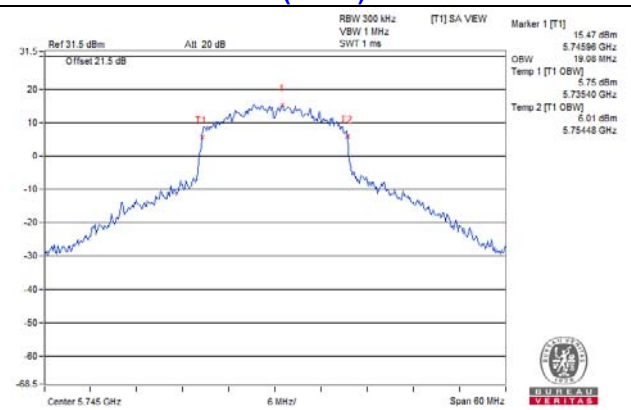

802.11ax (HE40) / CH159

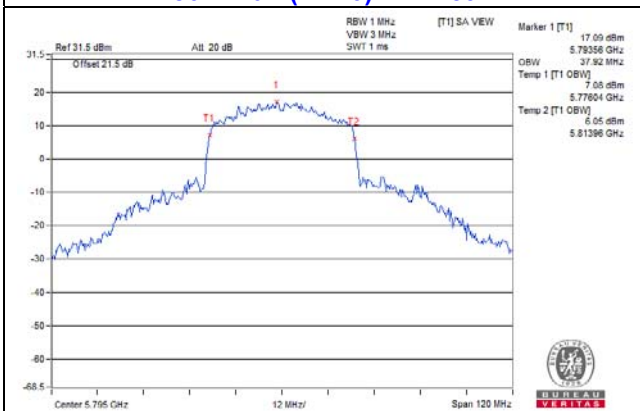

802.11ax (HE80) / CH122

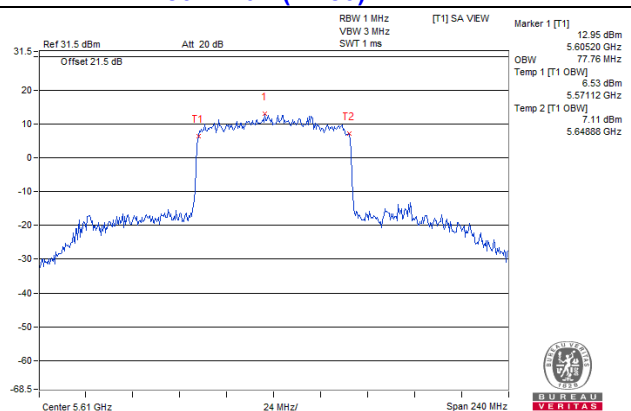

802.11ax (RU26) / CH36

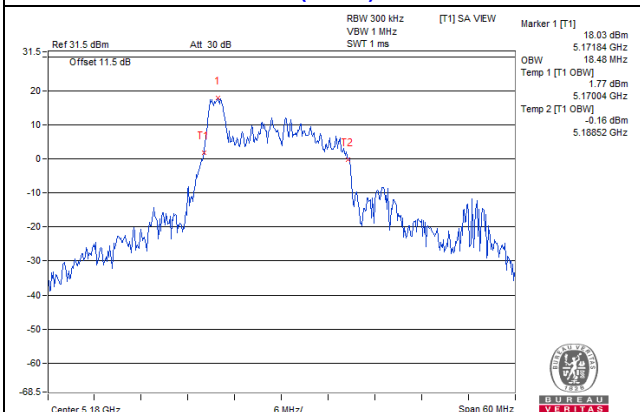

802.11ax (RU52) / CH165

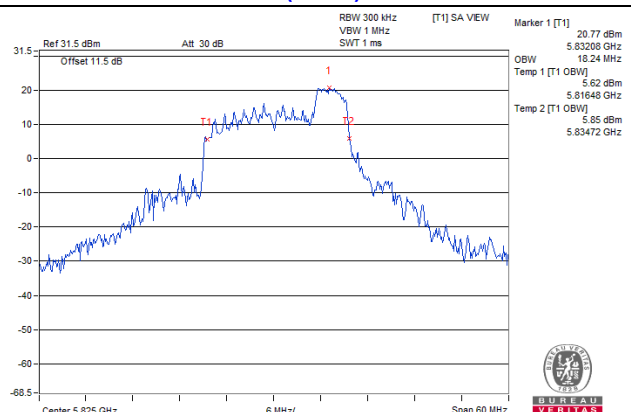

802.11ax (RU106) / CH157

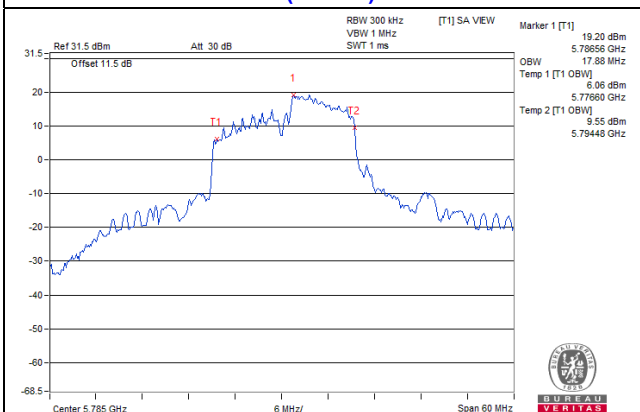

4.5 Peak Power Spectral Density Measurement

4.5.1 Limits of Peak Power Spectral Density Measurement

Operation Band	EUT Category		Limit
U-NII-1		Outdoor Access Point	17dBm/ MHz
		Fixed point-to-point Access Point	
		Indoor Access Point	
	√	Client device	11dBm/ MHz
U-NII-2A		√	11dBm/ MHz
U-NII-2C		√	11dBm/ MHz
U-NII-3		√	30dBm/ 500kHz

4.5.2 Test Setup

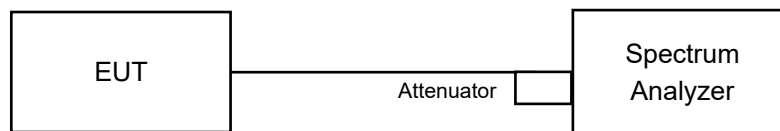

4.5.3 Test Instruments

Refer to section 4.1.2 to get information of above instrument.

4.5.4 Test Procedure

For U-NII-1, U-NII-2A, U-NII-2C band:

Using method SA-1

1. Set span to encompass the entire emission bandwidth (EBW) of the signal.
2. Set RBW = 1 MHz, Set VBW ≥ 3 MHz, Detector = RMS
3. Sweep time = auto, trigger set to "free run".
4. Trace average at least 100 traces in power averaging mode.
5. Record the max value

For U-NII-3 band:

1. Set span to encompass the entire emission bandwidth (EBW) of the signal.
2. Set RBW = 300 kHz, Set VBW ≥ 1 MHz, Detector = RMS
3. Use the peak marker function to determine the maximum power level in any 300 kHz band segment within the fundamental EBW.
4. Scale the observed power level to an equivalent value in 500 kHz by adjusting (increasing) the measured power by a bandwidth correction factor (BWCF) where $BWCF = 10\log(500\text{ kHz}/300\text{ kHz})$
5. Sweep time = auto, trigger set to "free run".
6. Trace average at least 100 traces in power averaging mode.
7. Record the max value

4.5.5 Deviation from Test Standard

No deviation.

4.5.6 EUT Operating Condition

Same as Item 4.3.6.

4.5.7 Test Results (Mode 1)

For U-NII-1, U-NII-2A, U-NII-2C band:

CDD Mode

802.11a

Chan.	Chan. Freq. (MHz)	PSD (dBm/MHz)		Total PSD (dBm/MHz)	Max. PSD Limit (dBm/MHz)	Pass / Fail
		Chain 0	Chain 1			
36	5180	6.01	5.22	8.64	8.99	Pass
40	5200	6.02	5.25	8.66	8.99	Pass
48	5240	5.74	5.15	8.47	8.99	Pass
52	5260	6.19	5.65	8.94	8.99	Pass
60	5300	5.99	5.55	8.79	8.99	Pass
64	5320	6.12	5.55	8.85	8.99	Pass
100	5500	5.18	4.76	7.99	8.99	Pass
116	5580	5.94	5.73	8.85	8.99	Pass
140	5700	4.84	5.13	8.00	8.99	Pass
144 (U-NII-2C Band)	5720	5.55	5.88	8.73	8.99	Pass

- Note: 1. Method a) of power density measurement of KDB 662911 is using for calculating total power density. Total power density is summing entire spectra across corresponding frequency bins on the various outputs by computer.
2. The directional gain is $5 \text{ dBi} + 10\log(2) = 8.01 \text{ dBi} > 6\text{dBi}$, so the power density limit shall be reduced to $11-(8.01-6) = 8.99 \text{ dBm}$.

802.11ax (HE20)

Chan.	Chan. Freq. (MHz)	PSD (dBm/MHz)		Total PSD (dBm/MHz)	Max. PSD Limit (dBm/MHz)	Pass / Fail
		Chain 0	Chain 1			
36	5180	6.17	5.23	8.74	8.99	Pass
40	5200	6.20	5.26	8.77	8.99	Pass
48	5240	6.06	5.23	8.68	8.99	Pass
52	5260	5.94	5.44	8.71	8.99	Pass
60	5300	5.92	5.36	8.66	8.99	Pass
64	5320	6.02	5.32	8.69	8.99	Pass
100	5500	5.59	5.08	8.35	8.99	Pass
116	5580	6.04	5.76	8.91	8.99	Pass
140	5700	5.42	5.67	8.56	8.99	Pass
144 (U-NII-2C Band)	5720	5.38	5.97	8.70	8.99	Pass

- Note: 1. Method a) of power density measurement of KDB 662911 is using for calculating total power density. Total power density is summing entire spectra across corresponding frequency bins on the various outputs by computer.
2. The directional gain is $5 \text{ dBi} + 10\log(2) = 8.01 \text{ dBi} > 6\text{dBi}$, so the power density limit shall be reduced to $11-(8.01-6) = 8.99 \text{ dBm}$.

802.11ax (HE40)

Chan.	Chan. Freq. (MHz)	PSD (dBm/MHz)		Total PSD (dBm/MHz)	Max. PSD Limit (dBm/MHz)	Pass / Fail
		Chain 0	Chain 1			
38	5190	1.81	1.20	4.53	8.99	Pass
46	5230	5.79	5.32	8.57	8.99	Pass
54	5270	5.78	5.58	8.69	8.99	Pass
62	5310	1.84	1.61	4.74	8.99	Pass
102	5510	0.46	0.20	3.34	8.99	Pass
110	5550	5.68	5.82	8.76	8.99	Pass
134	5670	2.08	2.78	5.45	8.99	Pass
142 (U-NII-2C Band)	5710	5.06	5.69	8.40	8.99	Pass

- Note: 1. Method a) of power density measurement of KDB 662911 is using for calculating total power density. Total power density is summing entire spectra across corresponding frequency bins on the various outputs by computer.
2. The directional gain is $5 \text{ dBi} + 10\log(2) = 8.01 \text{ dBi} > 6\text{dBi}$, so the power density limit shall be reduced to $11-(8.01-6) = 8.99 \text{ dBm}$.

802.11ax (HE80)

Chan.	Chan. Freq. (MHz)	PSD (dBm/MHz)		Total PSD (dBm/MHz)	Max. PSD Limit (dBm/MHz)	Pass / Fail
		Chain 0	Chain 1			
42	5210	-3.60	-4.55	-1.04	8.99	Pass
58	5290	-2.10	-2.55	0.69	8.99	Pass
106	5530	-4.01	-4.37	-1.18	8.99	Pass
122	5610	-0.02	-0.19	2.91	8.99	Pass
138 (U-NII-2C Band)	5690	0.77	1.08	3.94	8.99	Pass

- Note: 1. Method a) of power density measurement of KDB 662911 is using for calculating total power density. Total power density is summing entire spectra across corresponding frequency bins on the various outputs by computer.
2. The directional gain is $5 \text{ dBi} + 10\log(2) = 8.01 \text{ dBi} > 6\text{dBi}$, so the power density limit shall be reduced to $11-(8.01-6) = 8.99 \text{ dBm}$.

802.11ax (RU26)

RU Configuration	Chan.	Chan. Freq. (MHz)	PSD (dBm/MHz)		Total PSD (dBm/MHz)	Max. PSD Limit (dBm/MHz)	Pass / Fail
			Chain 0	Chain 1			
26/0	36	5180	5.50	6.17	8.86	8.99	Pass
26/4	40	5200	5.78	5.74	8.77	8.99	Pass
26/8	48	5240	5.31	6.45	8.93	8.99	Pass
26/0	52	5260	5.29	6.43	8.91	8.99	Pass
26/4	60	5300	5.66	5.88	8.78	8.99	Pass
26/8	64	5320	5.14	6.49	8.88	8.99	Pass
26/0	100	5500	5.16	6.41	8.84	8.99	Pass
26/4	116	5580	5.84	6.09	8.98	8.99	Pass
26/8	140	5700	5.12	6.68	8.98	8.99	Pass
26/8	144 (U-NII-2C Band)	5720	-20.82	-19.03	-16.82	8.99	Pass
26/0	144 (U-NII-2C Band)	5720	5.22	6.35	8.83	8.99	Pass

- Note: 1. Method a) of power density measurement of KDB 662911 is using for calculating total power density. Total power density is summing entire spectra across corresponding frequency bins on the various outputs by computer.
2. The directional gain is $5 \text{ dBi} + 10\log(2) = 8.01 \text{ dBi} > 6\text{dBi}$, so the power density limit shall be reduced to $11-(8.01-6) = 8.99 \text{ dBm}$.

802.11ax (RU52)

RU Configuration	Chan.	Chan. Freq. (MHz)	PSD (dBm/MHz)		Total PSD (dBm/MHz)	Max. PSD Limit (dBm/MHz)	Pass / Fail
			Chain 0	Chain 1			
52/37	36	5180	5.55	5.93	8.75	8.99	Pass
52/39	40	5200	6.02	5.87	8.96	8.99	Pass
52/40	48	5240	4.77	5.99	8.43	8.99	Pass
52/37	52	5260	5.28	5.99	8.66	8.99	Pass
52/39	60	5300	5.86	5.94	8.91	8.99	Pass
52/40	64	5320	4.86	6.22	8.60	8.99	Pass
52/37	100	5500	5.47	6.23	8.88	8.99	Pass
52/39	116	5580	5.75	5.97	8.87	8.99	Pass
52/40	140	5700	4.17	6.02	8.20	8.99	Pass
52/40	144 (U-NII-2C Band)	5720	-6.59	-4.82	-2.61	8.99	Pass
52/37	144 (U-NII-2C Band)	5720	6.37	5.33	8.89	8.99	Pass

- Note: 1. Method a) of power density measurement of KDB 662911 is using for calculating total power density. Total power density is summing entire spectra across corresponding frequency bins on the various outputs by computer.
2. The directional gain is $5 \text{ dBi} + 10\log(2) = 8.01 \text{ dBi} > 6\text{dBi}$, so the power density limit shall be reduced to $11-(8.01-6) = 8.99 \text{ dBm}$.

802.11ax (RU106)

RU Configuration	Chan.	Chan. Freq. (MHz)	PSD (dBm/MHz)		Total PSD (dBm/MHz)	Max. PSD Limit (dBm/MHz)	Pass / Fail
			Chain 0	Chain 1			
106/53	36	5180	5.66	5.77	8.73	8.99	Pass
106/53	40	5200	5.70	5.84	8.78	8.99	Pass
106/54	48	5240	5.89	5.85	8.88	8.99	Pass
106/53	52	5260	5.51	5.90	8.72	8.99	Pass
106/54	60	5300	5.85	5.84	8.86	8.99	Pass
106/54	64	5320	5.73	5.94	8.85	8.99	Pass
106/53	100	5500	5.37	5.91	8.66	8.99	Pass
106/53	116	5580	5.45	6.02	8.75	8.99	Pass
106/54	140	5700	5.28	5.95	8.64	8.99	Pass
106/54	144 (U-NII-2C Band)	5720	5.32	5.93	8.65	8.99	Pass
106/53	144 (U-NII-2C Band)	5720	5.57	4.84	8.23	8.99	Pass

- Note: 1. Method a) of power density measurement of KDB 662911 is using for calculating total power density. Total power density is summing entire spectra across corresponding frequency bins on the various outputs by computer.
2. The directional gain is $5 \text{ dBi} + 10\log(2) = 8.01 \text{ dBi} > 6\text{dBi}$, so the power density limit shall be reduced to $11 - (8.01 - 6) = 8.99 \text{ dBm}$.

Spectrum Plot of Worst Value

802.11a_Chain 0 / CH52

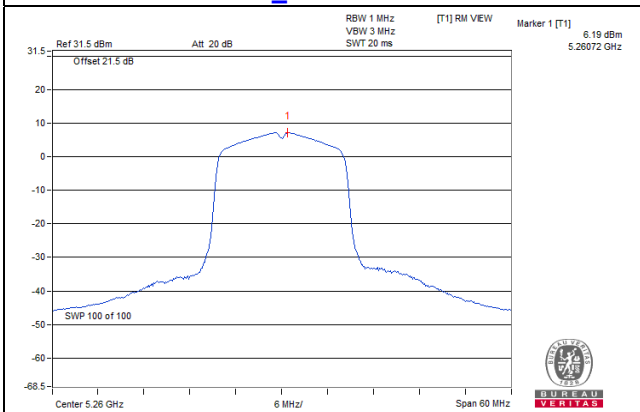

802.11ax (HE20)_Chain 0 / CH40

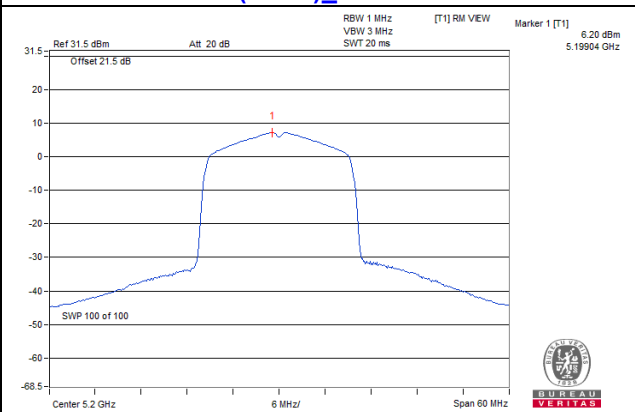

802.11ax (HE40)_Chain 0 / CH46

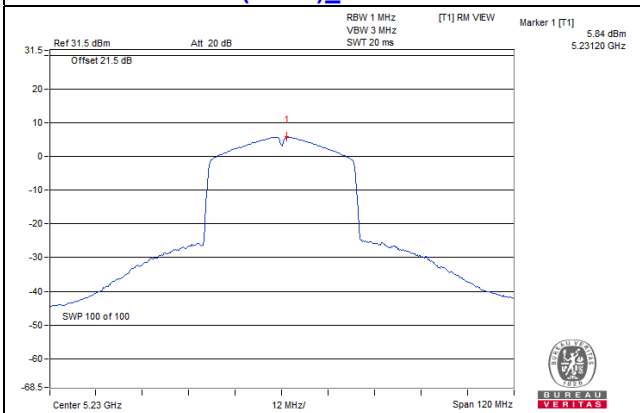

802.11ax (HE80)_Chain 1 / CH138 (U-NII-2C Band)

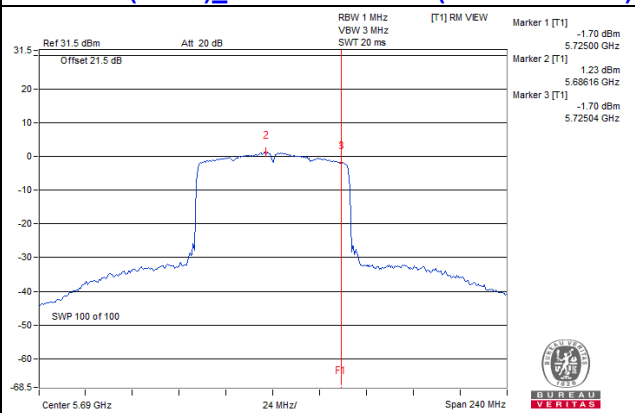

802.11ax (RU26)_Chain 1 / CH140

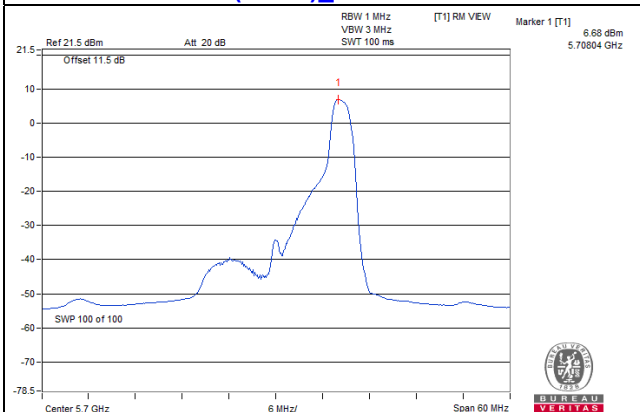

802.11ax (RU52)_Chain 0 / CH144 (U-NII-2C Band)

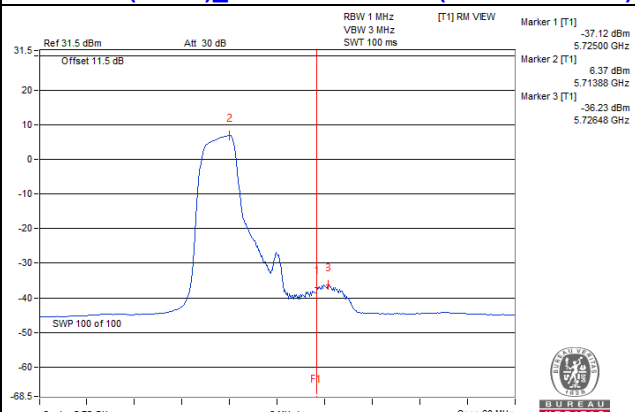

802.11ax (RU106)_Chain 1 / CH116

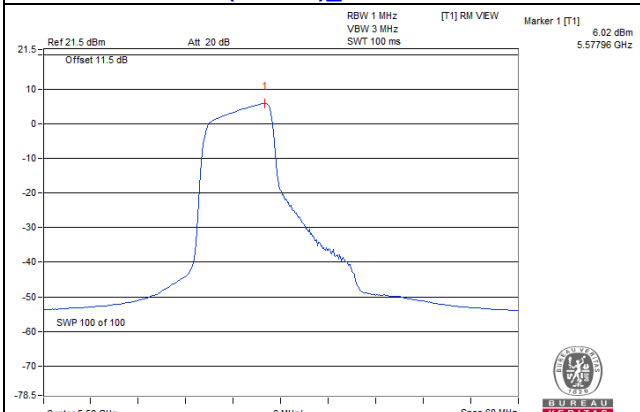

For U-NII-3 band:

CDD Mode

802.11a

Chan.	Chan. Freq. (MHz)	PSD (dBm/300kHz)		Total PSD (dBm/300kHz)	Total PSD (dBm/500kHz)	PSD Limit (dBm/500kHz)	Pass / Fail
		Chain 0	Chain 1				
144 (U-NII-3 Band)	5720	-5.03	-4.72	-1.86	0.36	27.99	Pass
149	5745	1.18	1.92	4.58	6.80	27.99	Pass
157	5785	1.54	2.57	5.10	7.32	27.99	Pass
165	5825	2.10	2.49	5.31	7.53	27.99	Pass

- Note: 1. Method b) Measure and sum spectral maxima across the outputs of KDB 662911 is using for calculating total power density.
 2. The directional gain is $5 \text{ dBi} + 10\log(2) = 8.01 \text{ dBi} > 6\text{dBi}$, so the power density limit shall be reduced to $30-(8.01-6) = 27.99 \text{ dBm}$.

802.11ax (HE20)

Chan.	Chan. Freq. (MHz)	PSD (dBm/300kHz)		Total PSD (dBm/300kHz)	Total PSD (dBm/500kHz)	PSD Limit (dBm/500kHz)	Pass / Fail
		Chain 0	Chain 1				
144 (U-NII-3 Band)	5720	-5.61	-4.92	-2.24	-0.02	27.99	Pass
149	5745	0.34	0.87	3.62	5.84	27.99	Pass
157	5785	0.33	0.86	3.61	5.83	27.99	Pass
165	5825	0.69	0.93	3.82	6.04	27.99	Pass

- Note: 1. Method b) Measure and sum spectral maxima across the outputs of KDB 662911 is using for calculating total power density.
 2. The directional gain is $5 \text{ dBi} + 10\log(2) = 8.01 \text{ dBi} > 6\text{dBi}$, so the power density limit shall be reduced to $30-(8.01-6) = 27.99 \text{ dBm}$.

802.11ax (HE40)

Chan.	Chan. Freq. (MHz)	PSD (dBm/300kHz)		Total PSD (dBm/300kHz)	Total PSD (dBm/500kHz)	PSD Limit (dBm/500kHz)	Pass / Fail
		Chain 0	Chain 1				
142 (U-NII-3 Band)	5710	-9.05	-8.26	-5.63	-3.41	27.99	Pass
151	5755	-3.79	-3.40	-0.58	1.64	27.99	Pass
159	5795	-3.49	-3.50	-0.48	1.74	27.99	Pass

- Note: 1. Method b) Measure and sum spectral maxima across the outputs of KDB 662911 is using for calculating total power density.
 2. The directional gain is $5 \text{ dBi} + 10\log(2) = 8.01 \text{ dBi} > 6\text{dBi}$, so the power density limit shall be reduced to $30-(8.01-6) = 27.99 \text{ dBm}$.

802.11ax (HE80)

Chan.	Chan. Freq. (MHz)	PSD (dBm/300kHz)		Total PSD (dBm/300kHz)	Total PSD (dBm/500kHz)	PSD Limit (dBm/500kHz)	Pass / Fail
		Chain 0	Chain 1				
138 (U-NII-3 Band)	5690	-11.20	-10.89	-8.03	-5.81	27.99	Pass
155	5775	-7.84	-7.74	-4.78	-2.56	27.99	Pass

- Note: 1. Method b) Measure and sum spectral maxima across the outputs of KDB 662911 is using for calculating total power density.
 2. The directional gain is $5 \text{ dBi} + 10\log(2) = 8.01 \text{ dBi} > 6\text{dBi}$, so the power density limit shall be reduced to $30-(8.01-6) = 27.99 \text{ dBm}$.

802.11ax (RU26)

RU Configuration	Chan.	Chan. Freq. (MHz)	PSD (dBm/300kHz)		Total PSD (dBm/300kHz)	Total PSD (dBm/500kHz)	PSD Limit (dBm/500kHz)	Pass/Fail
			Chain 0	Chain 1				
26/8	144 (U-NII-3 Band)	5720	-3.06	-1.45	0.83	3.05	27.99	Pass
26/0	144 (U-NII-3 Band)	5720	-48.85	-47.45	-45.08	-42.86	27.99	Pass
26/0	149	5745	7.65	8.17	10.93	13.15	27.99	Pass
26/4	157	5785	8.88	9.33	12.12	14.34	27.99	Pass
26/8	165	5825	7.48	7.91	10.71	12.93	27.99	Pass

- Note: 1. Method b) Measure and sum spectral maxima across the outputs of KDB 662911 is using for calculating total power density.
 2. The directional gain is $5 \text{ dBi} + 10\log(2) = 8.01 \text{ dBi} > 6\text{dBi}$, so the power density limit shall be reduced to $30-(8.01-6) = 27.99 \text{ dBm}$.

802.11ax (RU52)

RU Configuration	Chan.	Chan. Freq. (MHz)	PSD (dBm/300kHz)		Total PSD (dBm/300kHz)	Total PSD (dBm/500kHz)	PSD Limit (dBm/500kHz)	Pass/Fail
			Chain 0	Chain 1				
52/40	144 (U-NII-3 Band)	5720	-4.75	-2.94	-0.74	1.48	27.99	Pass
52/37	144 (U-NII-3 Band)	5720	-43.86	-46.68	-42.03	-39.81	27.99	Pass
52/37	149	5745	6.98	7.51	10.26	12.48	27.99	Pass
52/39	157	5785	6.77	7.66	10.25	12.47	27.99	Pass
52/40	165	5825	7.18	7.16	10.18	12.40	27.99	Pass

- Note: 1. Method b) Measure and sum spectral maxima across the outputs of KDB 662911 is using for calculating total power density.
 2. The directional gain is $5 \text{ dBi} + 10\log(2) = 8.01 \text{ dBi} > 6\text{dBi}$, so the power density limit shall be reduced to $30-(8.01-6) = 27.99 \text{ dBm}$.

802.11ax (RU106)

RU Configuration	Chan.	Chan. Freq. (MHz)	PSD (dBm/300kHz)		Total PSD (dBm/300kHz)	Total PSD (dBm/500kHz)	PSD Limit (dBm/500kHz)	Pass/Fail
			Chain 0	Chain 1				
106/54	144 (U-NII-3 Band)	5720	-5.85	-5.21	-2.51	-0.29	27.99	Pass
106/53	144 (U-NII-3 Band)	5720	-39.35	-42.03	-37.48	-35.26	27.99	Pass
106/53	149	5745	4.48	5.58	8.08	10.30	27.99	Pass
106/54	157	5785	5.24	6.15	8.73	10.95	27.99	Pass
106/54	165	5825	5.64	6.11	8.89	11.11	27.99	Pass

- Note: 1. Method b) Measure and sum spectral maxima across the outputs of KDB 662911 is using for calculating total power density.
2. The directional gain is $5 \text{ dBi} + 10\log(2) = 8.01 \text{ dBi} > 6\text{dBi}$, so the power density limit shall be reduced to $30 - (8.01 - 6) = 27.99 \text{ dBm}$.

Spectrum Plot of Worst Value

802.11a_Chain 1 / CH157

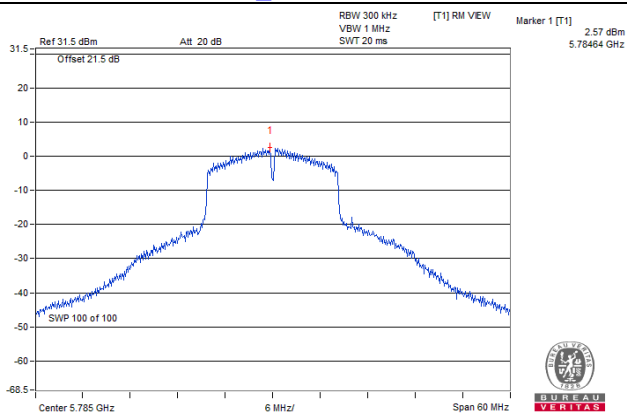

802.11ax (HE20)_Chain 1 / CH165

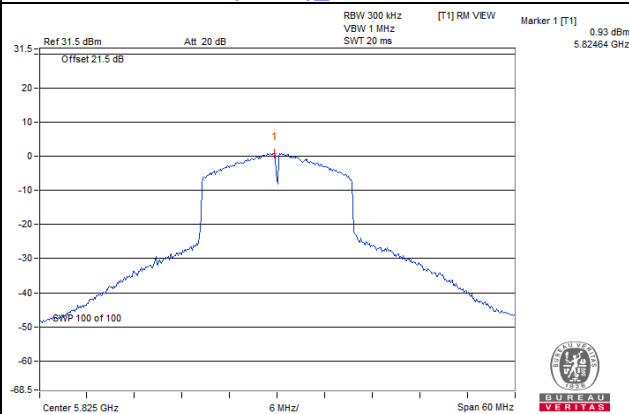

802.11ax (HE40)_Chain 1 / CH151

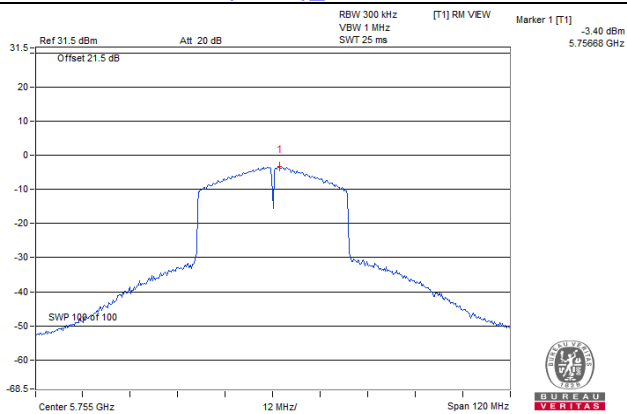

802.11ax (HE80)_Chain 1 / CH155

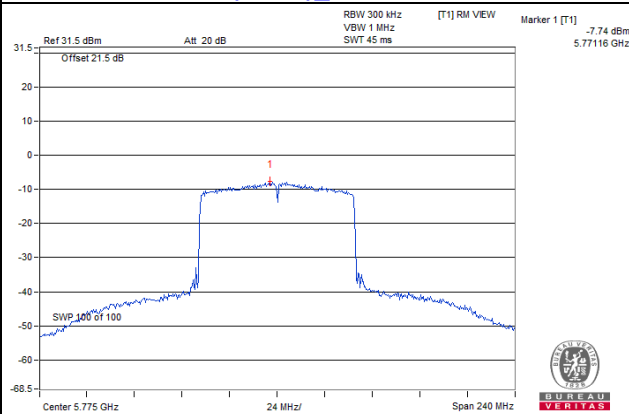

802.11ax (RU26)_Chain 1 / CH157

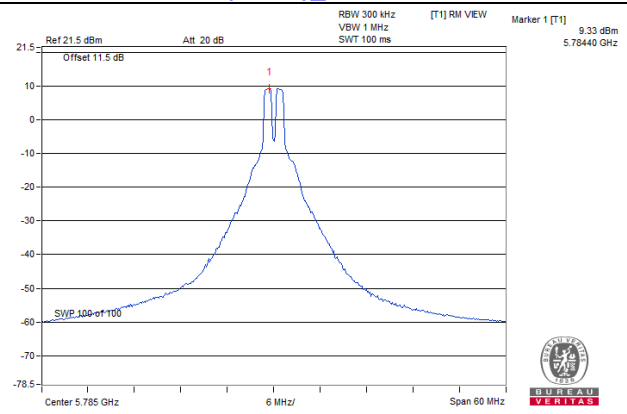

802.11ax (RU52)_Chain 1 / CH157

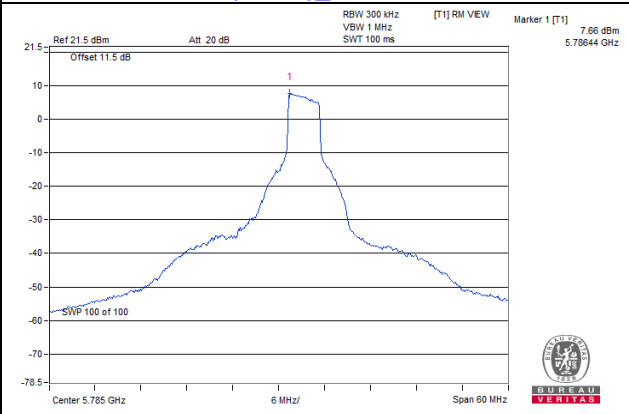

802.11ax (RU106)_Chain 1 / CH157

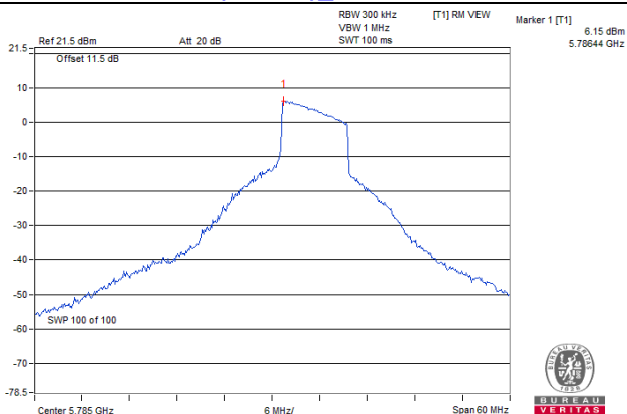

4.5.8 Test Results (Mode 2)

For U-NII-1, U-NII-2A, U-NII-2C band:

802.11a

Chan.	Chan. Freq. (MHz)	PSD (dBm/MHz)	Max. PSD Limit (dBm/MHz)	Pass / Fail
36	5180	10.39	11.00	Pass
40	5200	10.78	11.00	Pass
48	5240	10.94	11.00	Pass
52	5260	10.92	11.00	Pass
60	5300	10.96	11.00	Pass
64	5320	10.93	11.00	Pass
100	5500	9.06	11.00	Pass
116	5580	10.94	11.00	Pass
140	5700	7.81	11.00	Pass
144 (U-NII-2C Band)	5720	10.76	11.00	Pass

802.11ax (HE20)

Chan.	Chan. Freq. (MHz)	PSD (dBm/MHz)	Max. PSD Limit (dBm/MHz)	Pass / Fail
36	5180	9.96	11.00	Pass
40	5200	10.33	11.00	Pass
48	5240	10.63	11.00	Pass
52	5260	10.85	11.00	Pass
60	5300	10.69	11.00	Pass
64	5320	9.28	11.00	Pass
100	5500	8.31	11.00	Pass
116	5580	10.60	11.00	Pass
140	5700	7.14	11.00	Pass
144 (U-NII-2C Band)	5720	10.58	11.00	Pass

802.11ax (HE40)

Chan.	Chan. Freq. (MHz)	PSD (dBm/MHz)	Max. PSD Limit (dBm/MHz)	Pass / Fail
38	5190	3.03	11.00	Pass
46	5230	6.60	11.00	Pass
54	5270	6.77	11.00	Pass
62	5310	3.75	11.00	Pass
102	5510	2.56	11.00	Pass
110	5550	6.99	11.00	Pass
134	5670	4.78	11.00	Pass
142 (U-NII-2C Band)	5710	6.70	11.00	Pass

802.11ax (HE80)

Chan.	Chan. Freq. (MHz)	PSD (dBm/MHz)	Max. PSD Limit (dBm/MHz)	Pass / Fail
42	5210	-1.22	11.00	Pass
58	5290	-0.51	11.00	Pass
106	5530	-1.85	11.00	Pass
122	5610	2.24	11.00	Pass
138 (U-NII-2C Band)	5690	2.10	11.00	Pass

802.11ax (RU26)

RU Configuration	Chan.	Chan. Freq. (MHz)	PSD (dBm/MHz)	Max. PSD Limit (dBm/MHz)	Pass / Fail
26/0	36	5180	10.94	11.00	Pass
26/4	40	5200	10.85	11.00	Pass
26/8	48	5240	10.70	11.00	Pass
26/0	52	5260	10.88	11.00	Pass
26/4	60	5300	10.83	11.00	Pass
26/8	64	5320	10.86	11.00	Pass
26/0	100	5500	10.85	11.00	Pass
26/4	116	5580	10.86	11.00	Pass
26/8	140	5700	10.85	11.00	Pass
26/8	144 (U-NII-2C Band)	5720	-15.33	11.00	Pass
26/0	144 (U-NII-2C Band)	5720	10.47	11.00	Pass

802.11ax (RU52)

RU Configuration	Chan.	Chan. Freq. (MHz)	PSD (dBm/MHz)	Max. PSD Limit (dBm/MHz)	Pass / Fail
52/37	36	5180	10.92	11.00	Pass
52/39	40	5200	10.81	11.00	Pass
52/40	48	5240	10.70	11.00	Pass
52/37	52	5260	10.90	11.00	Pass
52/39	60	5300	10.92	11.00	Pass
52/40	64	5320	10.73	11.00	Pass
52/37	100	5500	10.75	11.00	Pass
52/39	116	5580	10.76	11.00	Pass
52/40	140	5700	10.86	11.00	Pass
52/40	144 (U-NII-2C Band)	5720	1.82	11.00	Pass
52/37	144 (U-NII-2C Band)	5720	10.75	11.00	Pass

802.11ax (RU106)

RU Configuration	Chan.	Chan. Freq. (MHz)	PSD (dBm/MHz)	Max. PSD Limit (dBm/MHz)	Pass / Fail
106/53	36	5180	10.85	11.00	Pass
106/53	40	5200	10.74	11.00	Pass
106/54	48	5240	10.70	11.00	Pass
106/53	52	5260	10.84	11.00	Pass
106/54	60	5300	10.89	11.00	Pass
106/54	64	5320	10.85	11.00	Pass
106/53	100	5500	10.73	11.00	Pass
106/53	116	5580	10.86	11.00	Pass
106/54	140	5700	10.96	11.00	Pass
106/54	144 (U-NII-2C Band)	5720	10.74	11.00	Pass
106/54	144 (U-NII-2C Band)	5720	10.79	11.00	Pass

Spectrum Plot of Worst Value

802.11a / CH60

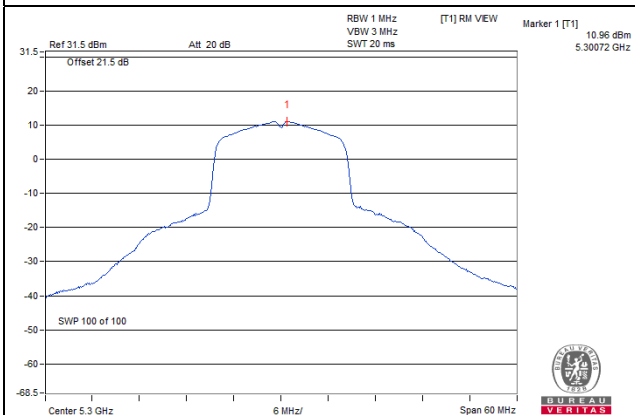

802.11ax (HE20) / CH52

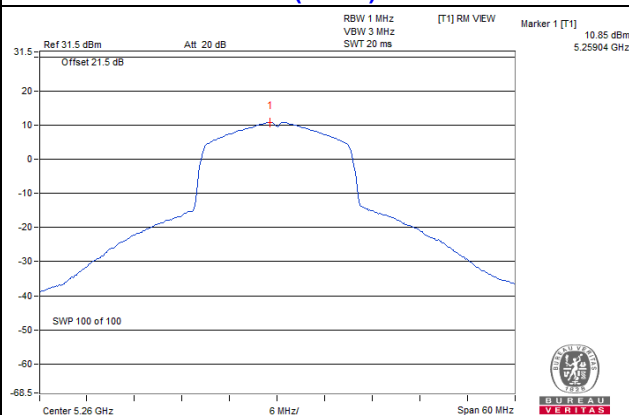

802.11ax (HE40) / CH110

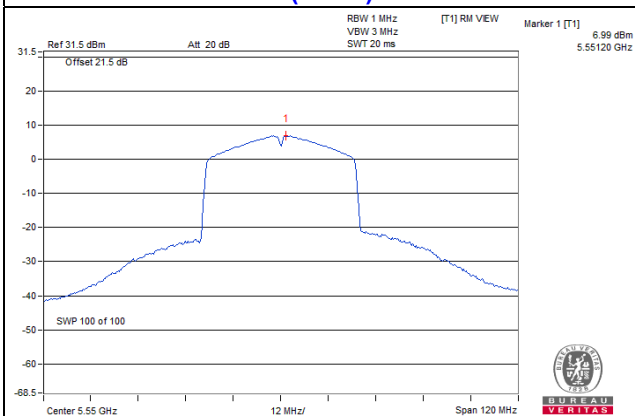

802.11ax (HE80) / CH122

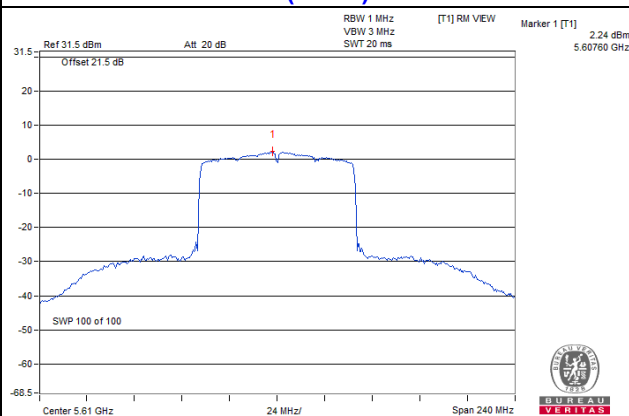

802.11ax (RU26) / CH36

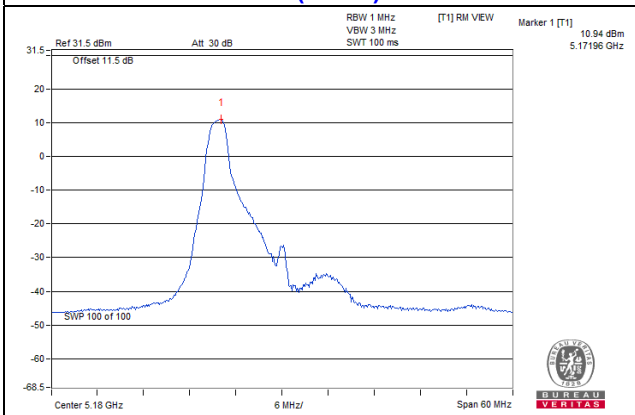

802.11ax (RU52) / CH36

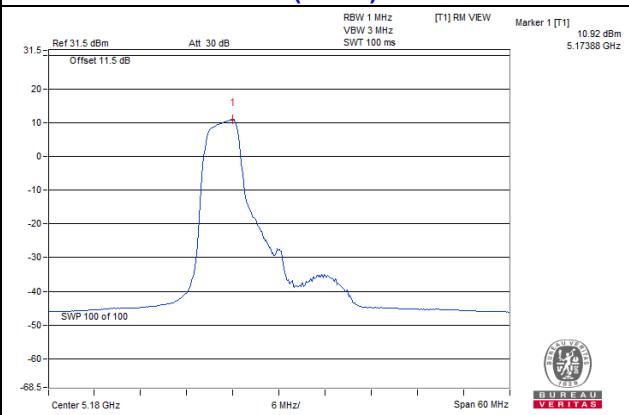

802.11ax (RU106) / CH140

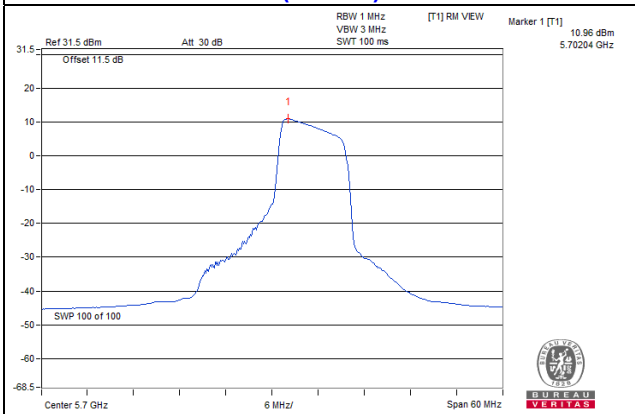

For U-NII-3 band:

802.11a

Chan.	Chan. Freq. (MHz)	PSD (dBm/300kHz)	Total PSD (dBm/500kHz)	PSD Limit (dBm/500kHz)	Pass / Fail
144 (U-NII-3 Band)	5720	-1.01	1.21	30.00	Pass
149	5745	2.71	4.93	30.00	Pass
157	5785	2.61	4.83	30.00	Pass
165	5825	2.47	4.69	30.00	Pass

802.11ax (HE20)

Chan.	Chan. Freq. (MHz)	PSD (dBm/300kHz)	Total PSD (dBm/500kHz)	PSD Limit (dBm/500kHz)	Pass / Fail
144 (U-NII-3 Band)	5720	-1.64	0.58	30.00	Pass
149	5745	1.75	3.97	30.00	Pass
157	5785	1.54	3.76	30.00	Pass
165	5825	1.62	3.84	30.00	Pass

802.11ax (HE40)

Chan.	Chan. Freq. (MHz)	PSD (dBm/300kHz)	Total PSD (dBm/500kHz)	PSD Limit (dBm/500kHz)	Pass / Fail
142 (U-NII-3 Band)	5710	-7.41	-5.19	30.00	Pass
151	5755	-2.66	-0.44	30.00	Pass
159	5795	-2.29	-0.07	30.00	Pass

802.11ax (HE80)

Chan.	Chan. Freq. (MHz)	PSD (dBm/300kHz)	Total PSD (dBm/500kHz)	PSD Limit (dBm/500kHz)	Pass / Fail
138 (U-NII-3 Band)	5690	-9.64	-7.42	30.00	Pass
155	5775	-6.88	-4.66	30.00	Pass

802.11ax (RU26)

RU Configuration	Chan.	Chan. Freq. (MHz)	PSD (dBm/300kHz)	Total PSD (dBm/500kHz)	PSD Limit (dBm/500kHz)	Pass / Fail
26/8	144 (U-NII-3 Band)	5720	2.15	4.37	30.00	Pass
26/0	144 (U-NII-3 Band)	5720	-44.81	-42.59	30.00	Pass
26/0	149	5745	9.50	11.72	30.00	Pass
26/4	157	5785	9.25	11.47	30.00	Pass
26/8	165	5825	9.40	11.62	30.00	Pass

802.11ax (RU52)

RU Configuration	Chan.	Chan. Freq. (MHz)	PSD (dBm/300kHz)	Total PSD (dBm/500kHz)	PSD Limit (dBm/500kHz)	Pass / Fail
52/40	144 (U-NII-3 Band)	5720	2.14	4.36	30.00	Pass
52/37	144 (U-NII-3 Band)	5720	-42.62	-40.40	30.00	Pass
52/37	149	5745	7.10	9.32	30.00	Pass
52/39	157	5785	7.30	9.52	30.00	Pass
52/40	165	5825	7.75	9.97	30.00	Pass

802.11ax (RU106)

RU Configuration	Chan.	Chan. Freq. (MHz)	PSD (dBm/300kHz)	Total PSD (dBm/500kHz)	PSD Limit (dBm/500kHz)	Pass / Fail
106/54	144 (U-NII-3 Band)	5720	-0.23	1.99	30.00	Pass
106/53	144 (U-NII-3 Band)	5720	-34.50	-32.28	30.00	Pass
106/53	149	5745	5.01	7.23	30.00	Pass
106/54	157	5785	5.55	7.77	30.00	Pass
106/54	165	5825	5.73	7.95	30.00	Pass

Spectrum Plot of Worst Value

802.11a / CH149

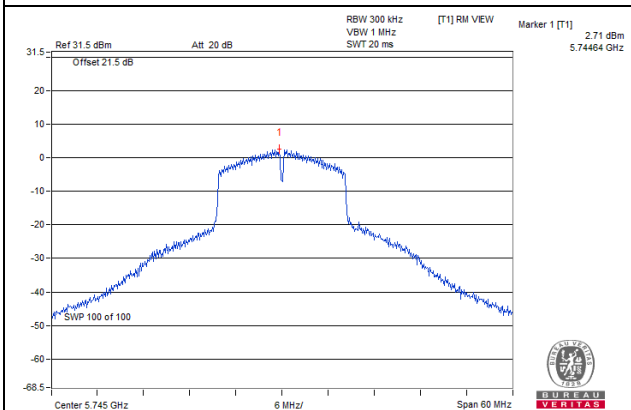

802.11ax (HE20) / CH149

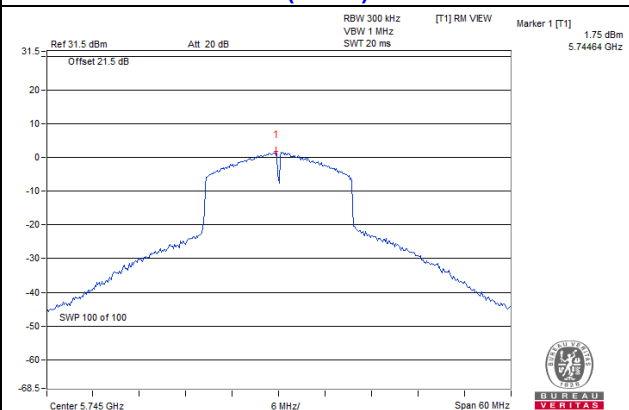

802.11ax (HE40) / CH159

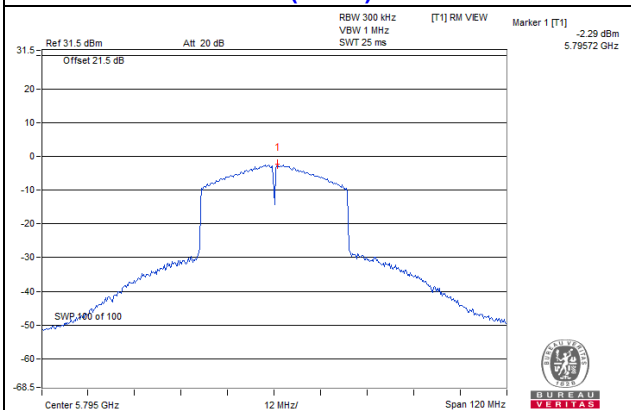

802.11ax (HE80) / CH155

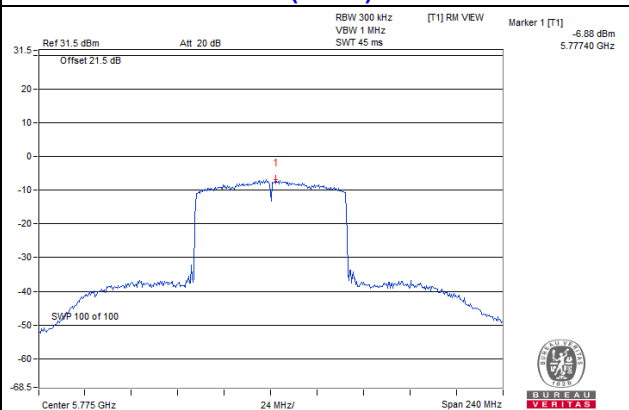

802.11ax (RU26) / CH149

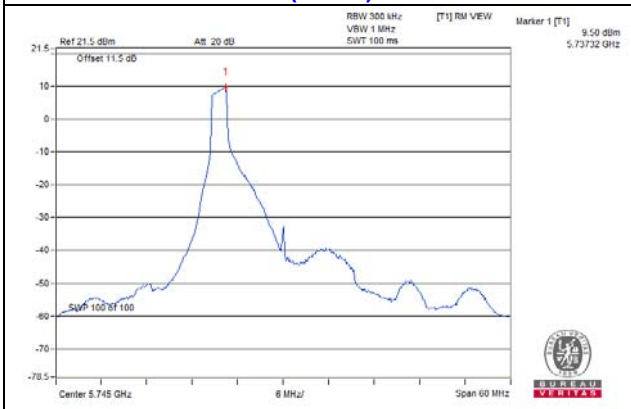

802.11ax (RU52) / CH165

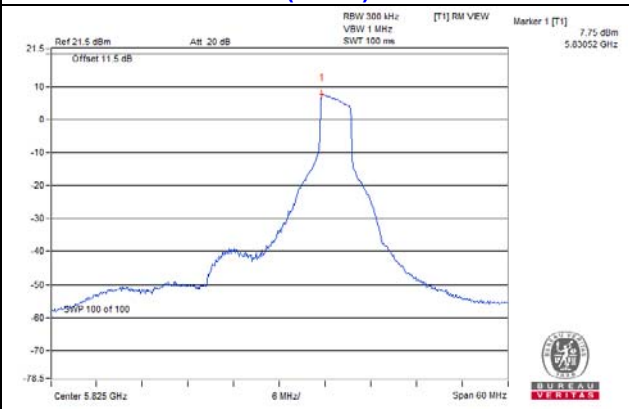

802.11ax (RU106) / CH165

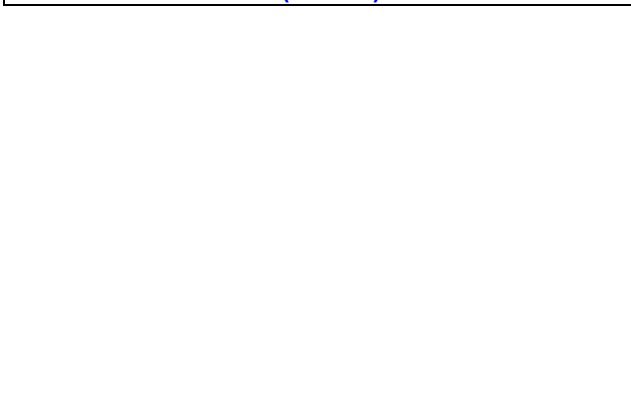

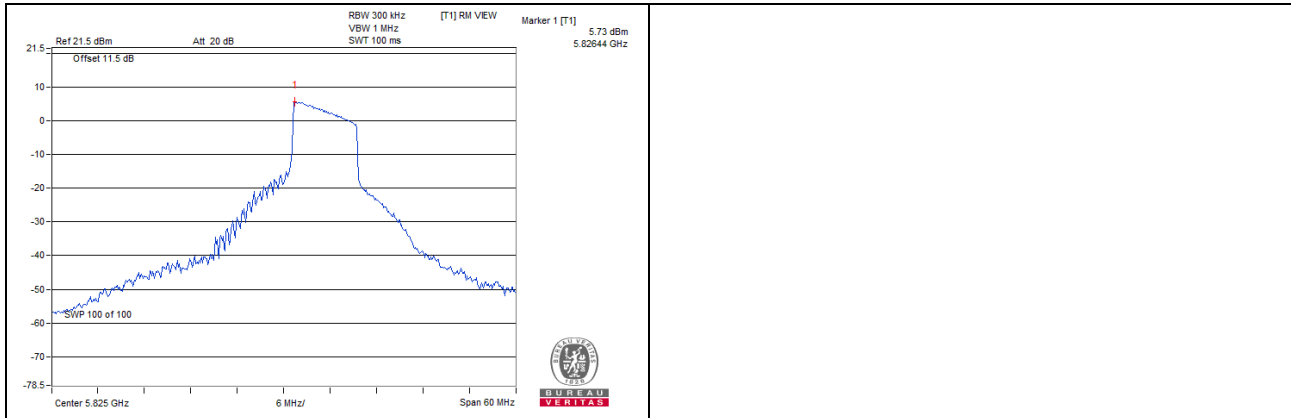

4.6 Frequency Stability Measurement

4.6.1 Limits of Frequency Stability Measurement

The frequency of the carrier signal shall be maintained within band of operation

4.6.2 Test Setup

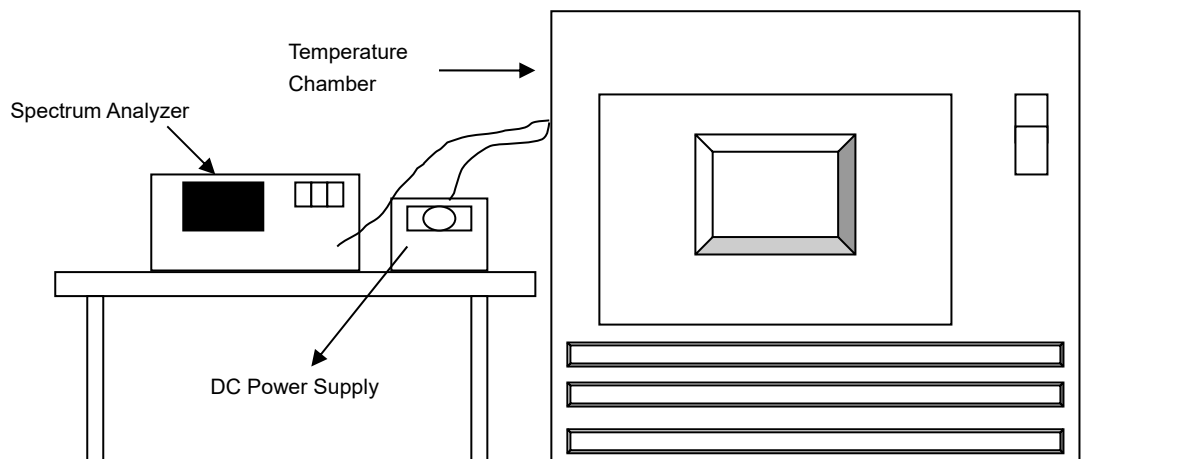

4.6.3 Test Instruments

Refer to section 4.1.2 to get information of above instrument.

4.6.4 Test Procedure

- The EUT was placed inside the environmental test chamber and powered by nominal DC voltage.
- Turn the EUT on and couple its output to a spectrum analyzer.
- Turn the EUT off and set the chamber to the highest temperature specified.
- Allow sufficient time (approximately 30 min) for the temperature of the chamber to stabilize, turn the EUT on and measure the operating frequency after 2, 5, and 10 Minutes.
- Repeat step (d) with the temperature chamber set to the next desired temperature until measurements down to the lowest specified temperature have been completed.

f. The test chamber was allowed to stabilize at +20 degree C for a minimum of 30 Minutes. The supply voltage was then adjusted on the EUT from 85% to 115% and the frequency record.

4.6.5 Deviation from Test Standard

No deviation.

4.6.6 EUT Operating Condition

Set the EUT transmit at un-modulation mode to test frequency stability.

4.6.7 Test Results

Frequency Stability Versus Temp.									
Operating Frequency: 5180 MHz									
TEMP. (°C)	Power Supply (Vdc)	0 Minute		2 Minutes		5 Minutes		10 Minutes	
		Measured Frequency (MHz)	Pass/Fail	Measured Frequency (MHz)	Pass/Fail	Measured Frequency (MHz)	Pass/Fail	Measured Frequency (MHz)	Pass/Fail
70	3.3	5179.9982	Pass	5179.9975	Pass	5179.9975	Pass	5179.9968	Pass
60	3.3	5179.9741	Pass	5179.975	Pass	5179.9726	Pass	5179.9736	Pass
50	3.3	5179.9945	Pass	5179.9971	Pass	5179.9946	Pass	5179.9977	Pass
40	3.3	5180.0236	Pass	5180.0248	Pass	5180.0222	Pass	5180.0239	Pass
30	3.3	5180.0098	Pass	5180.0095	Pass	5180.0112	Pass	5180.0075	Pass
20	3.3	5180.004	Pass	5180.0008	Pass	5180.0025	Pass	5180.0004	Pass
10	3.3	5180.0198	Pass	5180.0186	Pass	5180.0195	Pass	5180.0212	Pass
0	3.3	5180.0022	Pass	5180.0046	Pass	5180.0018	Pass	5180.0041	Pass
-10	3.3	5179.9978	Pass	5179.9984	Pass	5179.9973	Pass	5179.9971	Pass
-20	3.3	5179.9772	Pass	5179.978	Pass	5179.9774	Pass	5179.9788	Pass

Frequency Stability Versus Voltage									
Operating Frequency: 5180 MHz									
TEMP. (°C)	Power Supply (Vdc)	0 Minute		2 Minutes		5 Minutes		10 Minutes	
		Measured Frequency (MHz)	Pass/Fail	Measured Frequency (MHz)	Pass/Fail	Measured Frequency (MHz)	Pass/Fail	Measured Frequency (MHz)	Pass/Fail
20	3.795	5180.005	Pass	5180.0007	Pass	5180.0026	Pass	5180.0006	Pass
	3.3	5180.004	Pass	5180.0008	Pass	5180.0025	Pass	5180.0004	Pass
	2.805	5180.0033	Pass	5180.0014	Pass	5180.0025	Pass	5180.0004	Pass

4.7 6dB Bandwidth Measurement

4.7.1 Limits of 6dB Bandwidth Measurement

The minimum of 6dB Bandwidth Measurement is 0.5MHz.

4.7.2 Test Setup

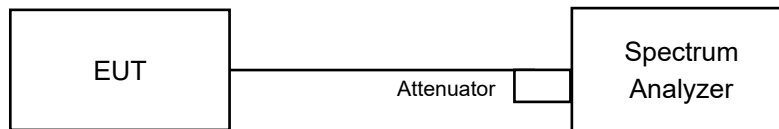

4.7.3 Test Instruments

Refer to section 4.1.2 to get information of above instrument.

4.7.4 Test Procedure

MEASUREMENT PROCEDURE REF

- Set resolution bandwidth (RBW) = 100kHz
- Set the video bandwidth (VBW) $\geq 3 \times$ RBW, Detector = Peak.
- Trace mode = max hold.
- Sweep = auto couple.
- Measure the maximum width of the emission that is constrained by the frequencies associated with the two amplitude points (upper and lower) that are attenuated by 6 dB relative to the maximum level measured in the fundamental emission

4.7.5 Deviation from Test Standard

No deviation.

4.7.6 EUT Operating Condition

The software provided by client to enable the EUT under transmission condition continuously at lowest, middle and highest channel frequencies individually.

4.7.7 Test Results (Mode 1)

CDD Mode
802.11a

Channel	Frequency (MHz)	6dB Bandwidth (MHz)		Pass / Fail
		Chain 0	Chain 1	
144 (U-NII-3 Band)	5720	2.51	2.52	Pass
149	5745	15.12	15.11	Pass
157	5785	15.12	15.12	Pass
165	5825	15.09	15.13	Pass

802.11ax (HE20)

Channel	Frequency (MHz)	6dB Bandwidth (MHz)		Pass / Fail
		Chain 0	Chain 1	
144 (U-NII-3 Band)	5720	2.52	2.51	Pass
149	5745	15.11	15.13	Pass
157	5785	15.12	15.12	Pass
165	5825	15.1	15.13	Pass

802.11ax (HE40)

Channel	Frequency (MHz)	6dB Bandwidth (MHz)		Pass / Fail
		Chain 0	Chain 1	
142 (U-NII-3 Band)	5710	1.23	1.21	Pass
151	5755	31.36	31.44	Pass
159	5795	31.41	32.64	Pass

802.11ax (HE80)

Channel	Frequency (MHz)	6dB Bandwidth (MHz)		Pass / Fail
		Chain 0	Chain 1	
138 (U-NII-3 Band)	5690	2.76	2.7	Pass
155	5775	75.39	75.4	Pass

802.11ax (RU26)

RU Configuration	Channel	Frequency (MHz)	6dB Bandwidth (MHz)		Pass / Fail
			Chain 0	Chain 1	
26/8	144 (U-NII-3 Band)	5720	4.43	4.42	Pass
26/0	149	5745	14.5	15.73	Pass
26/4	157	5785	2.68	2.72	Pass
26/8	165	5825	15.81	14.51	Pass

802.11ax (RU52)

RU Configuration	Channel	Frequency (MHz)	6dB Bandwidth (MHz)		Pass / Fail
			Chain 0	Chain 1	
52/40	144 (U-NII-3 Band)	5720	4.41	4.41	Pass
52/37	149	5745	17.01	16.98	Pass
52/39	157	5785	10.42	10.43	Pass
52/40	165	5825	15.78	16.97	Pass

802.11ax (RU106)

RU Configuration	Channel	Frequency (MHz)	6dB Bandwidth (MHz)		Pass / Fail
			Chain 0	Chain 1	
106/54	144 (U-NII-3 Band)	5720	3.43	3.47	Pass
106/53	149	5745	16.91	15.78	Pass
106/54	157	5785	16.05	17.01	Pass
106/54	165	5825	16.96	17.01	Pass

Spectrum Plot of Worst Value

802.11a_Chain 0 / CH144 (U-NII-3 Band)

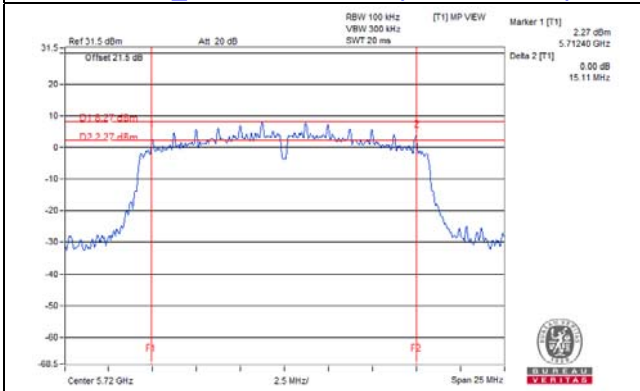

802.11ax (HE20)_Chain 1 / CH144 (U-NII-3 Band)

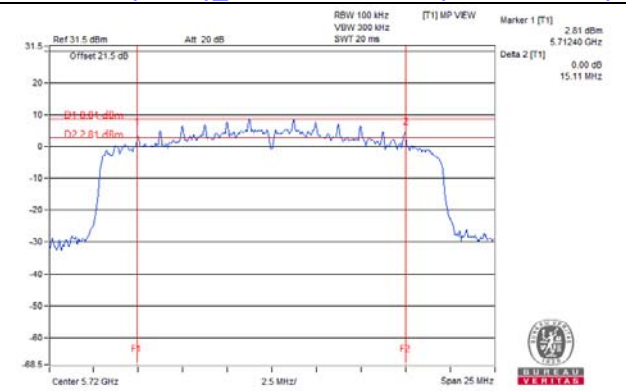

802.11ax (HE40)_Chain 1 / CH142 (U-NII-3 Band)

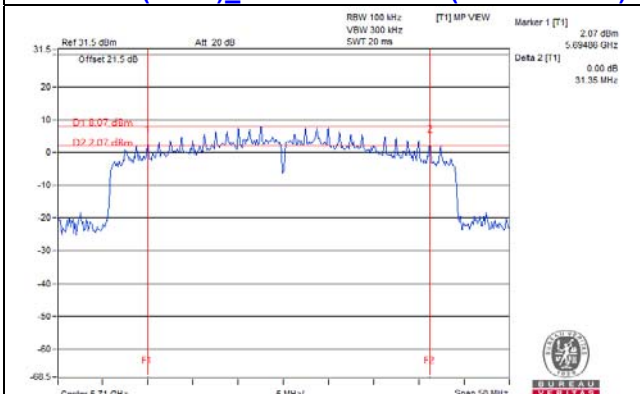

802.11ax (HE80)_Chain 1 / CH138 (U-NII-3 Band)

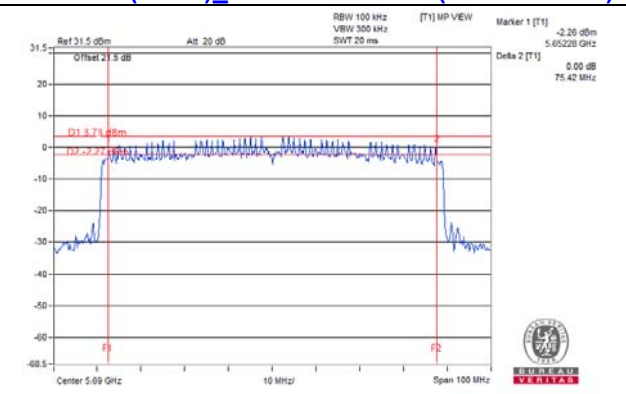

802.11ax (RU26)_Chain 0 / CH157

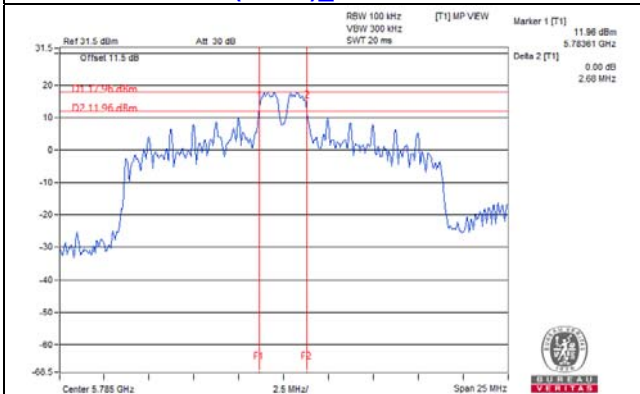

802.11ax (RU52)_Chain 0 / CH144 (U-NII-3 Band)

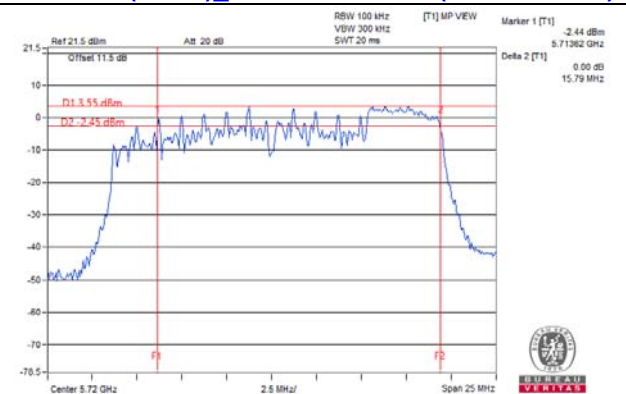

802.11ax (RU106)_Chain 0 / CH144 (U-NII-3 Band)

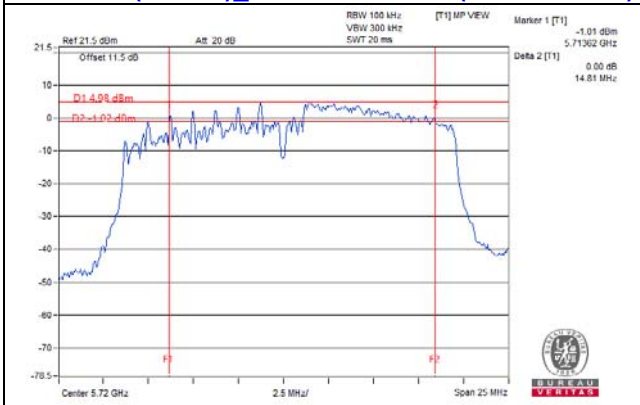

Note: The 6dB bandwidth above 5725MHz = Marker 1 + Delta 2 - 5725MHz

4.7.8 Test Results (Mode 2)

802.11a

Channel	Frequency (MHz)	6dB Bandwidth (MHz)	Pass / Fail
144 (U-NII-3 Band)	5720	2.52	Pass
149	5745	15.12	Pass
157	5785	15.13	Pass
165	5825	15.13	Pass

802.11ax (HE20)

Channel	Frequency (MHz)	6dB Bandwidth (MHz)	Pass / Fail
144 (U-NII-3 Band)	5720	2.52	Pass
149	5745	15.13	Pass
157	5785	15.13	Pass
165	5825	15.13	Pass

802.11ax (HE40)

Channel	Frequency (MHz)	6dB Bandwidth (MHz)	Pass / Fail
142 (U-NII-3 Band)	5710	0.53	Pass
151	5755	32.59	Pass
159	5795	32.66	Pass

802.11ax (HE80)

Channel	Frequency (MHz)	6dB Bandwidth (MHz)	Pass / Fail
138 (U-NII-3 Band)	5690	2.76	Pass
155	5775	76.55	Pass

802.11ax (RU26)

RU Configuration	Channel	Frequency (MHz)	6dB Bandwidth (MHz)	Pass / Fail
26/8	144 (U-NII-3 Band)	5720	4.45	Pass
26/0	149	5745	14.53	Pass
26/4	157	5785	2.67	Pass
26/8	165	5825	15.81	Pass

802.11ax (RU52)

RU Configuration	Channel	Frequency (MHz)	6dB Bandwidth (MHz)	Pass / Fail
52/40	144 (U-NII-3 Band)	5720	4.42	Pass
52/37	149	5745	17.01	Pass
52/39	157	5785	10.42	Pass
52/40	165	5825	15.78	Pass

802.11ax (RU106)

RU Configuration	Channel	Frequency (MHz)	6dB Bandwidth (MHz)	Pass / Fail
106/54	144 (U-NII-3 Band)	5720	3.44	Pass
106/53	149	5745	16.91	Pass
106/54	157	5785	16.06	Pass
106/54	165	5825	16.06	Pass

Spectrum Plot of Worst Value

802.11a / CH144 (U-NII-3 Band)

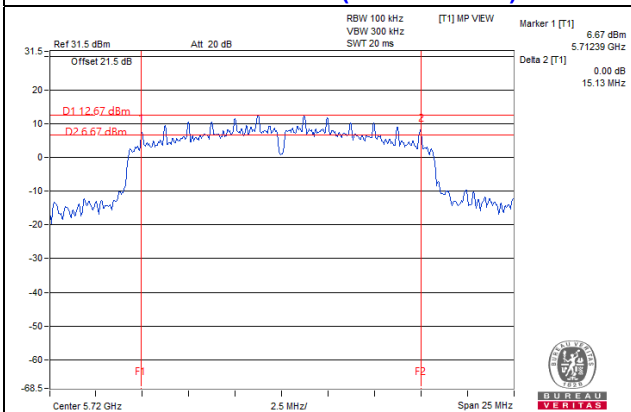

802.11ax (HE20) / CH144 (U-NII-3 Band)

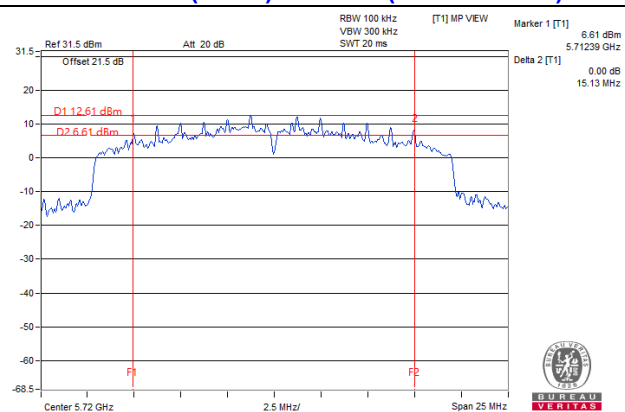

802.11ax (HE40) / CH142 (U-NII-3 Band)

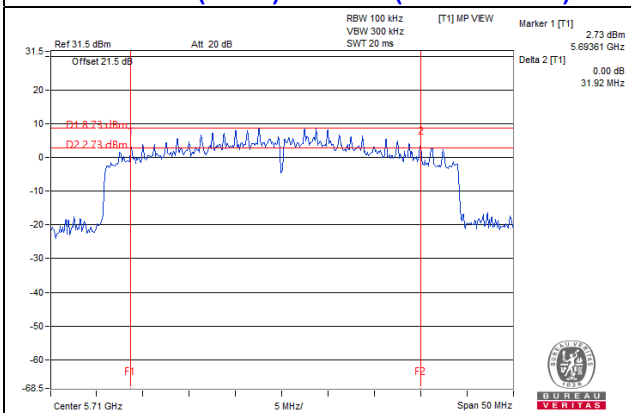

802.11ax (HE80) / CH138 (U-NII-3 Band)

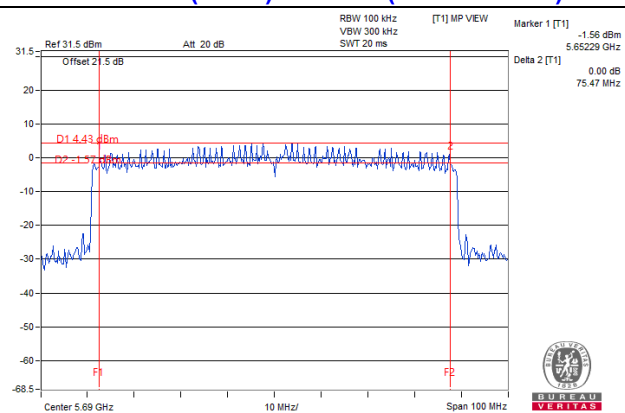

802.11ax (RU26) / CH144 (U-NII-3 Band)

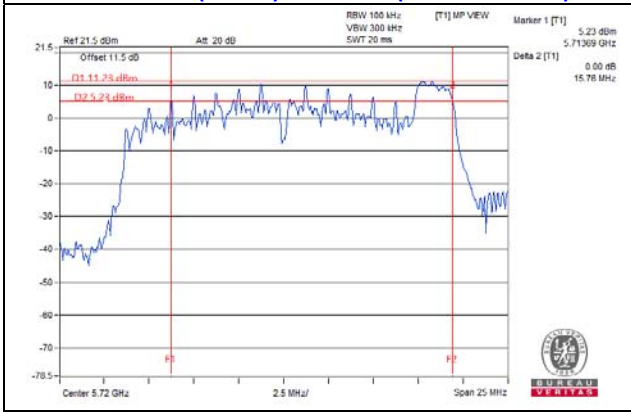

802.11ax (RU52) / CH144 (U-NII-3 Band)

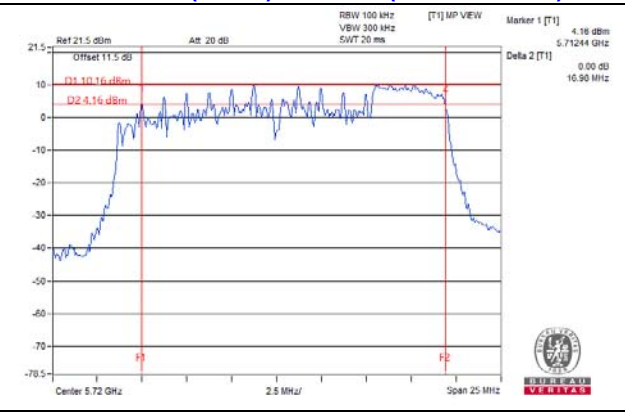

802.11ax (RU106) / CH144 (U-NII-3 Band)

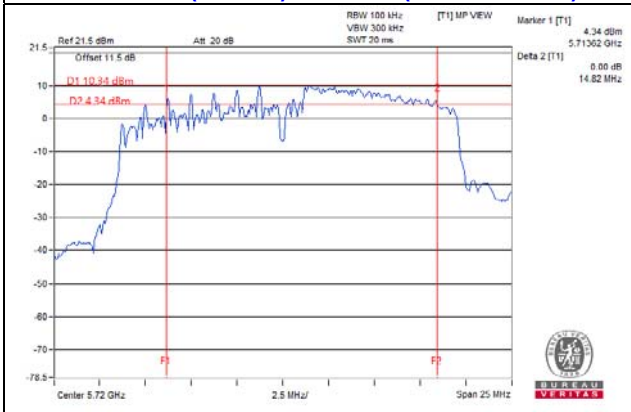

Note: The 6dB bandwidth above 5725MHz = Marker 1 + Delta 2 - 5725MHz

5 Pictures of Test Arrangements

Please refer to the attached file (Test Setup Photo).

Annex A - Radiated Out of Band Emission (OOBE) Measurement (For U-NII-3 band)

Annex A.1 - Test Results (Mode 1)

Dipole Antenna

802.11a CH 149 : 5745 MHz

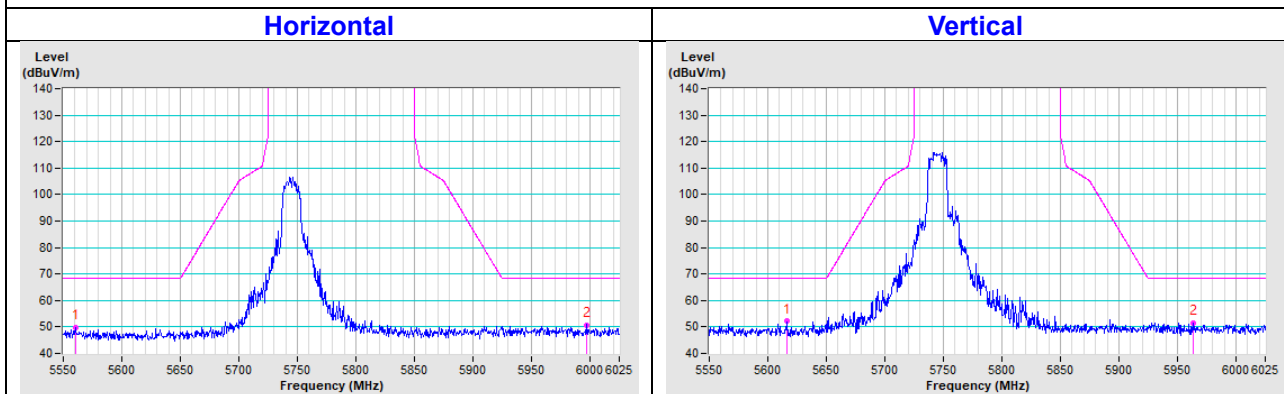

802.11a CH 157 : 5785 MHz

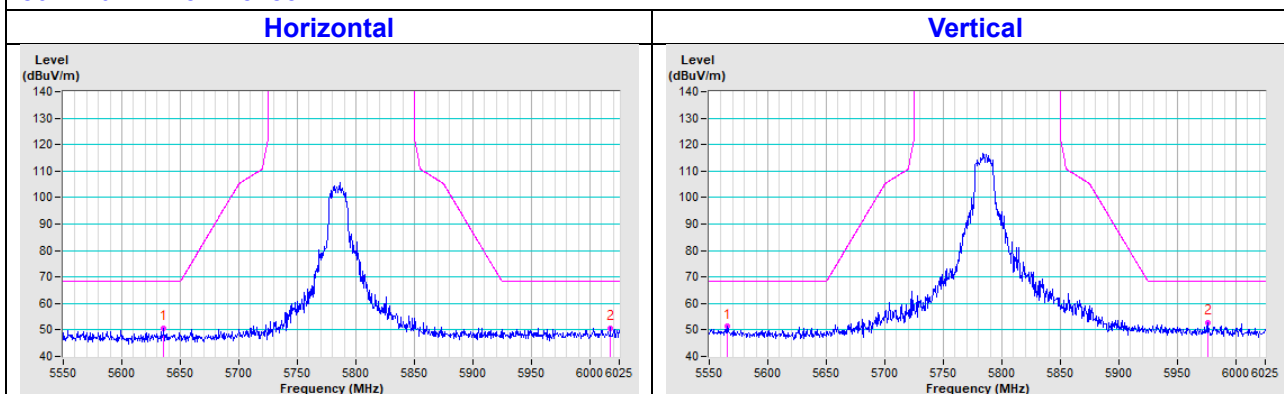

802.11a CH 165 : 5825 MHz

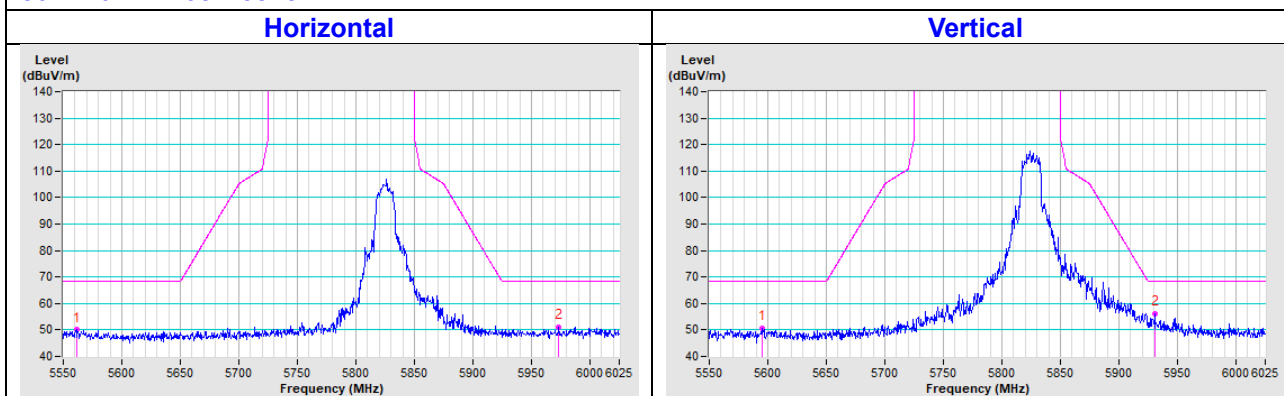

802.11ax (HE20) CH 149 : 5745 MHz

Horizontal

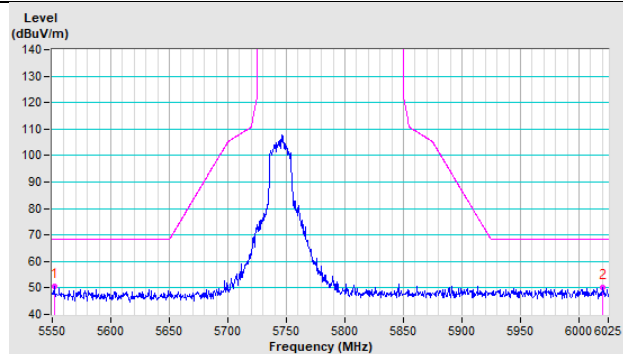

Vertical

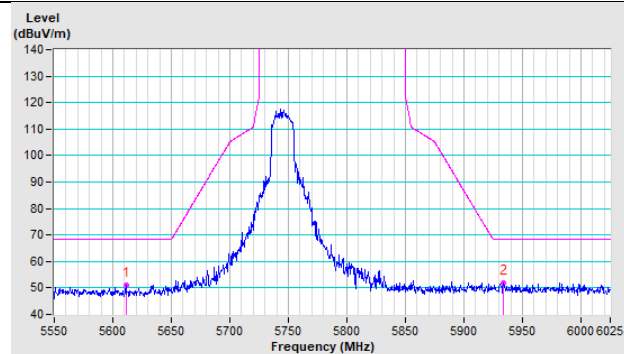

802.11ax (HE20) CH 157 : 5785 MHz

Horizontal

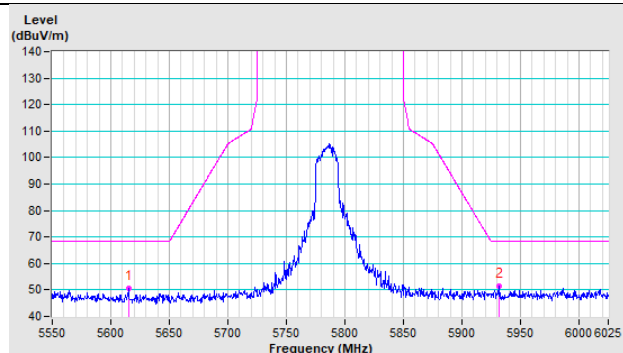

Vertical

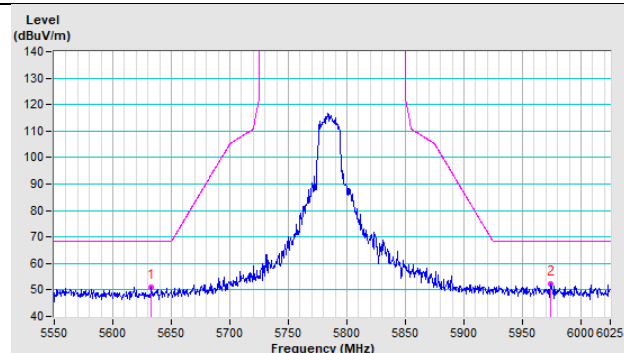

802.11ax (HE20) CH 165 : 5825 MHz

Horizontal

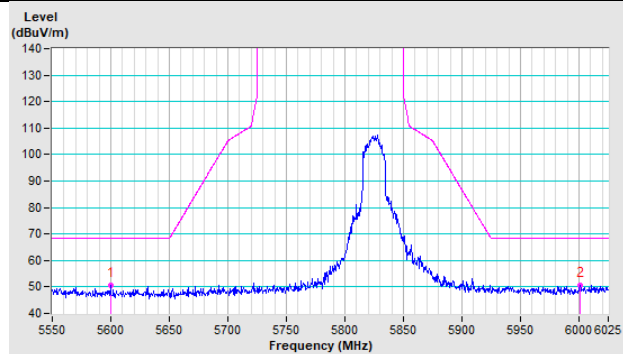

Vertical

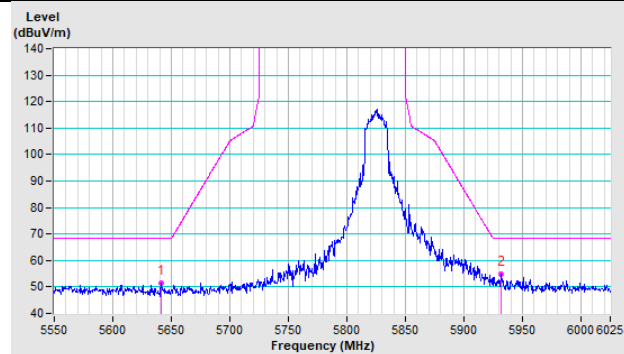

802.11ax (HE40) CH 151 : 5755 MHz

Horizontal

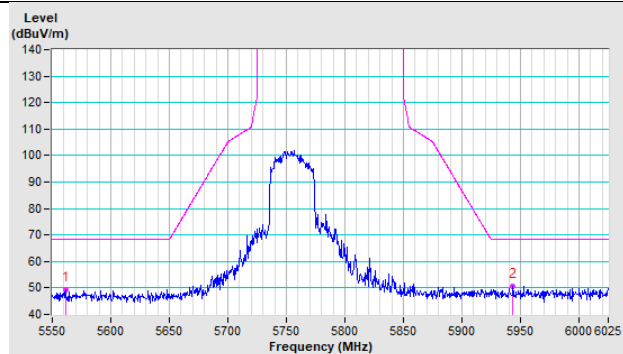

Vertical

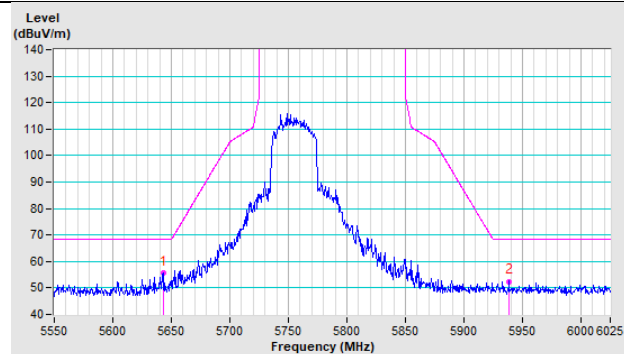

802.11ax (HE40) CH 159 : 5795 MHz

Horizontal

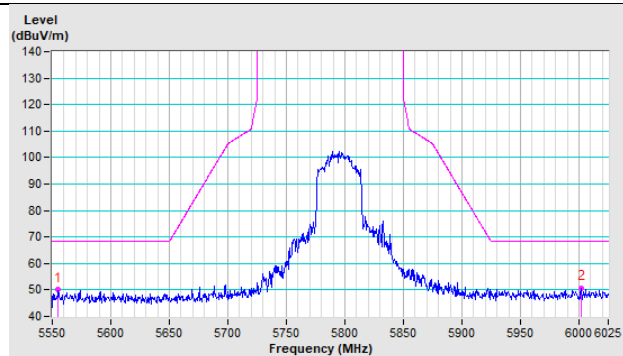

Vertical

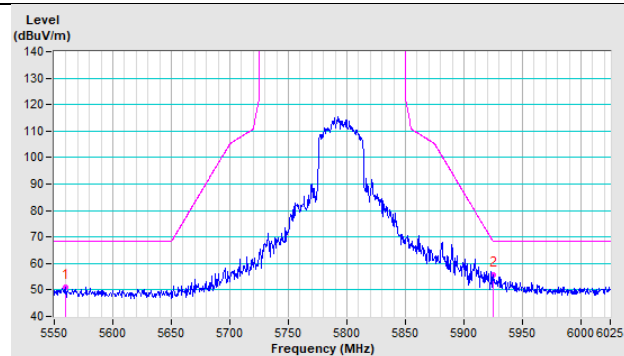

802.11ax (HE80) CH 155 : 5775 MHz

Horizontal

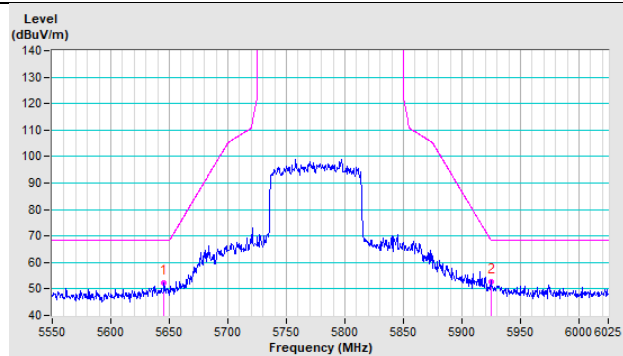

Vertical

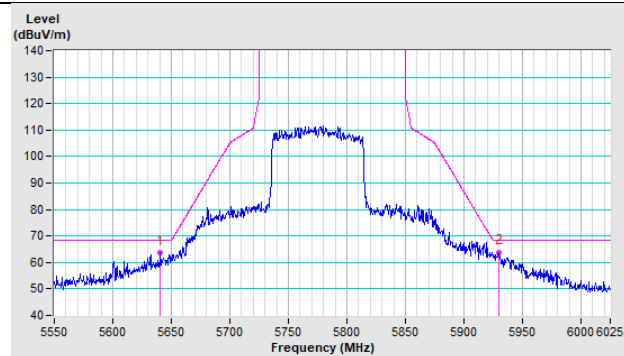

20MHz Preamble 802.11ax (RU26) CH 149 : 5745 MHz

Horizontal

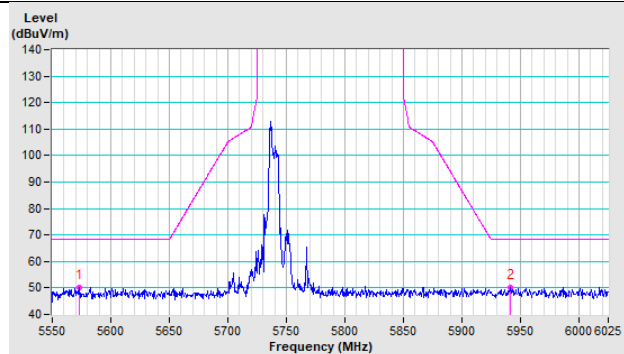

Vertical

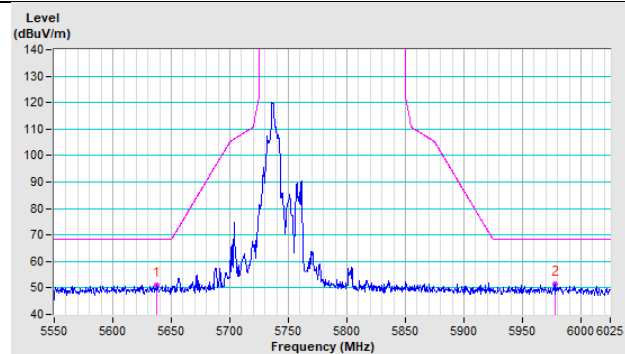

20MHz Preamble 802.11ax (RU26) CH 157 : 5785 MHz

Horizontal

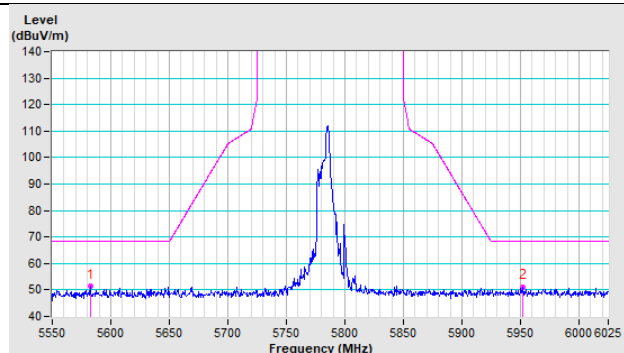

Vertical

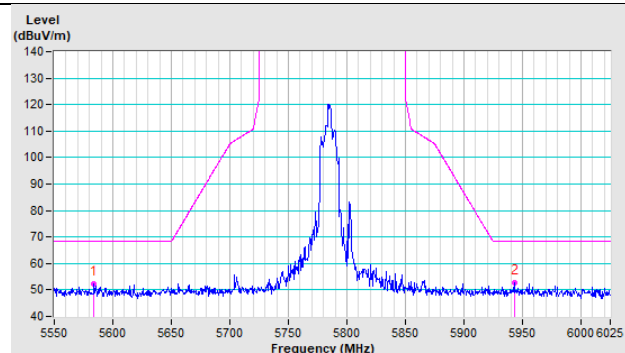

20MHz Preamble 802.11ax (RU26) CH 165 : 5825 MHz

Horizontal

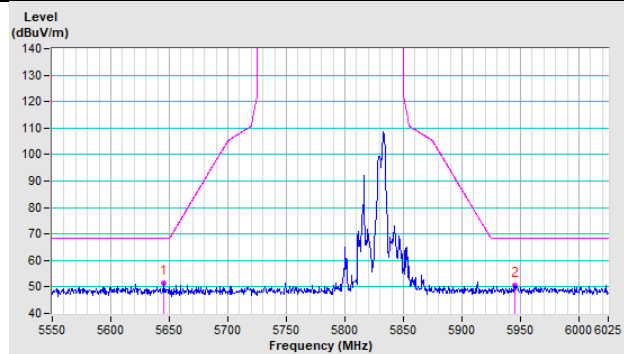

Vertical

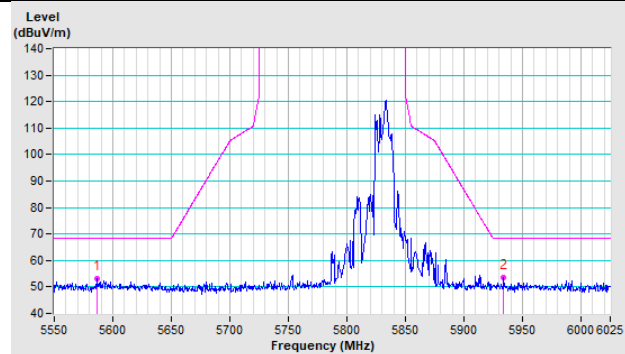

20MHz Preamble 802.11ax (RU52) CH 149 : 5745 MHz

Horizontal

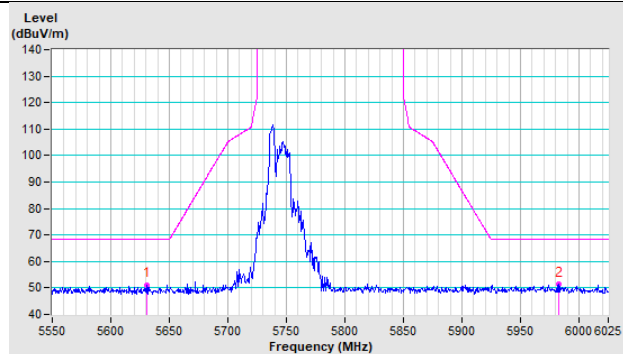

Vertical

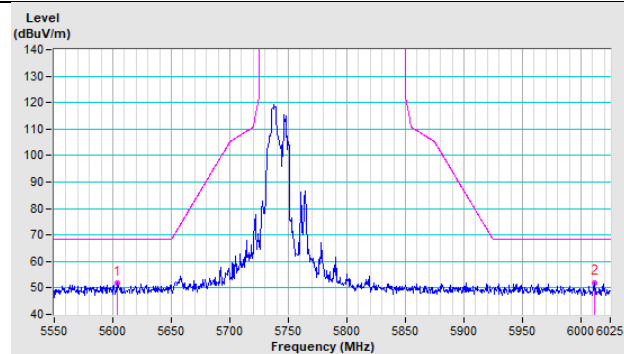

20MHz Preamble 802.11ax (RU52) CH 157 : 5785 MHz

Horizontal

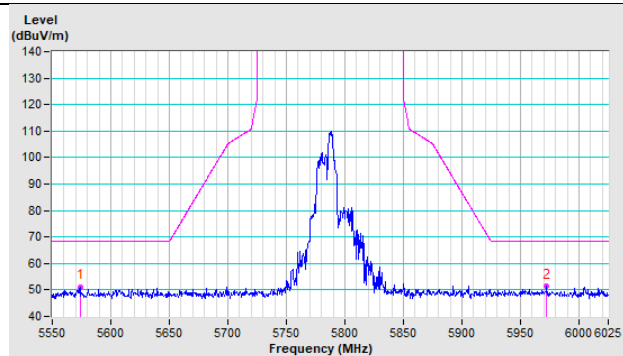

Vertical

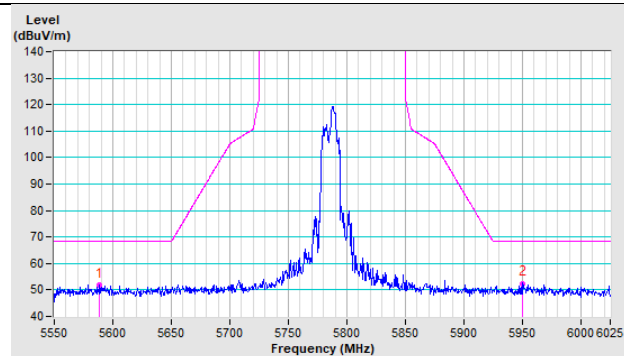

20MHz Preamble 802.11ax (RU52) CH 165 : 5825 MHz

Horizontal

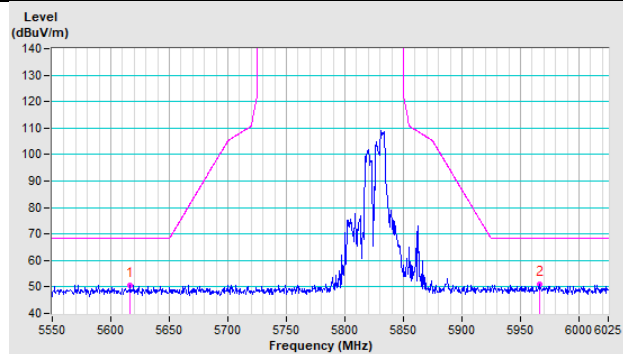

Vertical

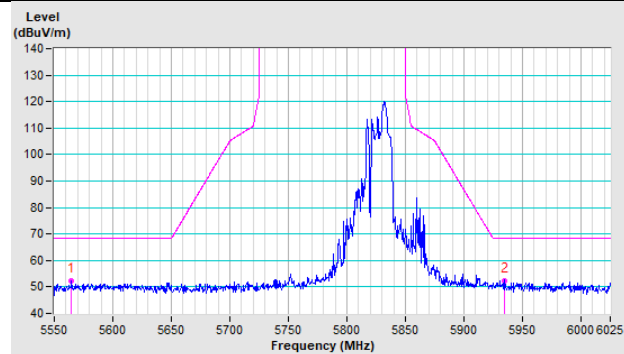

20MHz Preamble 802.11ax (RU106) CH 149 : 5745 MHz

Horizontal

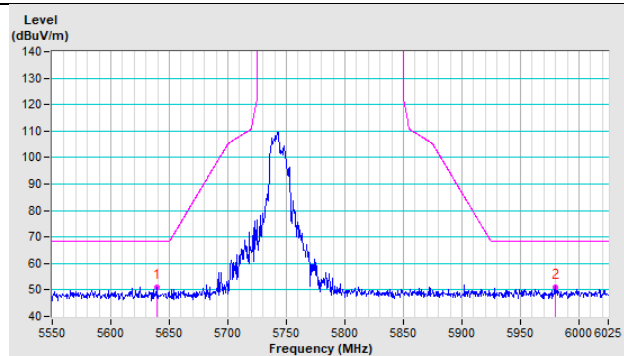

Vertical

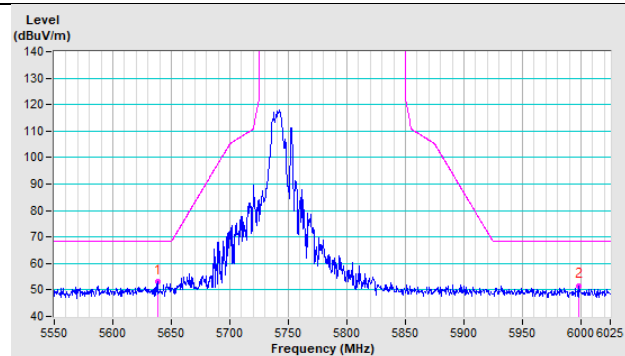

20MHz Preamble 802.11ax (RU106) CH 157 : 5785 MHz

Horizontal

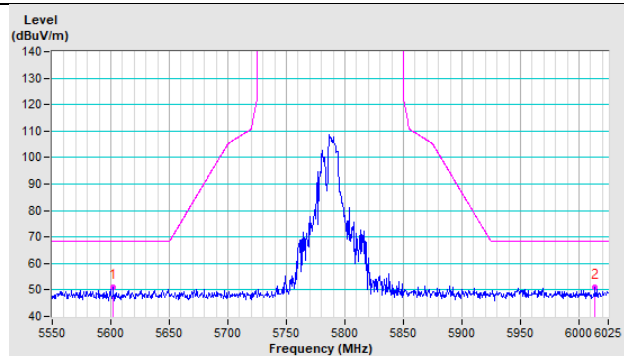

Vertical

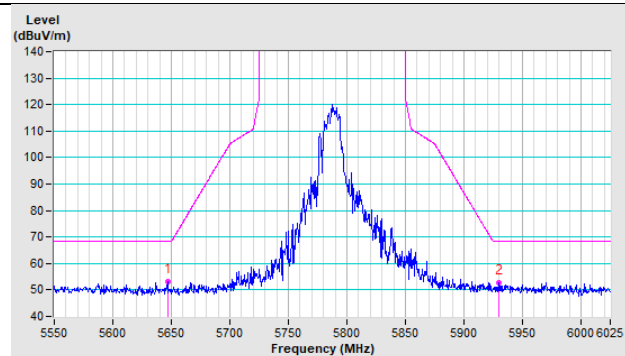

20MHz Preamble 802.11ax (RU106) CH 165 : 5825 MHz

Horizontal

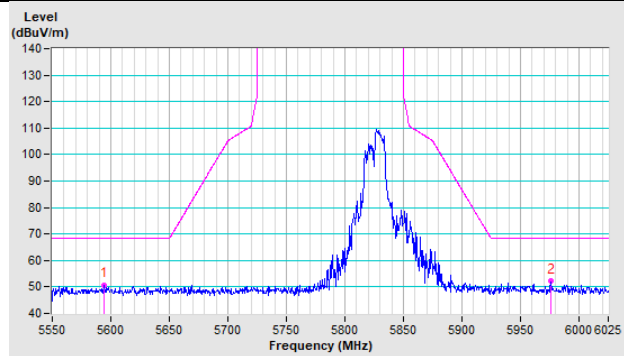

Vertical

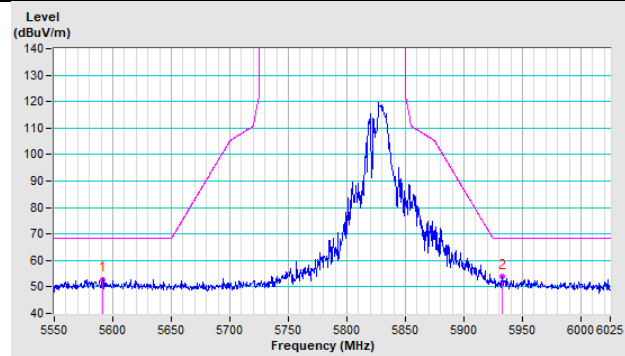

PIFA Antenna

802.11a CH 149 : 5745 MHz

Horizontal

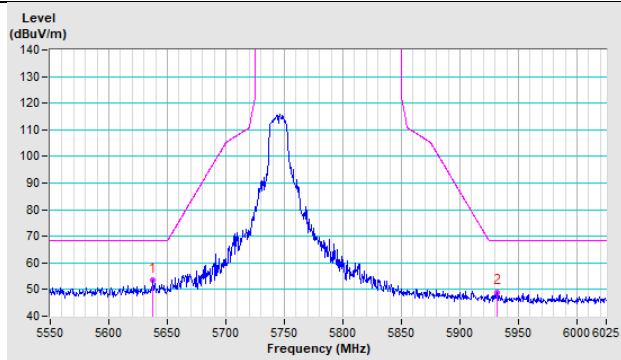

Vertical

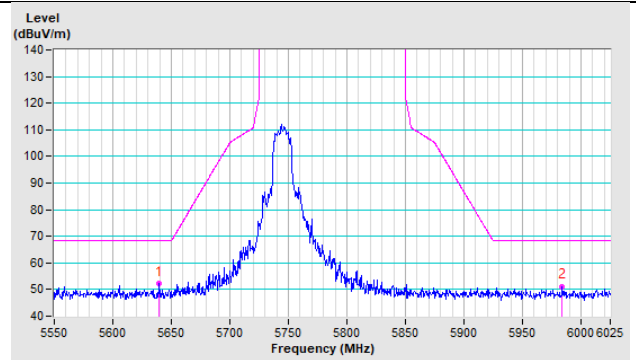

802.11a CH 157 : 5785 MHz

Horizontal

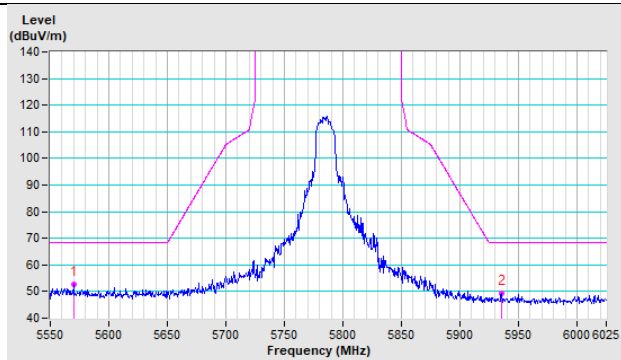

Vertical

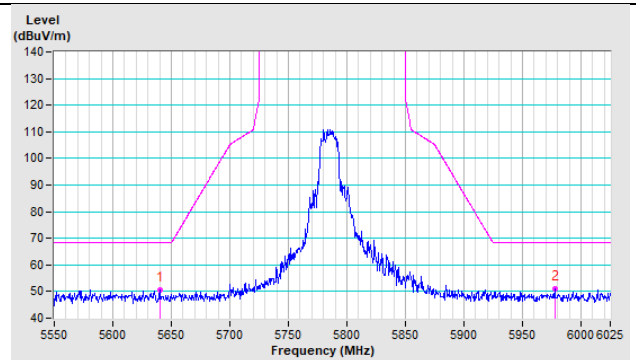

802.11a CH 165 : 5825 MHz

Horizontal

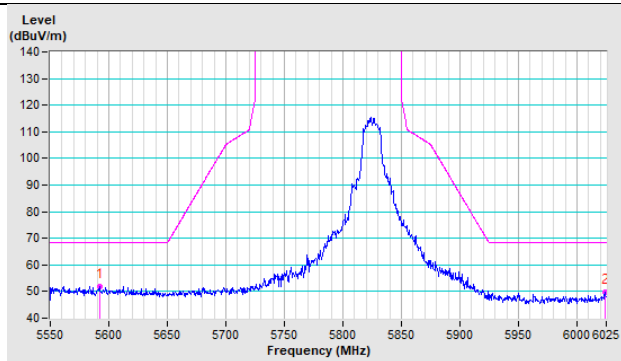

Vertical

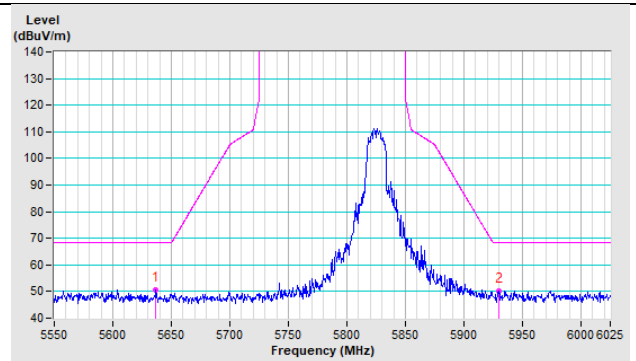

802.11ax (HE20) CH 149 : 5745 MHz

Horizontal

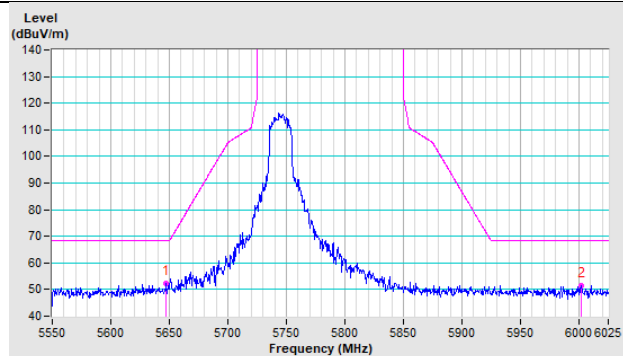

Vertical

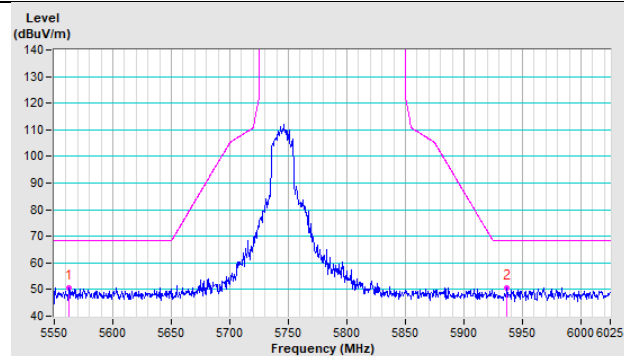

802.11ax (HE20) CH 157 : 5785 MHz

Horizontal

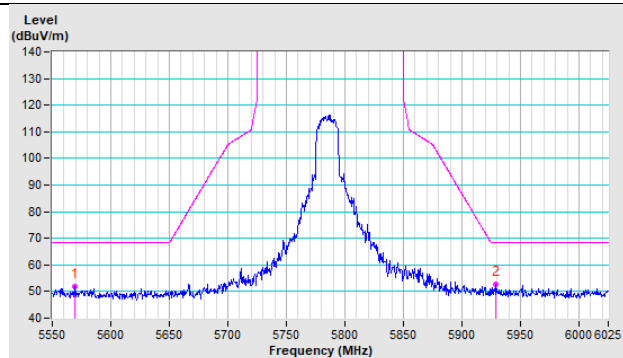

Vertical

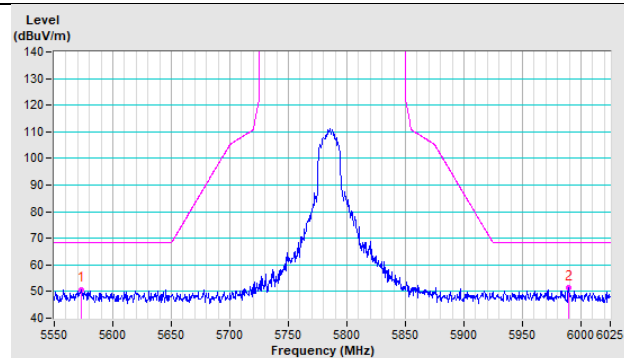

802.11ax (HE20) CH 165 : 5825 MHz

Horizontal

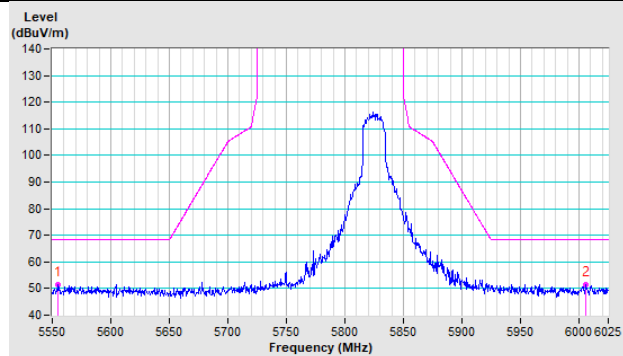

Vertical

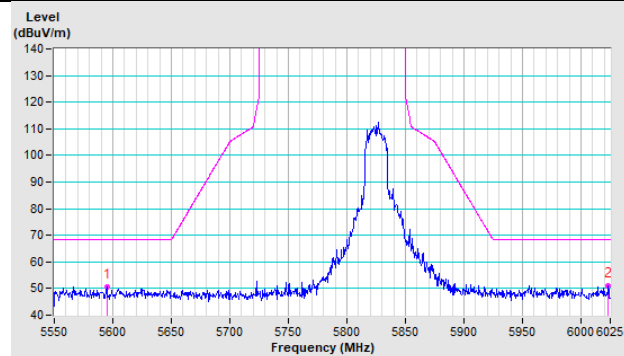

802.11ax (HE40) CH 151 : 5755 MHz

Horizontal

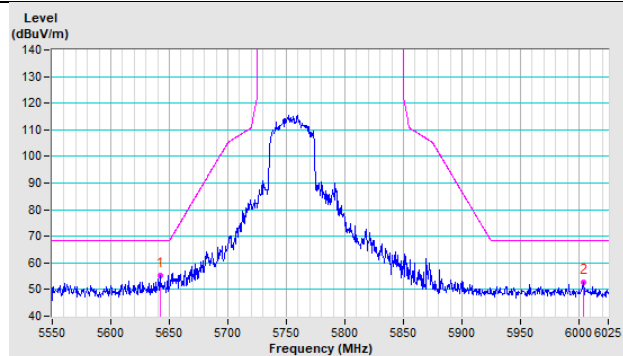

Vertical

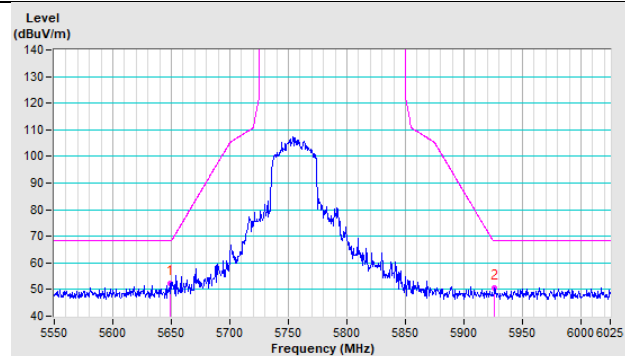

802.11ax (HE40) CH 159 : 5795 MHz

Horizontal

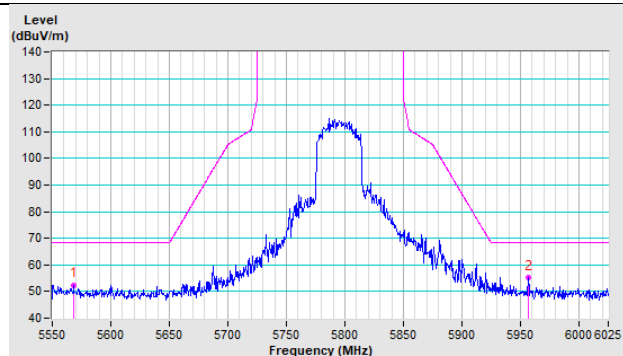

Vertical

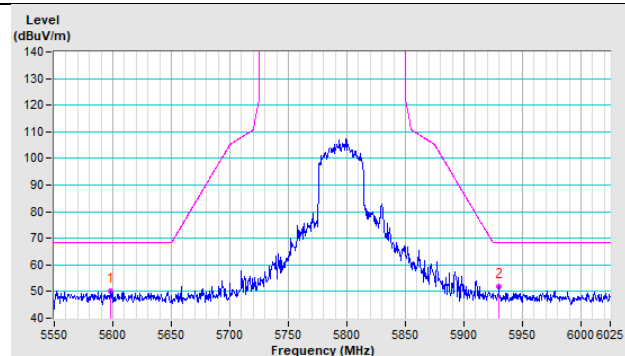

802.11ax (HE80) CH 155 : 5775 MHz

Horizontal

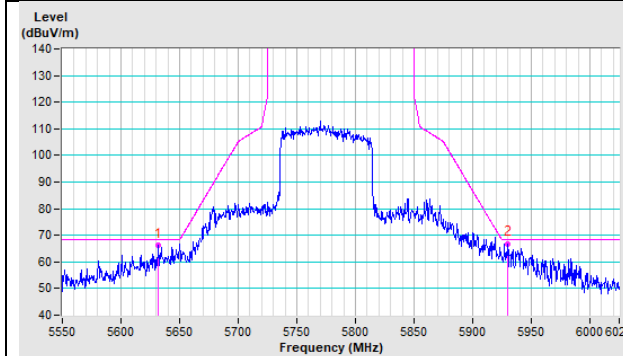

Vertical

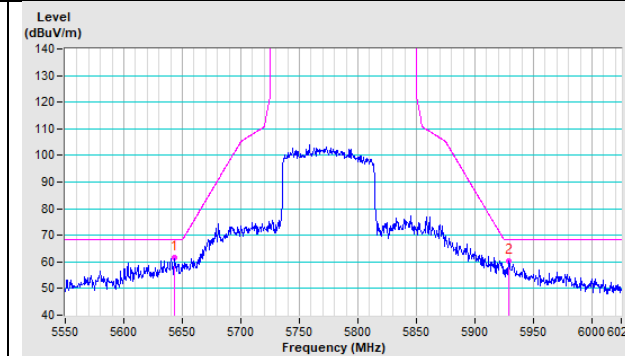

20MHz Preamble 802.11ax (RU26) CH 149 : 5745 MHz

Horizontal

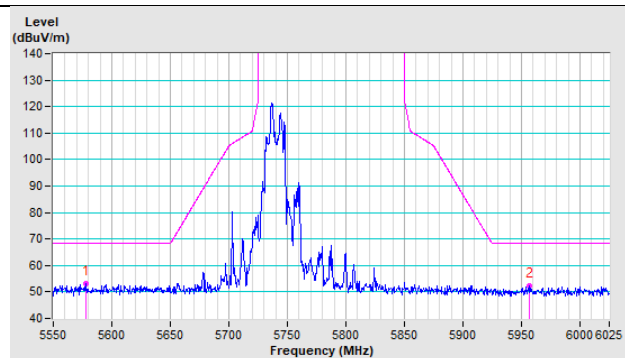

Vertical

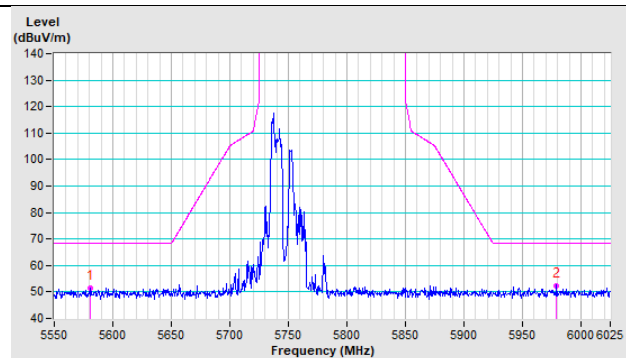

20MHz Preamble 802.11ax (RU26) CH 157 : 5785 MHz

Horizontal

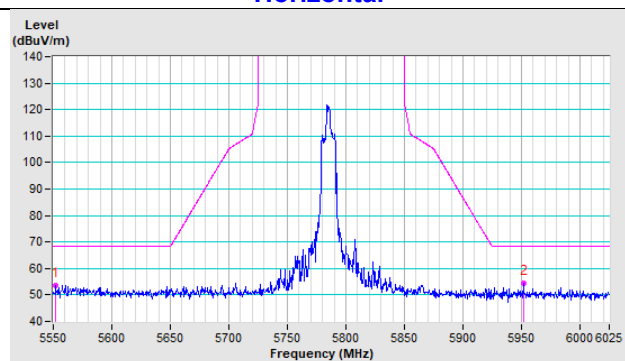

Vertical

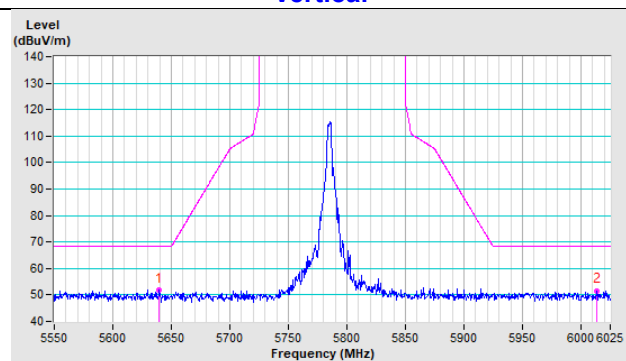

20MHz Preamble 802.11ax (RU26) CH 165 : 5825 MHz

Horizontal

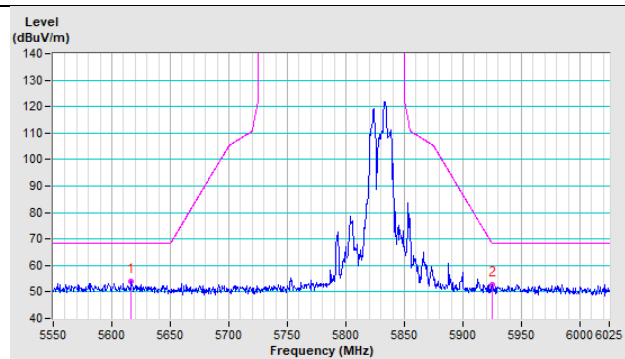

Vertical

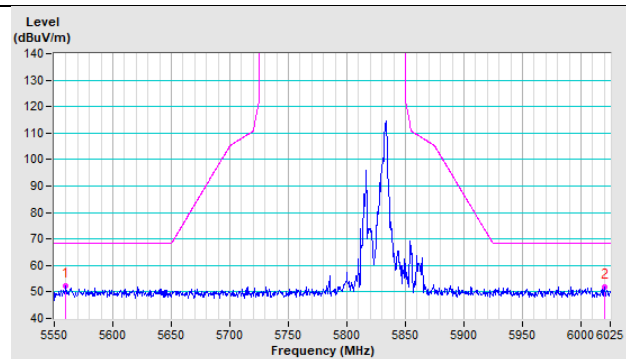

20MHz Preamble 802.11ax (RU52) CH 149 : 5745 MHz

Horizontal

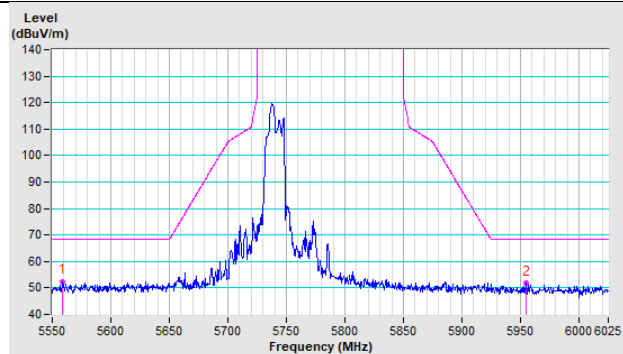

Vertical

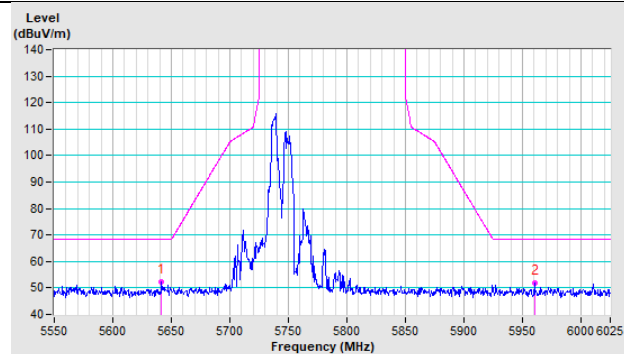

20MHz Preamble 802.11ax (RU52) CH 157 : 5785 MHz

Horizontal

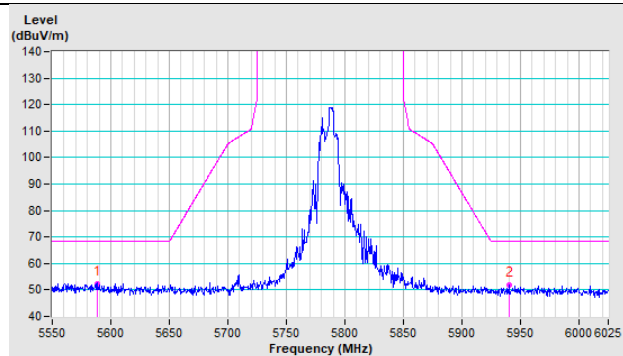

Vertical

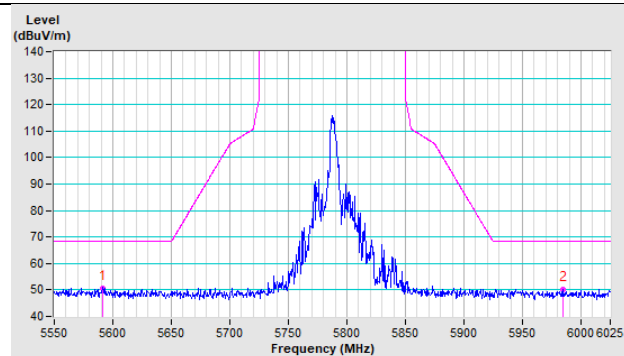

20MHz Preamble 802.11ax (RU52) CH 165 : 5825 MHz

Horizontal

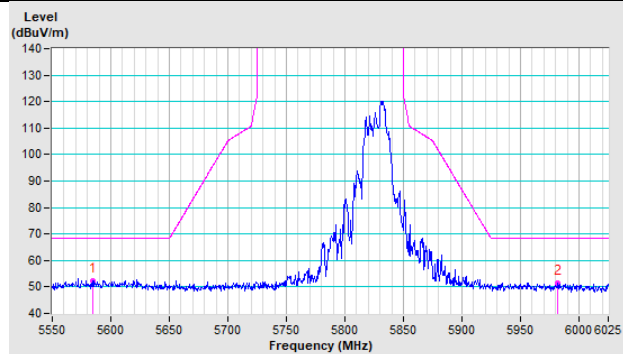

Vertical

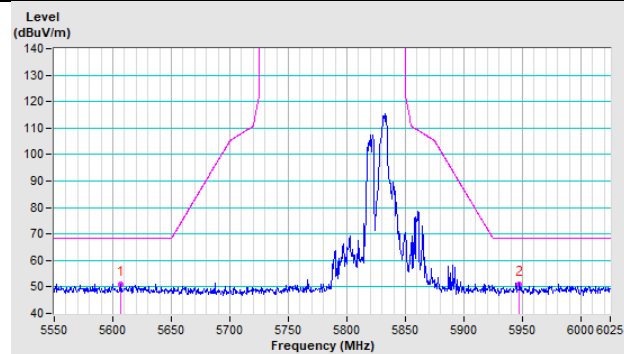

20MHz Preamble 802.11ax (RU106) CH 149 : 5745 MHz

Horizontal

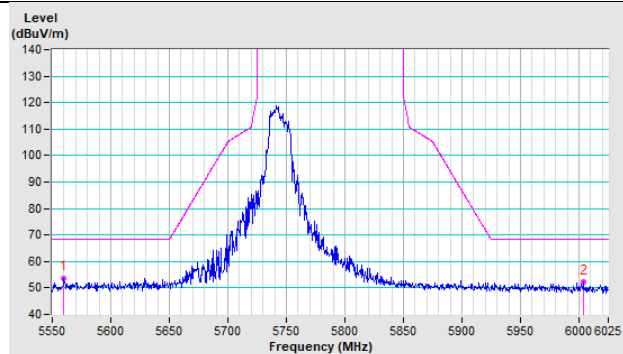

Vertical

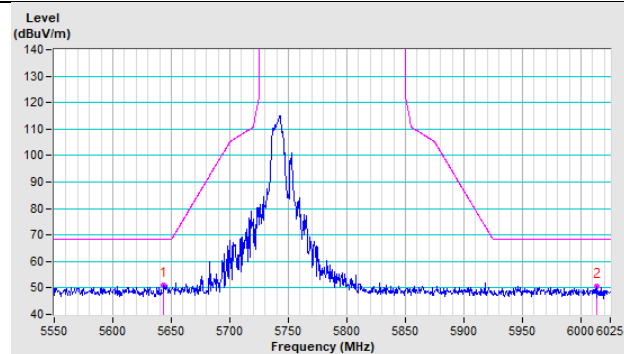

20MHz Preamble 802.11ax (RU106) CH 157 : 5785 MHz

Horizontal

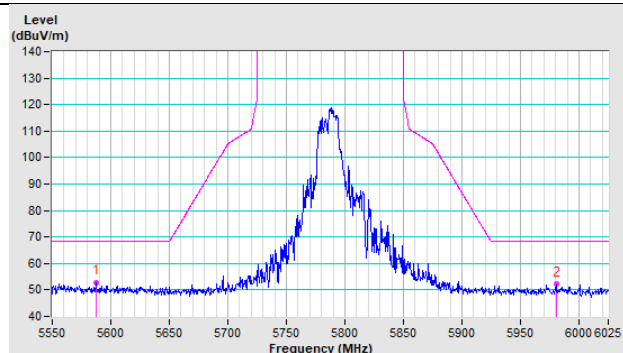

Vertical

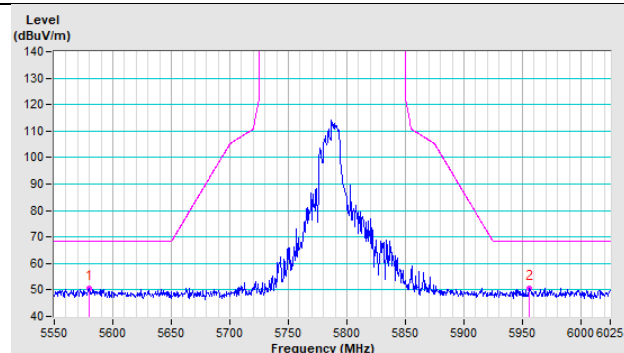

20MHz Preamble 802.11ax (RU106) CH 165 : 5825 MHz

Horizontal

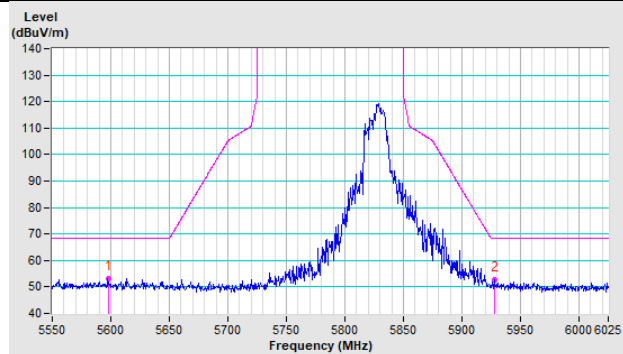

Vertical

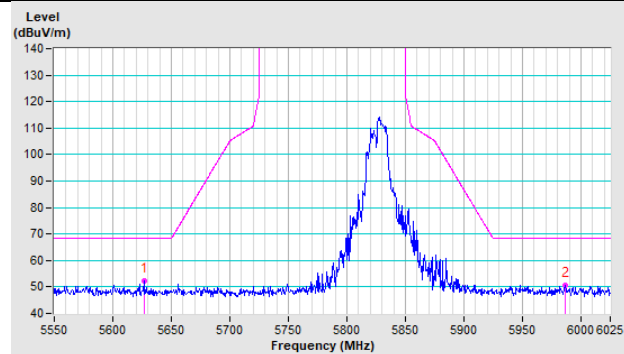

Annex A.2 - Test Results (Mode 2)

Dipole Antenna

802.11a CH 149 : 5745 MHz

Horizontal

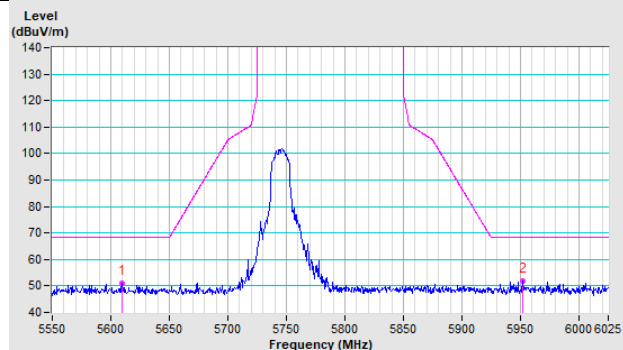

Vertical

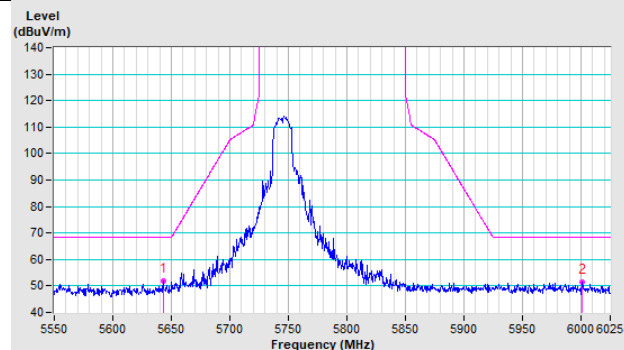

802.11a CH 157 : 5785 MHz

Horizontal

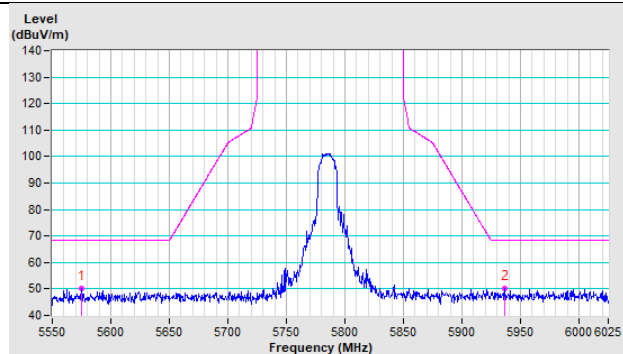

Vertical

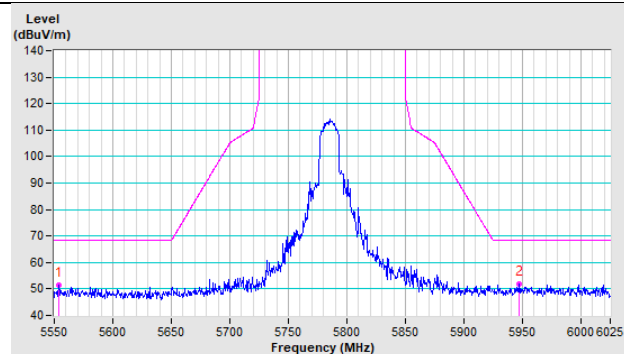

802.11a CH 165 : 5825 MHz

Horizontal

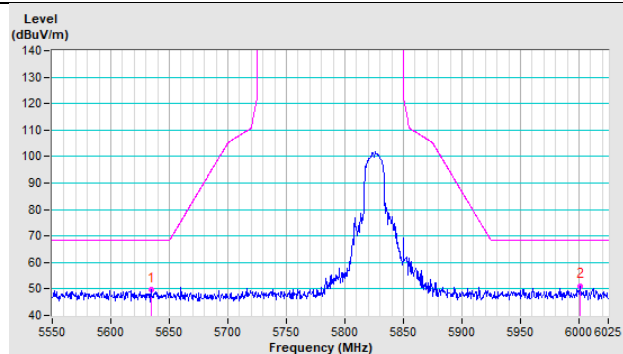

Vertical

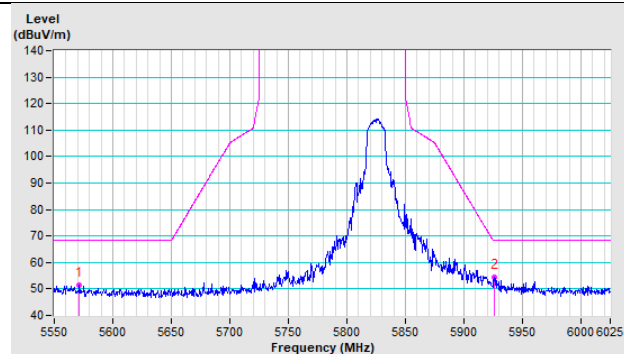

802.11ax (HE20) CH 149 : 5745 MHz

Horizontal

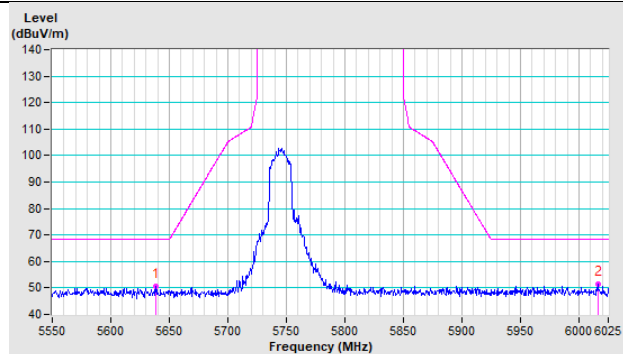

Vertical

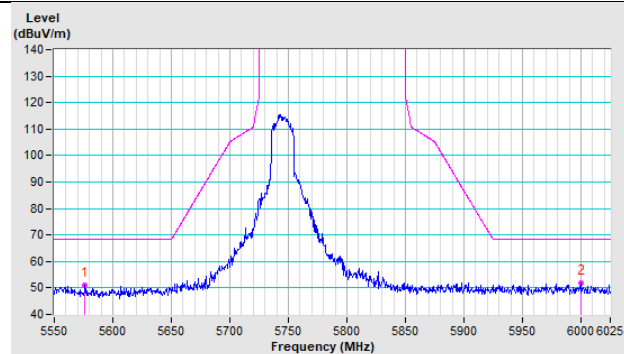

802.11ax (HE20) CH 157 : 5785 MHz

Horizontal

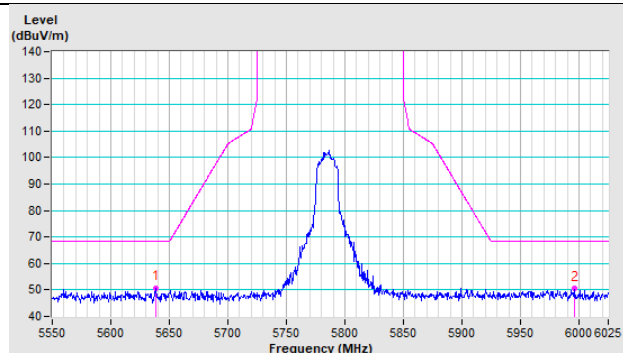

Vertical

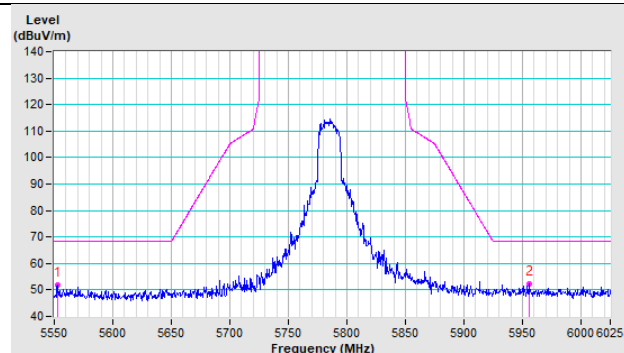

802.11ax (HE20) CH 165 : 5825 MHz

Horizontal

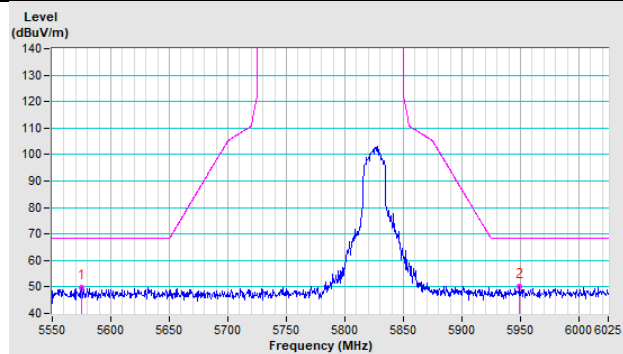

Vertical

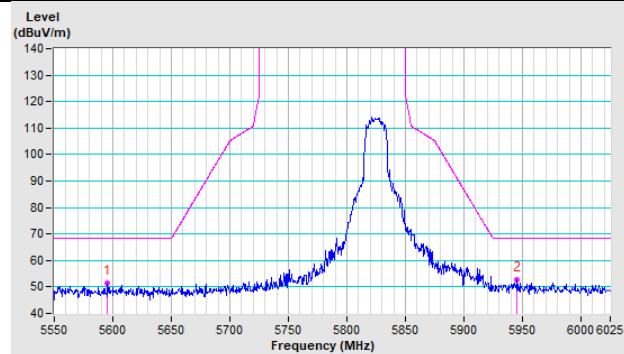

802.11ax (HE40) CH 151 : 5755 MHz

Horizontal

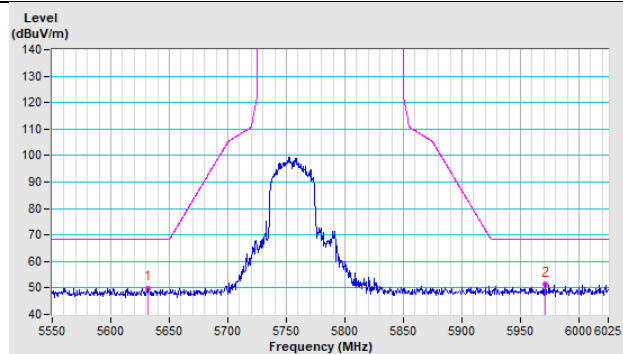

Vertical

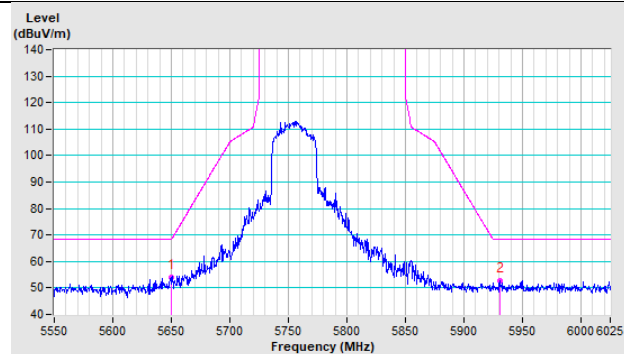

802.11ax (HE40) CH 159 : 5795 MHz

Horizontal

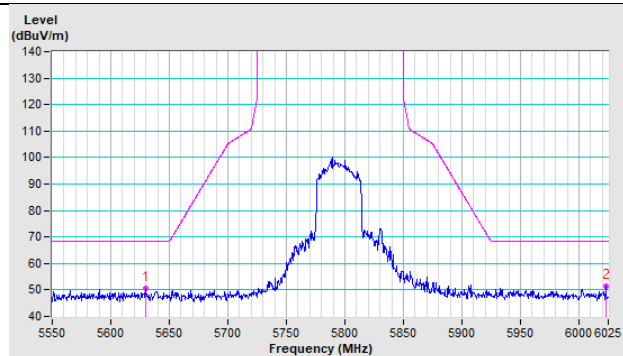

Vertical

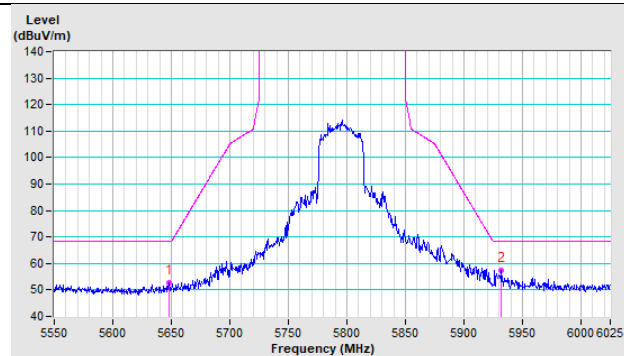

802.11ax (HE80) CH 155 : 5775 MHz

Horizontal

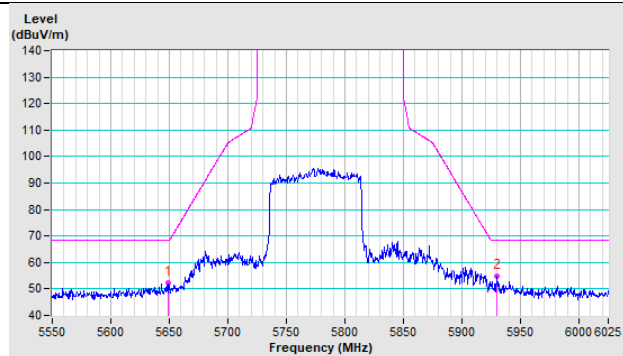

Vertical

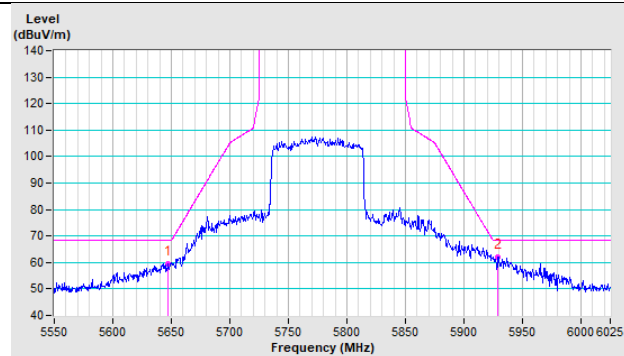

20MHz Preamble 802.11ax (RU26) CH 149 : 5745 MHz

Horizontal

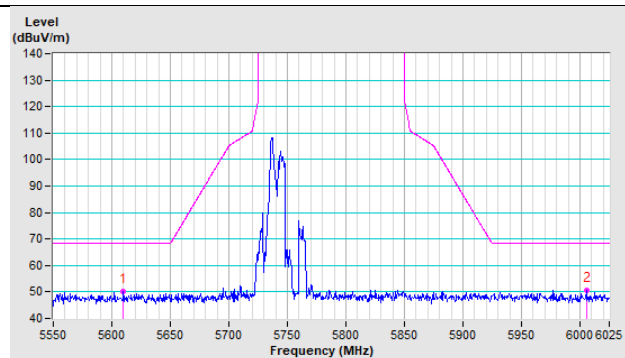

Vertical

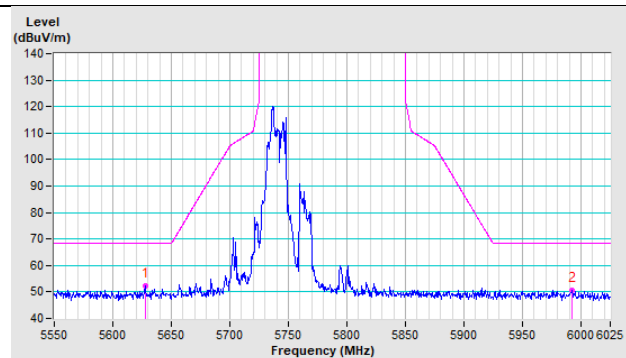

20MHz Preamble 802.11ax (RU26) CH 157 : 5785 MHz

Horizontal

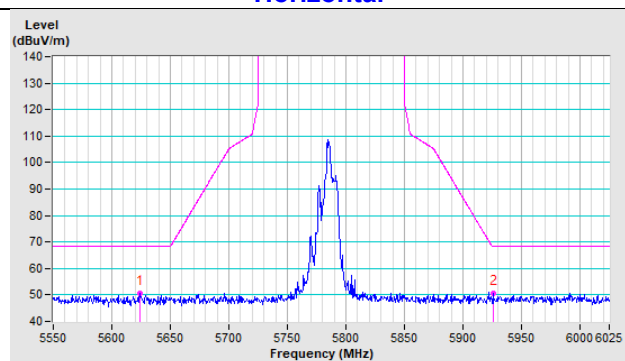

Vertical

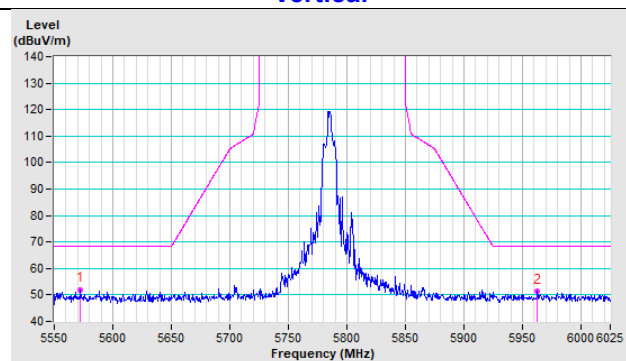

20MHz Preamble 802.11ax (RU26) CH 165 : 5825 MHz

Horizontal

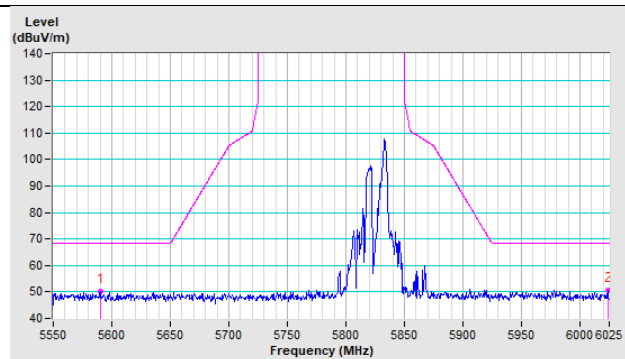

Vertical

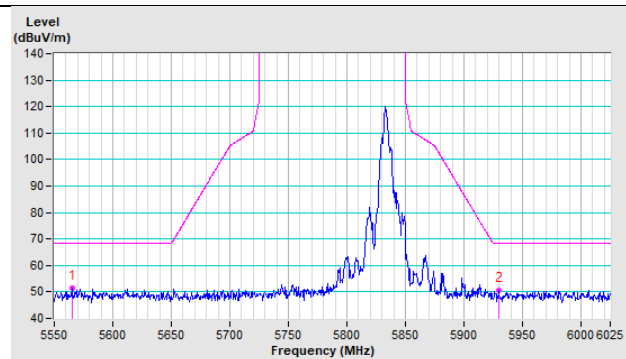

20MHz Preamble 802.11ax (RU52) CH 149 : 5745 MHz

Horizontal

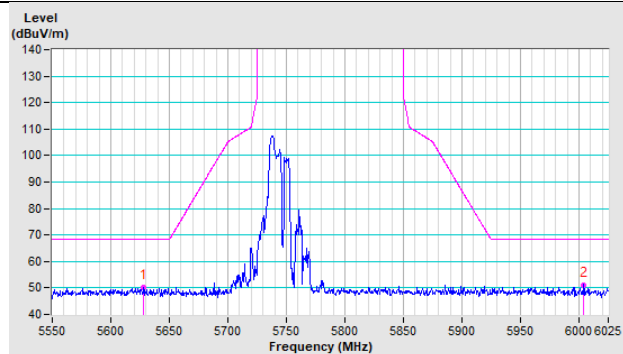

Vertical

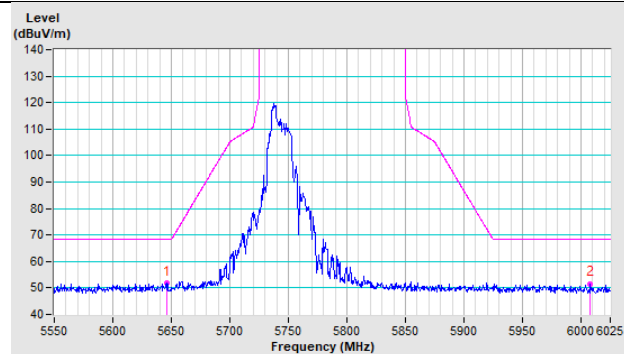

20MHz Preamble 802.11ax (RU52) CH 157 : 5785 MHz

Horizontal

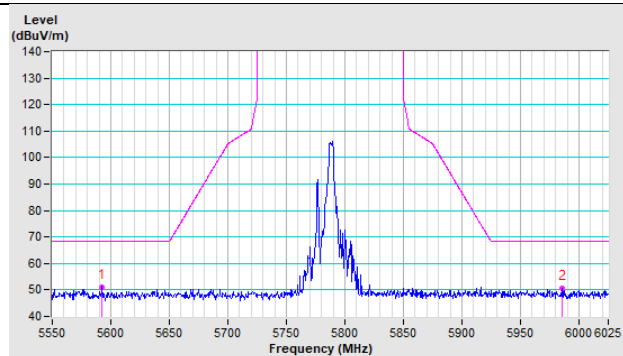

Vertical

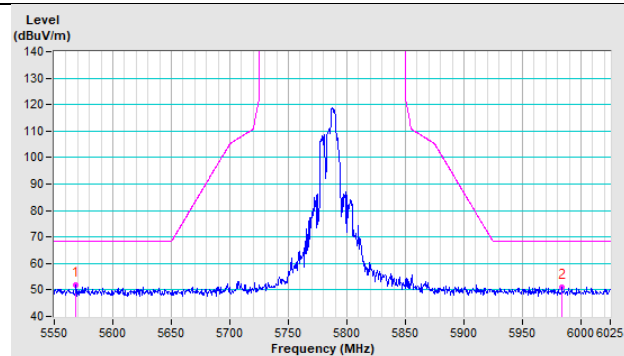

20MHz Preamble 802.11ax (RU52) CH 165 : 5825 MHz

Horizontal

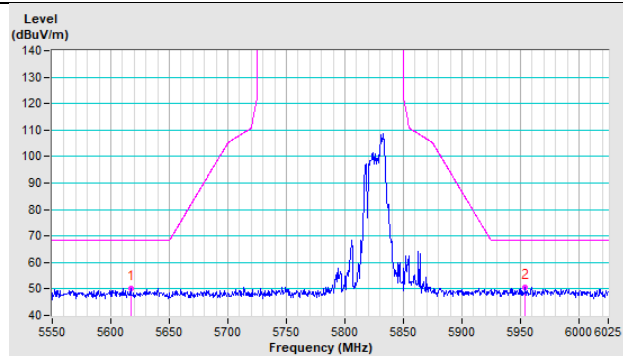

Vertical

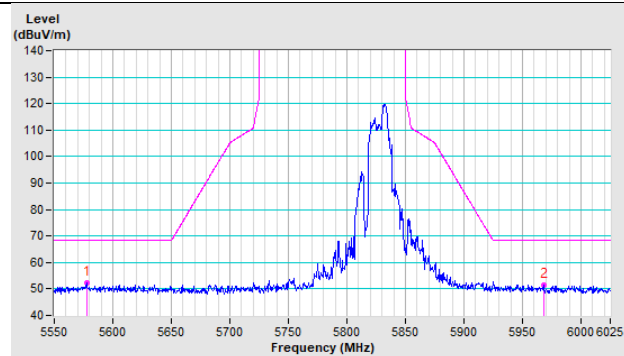

20MHz Preamble 802.11ax (RU106) CH 149 : 5745 MHz

Horizontal

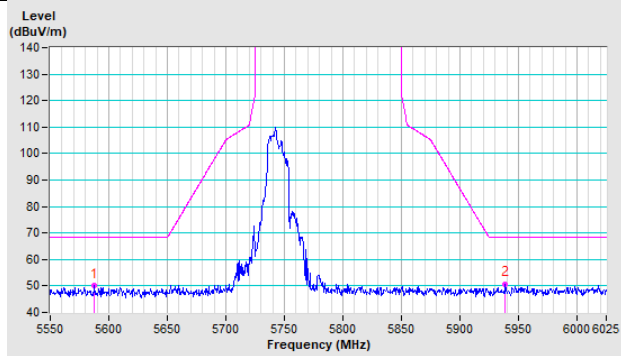

Vertical

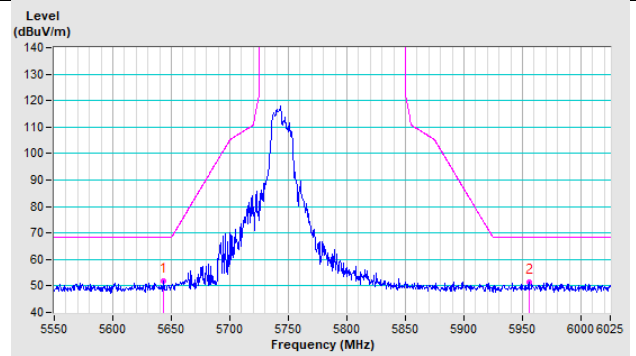

20MHz Preamble 802.11ax (RU106) CH 157 : 5785 MHz

Horizontal

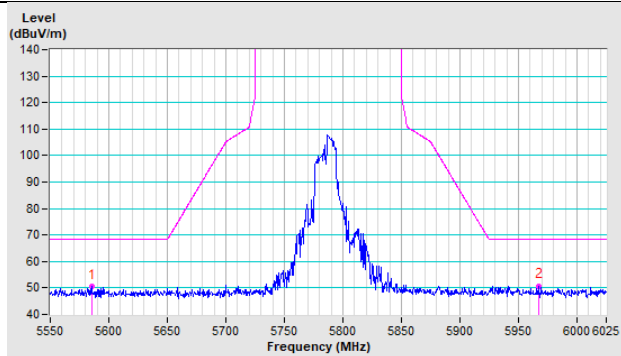

Vertical

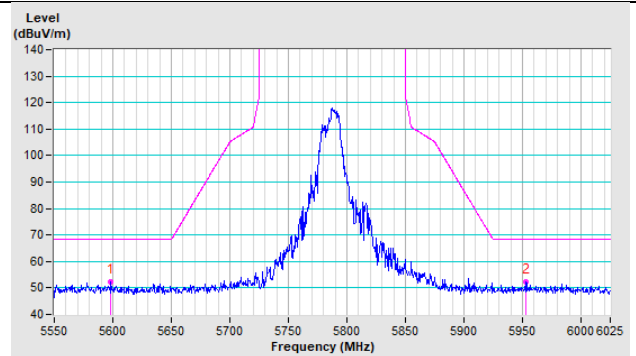

20MHz Preamble 802.11ax (RU106) CH 165 : 5825 MHz

Horizontal

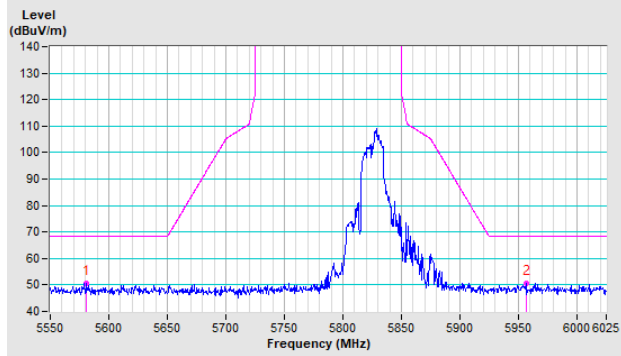

Vertical

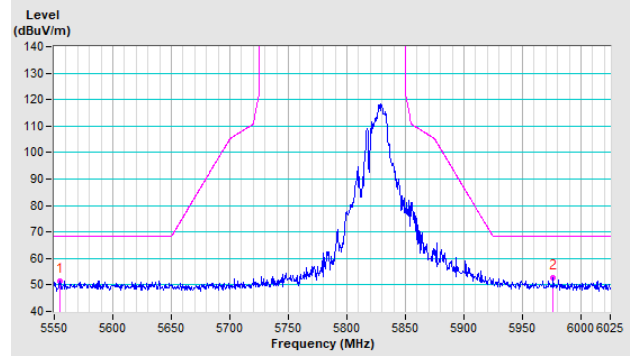

PIFA Antenna

802.11a CH 149 : 5745 MHz

Horizontal

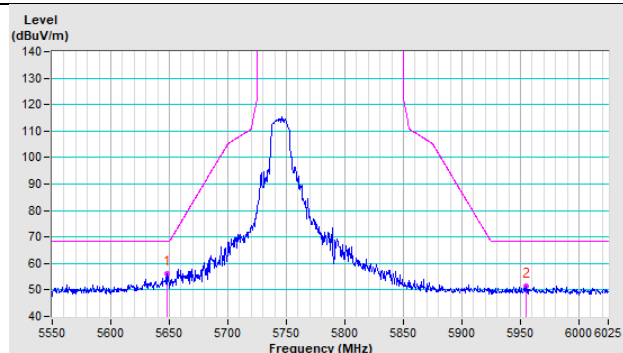

Vertical

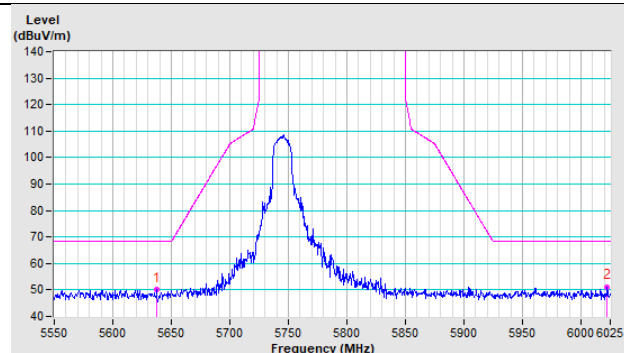

802.11a CH 157 : 5785 MHz

Horizontal

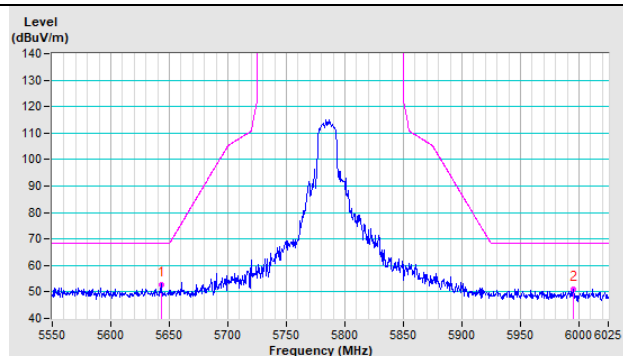

Vertical

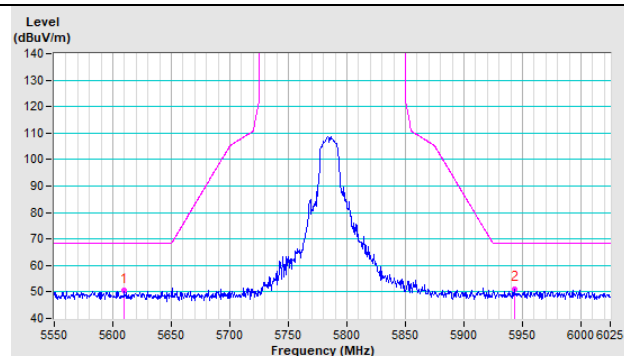

802.11a CH 165 : 5825 MHz

Horizontal

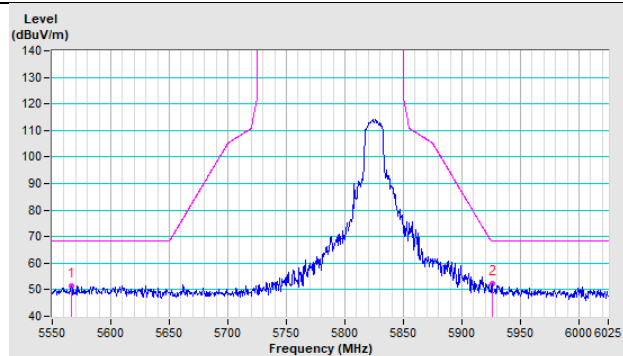

Vertical

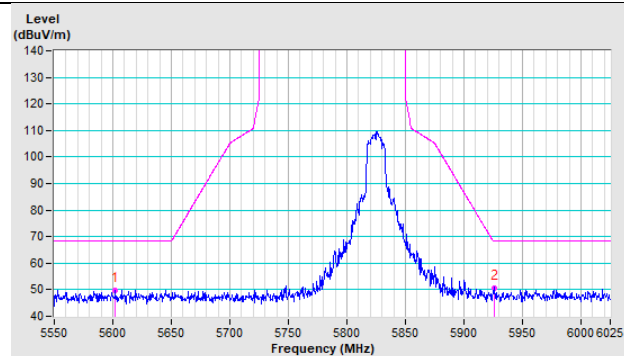

802.11ax (HE20) CH 149 : 5745 MHz

Horizontal

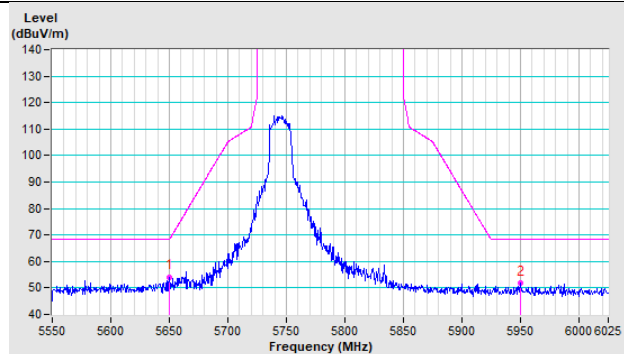

Vertical

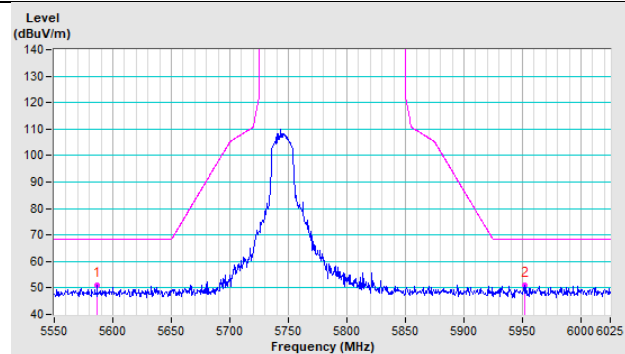

802.11ax (HE20) CH 157 : 5785 MHz

Horizontal

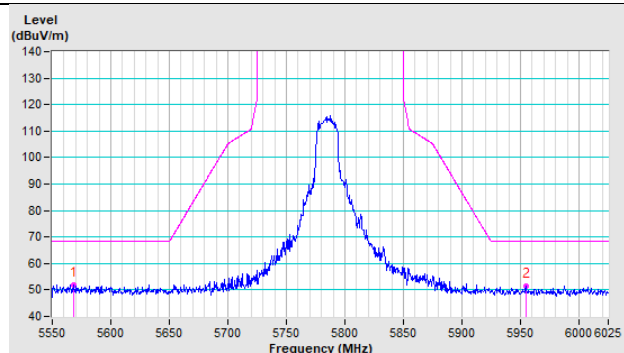

Vertical

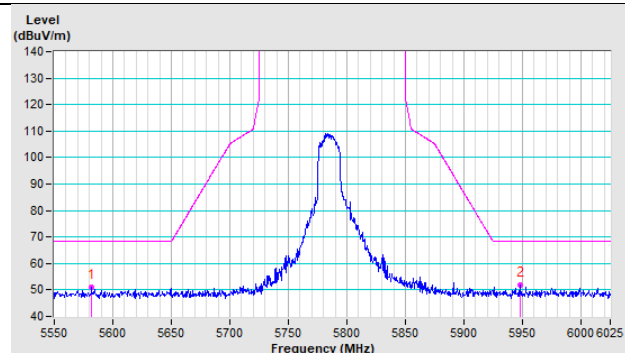

802.11ax (HE20) CH 165 : 5825 MHz

Horizontal

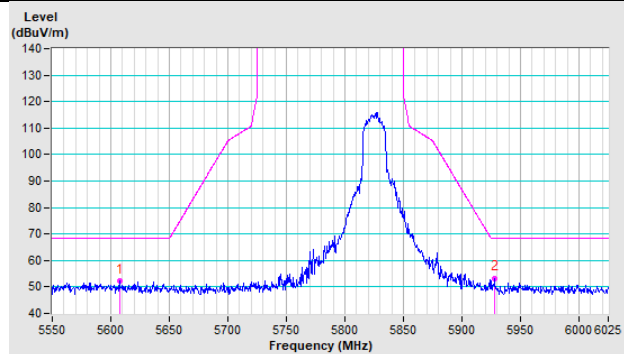

Vertical

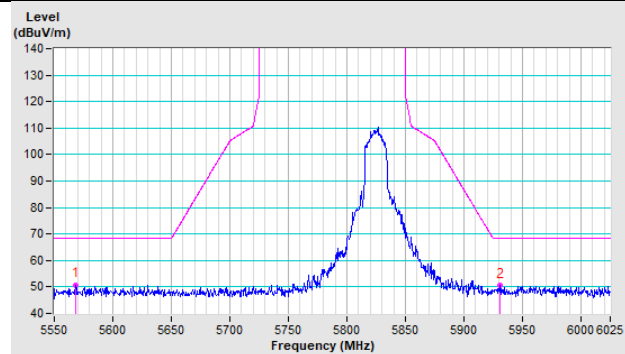

802.11ax (HE40) CH 151 : 5755 MHz

Horizontal

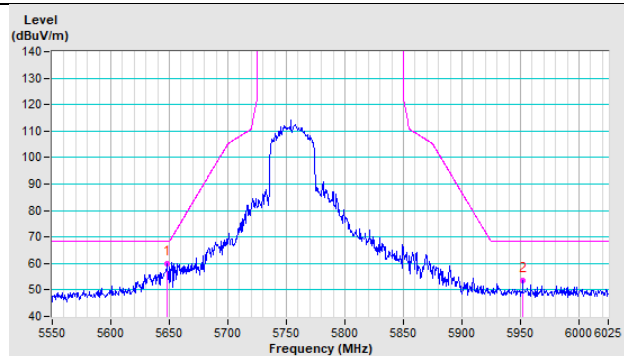

Vertical

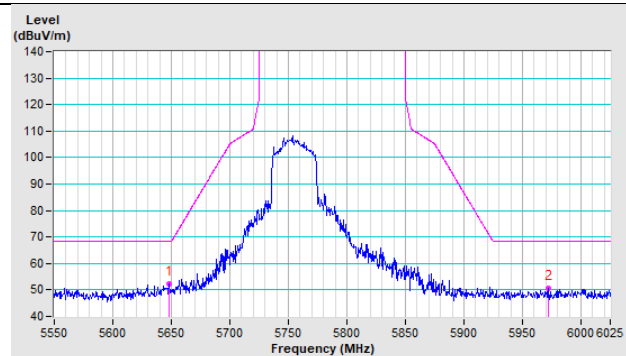

802.11ax (HE40) CH 159 : 5795 MHz

Horizontal

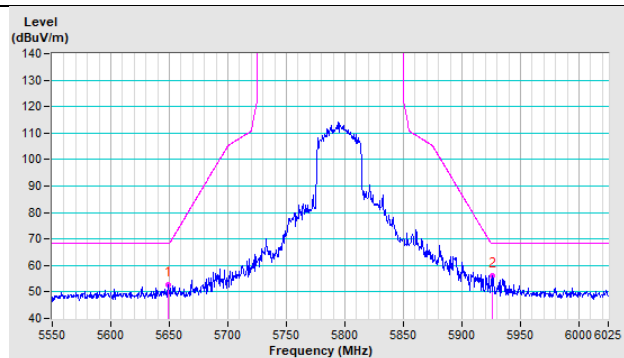

Vertical

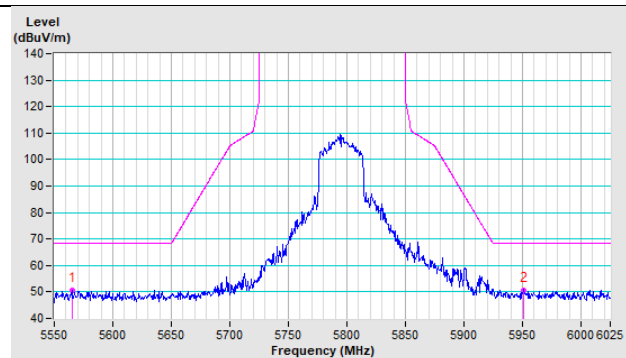

802.11ax (HE80) CH 155 : 5775 MHz

Horizontal

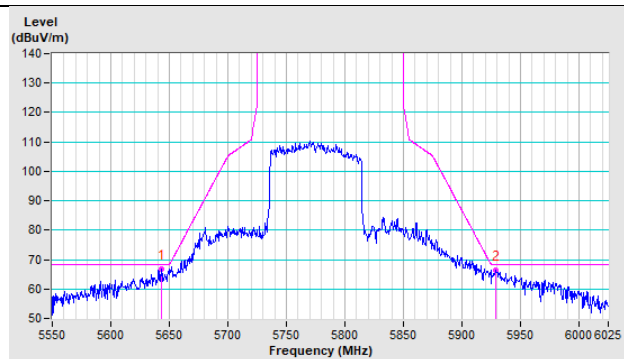

Vertical

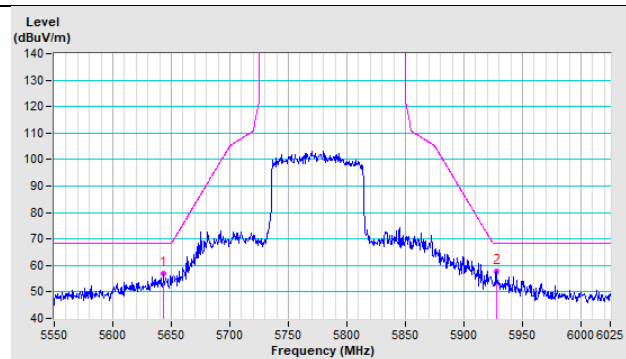

20MHz Preamble 802.11ax (RU26) CH 149 : 5745 MHz

Horizontal

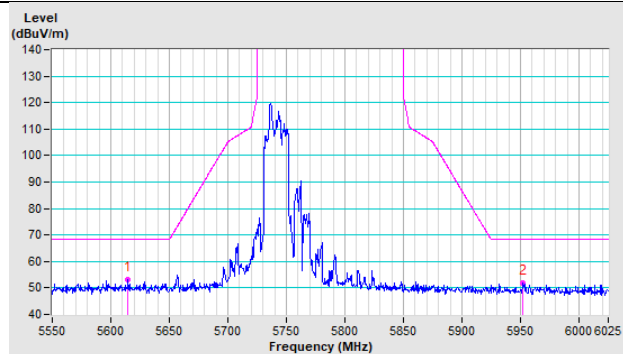

Vertical

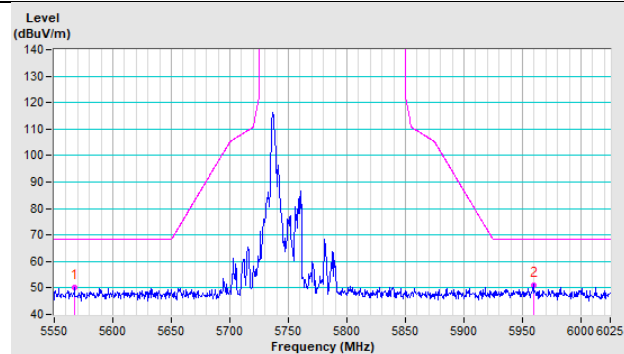

20MHz Preamble 802.11ax (RU26) CH 157 : 5785 MHz

Horizontal

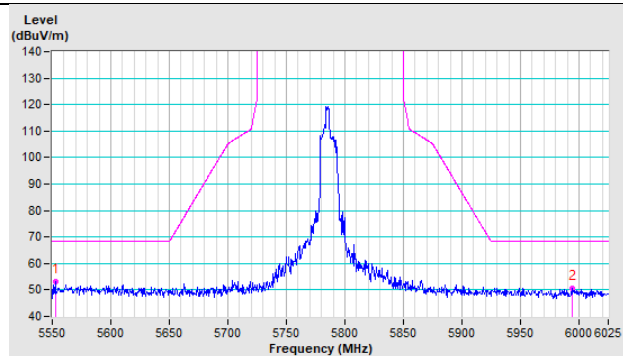

Vertical

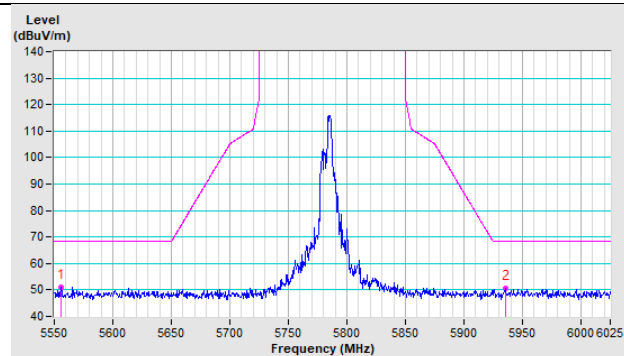

20MHz Preamble 802.11ax (RU26) CH 165 : 5825 MHz

Horizontal

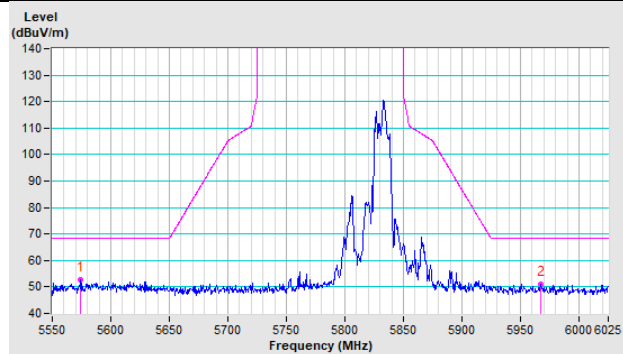

Vertical

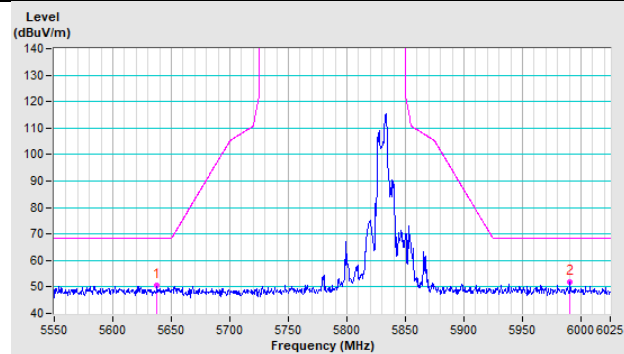

20MHz Preamble 802.11ax (RU52) CH 149 : 5745 MHz

Horizontal

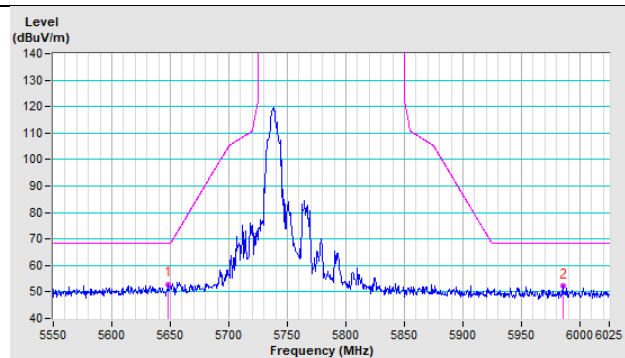

Vertical

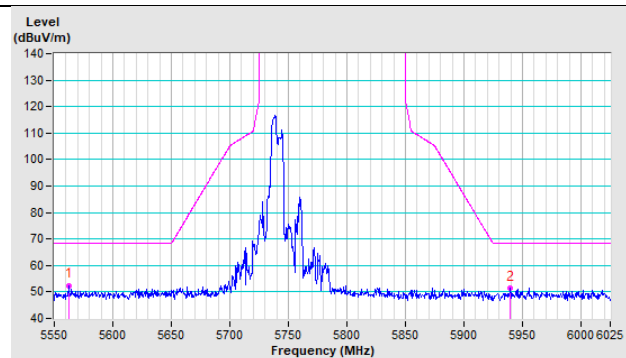

20MHz Preamble 802.11ax (RU52) CH 157 : 5785 MHz

Horizontal

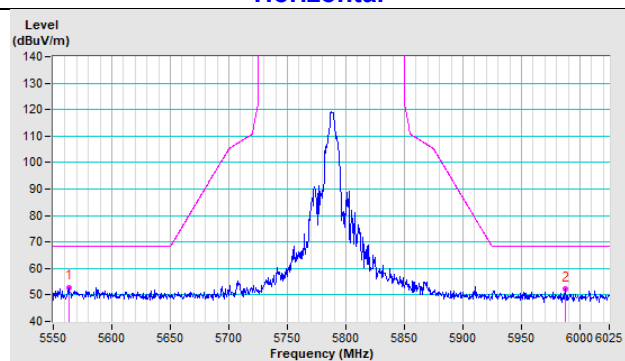

Vertical

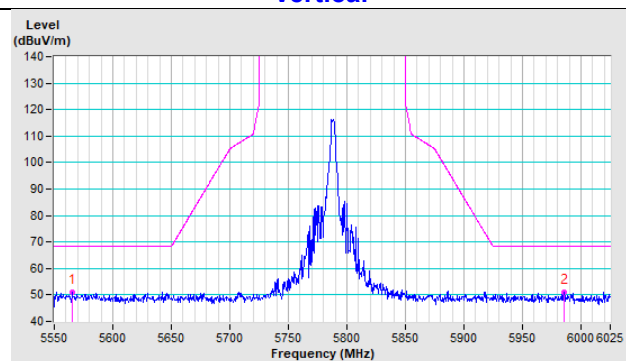

20MHz Preamble 802.11ax (RU52) CH 165 : 5825 MHz

Horizontal

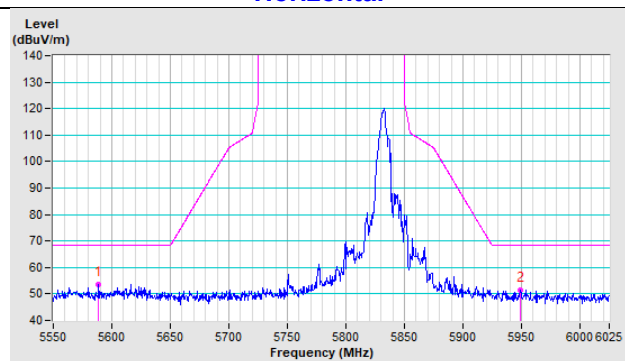

Vertical

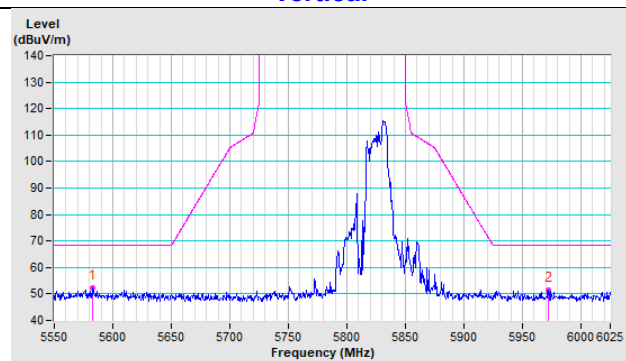

20MHz Preamble 802.11ax (RU106) CH 149 : 5745 MHz

Horizontal

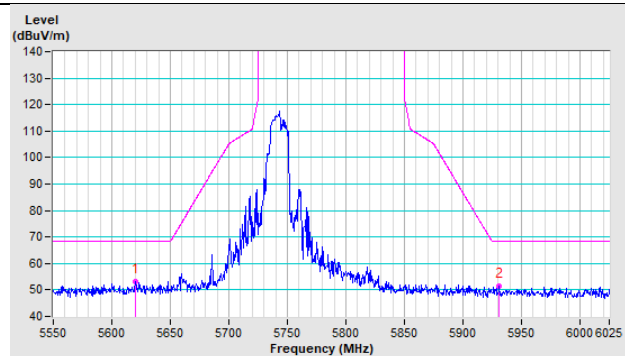

Vertical

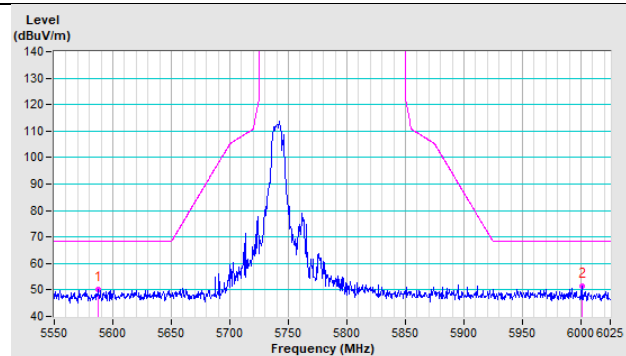

20MHz Preamble 802.11ax (RU106) CH 157 : 5785 MHz

Horizontal

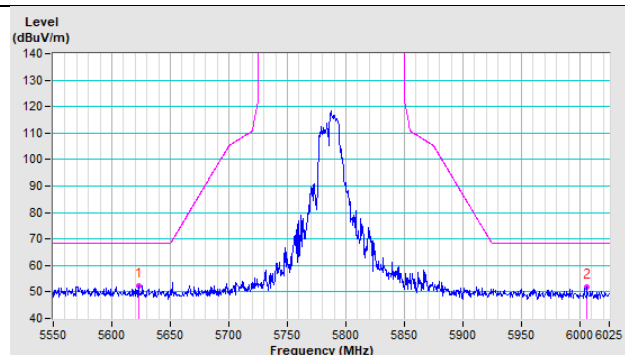

Vertical

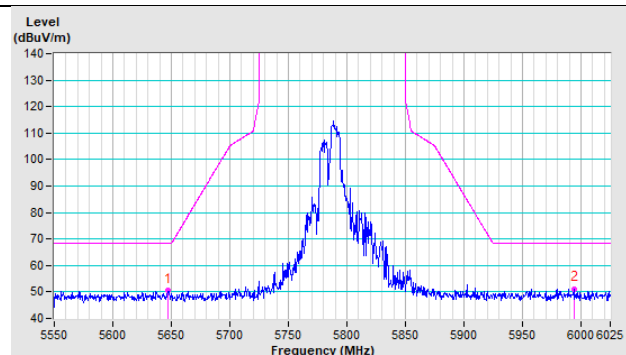

20MHz Preamble 802.11ax (RU106) CH 165 : 5825 MHz

Horizontal

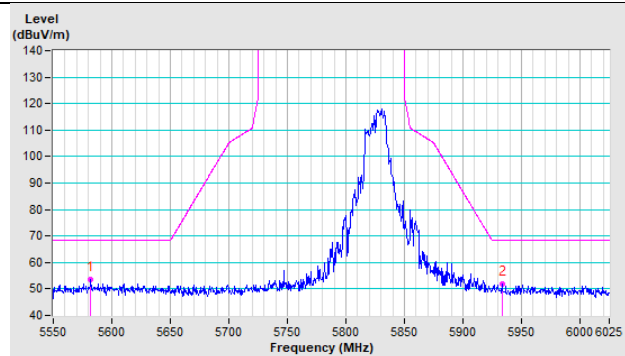

Vertical

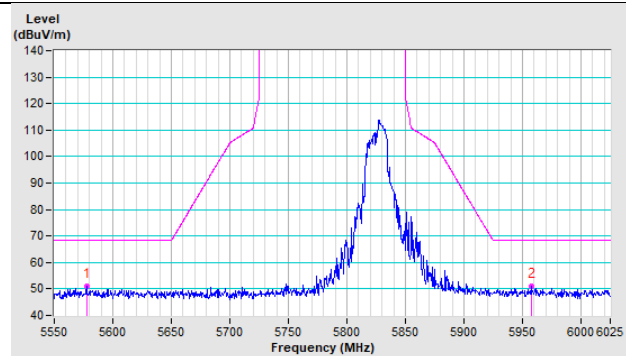

Annex B - Band-Edge Measurement (For U-NII-1, U-NII-2A, U-NII-2C band)

Annex B.1 - Test Results (Mode 1)

Dipole Antenna

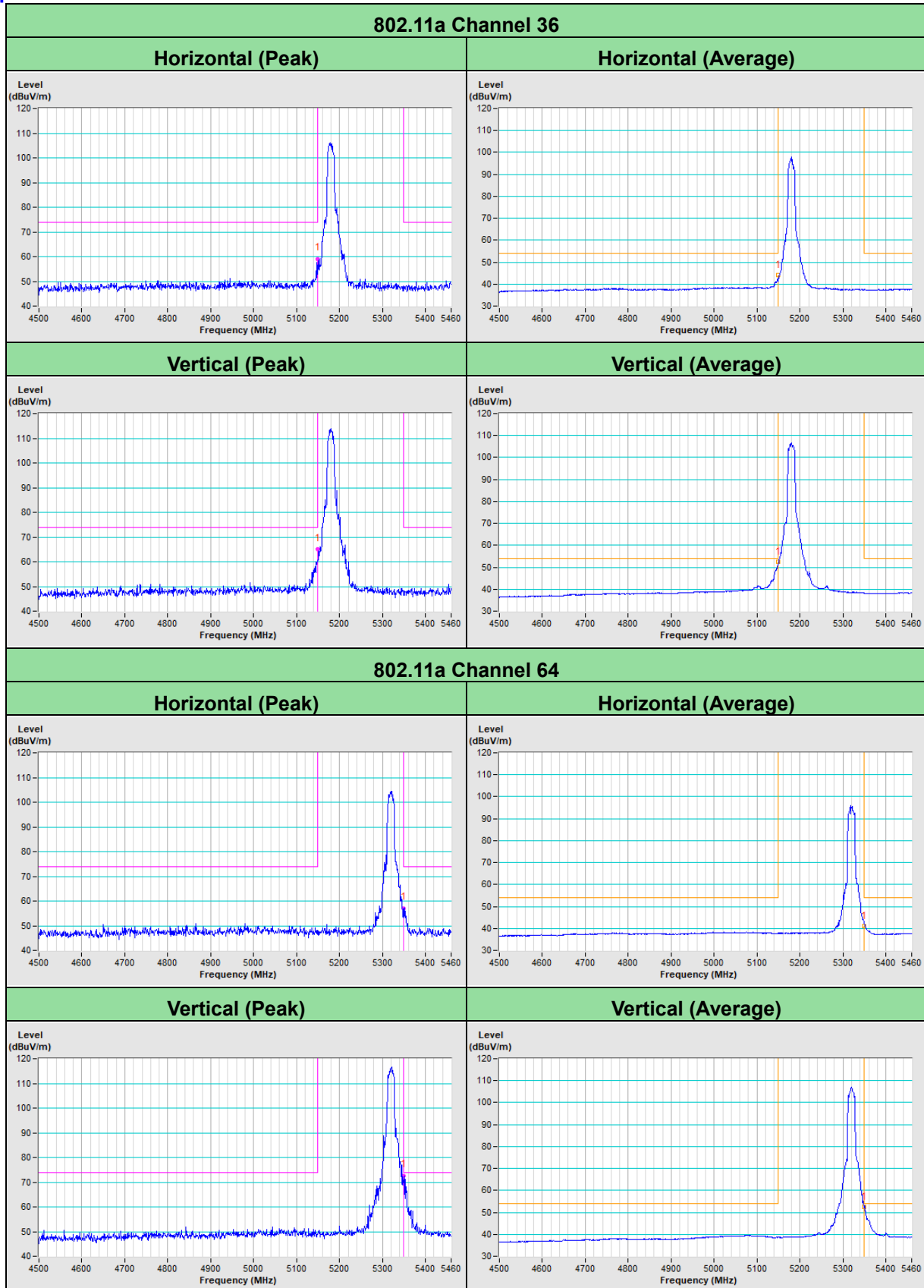

802.11a Channel 100

Horizontal (Peak)

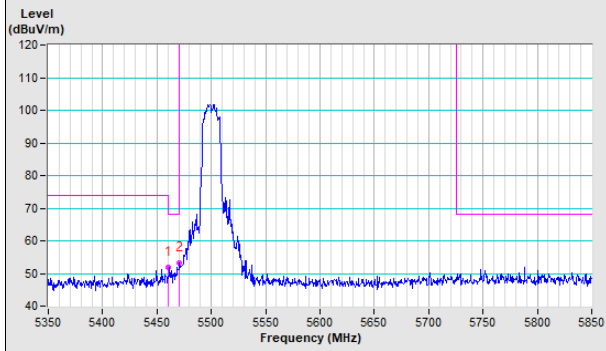

Horizontal (Average)

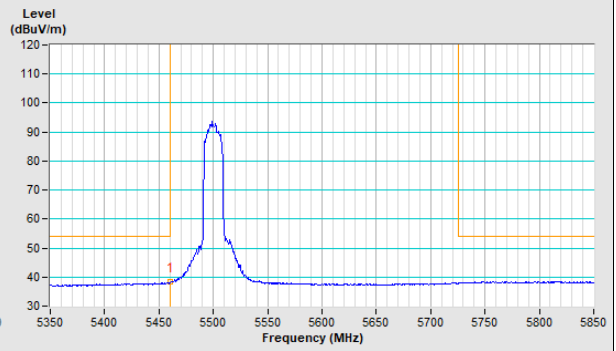

Vertical (Peak)

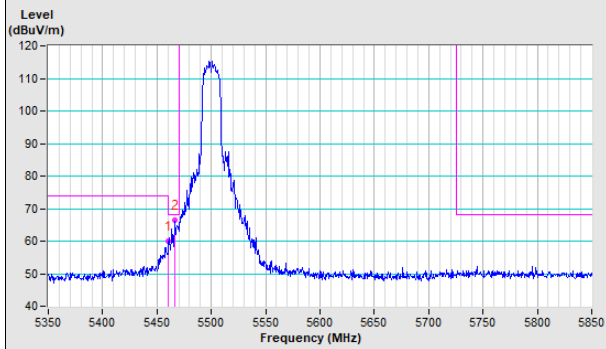

Vertical (Average)

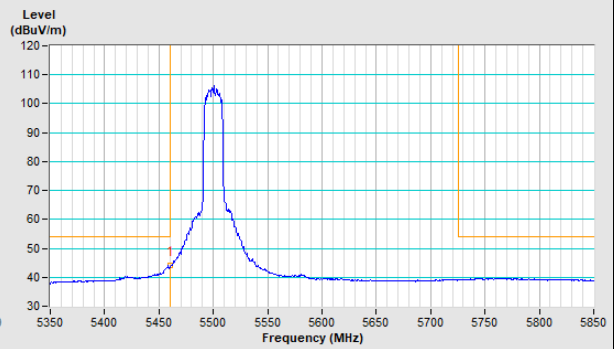

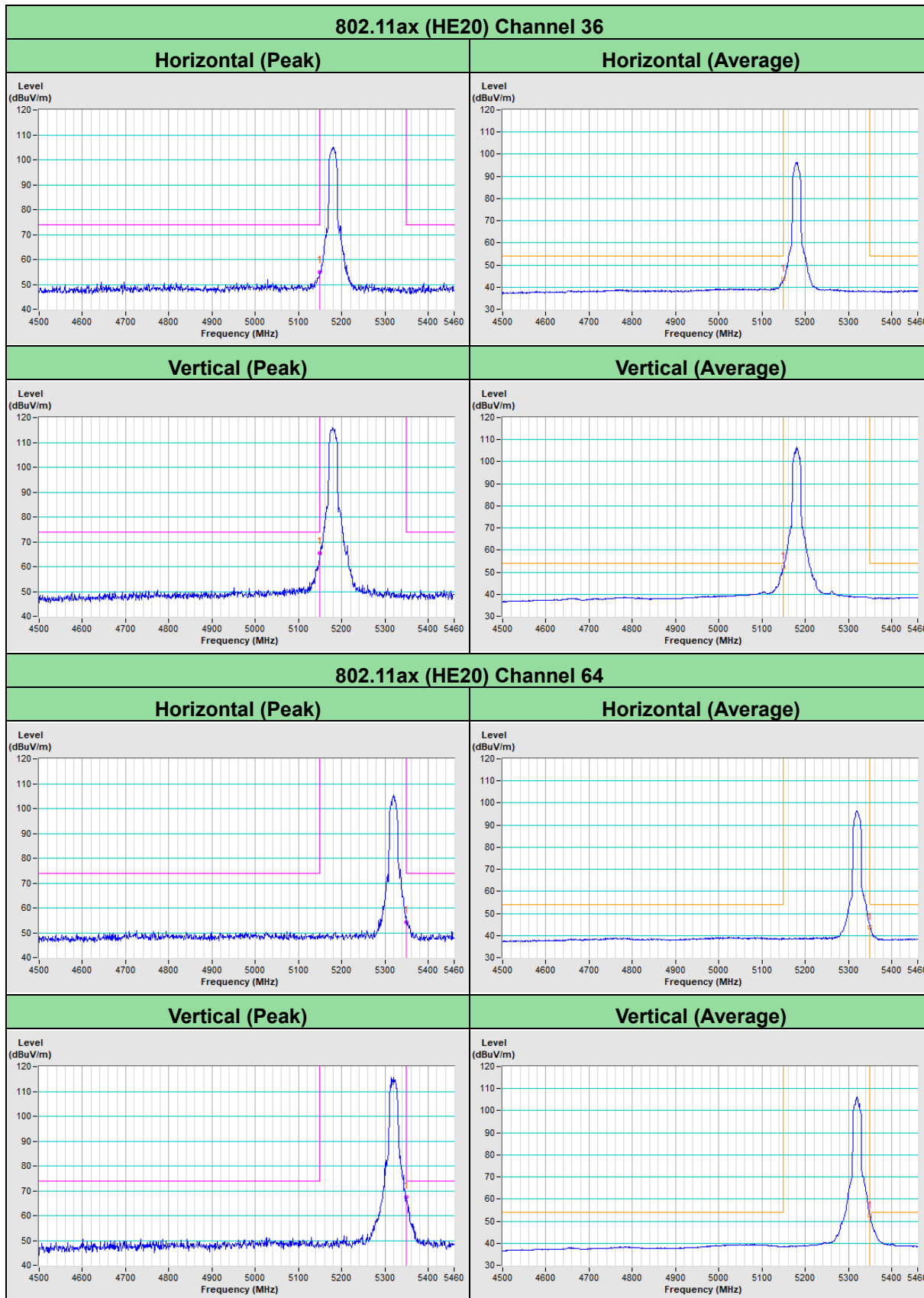

802.11ax (HE20) Channel 100

Horizontal (Peak)

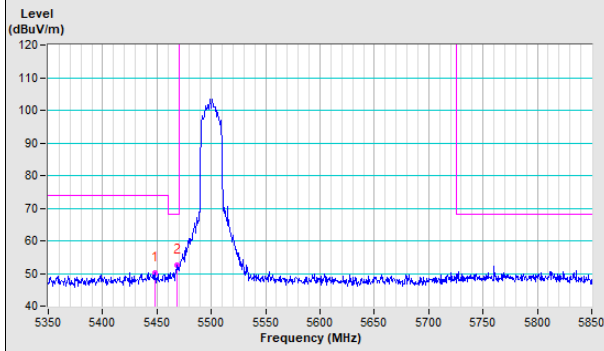

Horizontal (Average)

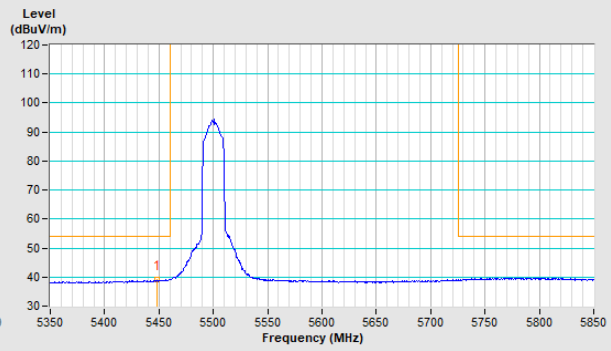

Vertical (Peak)

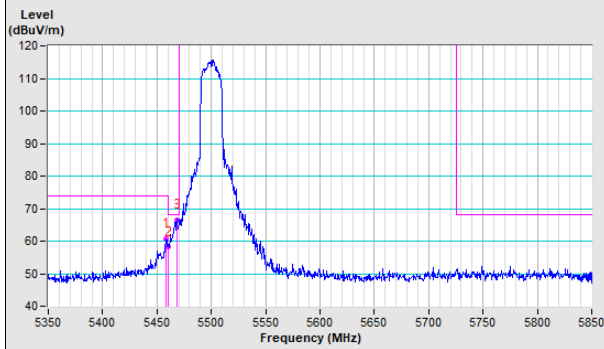

Vertical (Average)

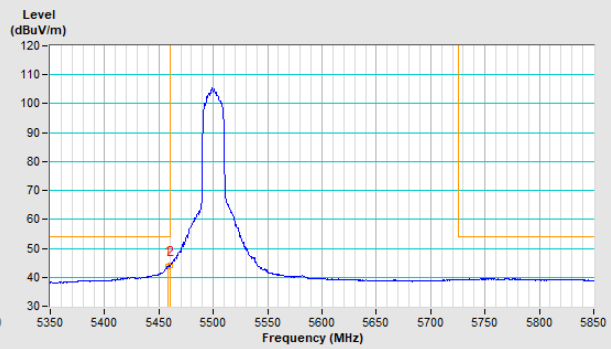

802.11ax (HE40) Channel 38

Horizontal (Peak)	Horizontal (Average)
-------------------	----------------------

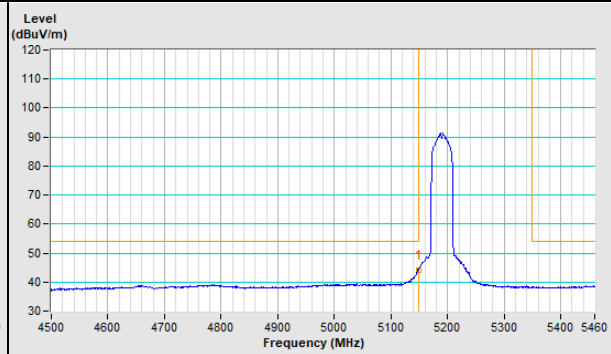
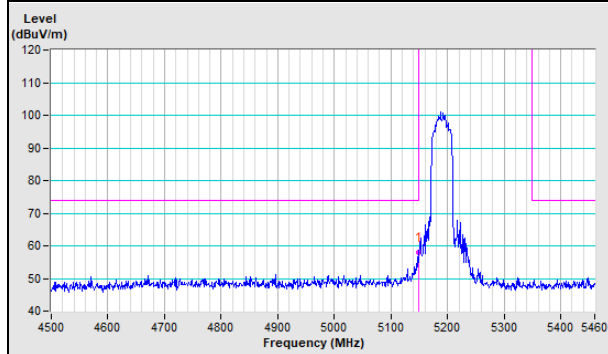

Vertical (Peak)	Vertical (Average)
-----------------	--------------------

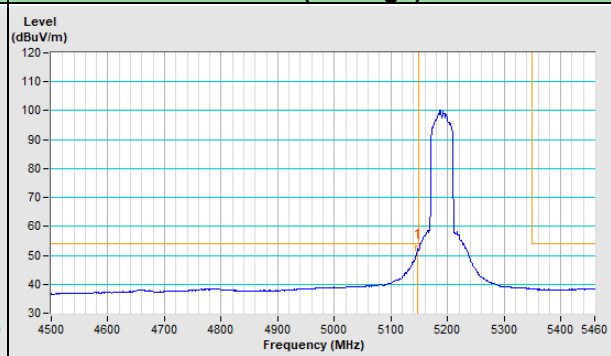
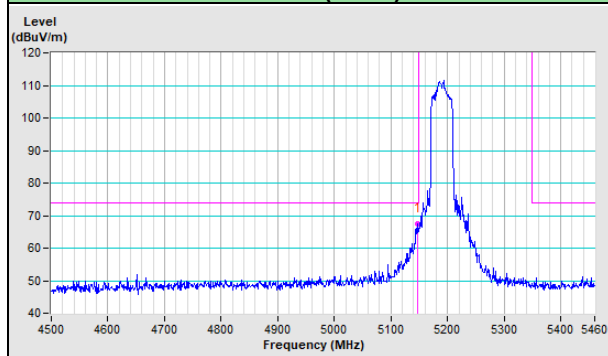

802.11ax (HE40) Channel 62

Horizontal (Peak)	Horizontal (Average)
-------------------	----------------------

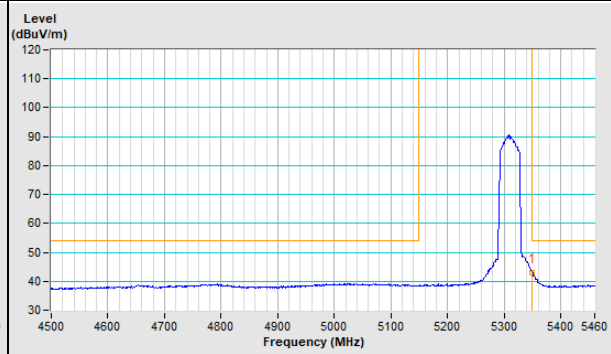
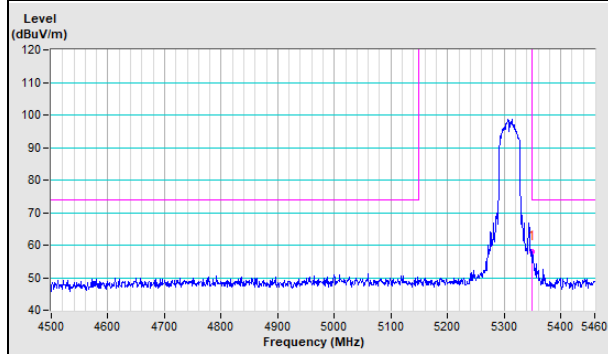

Vertical (Peak)	Vertical (Average)
-----------------	--------------------

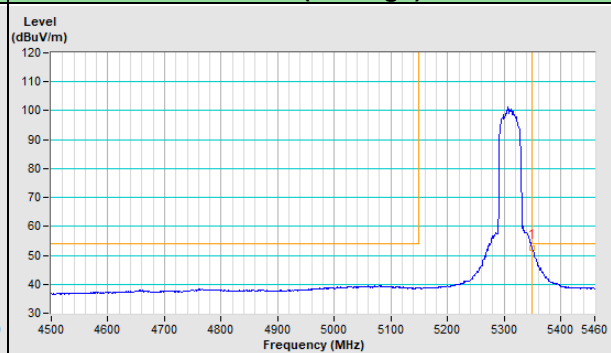
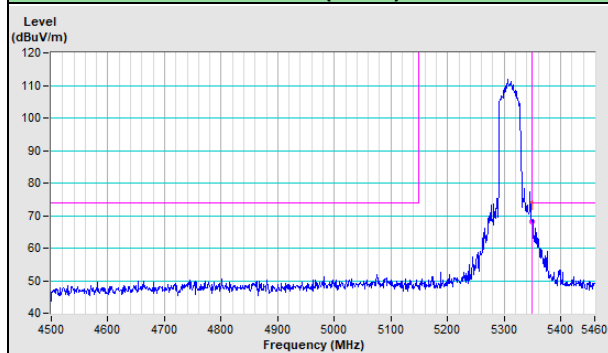

802.11ax (HE40) Channel 102

Horizontal (Peak)

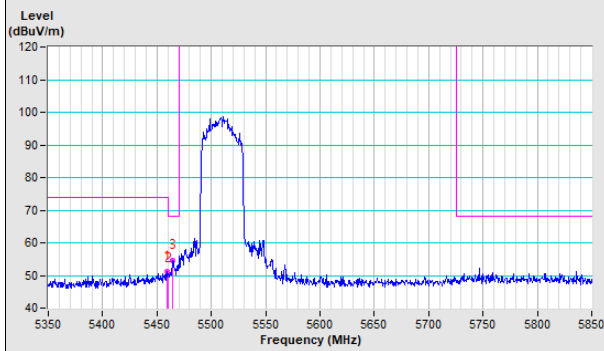

Horizontal (Average)

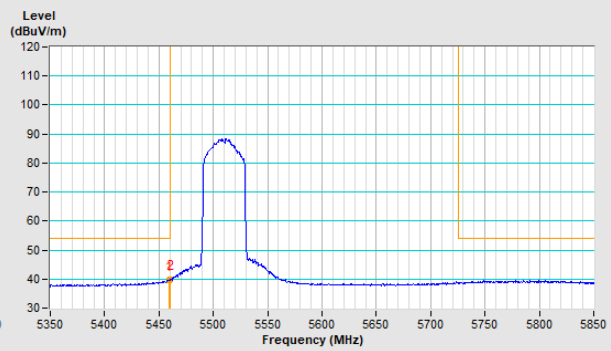

Vertical (Peak)

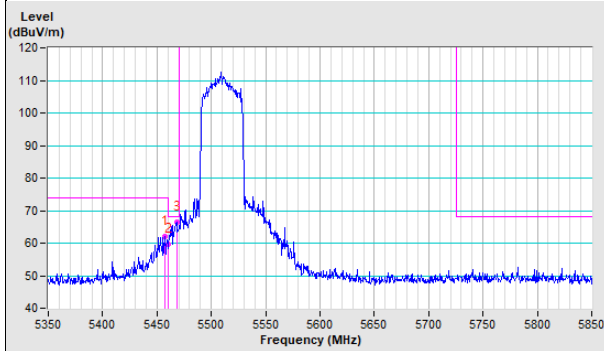

Vertical (Average)

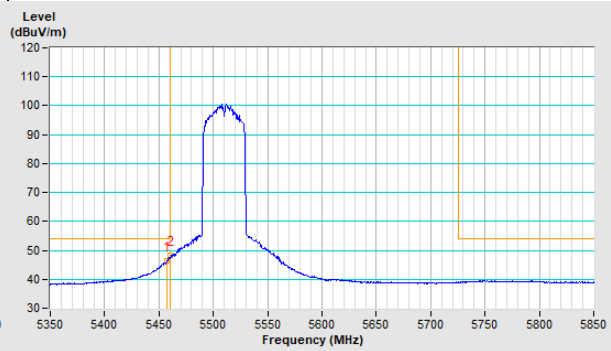

802.11ax (HE80) Channel 42

Horizontal (Peak)	Horizontal (Average)
--------------------------	-----------------------------

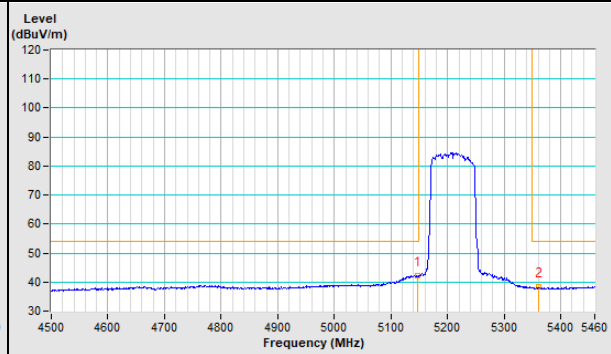
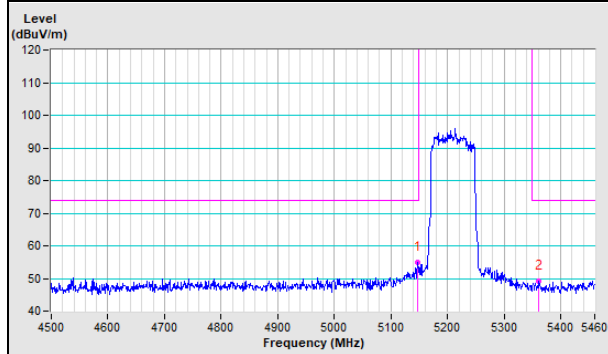

Vertical (Peak)	Vertical (Average)
------------------------	---------------------------

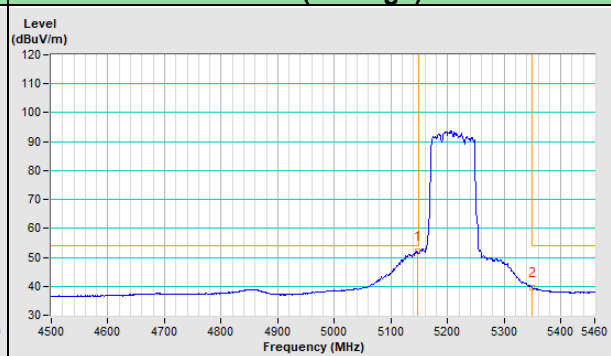
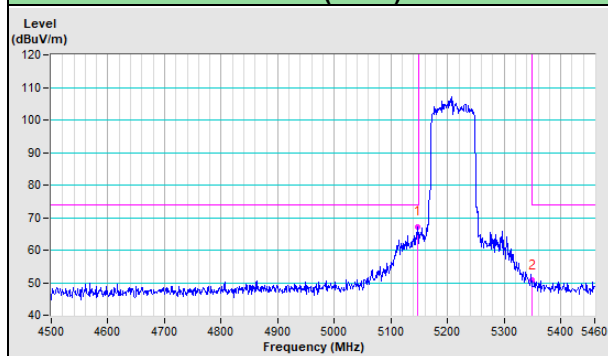

802.11ax (HE80) Channel 58

Horizontal (Peak)	Horizontal (Average)
--------------------------	-----------------------------

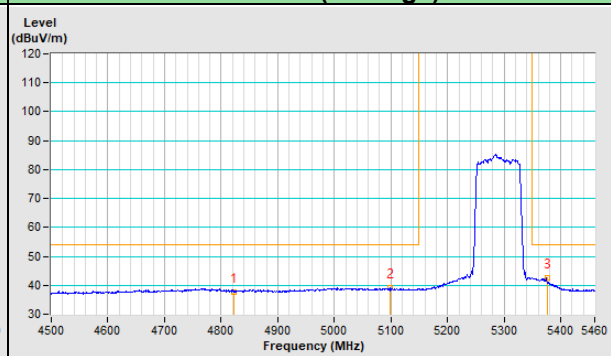
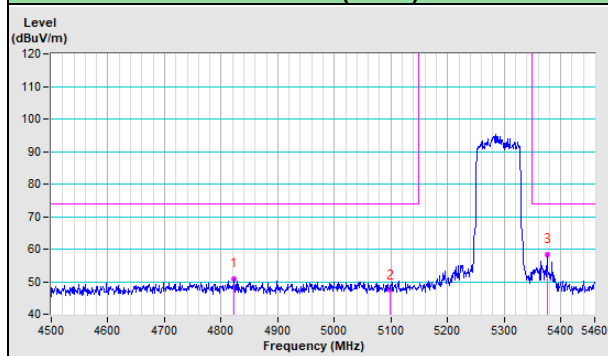

Vertical (Peak)	Vertical (Average)
------------------------	---------------------------

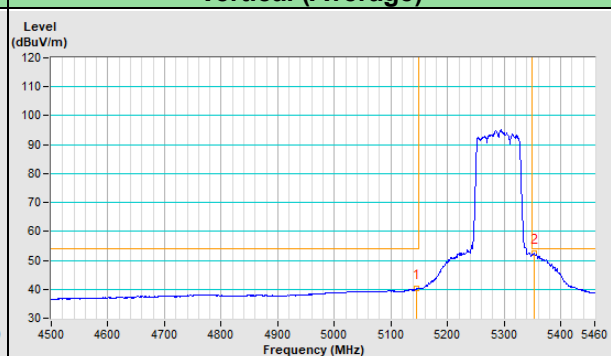
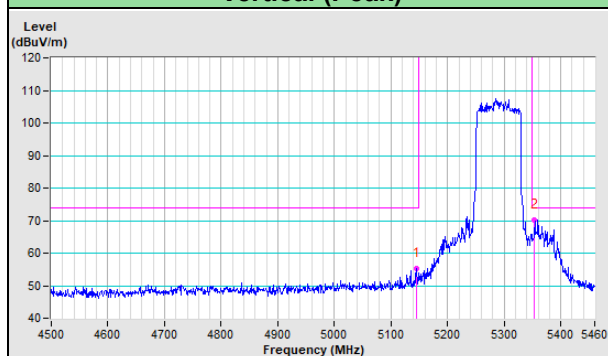

802.11ax (HE80) Channel 106

Horizontal (Peak)

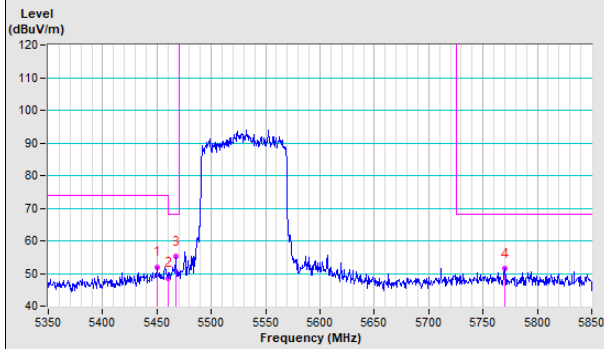

Horizontal (Average)

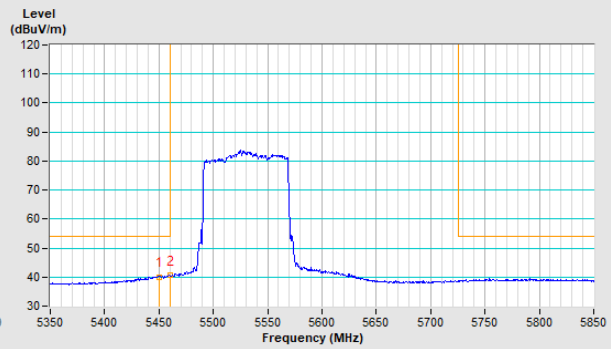

Vertical (Peak)

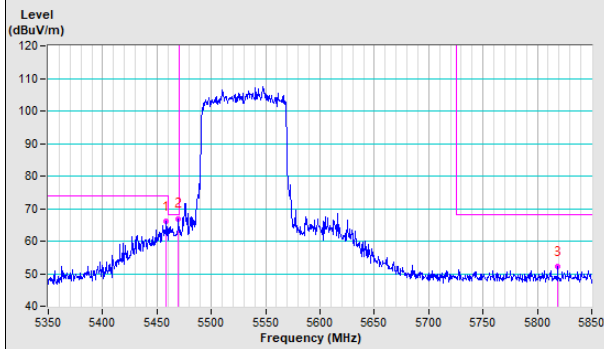

Vertical (Average)

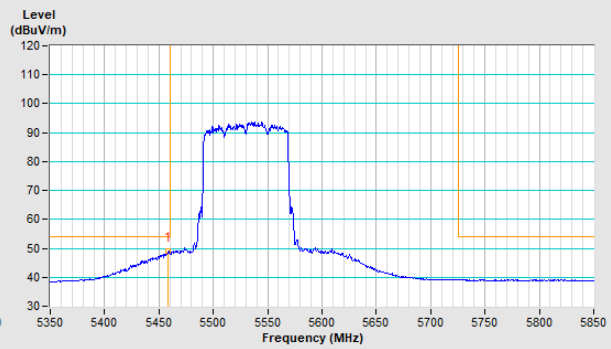

20MHz Preamble 802.11ax (RU26) Channel 36

Horizontal (Peak)

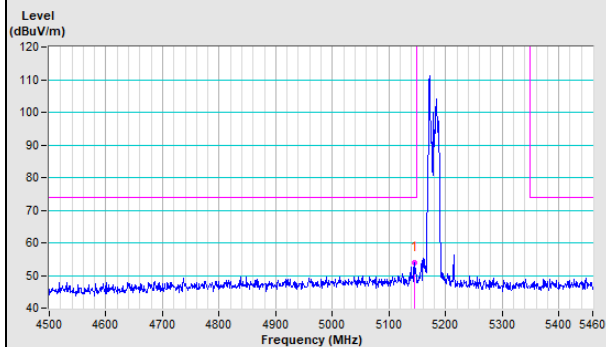

Horizontal (Average)

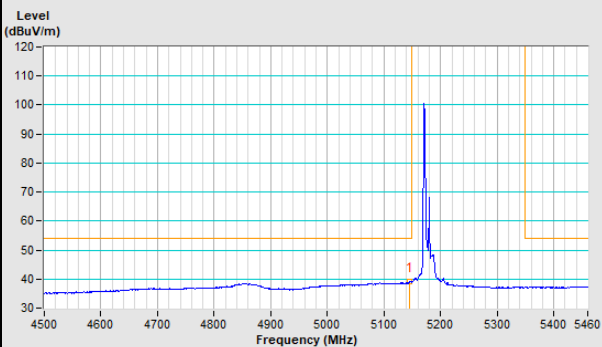

Vertical (Peak)

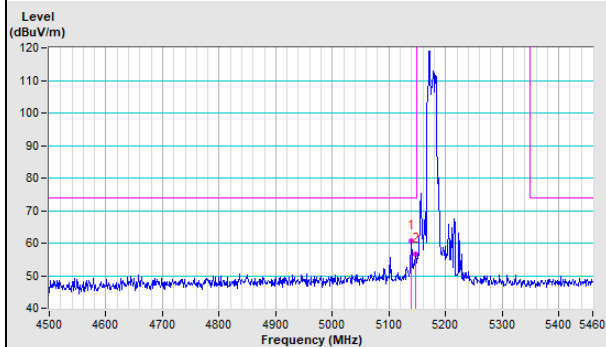

Vertical (Average)

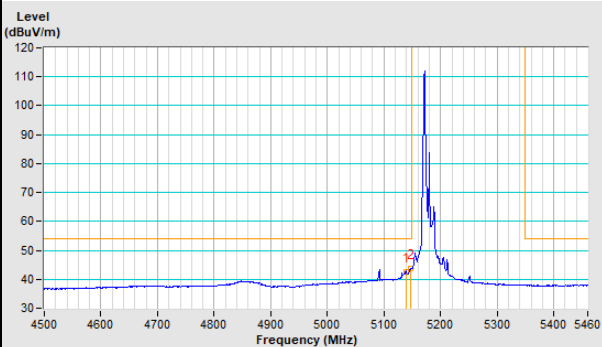

20MHz Preamble 802.11ax (RU26) Channel 64

Horizontal (Peak)

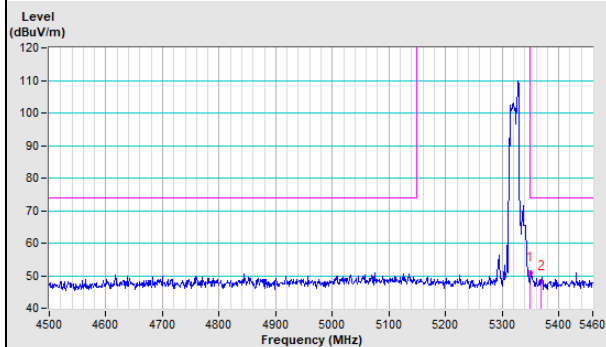

Horizontal (Average)

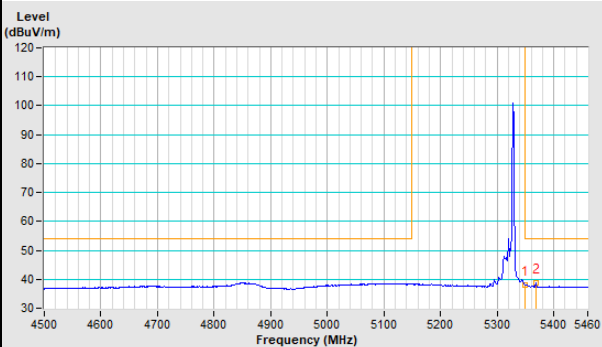

Vertical (Peak)

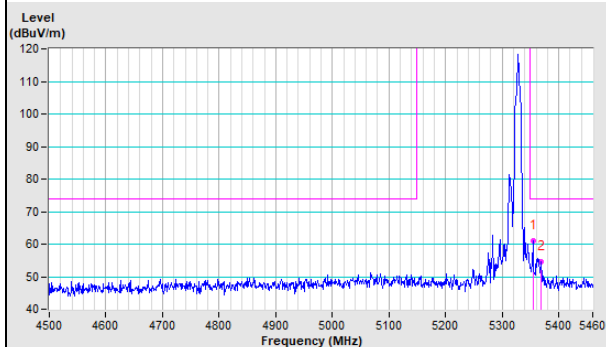

Vertical (Average)

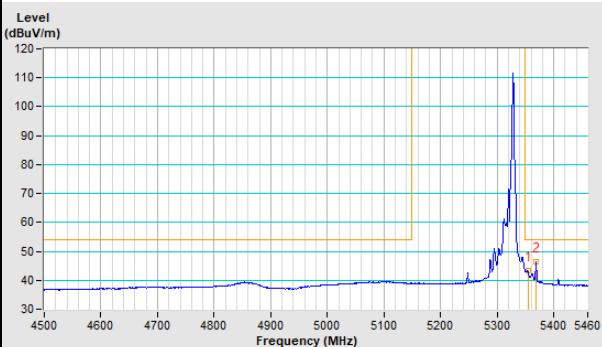

20MHz Preamble 802.11ax (RU26) Channel 100

Horizontal (Peak)

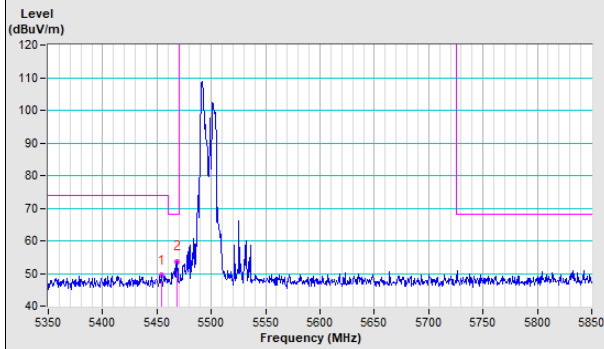

Horizontal (Average)

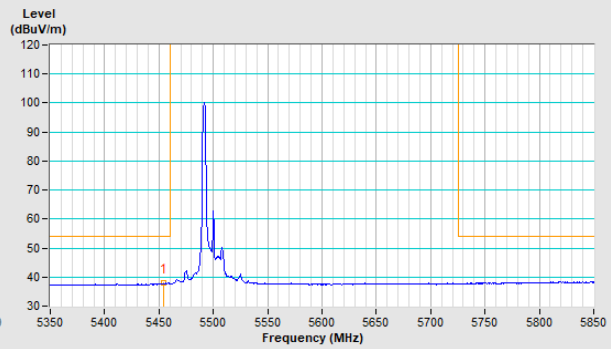

Vertical (Peak)

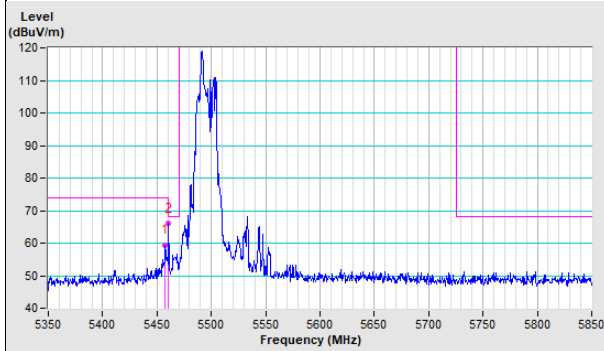

Vertical (Average)

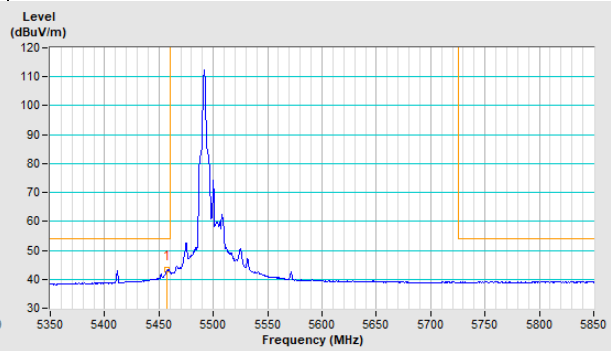

20MHz Preamble 802.11ax (RU52) Channel 36

Horizontal (Peak)

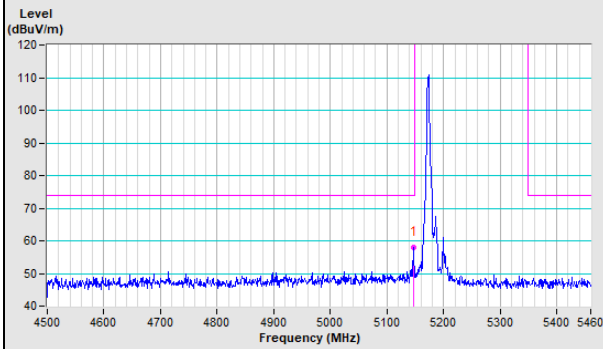

Horizontal (Average)

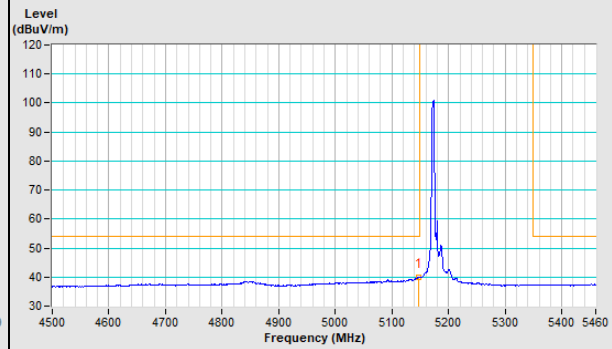

Vertical (Peak)

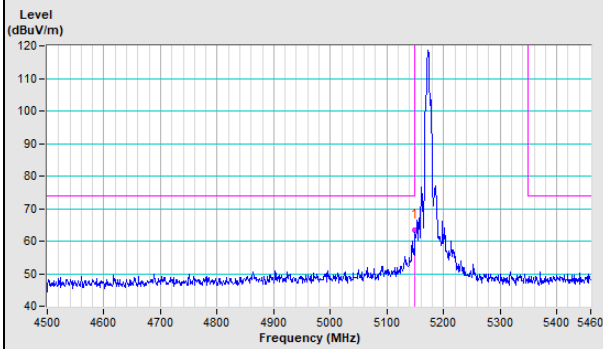

Vertical (Average)

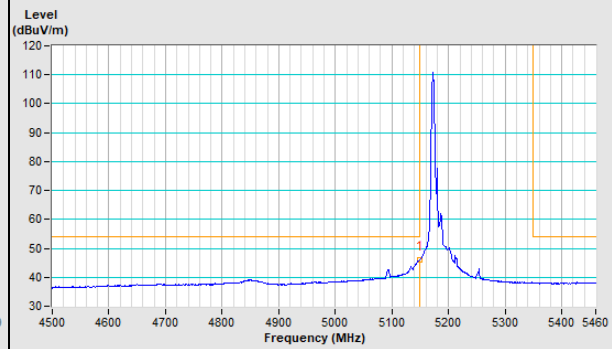

20MHz Preamble 802.11ax (RU52) Channel 64

Horizontal (Peak)

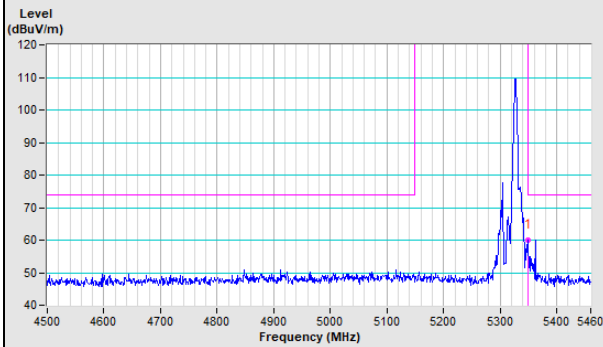

Horizontal (Average)

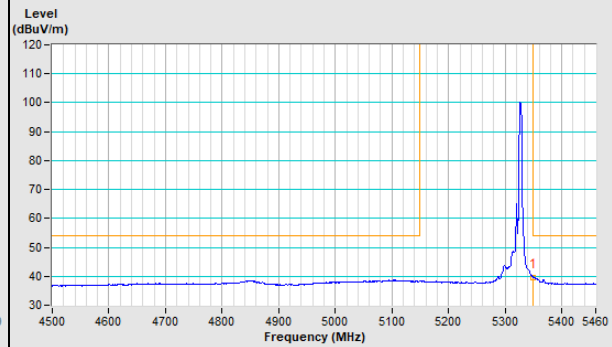

Vertical (Peak)

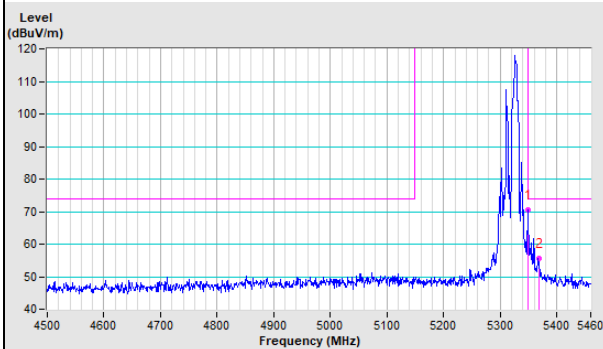

Vertical (Average)

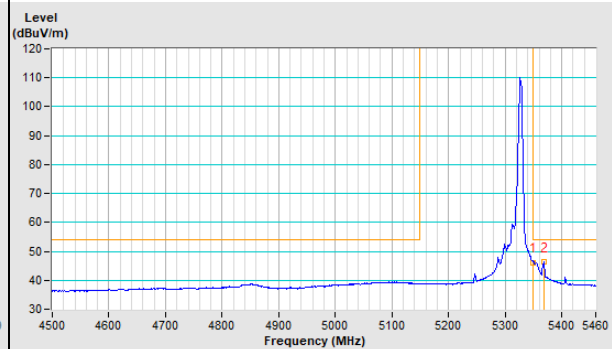

20MHz Preamble 802.11ax (RU52) Channel 100

Horizontal (Peak)

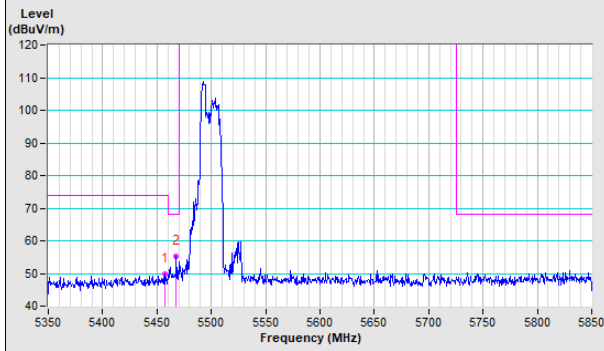

Horizontal (Average)

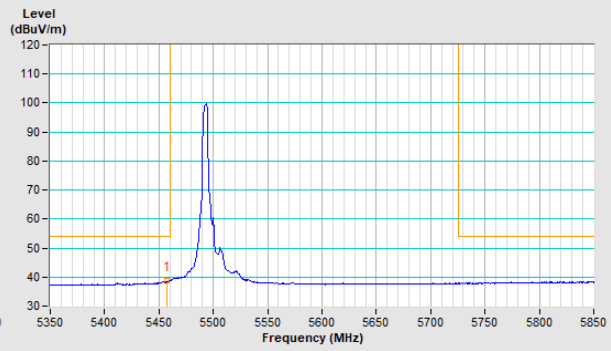

Vertical (Peak)

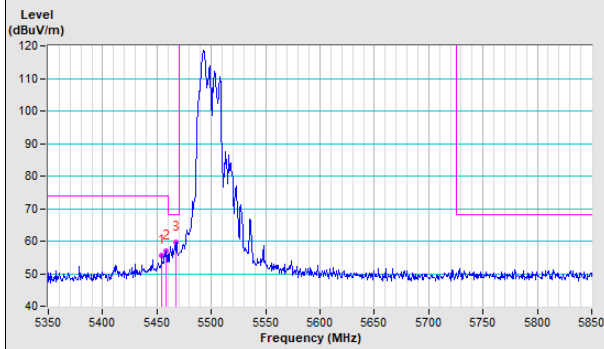

Vertical (Average)

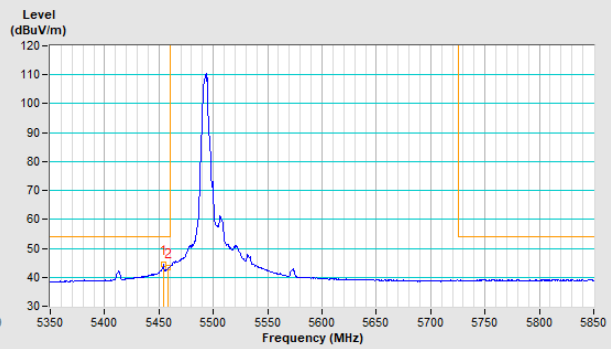

20MHz Preamble 802.11ax (RU106) Channel 36

Horizontal (Peak)

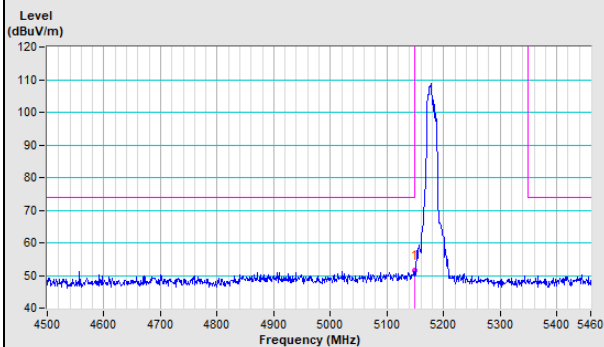

Horizontal (Average)

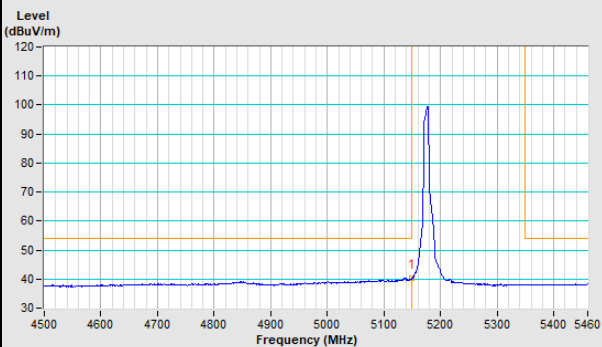

Vertical (Peak)

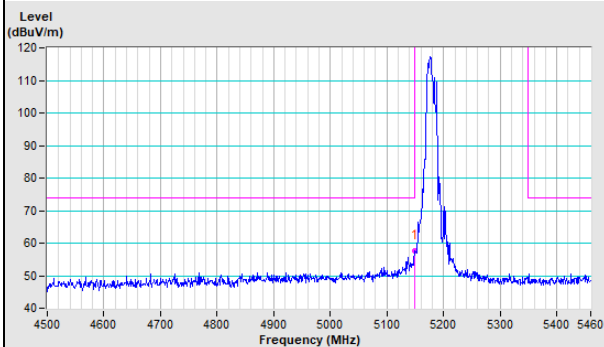

Vertical (Average)

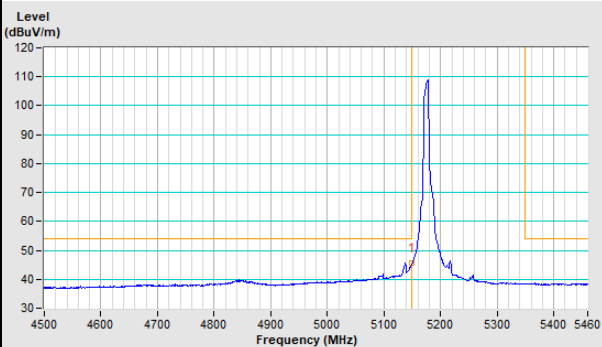

20MHz Preamble 802.11ax (RU106) Channel 64

Horizontal (Peak)

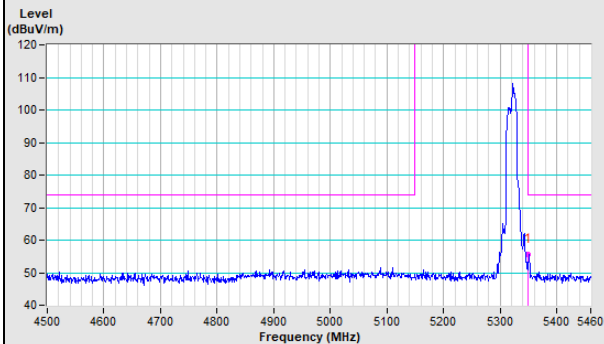

Horizontal (Average)

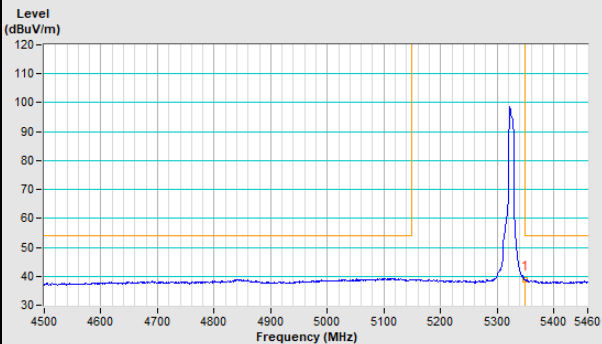

Vertical (Peak)

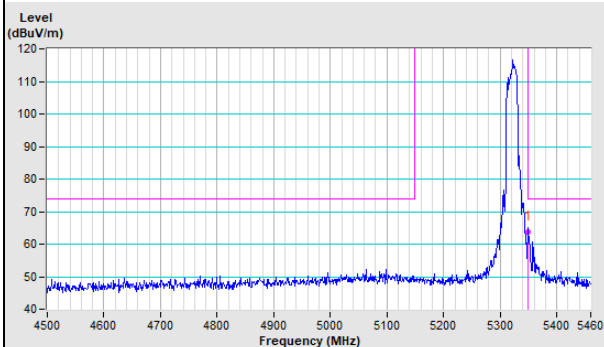

Vertical (Average)

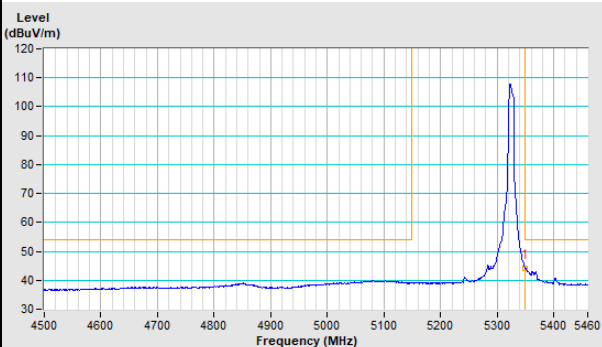

20MHz Preamble 802.11ax (RU106) Channel 100

Horizontal (Peak)

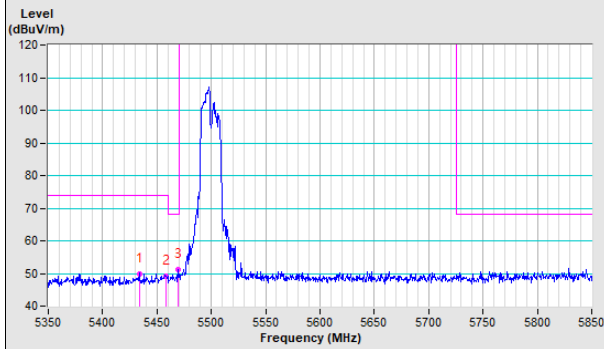

Horizontal (Average)

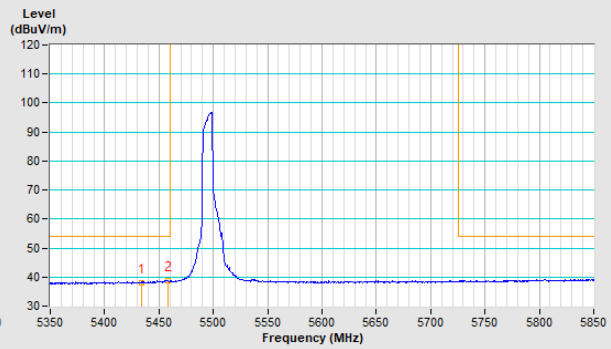

Vertical (Peak)

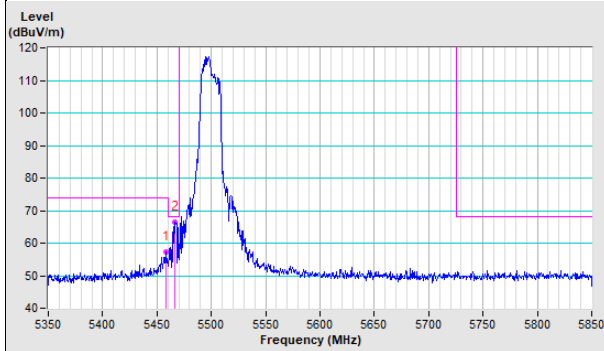

Vertical (Average)

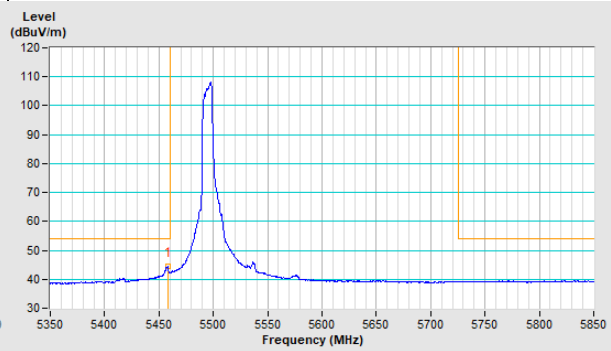

PIFA Antenna

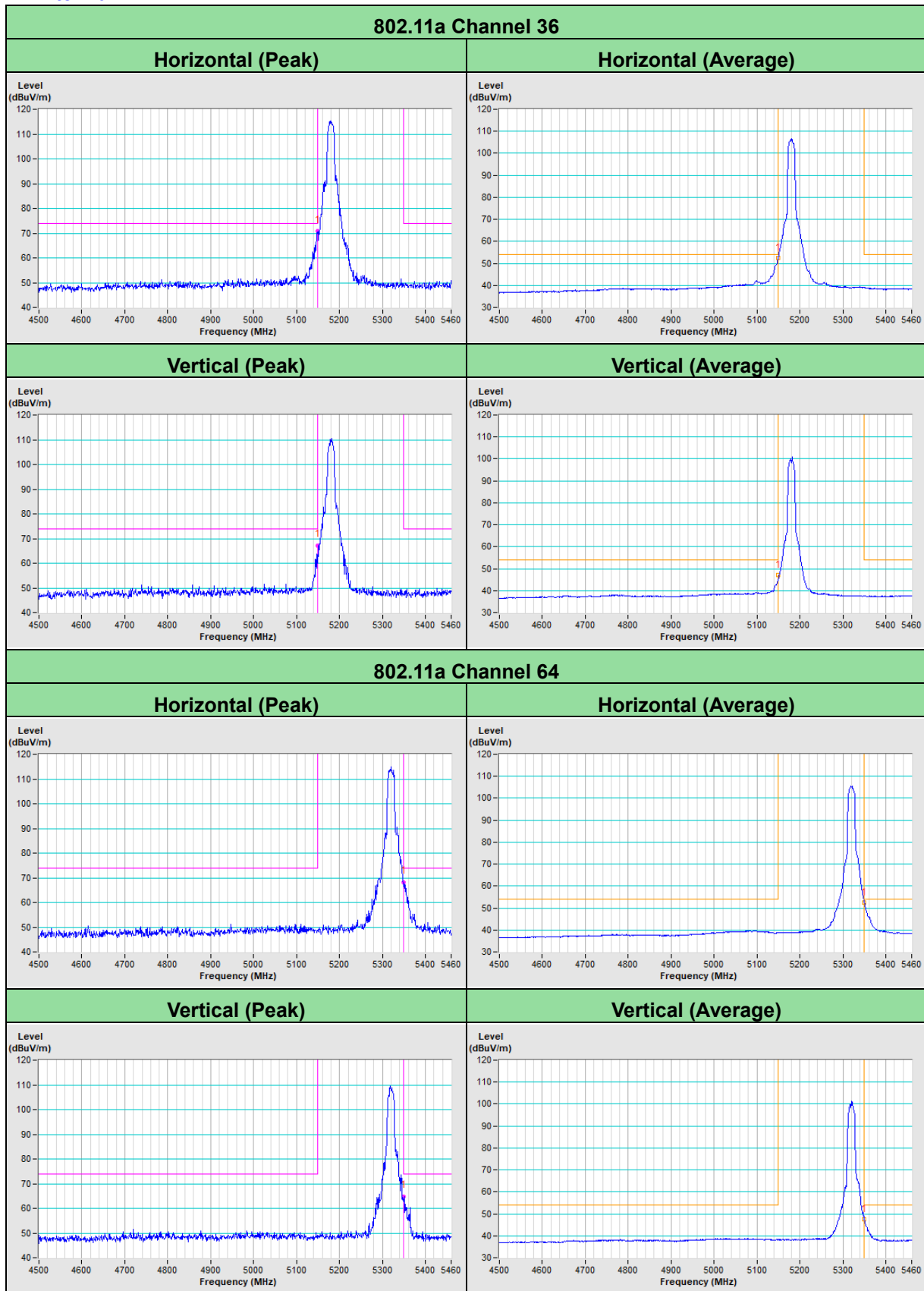

802.11a Channel 100

Horizontal (Peak)

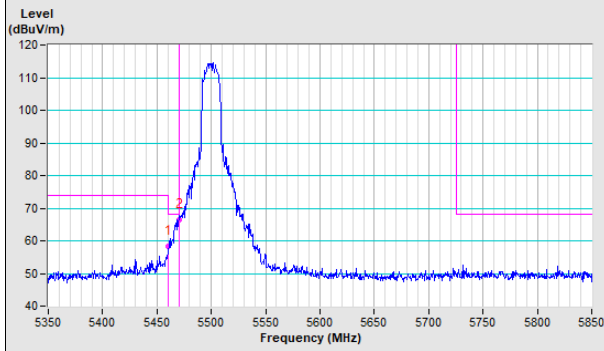

Horizontal (Average)

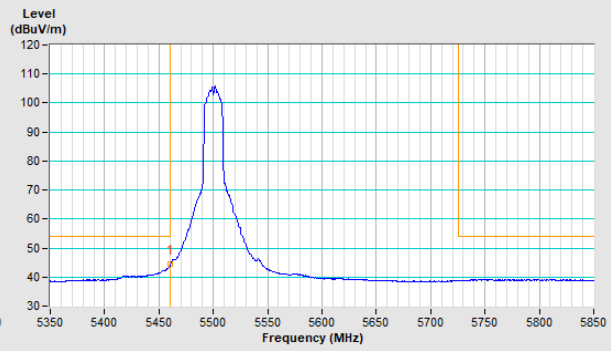

Vertical (Peak)

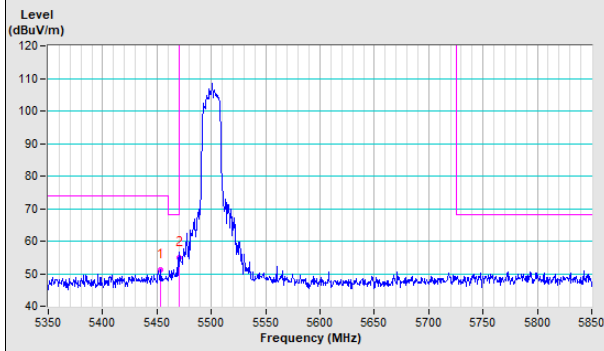

Vertical (Average)

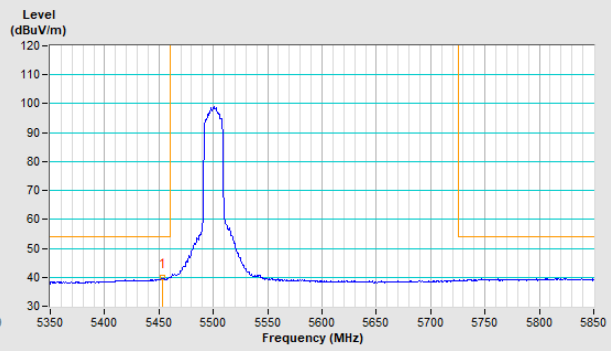

802.11ax (HE20) Channel 36

Horizontal (Peak)	Horizontal (Average)
--------------------------	-----------------------------

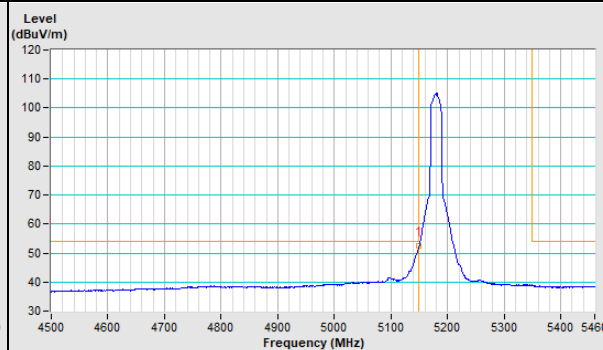
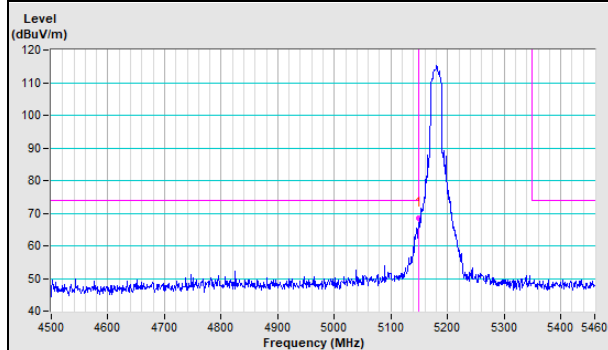

Vertical (Peak)	Vertical (Average)
------------------------	---------------------------

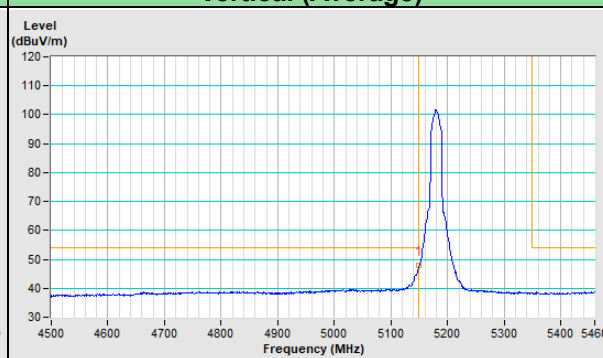
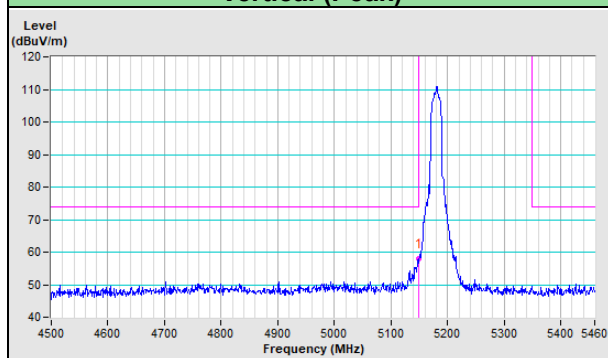

802.11ax (HE20) Channel 64

Horizontal (Peak)	Horizontal (Average)
--------------------------	-----------------------------

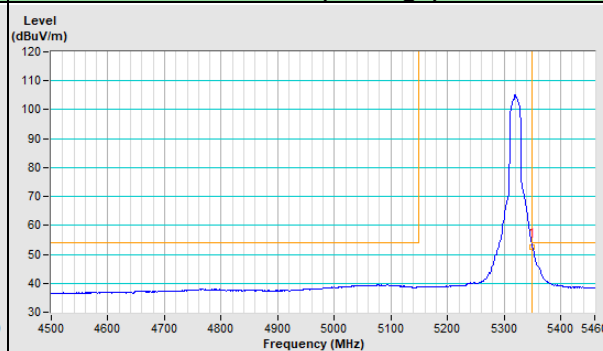
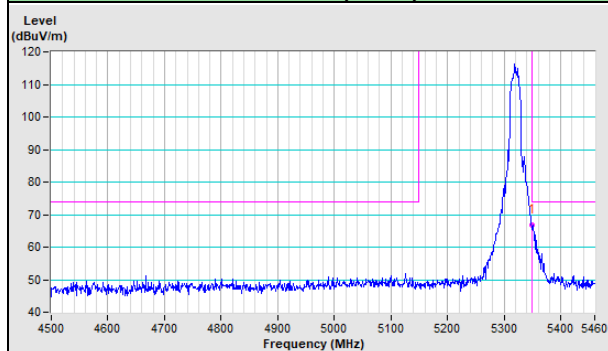

Vertical (Peak)	Vertical (Average)
------------------------	---------------------------

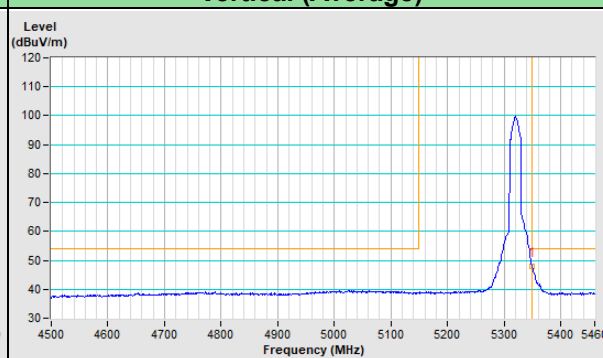
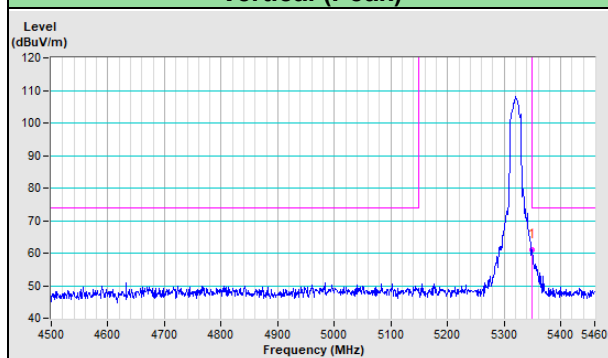

802.11ax (HE20) Channel 100

Horizontal (Peak)

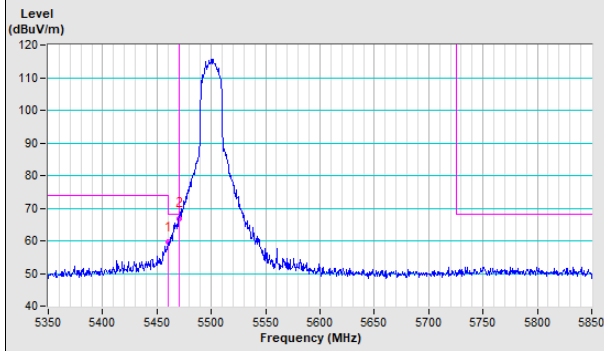

Horizontal (Average)

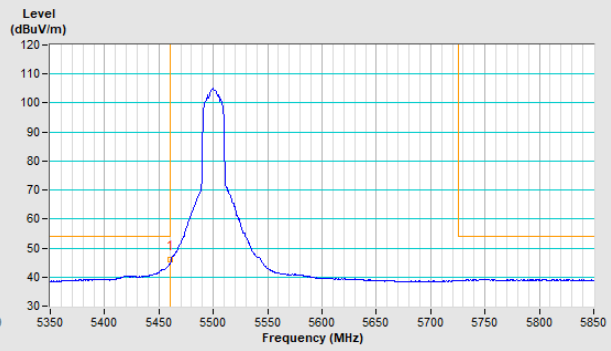

Vertical (Peak)

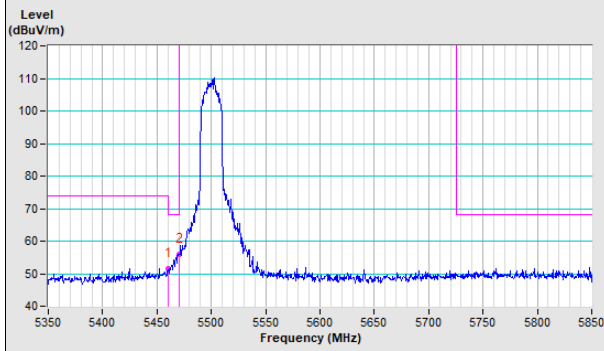

Vertical (Average)

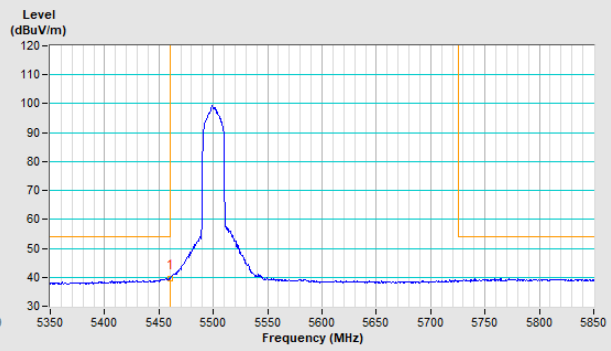

802.11ax (HE40) Channel 38

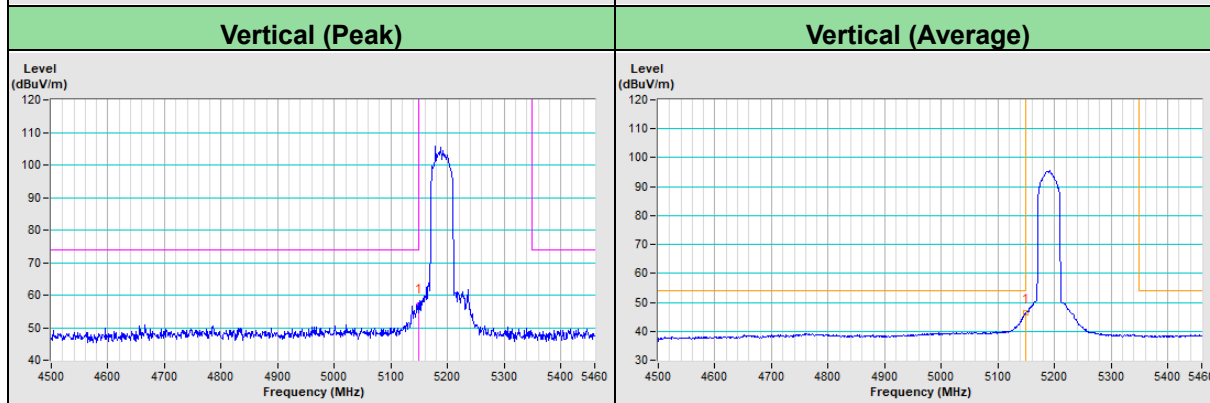
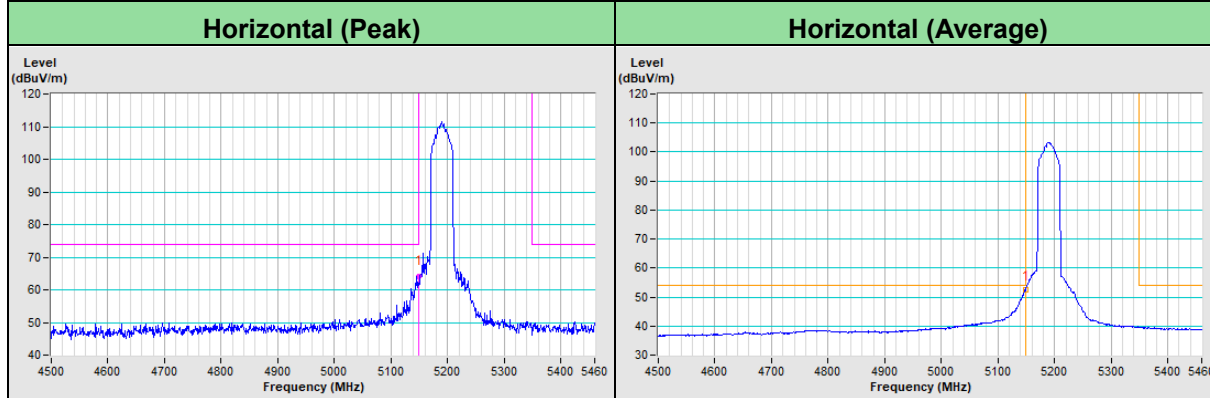

802.11ax (HE40) Channel 62

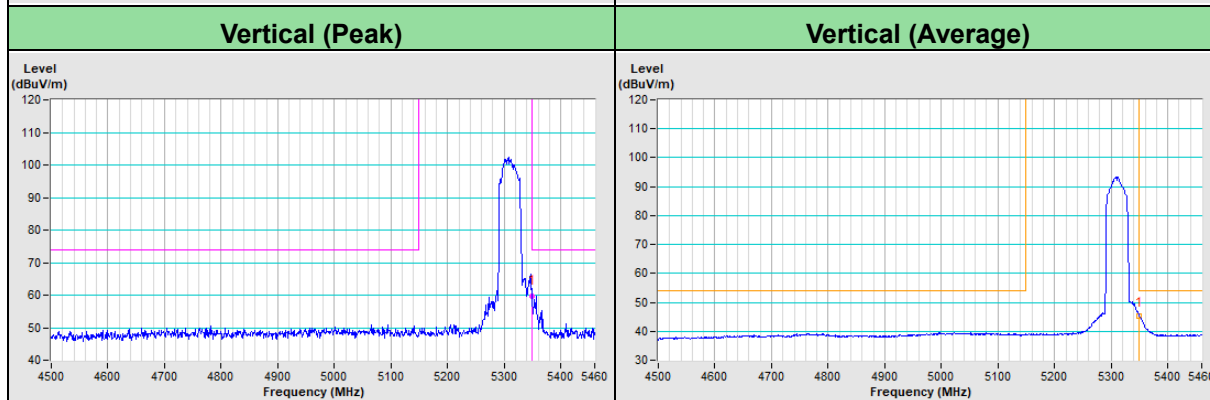
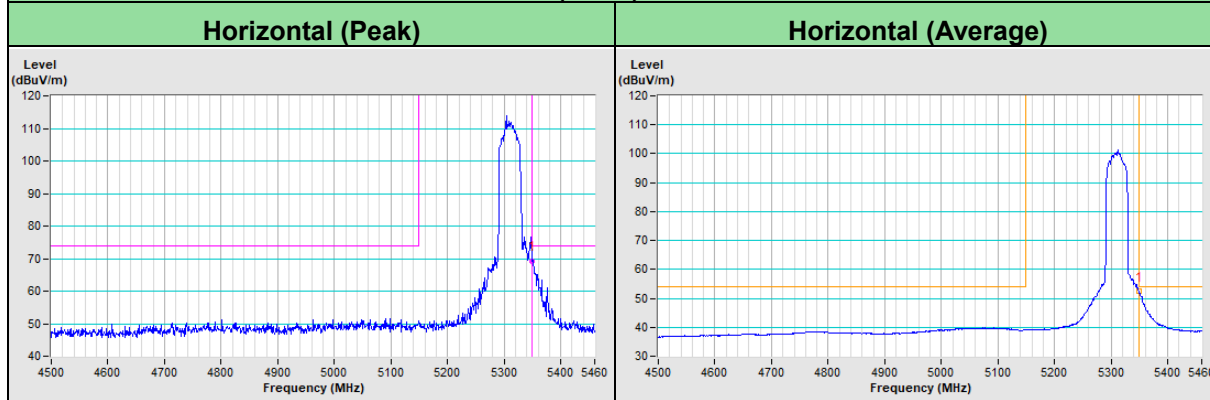

802.11ax (HE40) Channel 102

Horizontal (Peak)

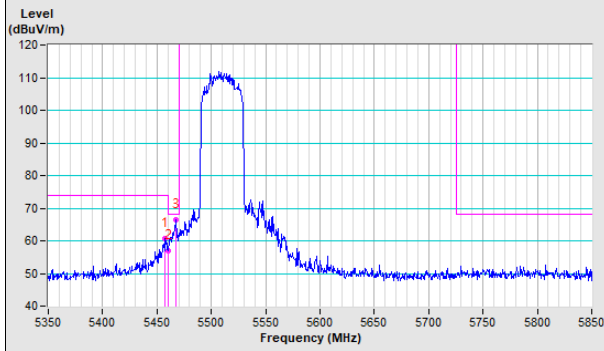

Horizontal (Average)

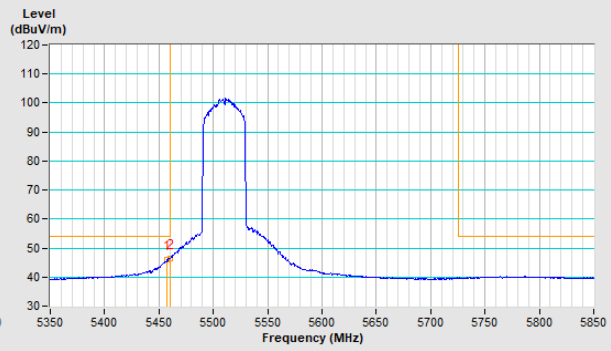

Vertical (Peak)

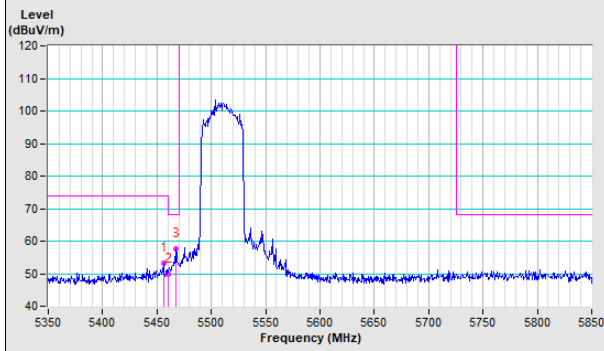

Vertical (Average)

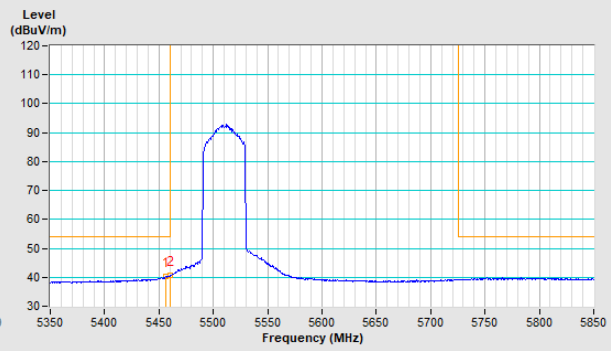

802.11ax (HE80) Channel 42

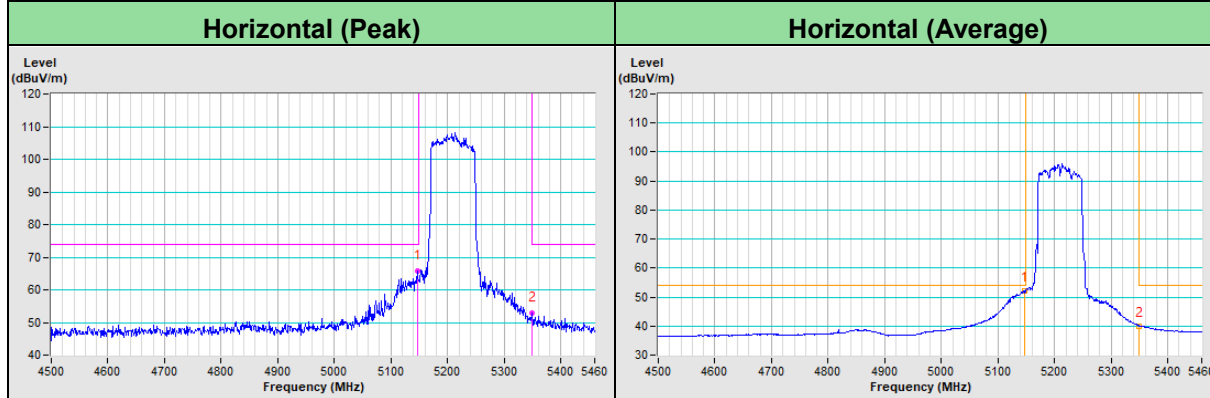

Vertical (Peak)	Vertical (Average)
-----------------	--------------------

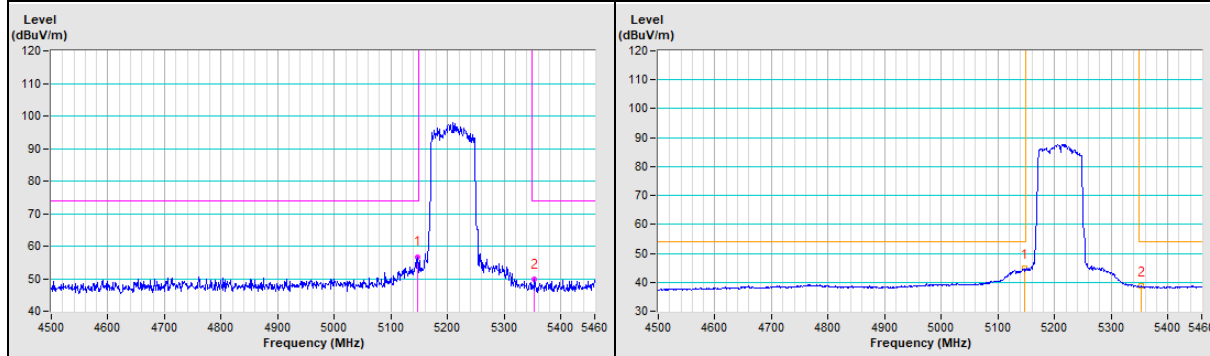

802.11ax (HE80) Channel 58

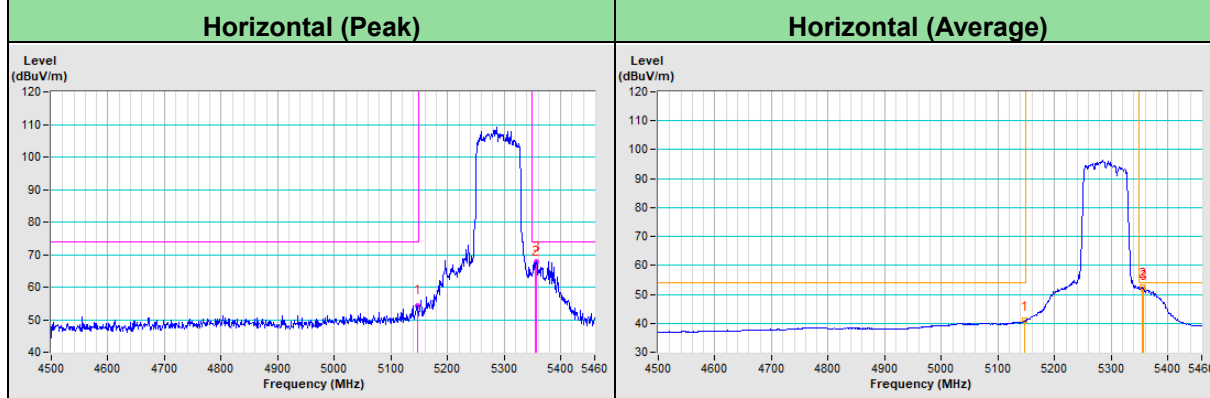

Vertical (Peak)	Vertical (Average)
-----------------	--------------------

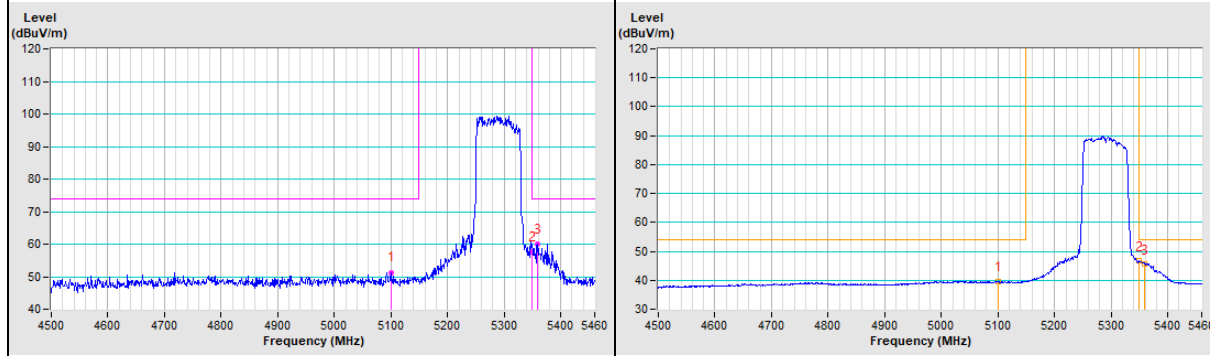

802.11ax (HE80) Channel 106

Horizontal (Peak)

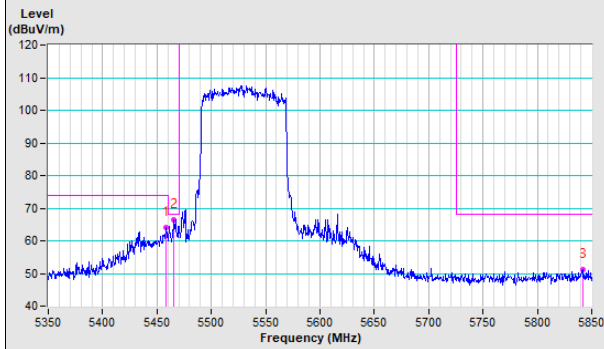

Horizontal (Average)

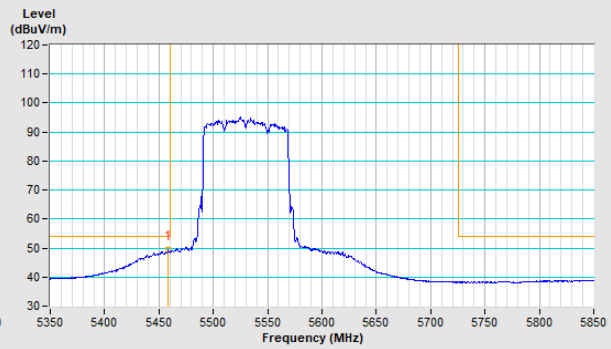

Vertical (Peak)

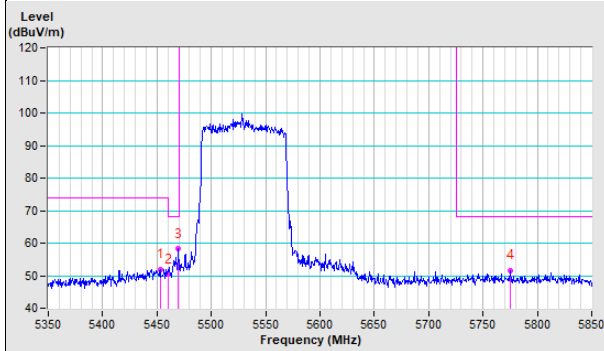

Vertical (Average)

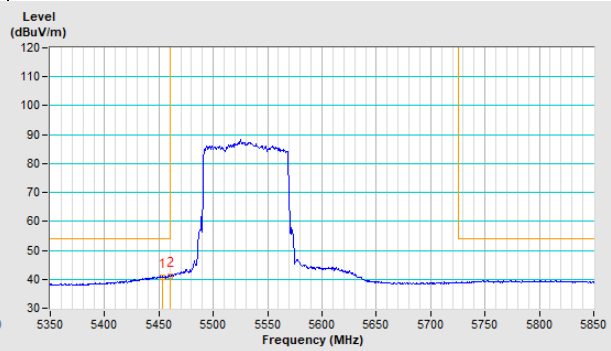

20MHz Preamble 802.11ax (RU26) Channel 36

Horizontal (Peak)	Horizontal (Average)
-------------------	----------------------

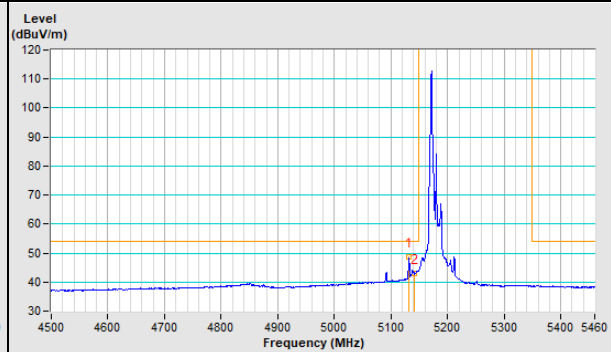
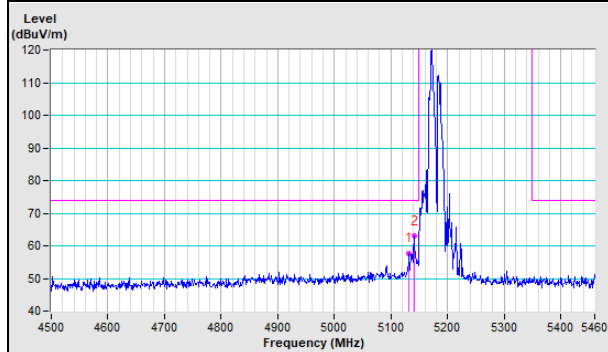

Vertical (Peak)	Vertical (Average)
-----------------	--------------------

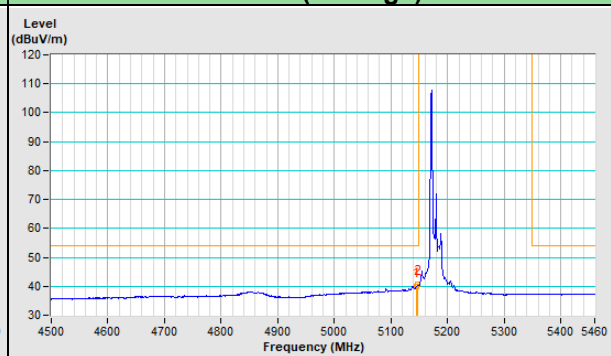
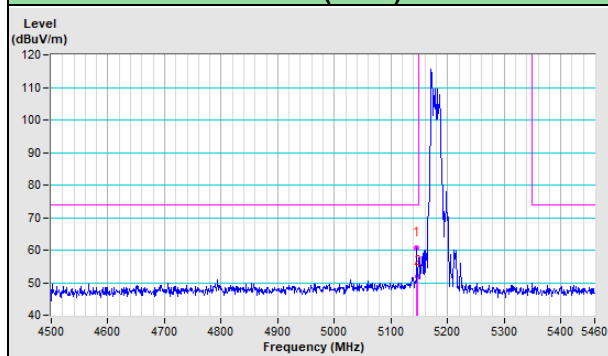

20MHz Preamble 802.11ax (RU26) Channel 64

Horizontal (Peak)	Horizontal (Average)
-------------------	----------------------

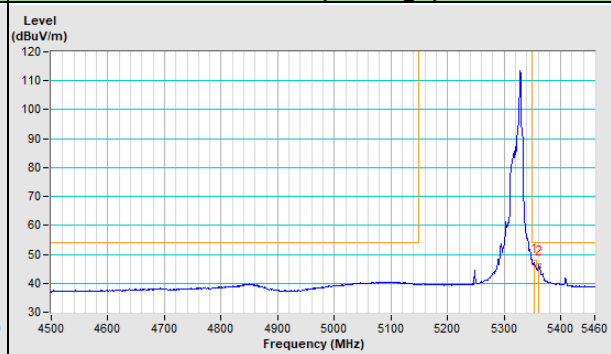
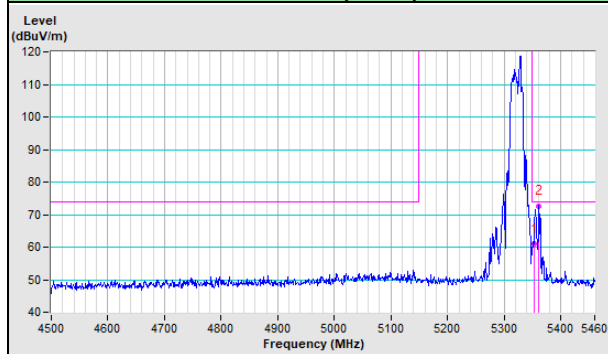

Vertical (Peak)	Vertical (Average)
-----------------	--------------------

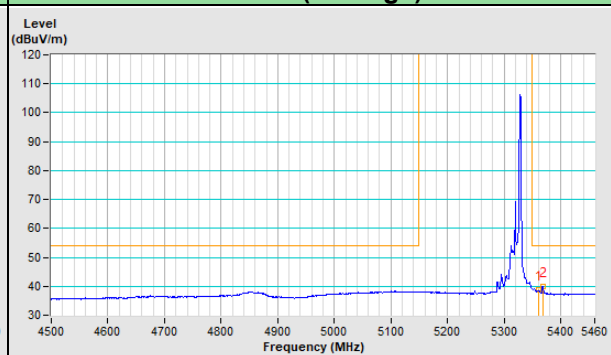
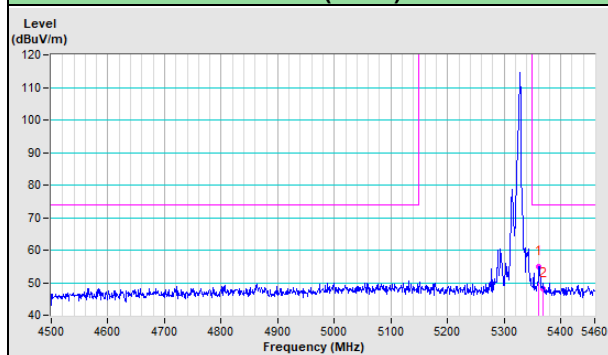

20MHz Preamble 802.11ax (RU26) Channel 100

Horizontal (Peak)

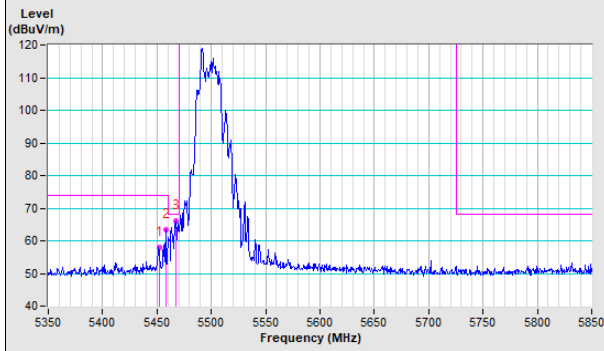

Horizontal (Average)

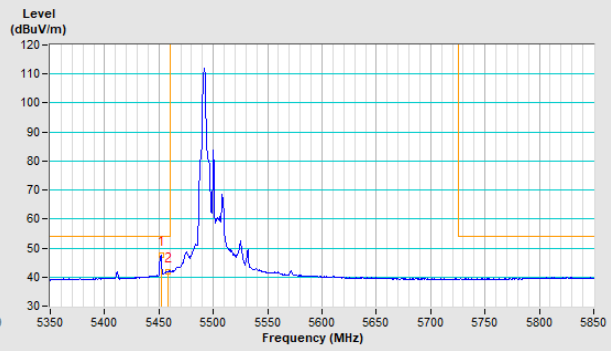

Vertical (Peak)

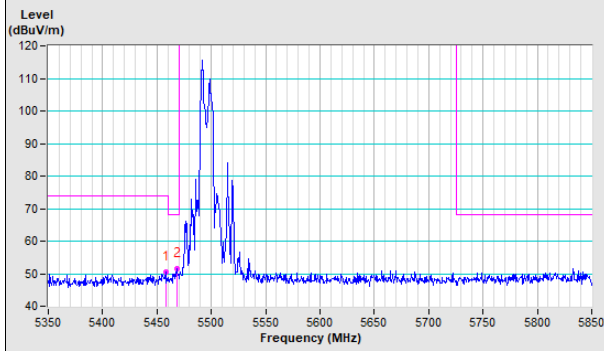

Vertical (Average)

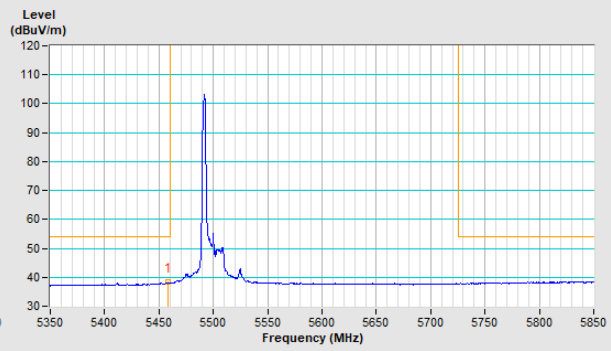

20MHz Preamble 802.11ax (RU52) Channel 36

Horizontal (Peak)

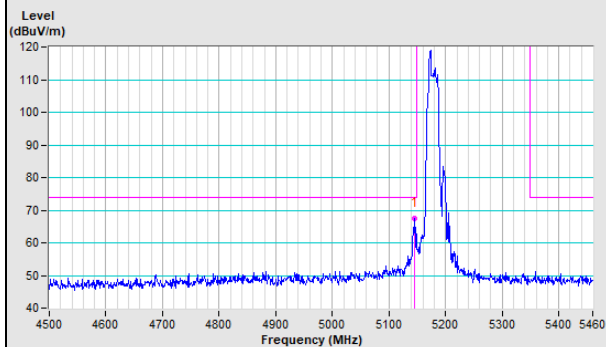

Horizontal (Average)

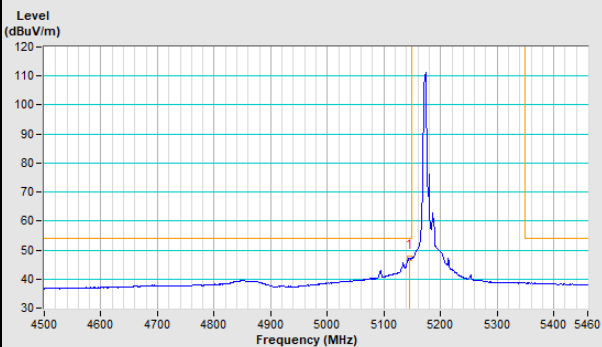

Vertical (Peak)

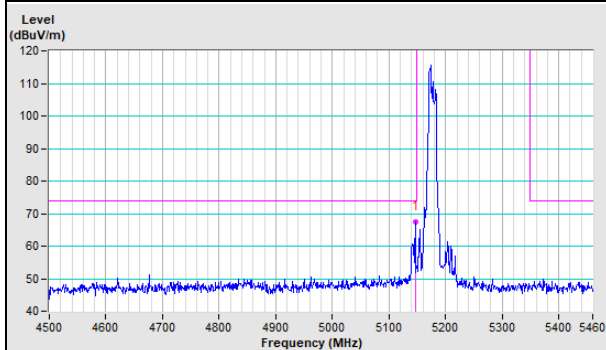

Vertical (Average)

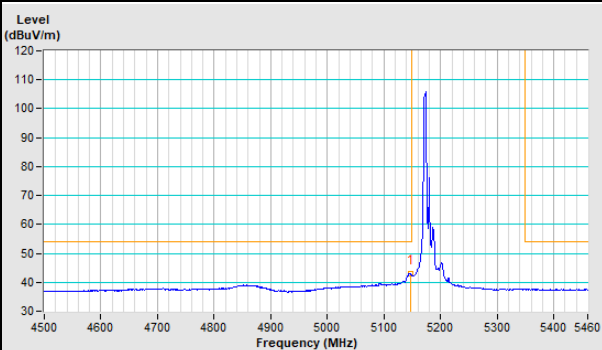

20MHz Preamble 802.11ax (RU52) Channel 64

Horizontal (Peak)

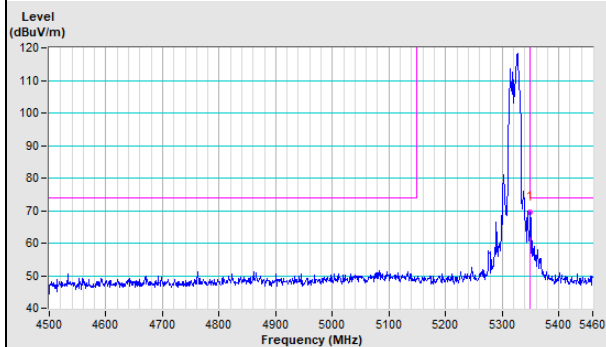

Horizontal (Average)

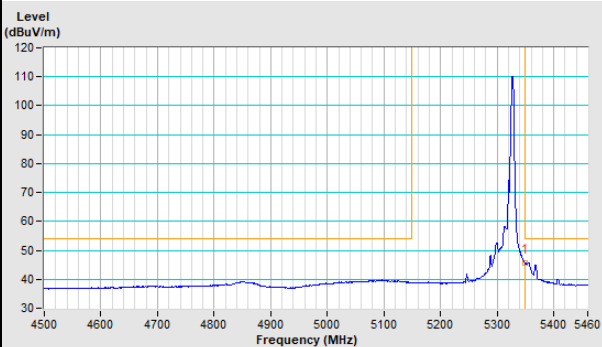

Vertical (Peak)

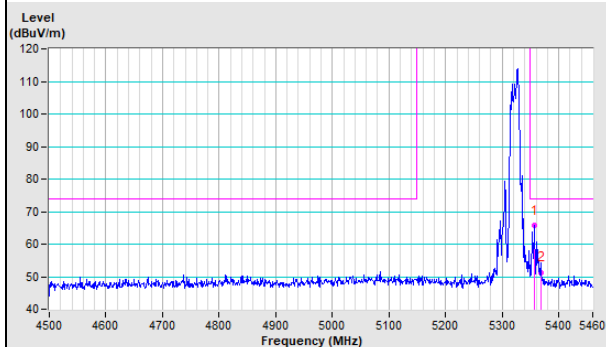

Vertical (Average)

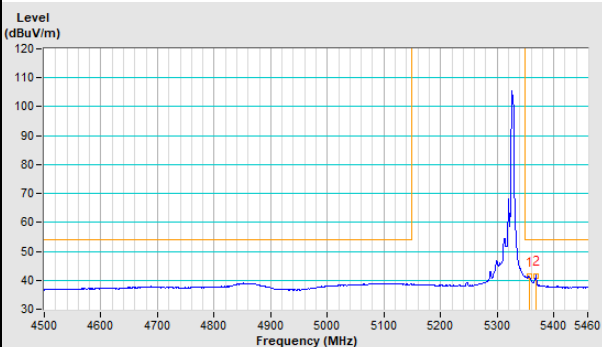

20MHz Preamble 802.11ax (RU52) Channel 100

Horizontal (Peak)

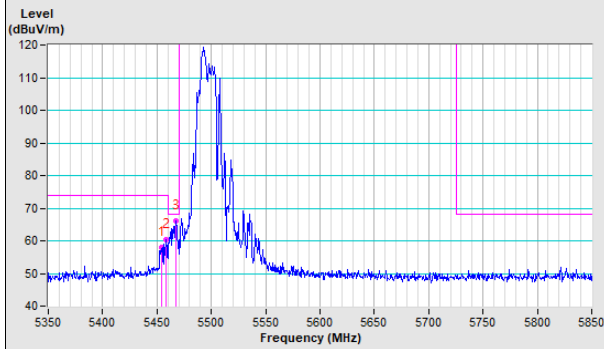

Horizontal (Average)

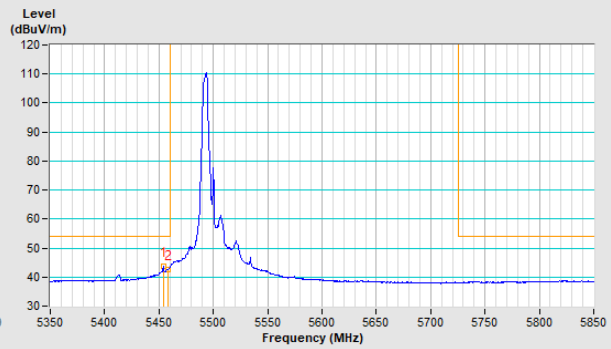

Vertical (Peak)

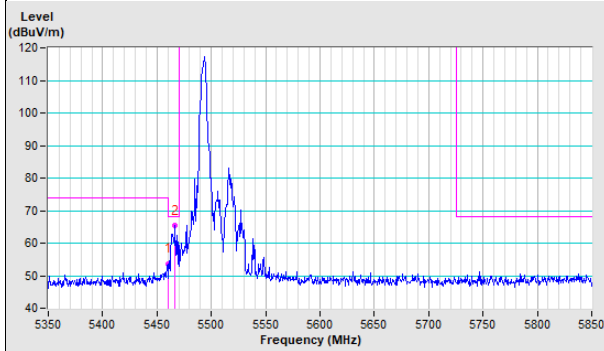

Vertical (Average)

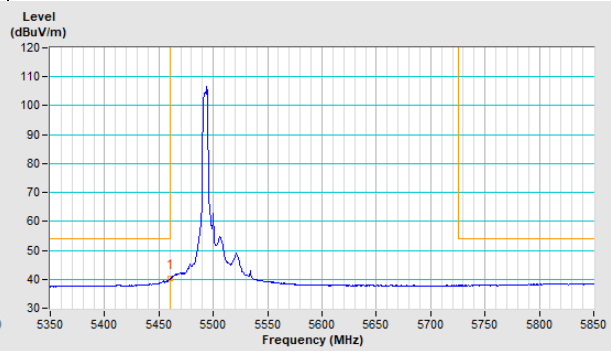

20MHz Preamble 802.11ax (RU106) Channel 36

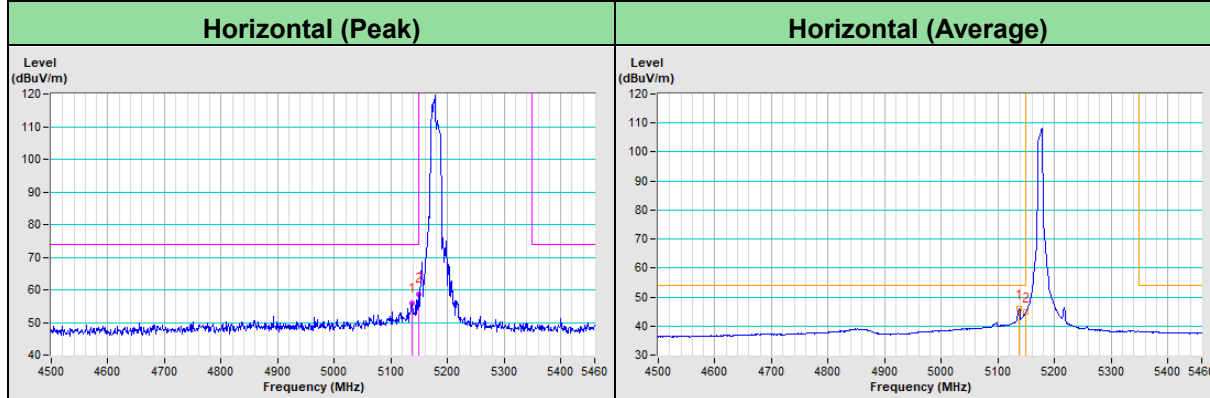

Vertical (Peak)	Vertical (Average)
-----------------	--------------------

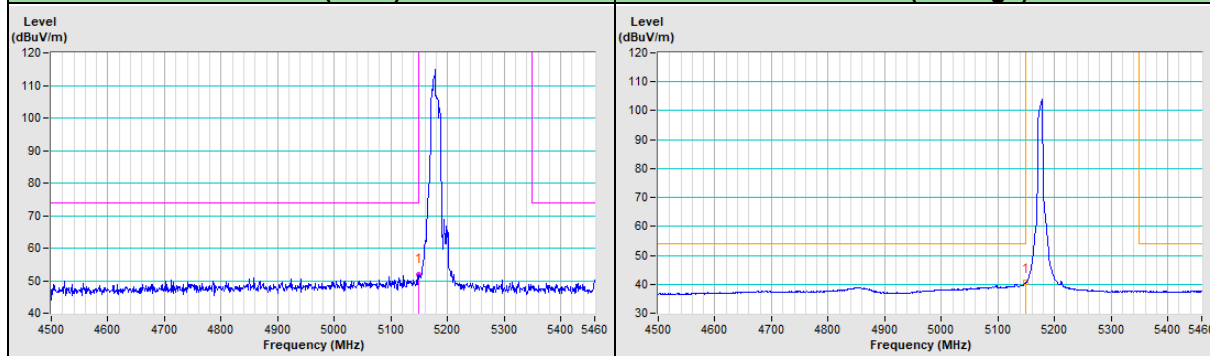

20MHz Preamble 802.11ax (RU106) Channel 64

Horizontal (Peak)	Horizontal (Average)
-------------------	----------------------

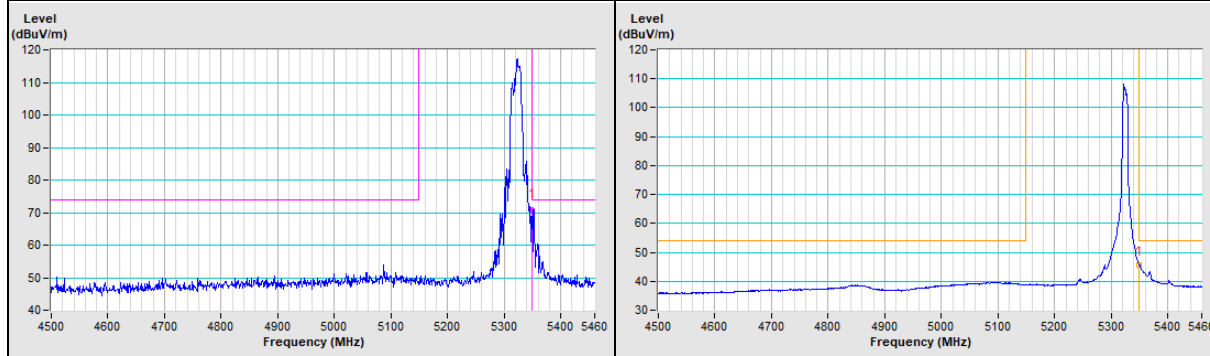

Vertical (Peak)	Vertical (Average)
-----------------	--------------------

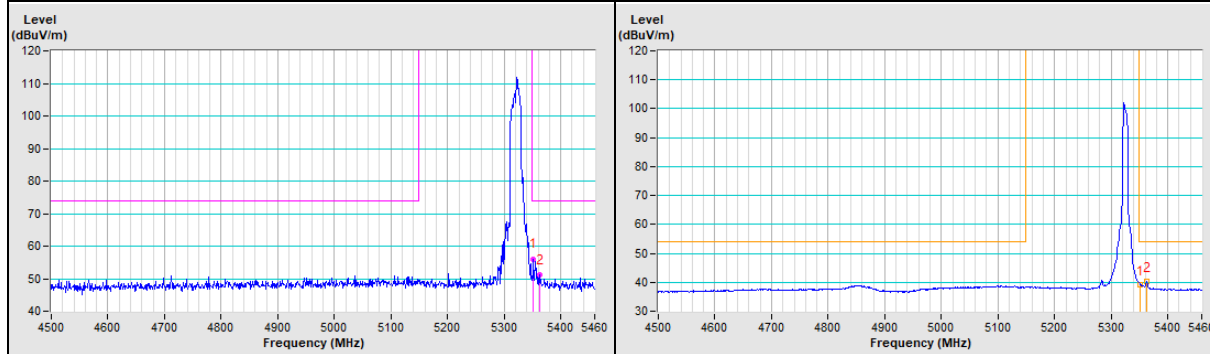

20MHz Preamble 802.11ax (RU106) Channel 100

Horizontal (Peak)

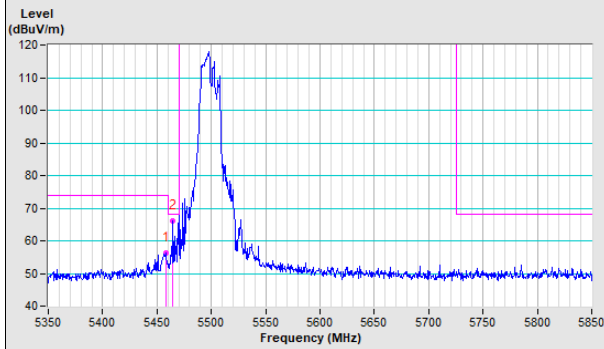

Horizontal (Average)

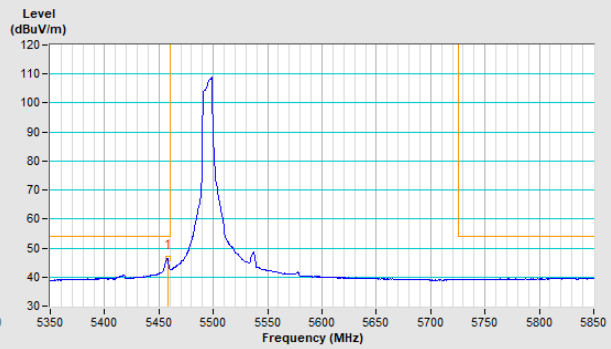

Vertical (Peak)

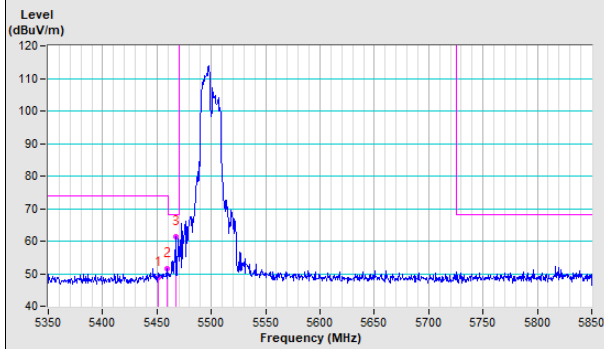

Vertical (Average)

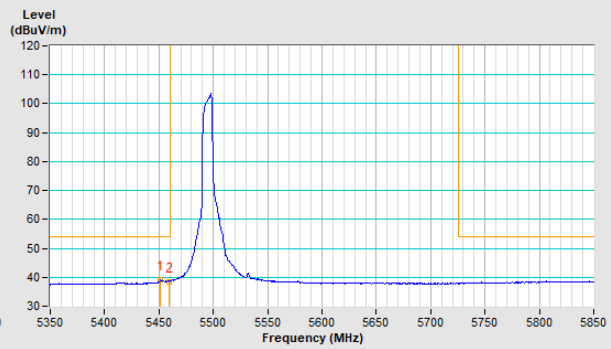

Annex B.1 - Test Results (Mode 2)

Dipole Antenna

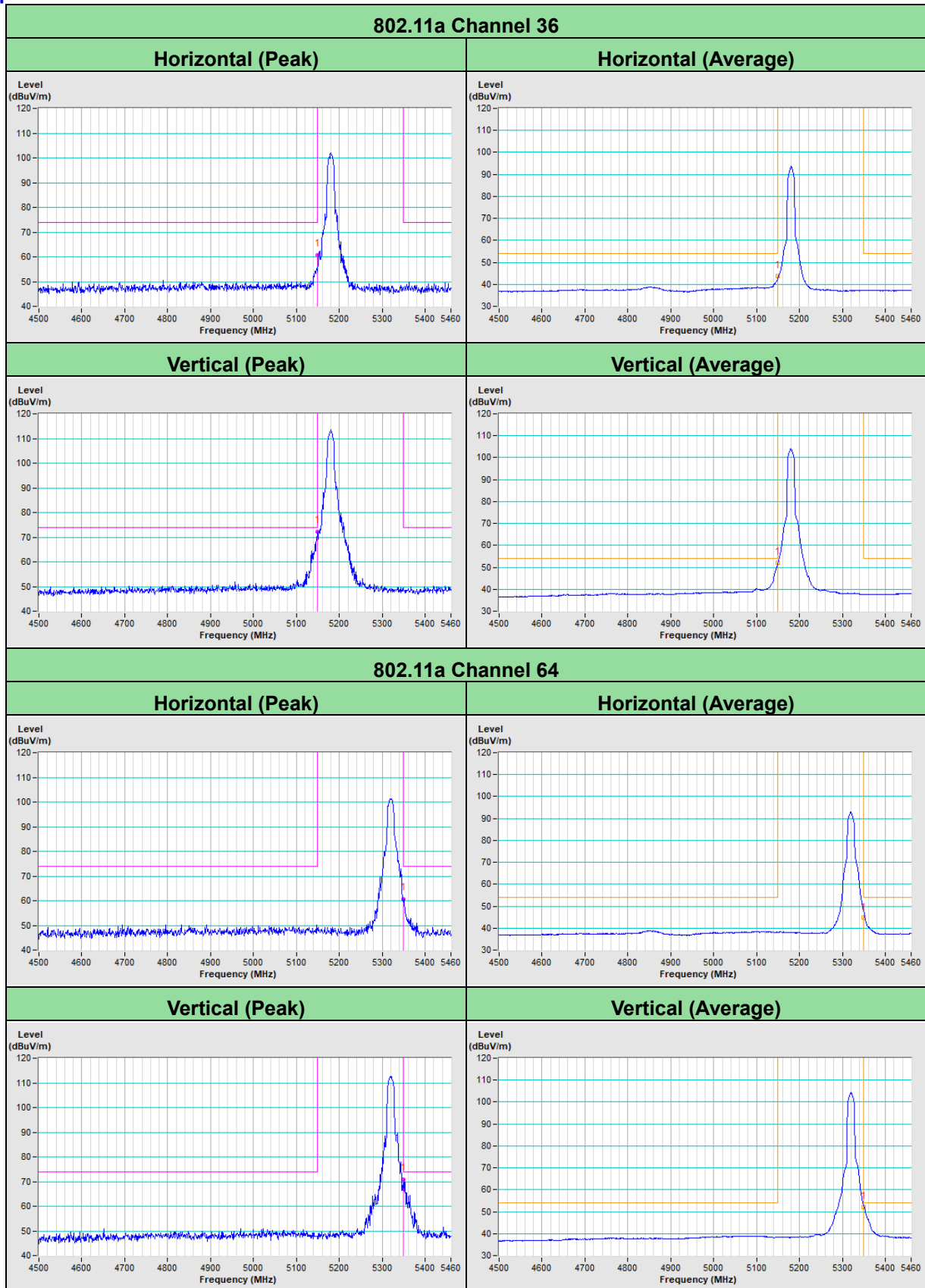

802.11a Channel 100

Horizontal (Peak)

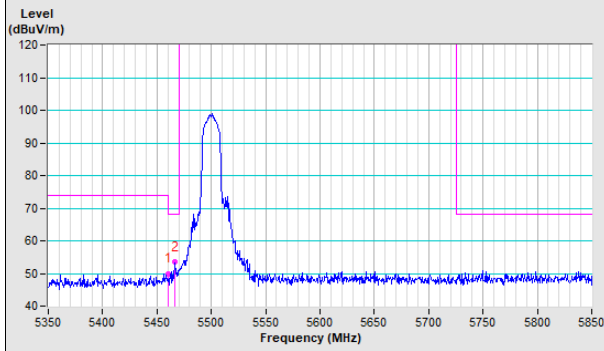

Horizontal (Average)

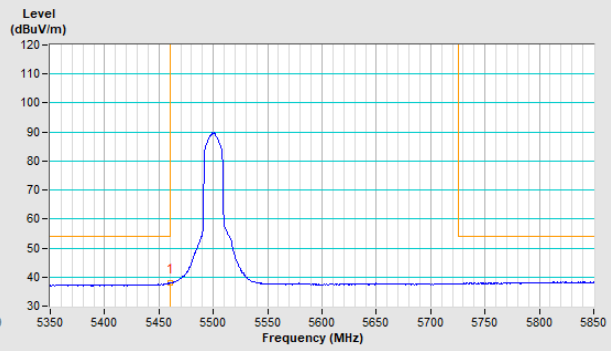

Vertical (Peak)

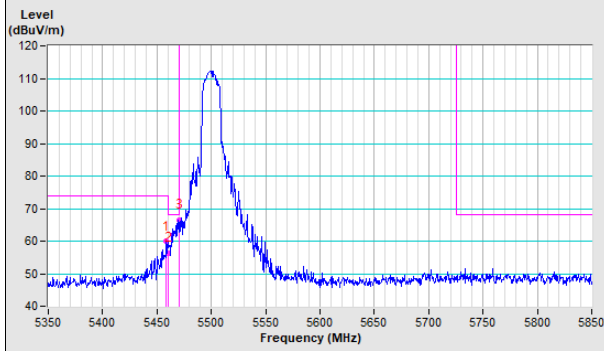

Vertical (Average)

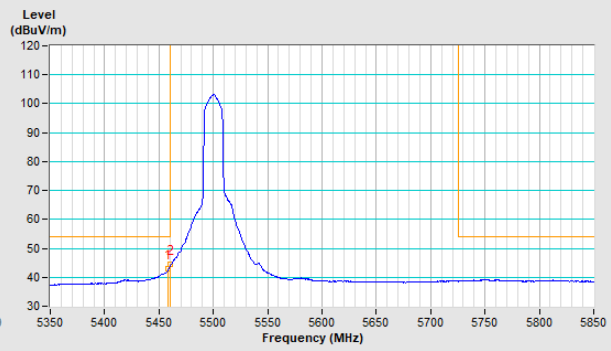

802.11ax (HE20) Channel 36

Horizontal (Peak)	Horizontal (Average)
--------------------------	-----------------------------

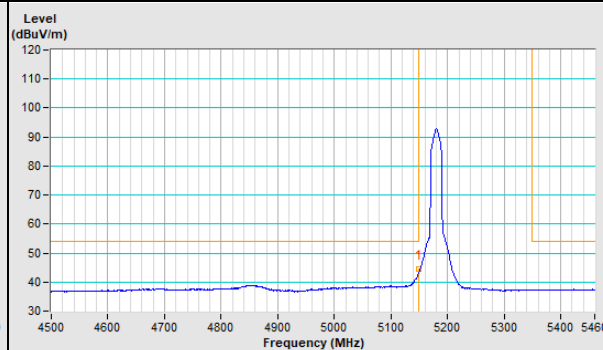
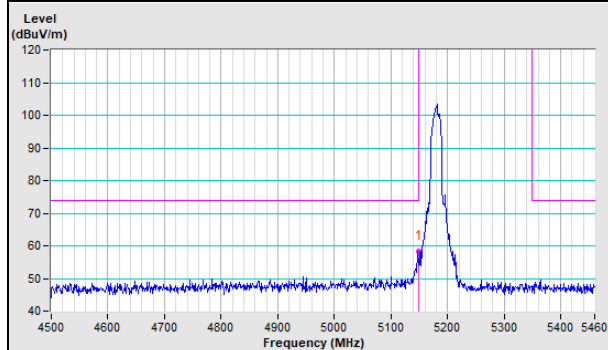

Vertical (Peak)	Vertical (Average)
------------------------	---------------------------

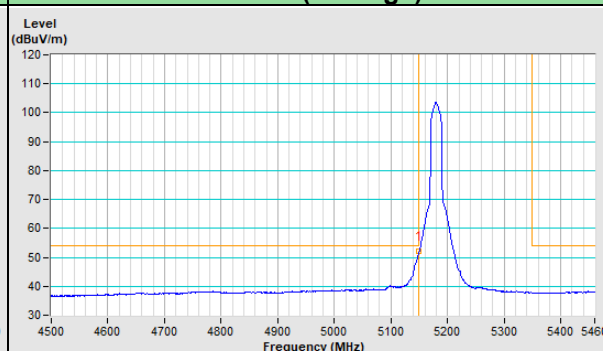
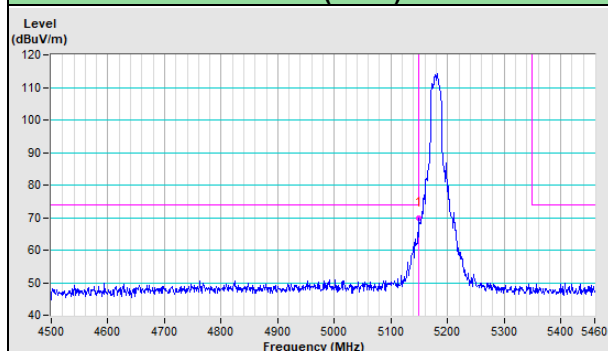

802.11ax (HE20) Channel 64

Horizontal (Peak)	Horizontal (Average)
--------------------------	-----------------------------

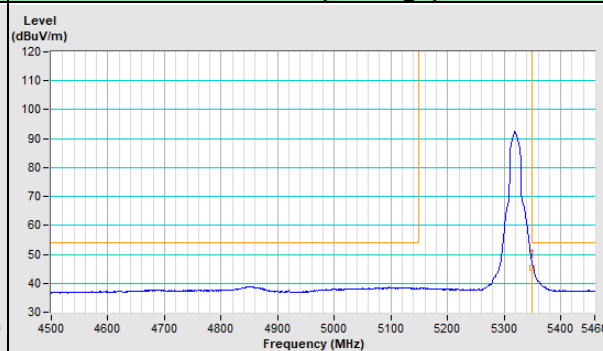
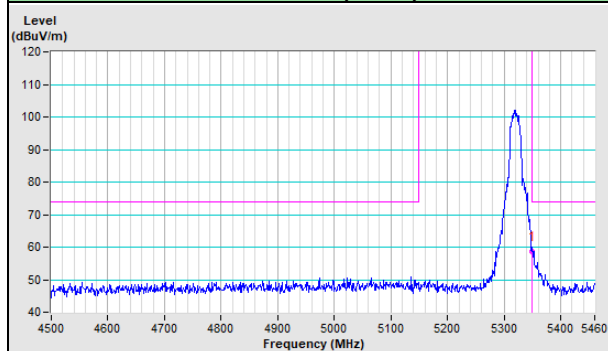

Vertical (Peak)	Vertical (Average)
------------------------	---------------------------

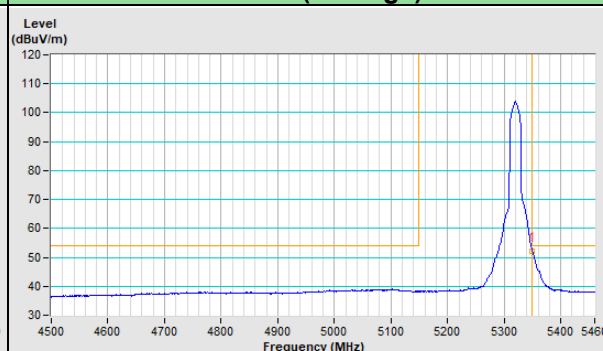
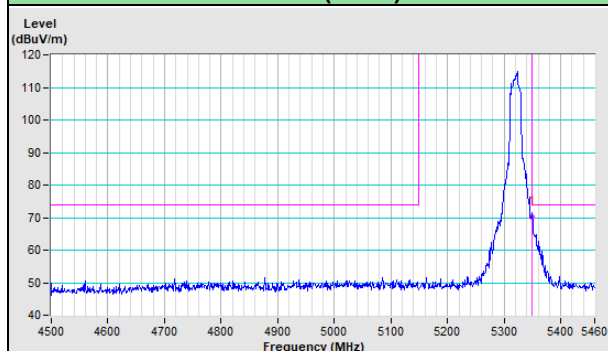

802.11ax (HE20) Channel 100

Horizontal (Peak)

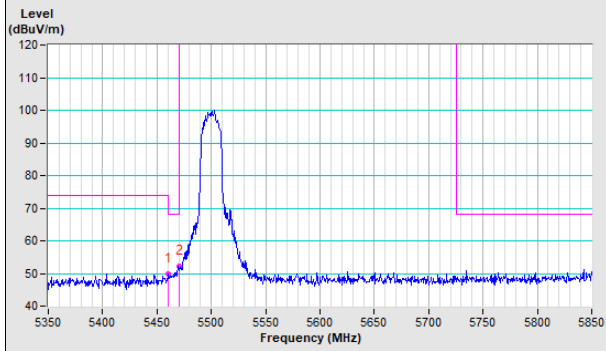

Horizontal (Average)

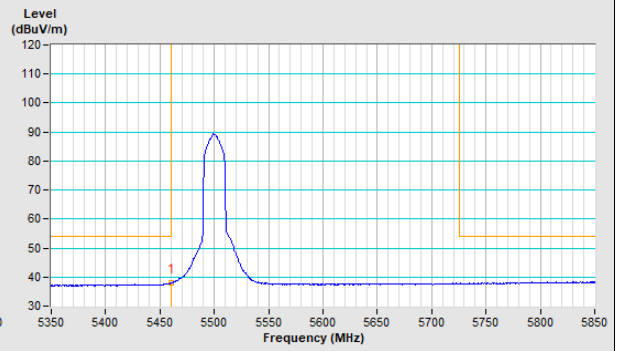

Vertical (Peak)

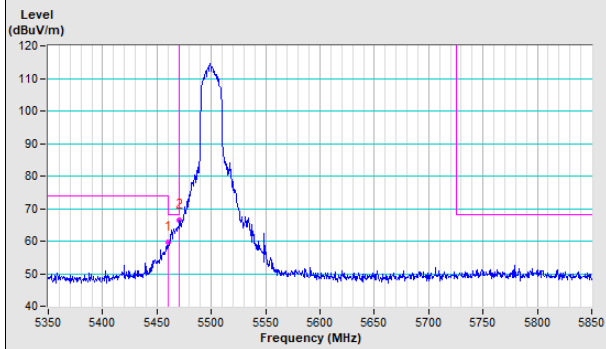

Vertical (Average)

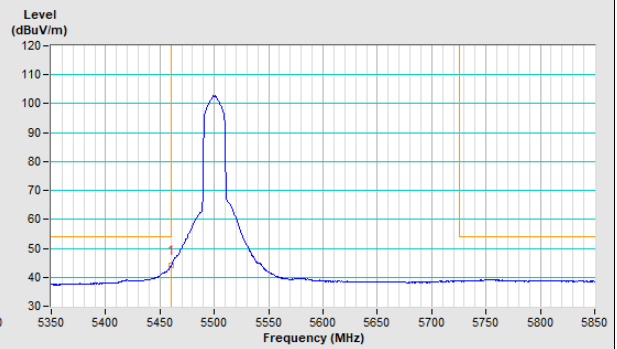

802.11ax (HE40) Channel 38

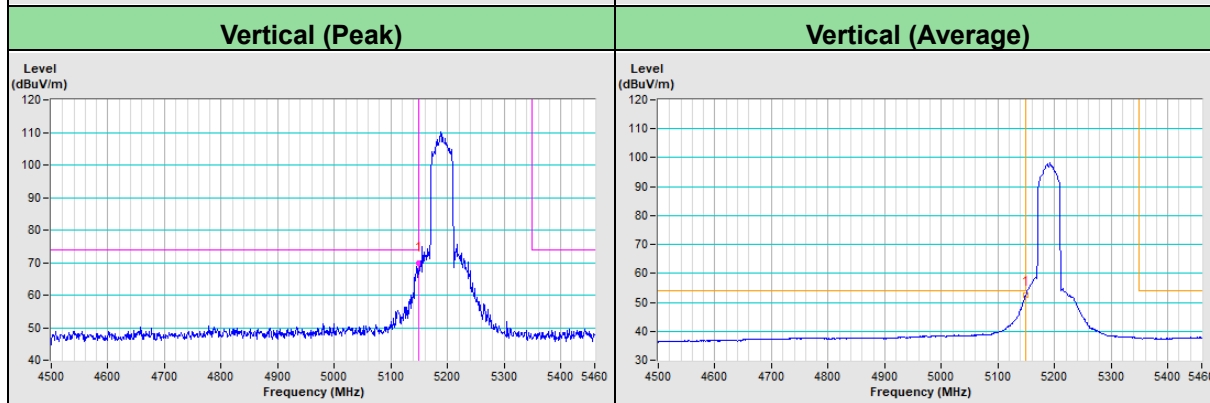
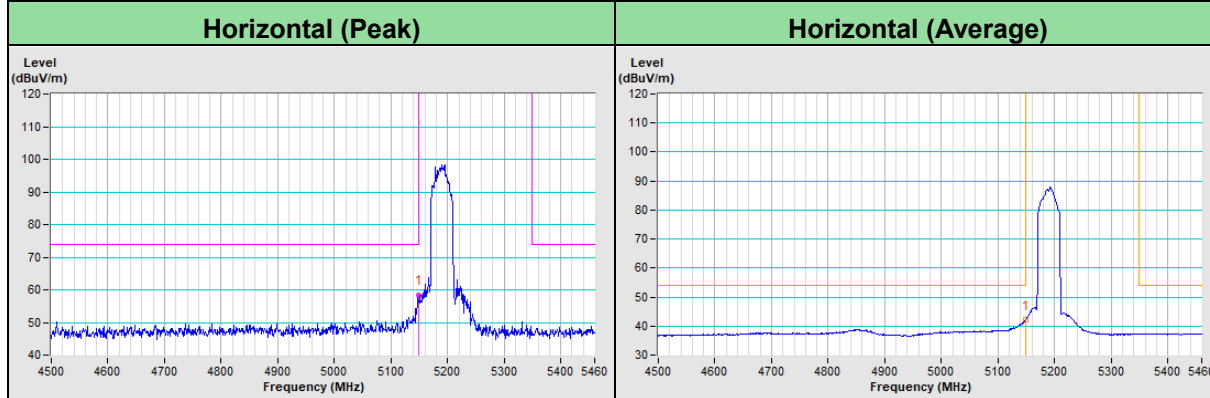

802.11ax (HE40) Channel 62

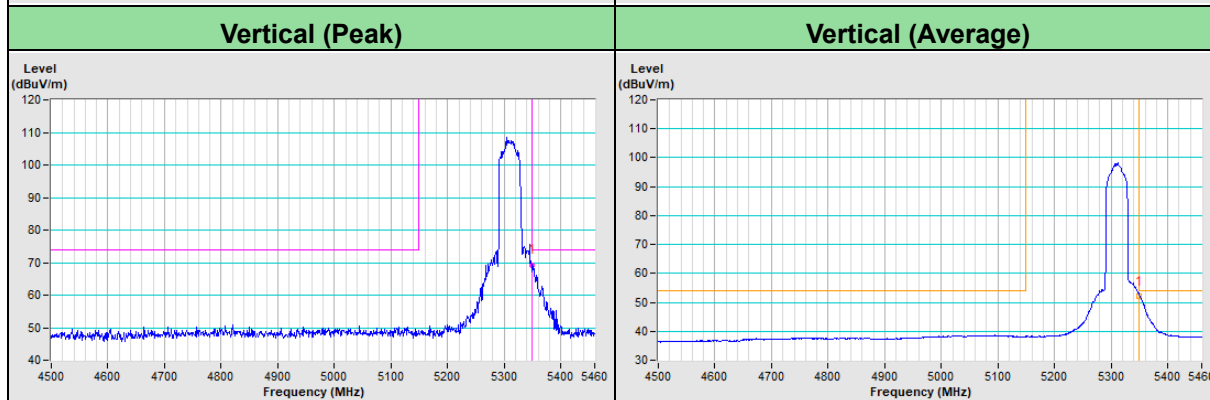
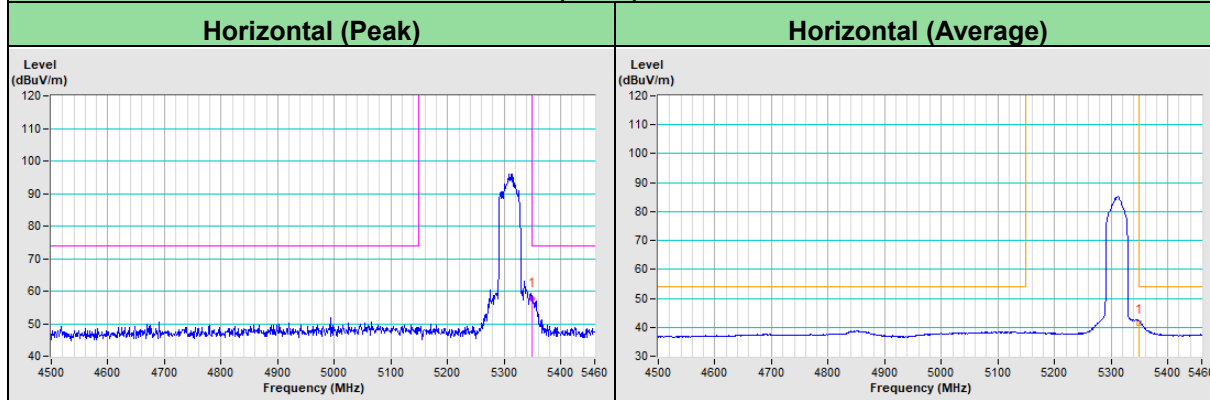

802.11ax (HE40) Channel 102

Horizontal (Peak)

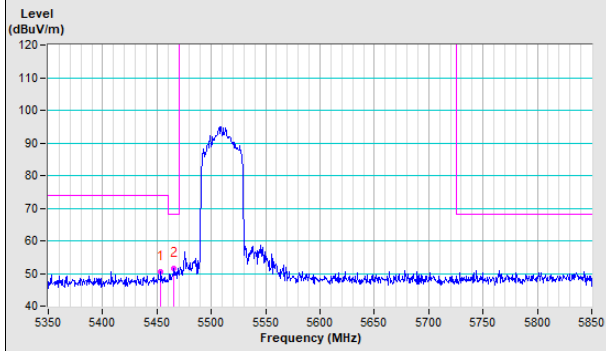

Horizontal (Average)

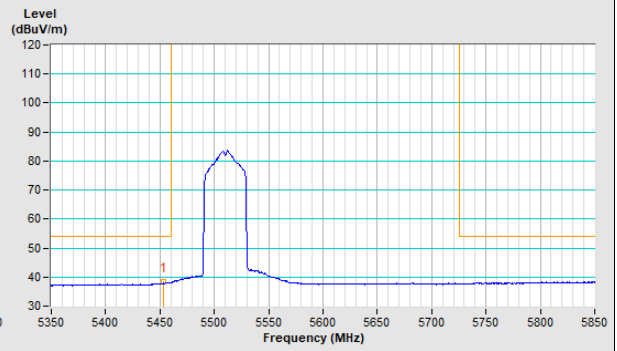

Vertical (Peak)

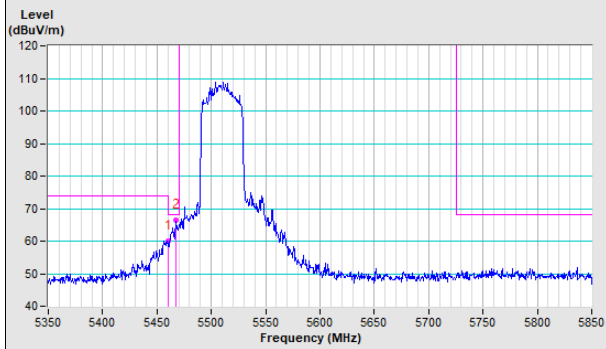

Vertical (Average)

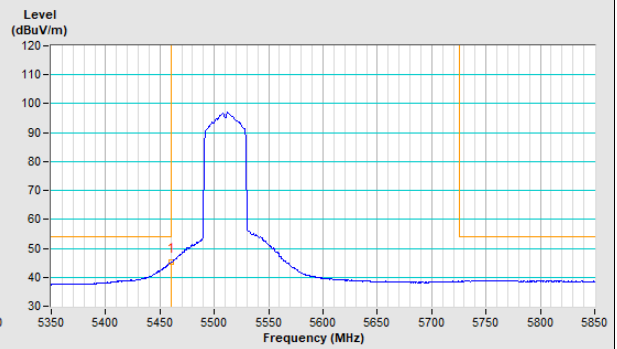

802.11ax (HE80) Channel 42

Horizontal (Peak)	Horizontal (Average)
--------------------------	-----------------------------

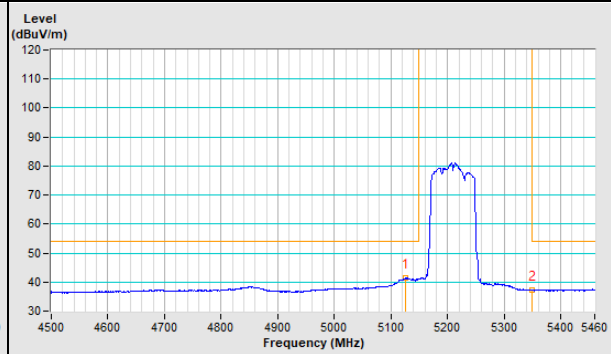
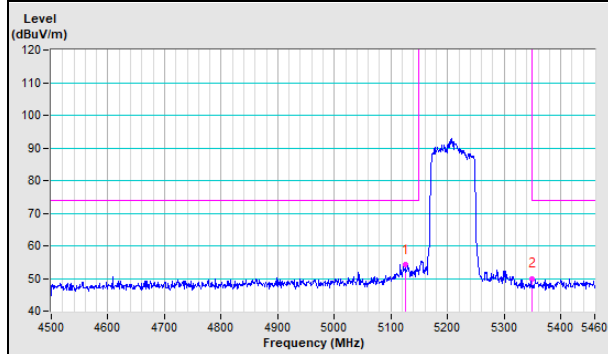

Vertical (Peak)	Vertical (Average)
------------------------	---------------------------

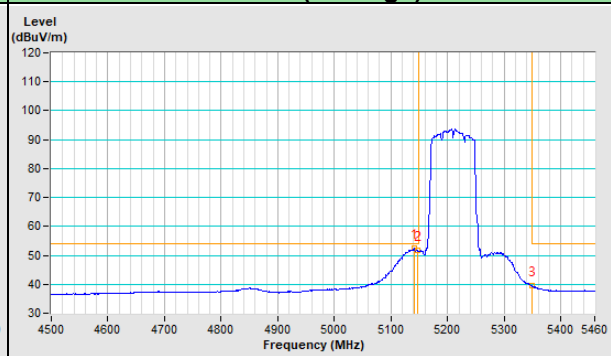
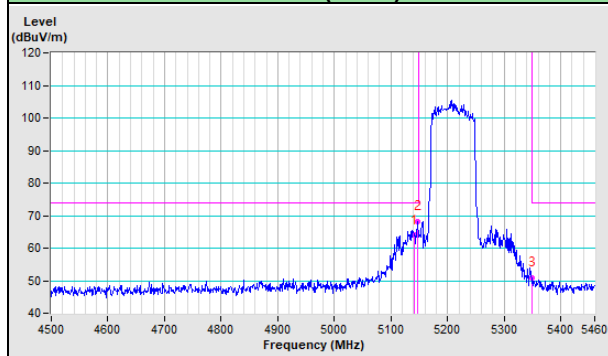

802.11ax (HE80) Channel 58

Horizontal (Peak)	Horizontal (Average)
--------------------------	-----------------------------

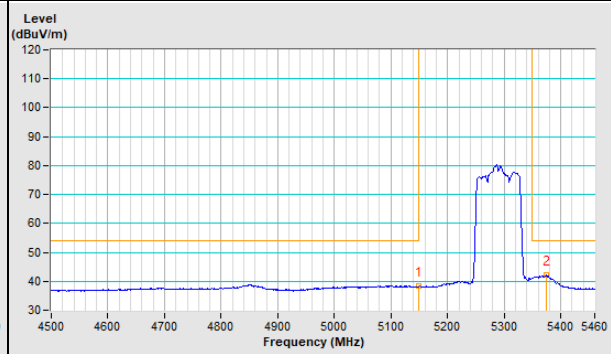
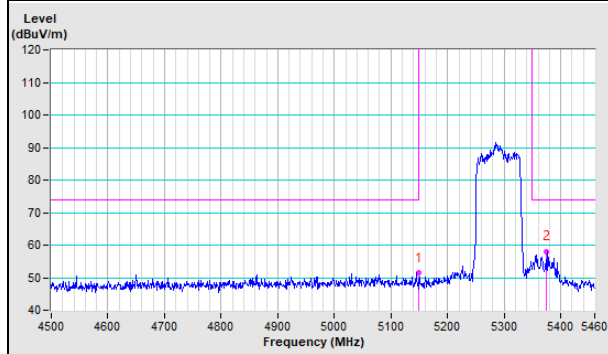

Vertical (Peak)	Vertical (Average)
------------------------	---------------------------

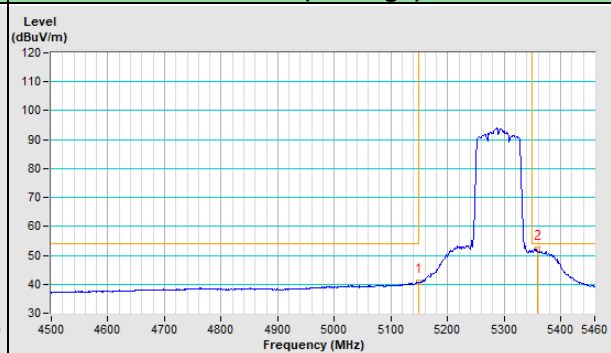
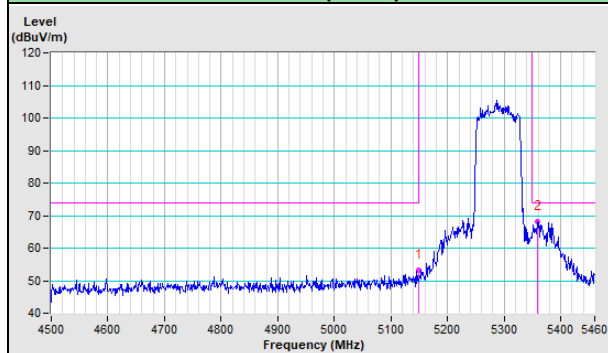

802.11ax (HE80) Channel 106

Horizontal (Peak)

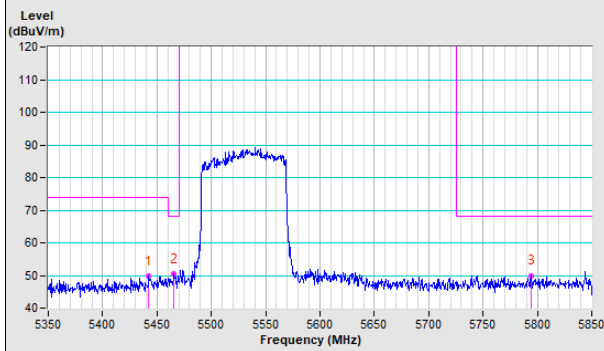

Horizontal (Average)

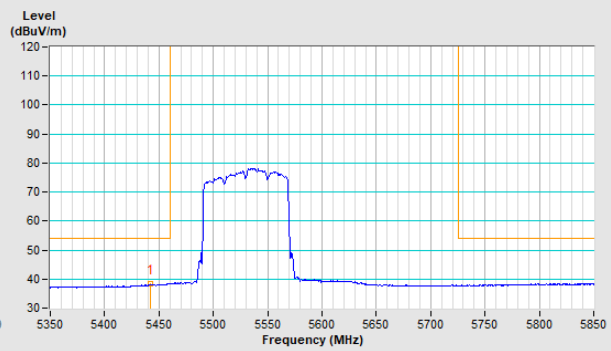

Vertical (Peak)

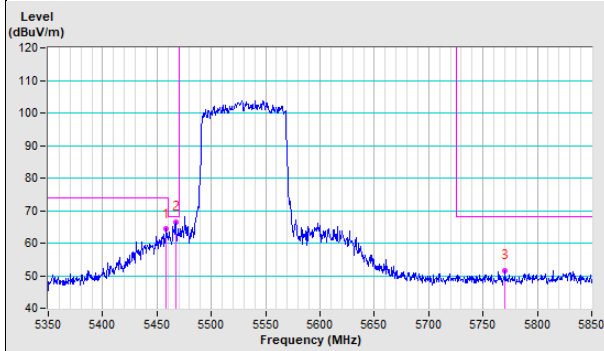

Vertical (Average)

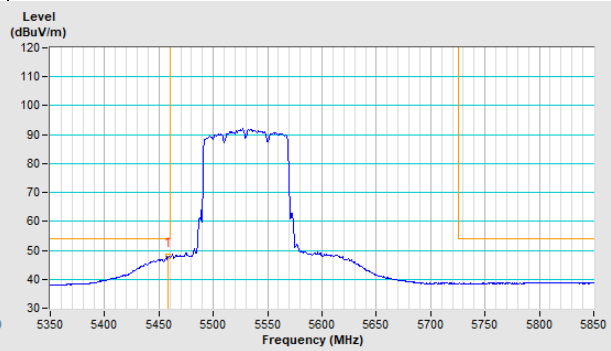

20MHz Preamble 802.11ax (RU26) Channel 36

Horizontal (Peak)

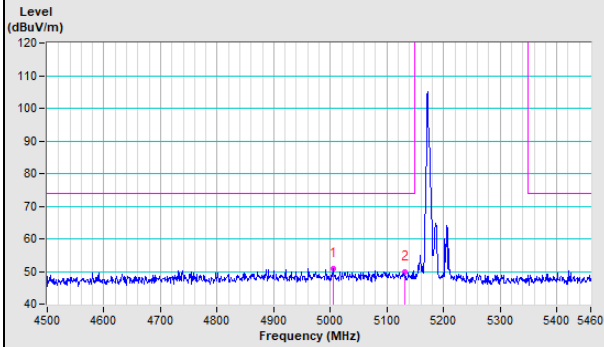

Horizontal (Average)

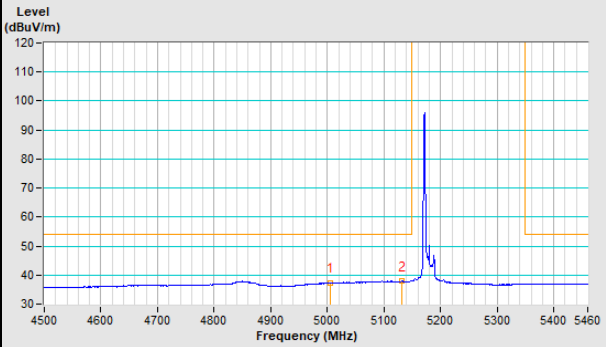

Vertical (Peak)

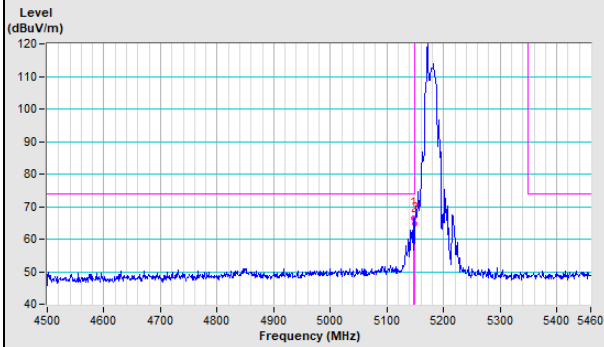

Vertical (Average)

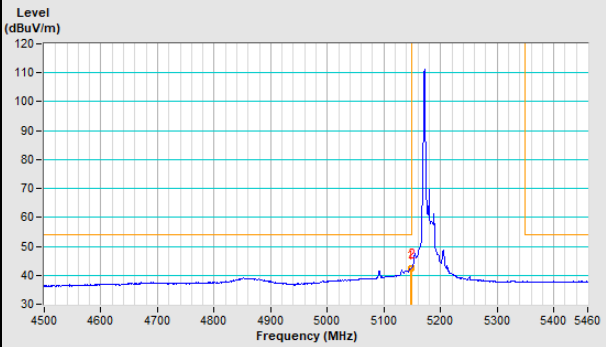

20MHz Preamble 802.11ax (RU26) Channel 64

Horizontal (Peak)

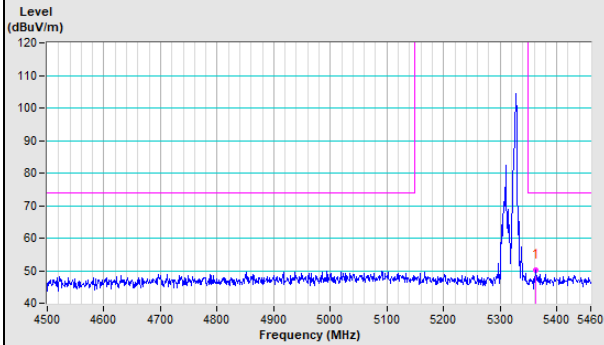

Horizontal (Average)

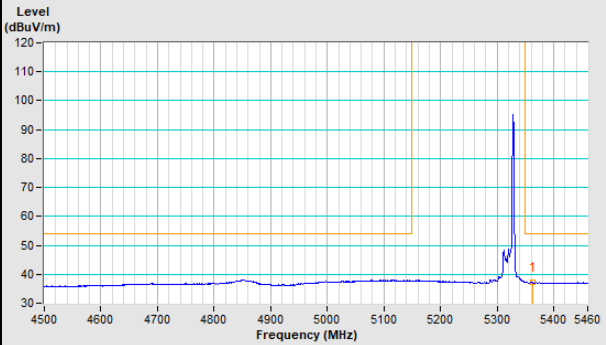

Vertical (Peak)

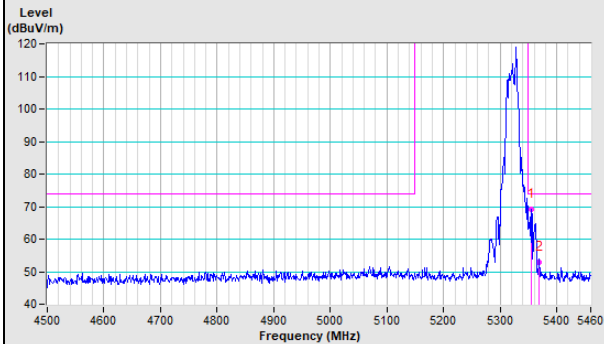

Vertical (Average)

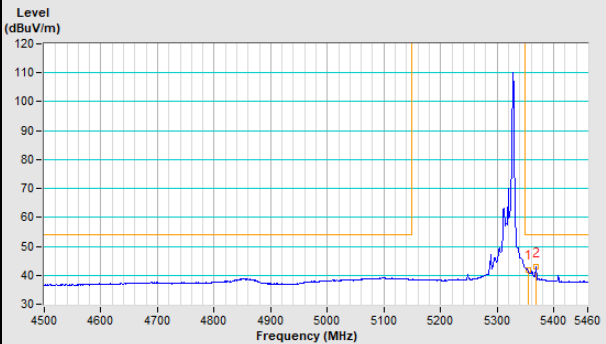

20MHz Preamble 802.11ax (RU26) Channel 100

Horizontal (Peak)

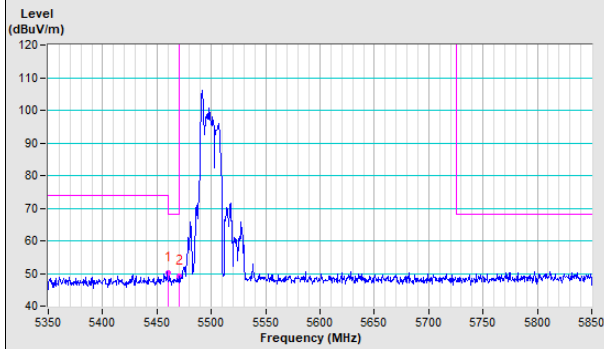

Horizontal (Average)

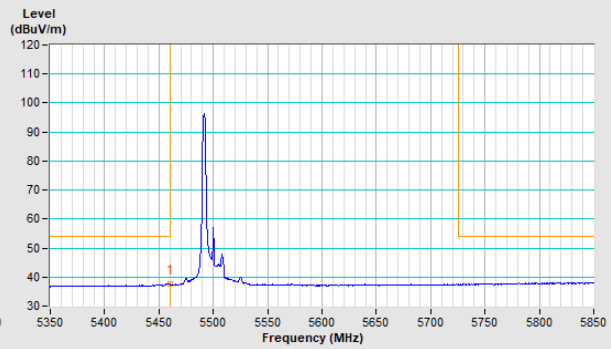

Vertical (Peak)

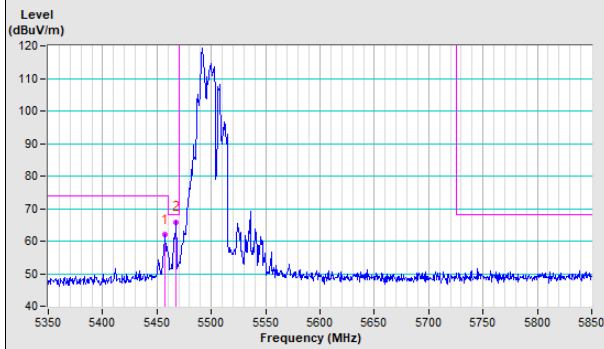

Vertical (Average)

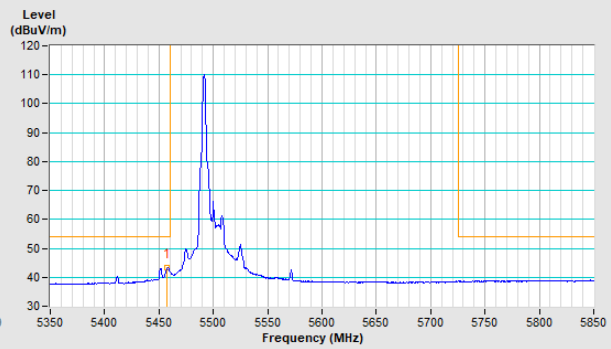

20MHz Preamble 802.11ax (RU52) Channel 100

Horizontal (Peak)

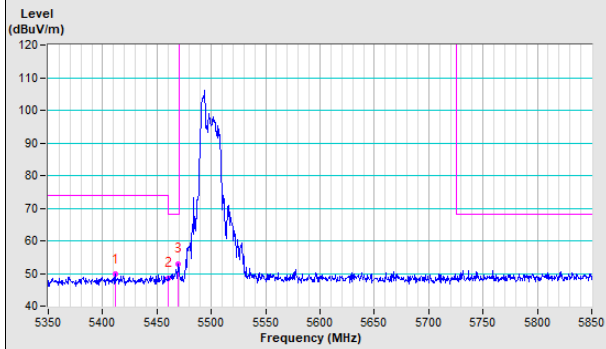

Horizontal (Average)

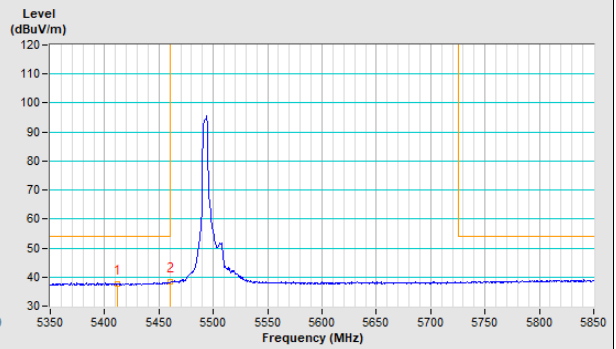

Vertical (Peak)

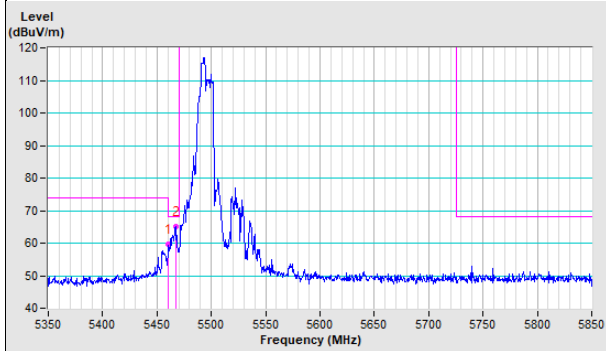

Vertical (Average)

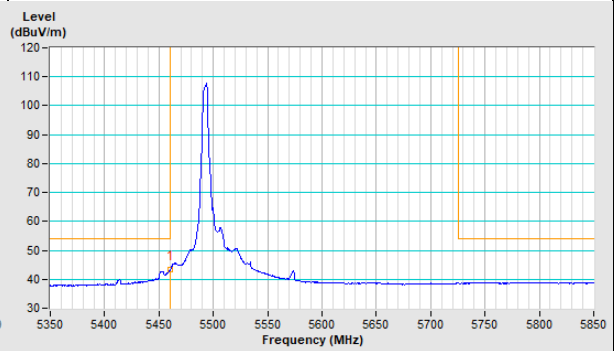

20MHz Preamble 802.11ax (RU106) Channel 36

Horizontal (Peak)

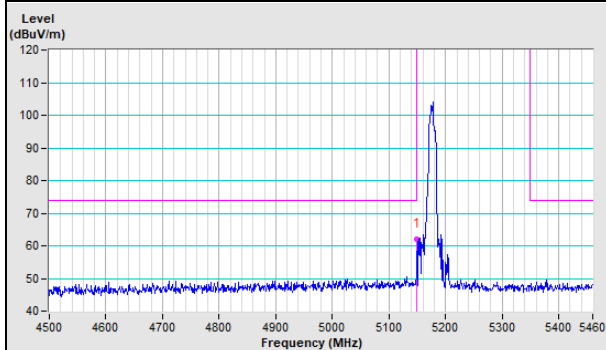

Horizontal (Average)

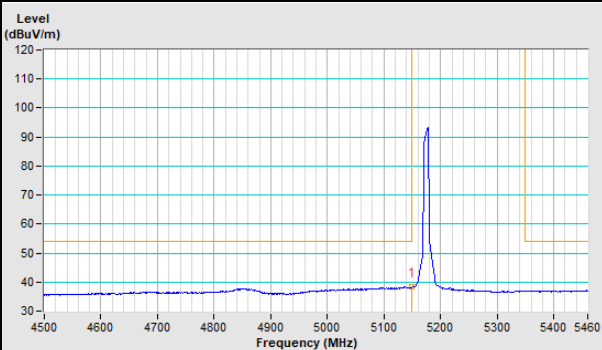

Vertical (Peak)

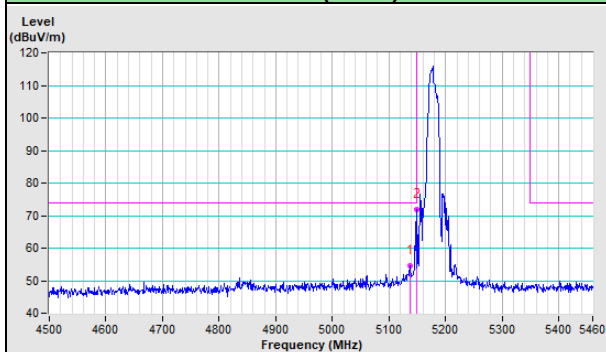

Vertical (Average)

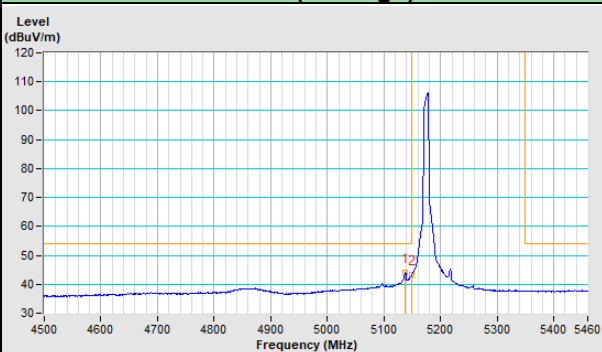

20MHz Preamble 802.11ax (RU106) Channel 64

Horizontal (Peak)

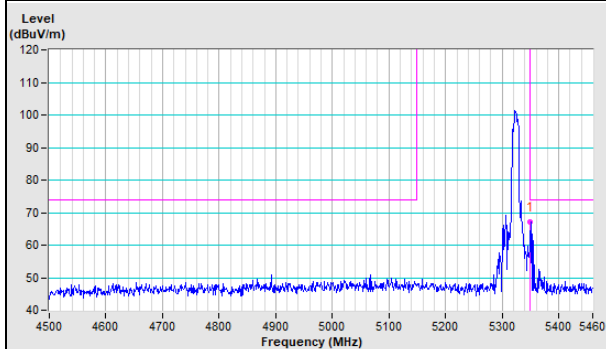

Horizontal (Average)

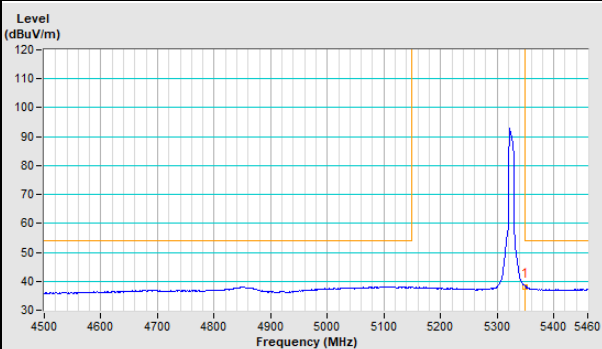

Vertical (Peak)

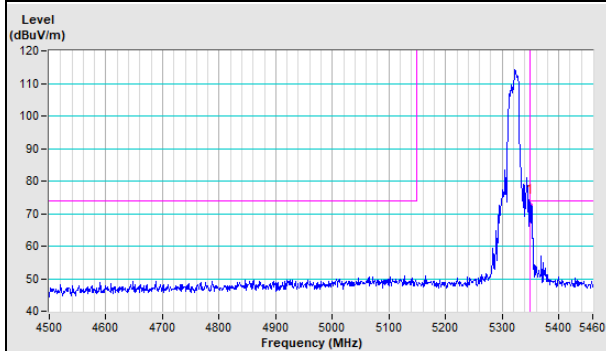

Vertical (Average)

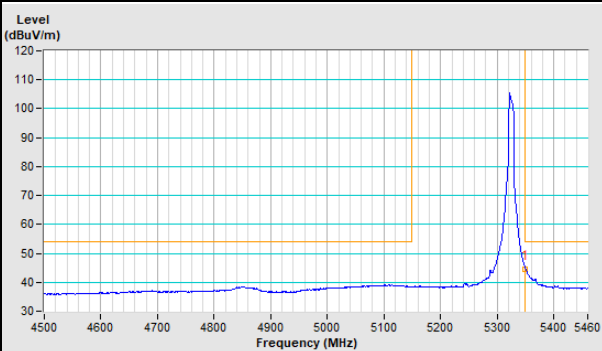

20MHz Preamble 802.11ax (RU106) Channel 100

Horizontal (Peak)	Horizontal (Average)
--------------------------	-----------------------------

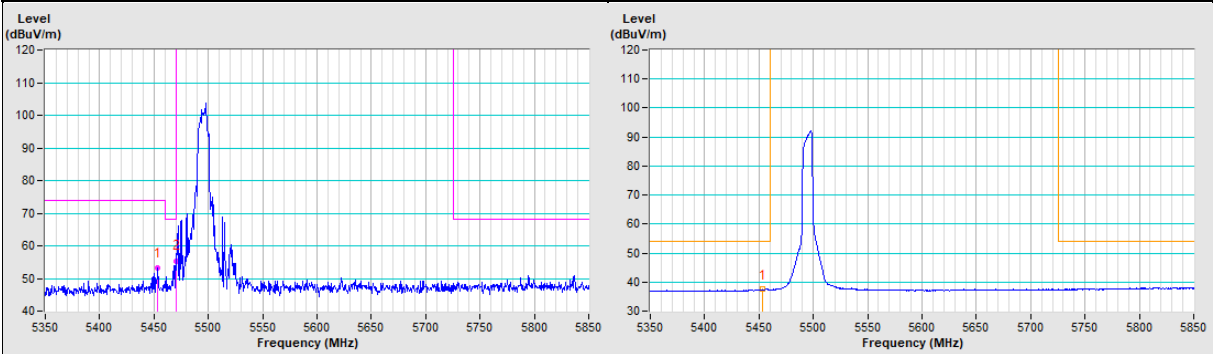

Vertical (Peak)	Vertical (Average)
------------------------	---------------------------

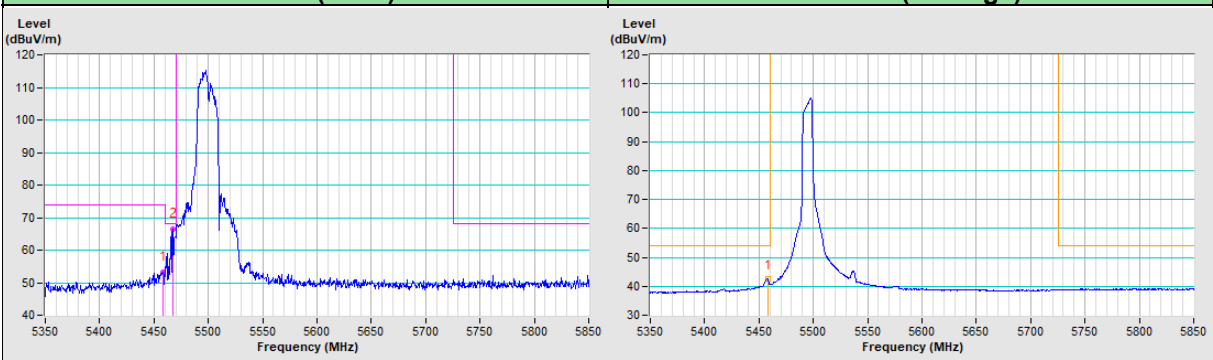

PIFA Antenna

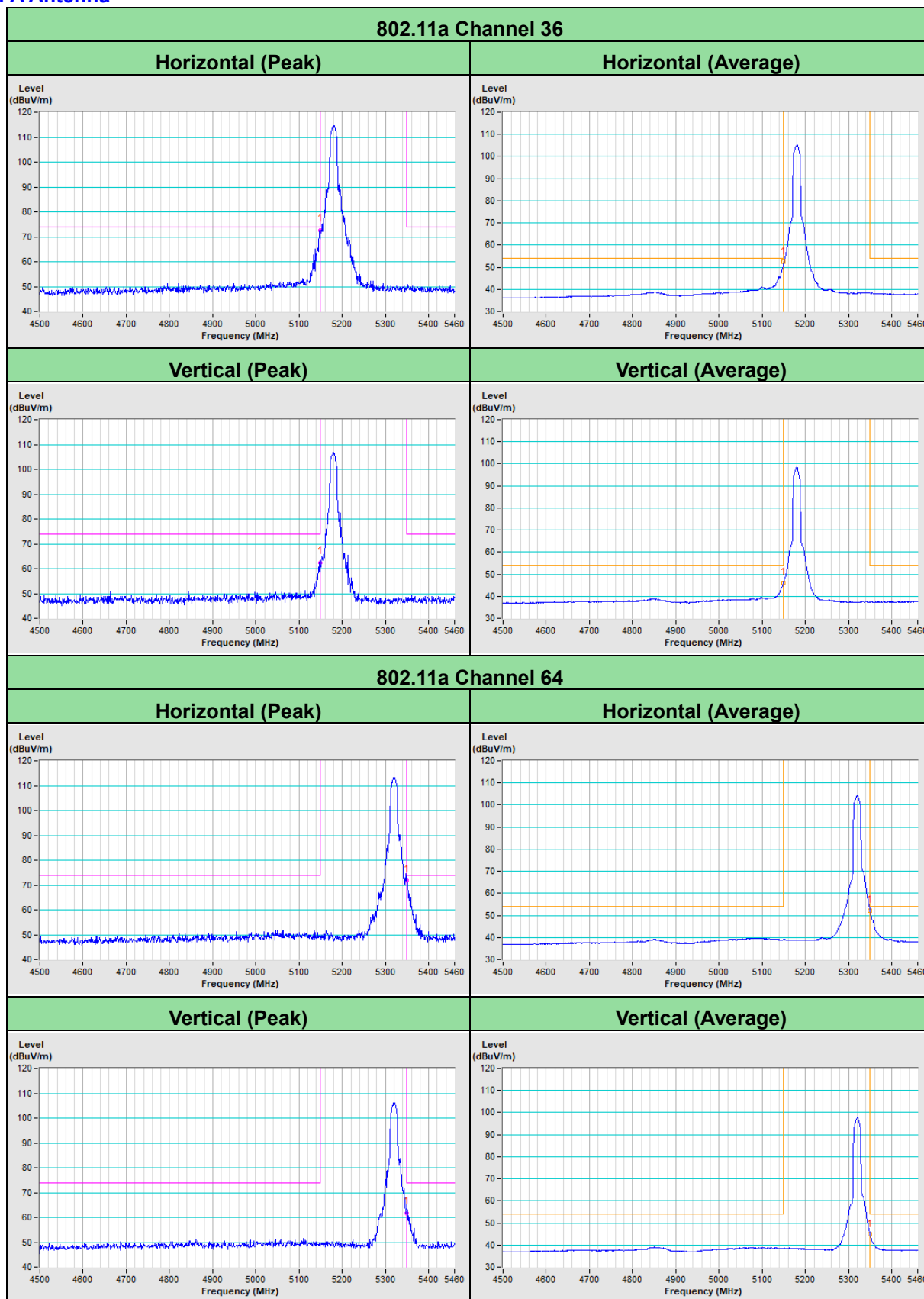

802.11a Channel 100

Horizontal (Peak)

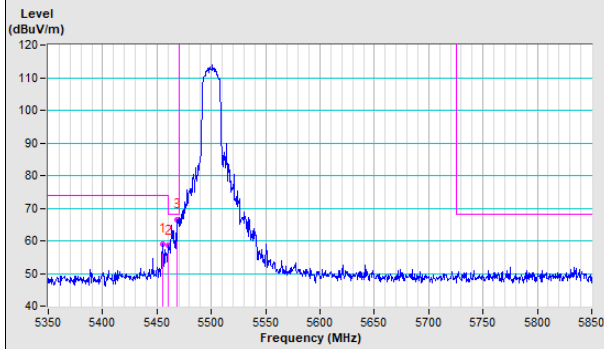

Horizontal (Average)

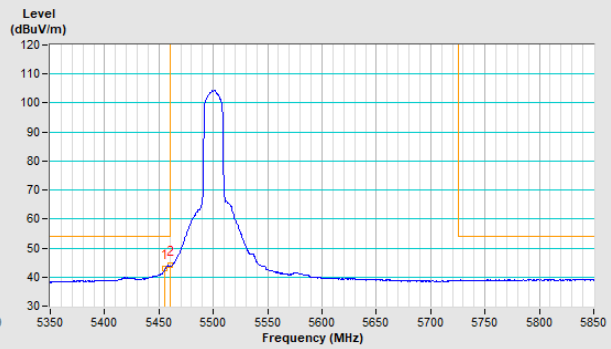

Vertical (Peak)

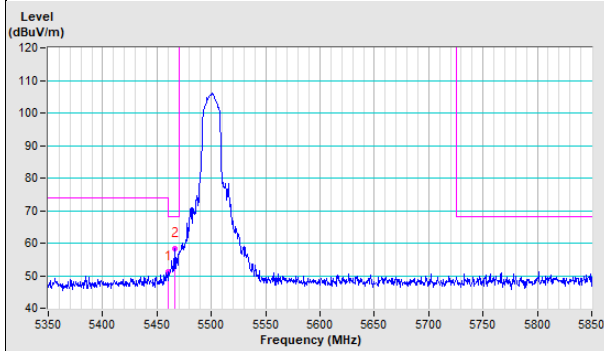

Vertical (Average)

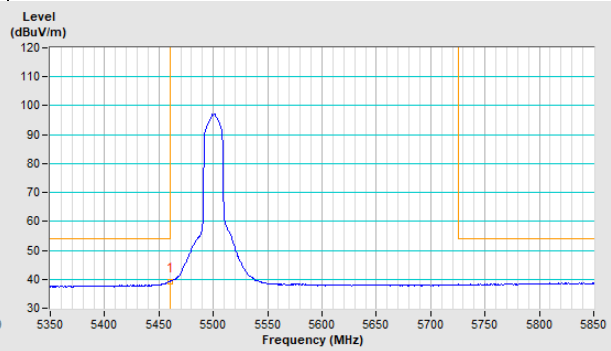

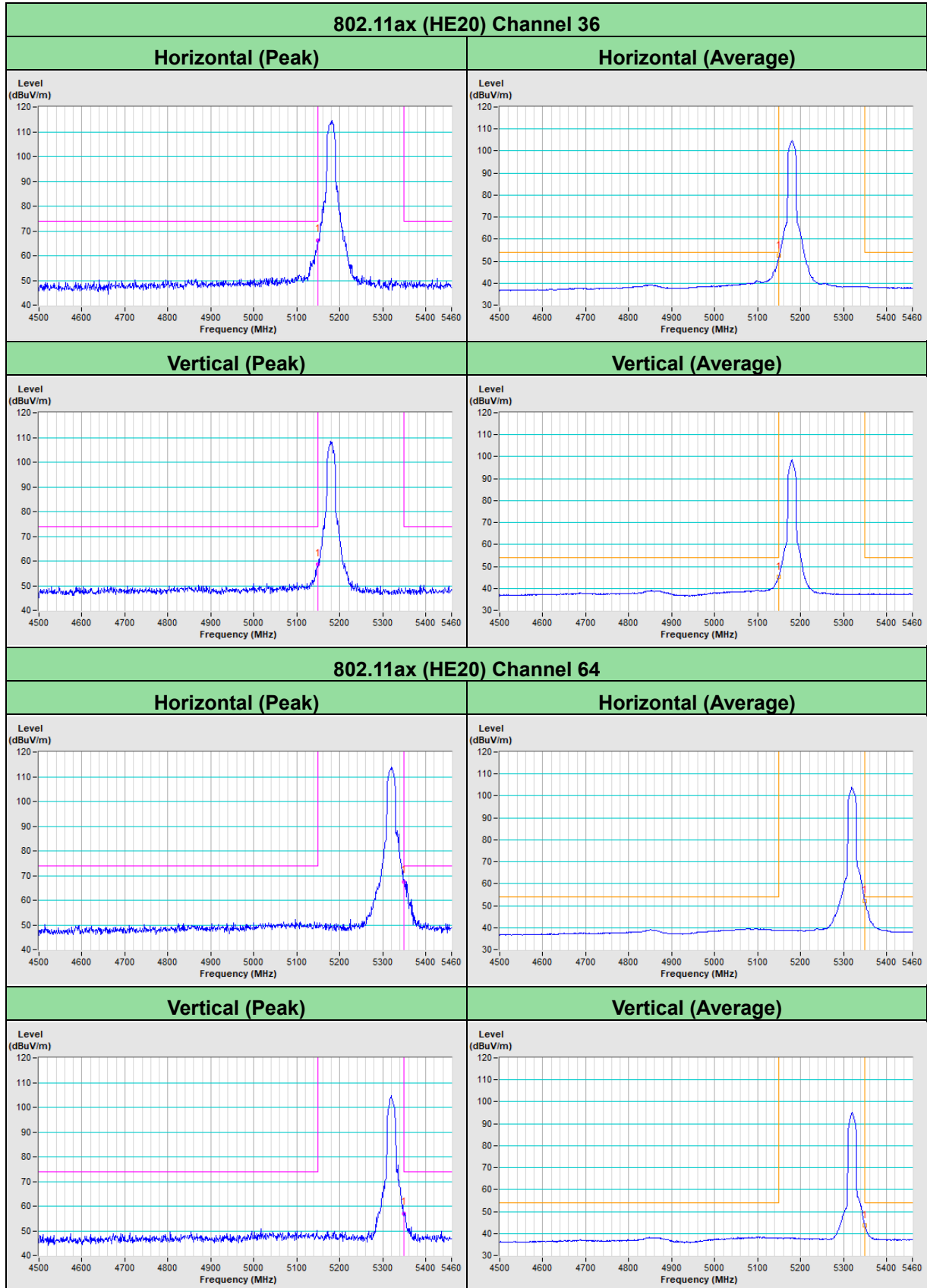

802.11ax (HE20) Channel 100

Horizontal (Peak)

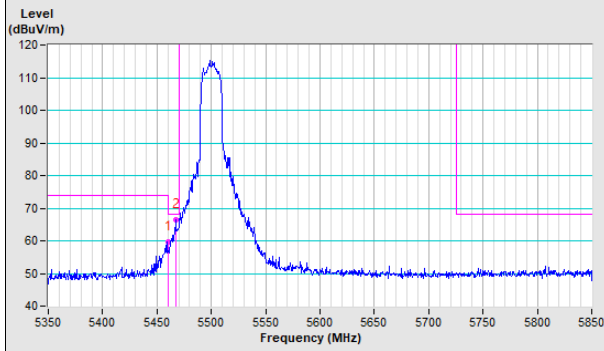

Horizontal (Average)

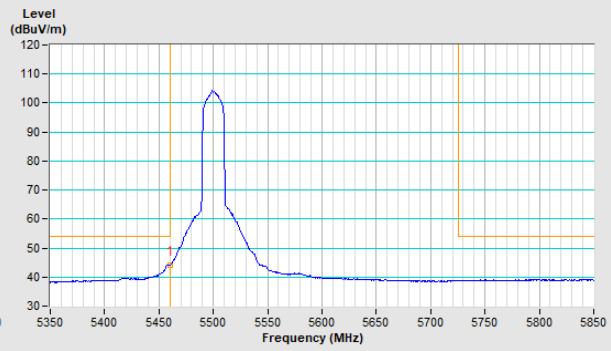

Vertical (Peak)

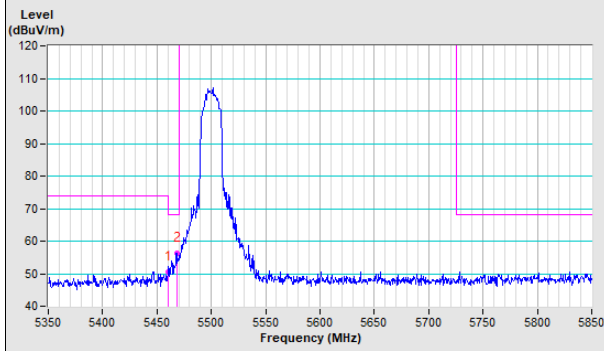

Vertical (Average)

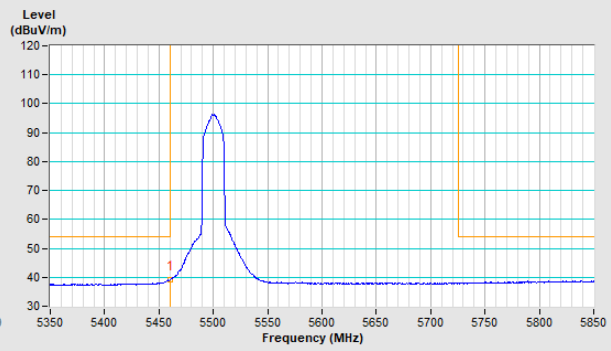

802.11ax (HE40) Channel 38

Horizontal (Peak)	Horizontal (Average)
--------------------------	-----------------------------

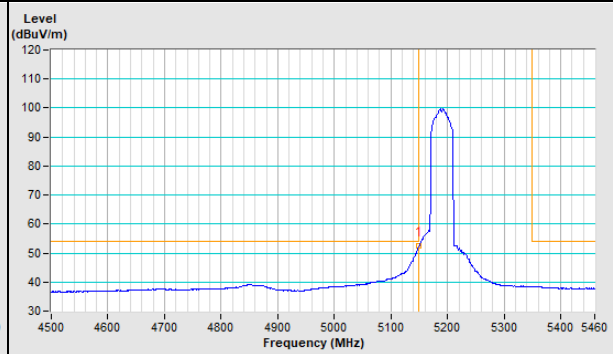
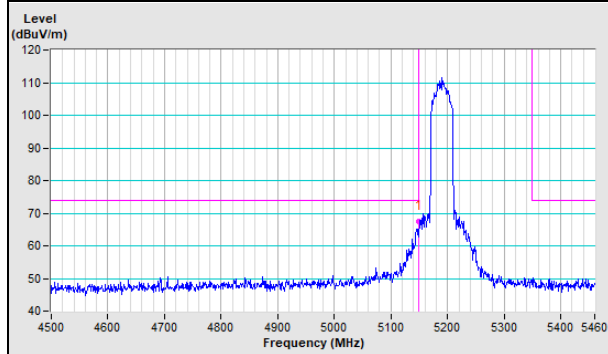

Vertical (Peak)	Vertical (Average)
------------------------	---------------------------

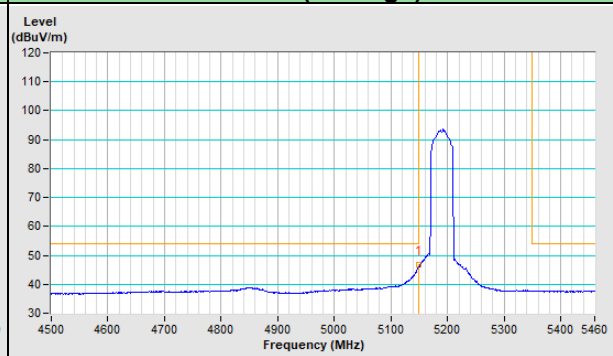
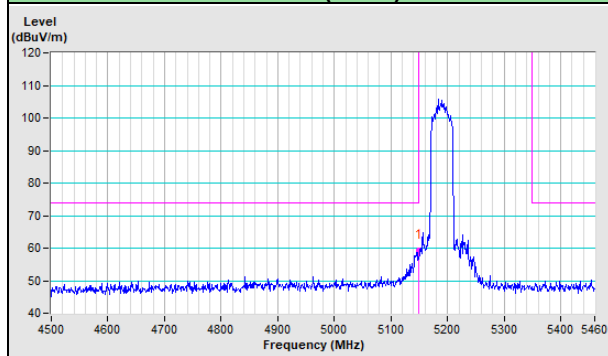

802.11ax (HE40) Channel 62

Horizontal (Peak)	Horizontal (Average)
--------------------------	-----------------------------

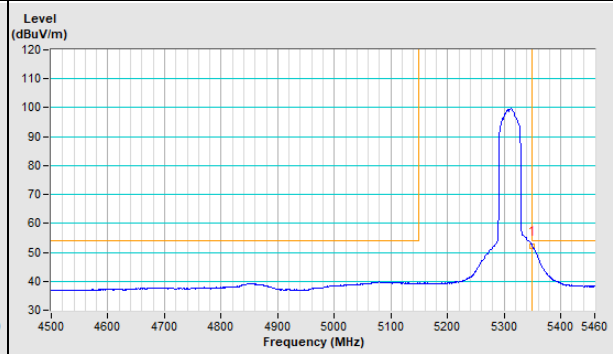
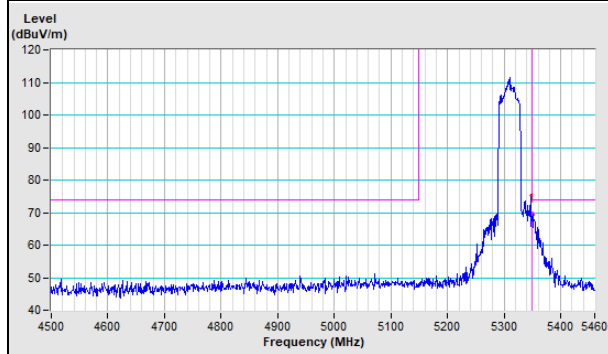

Vertical (Peak)	Vertical (Average)
------------------------	---------------------------

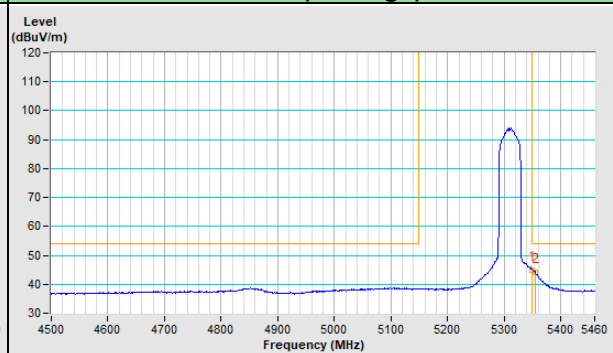
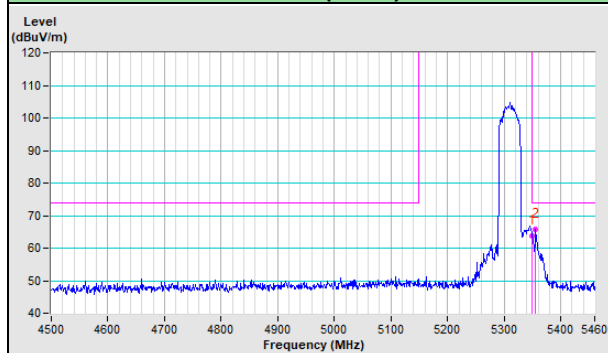

802.11ax (HE40) Channel 102

Horizontal (Peak)

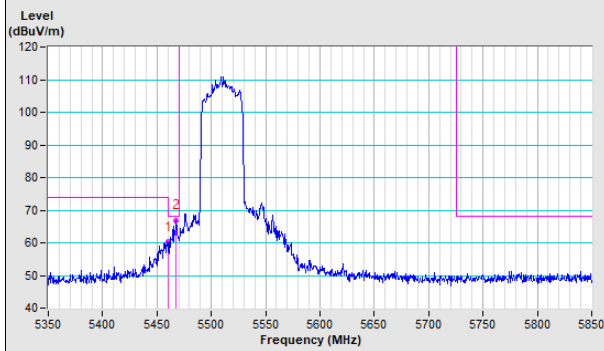

Horizontal (Average)

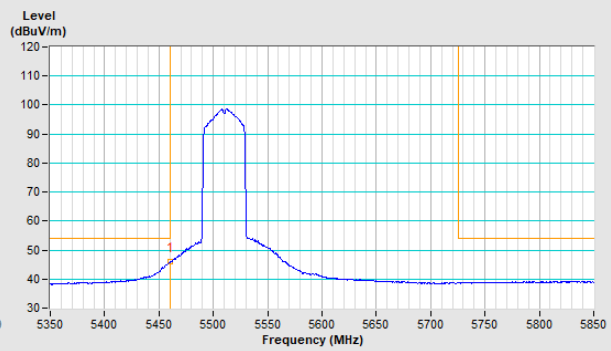

Vertical (Peak)

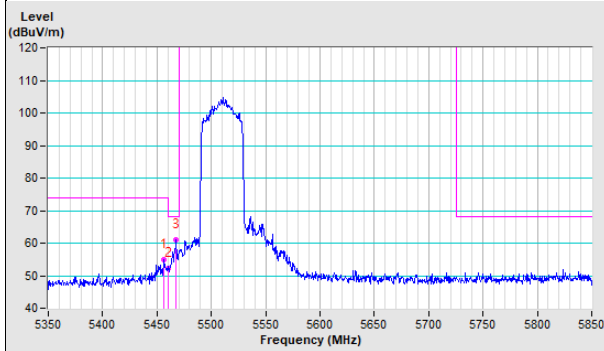

Vertical (Average)

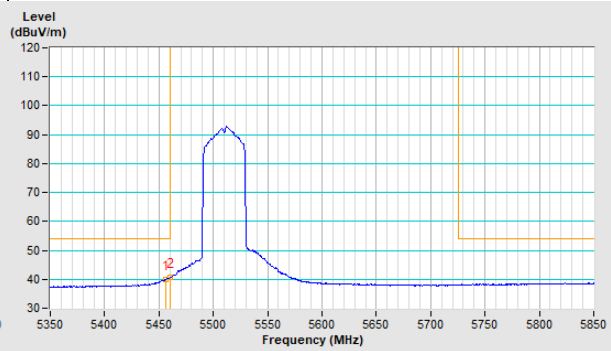

802.11ax (HE80) Channel 42

Horizontal (Peak)	Horizontal (Average)
--------------------------	-----------------------------

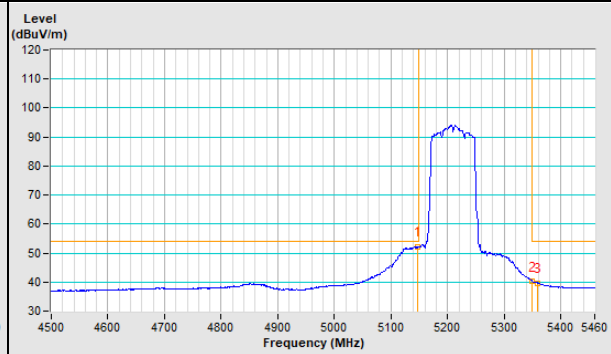
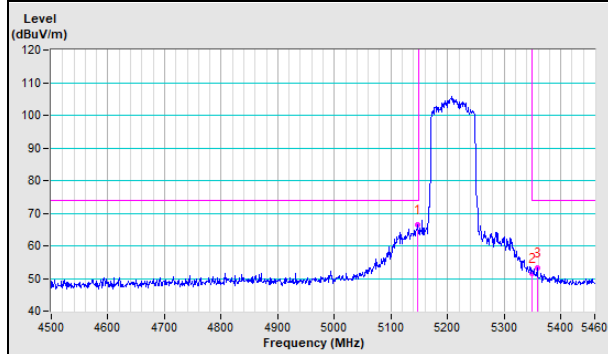

Vertical (Peak)	Vertical (Average)
------------------------	---------------------------

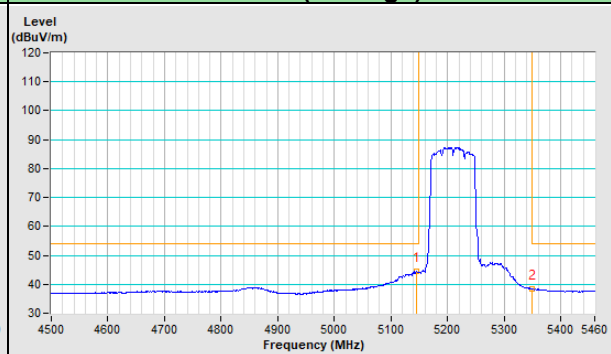
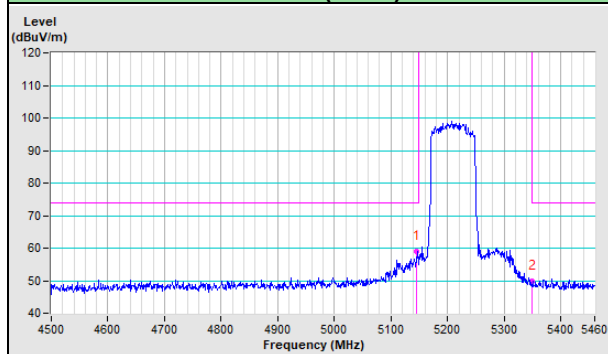

802.11ax (HE80) Channel 58

Horizontal (Peak)	Horizontal (Average)
--------------------------	-----------------------------

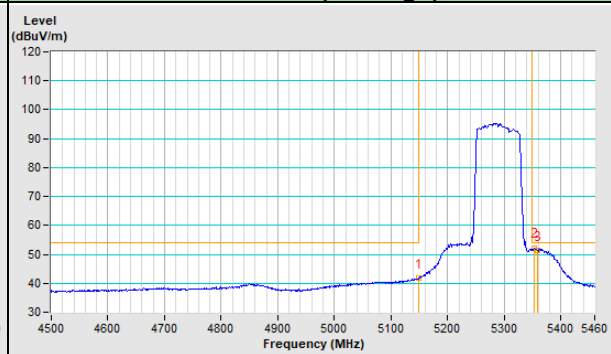
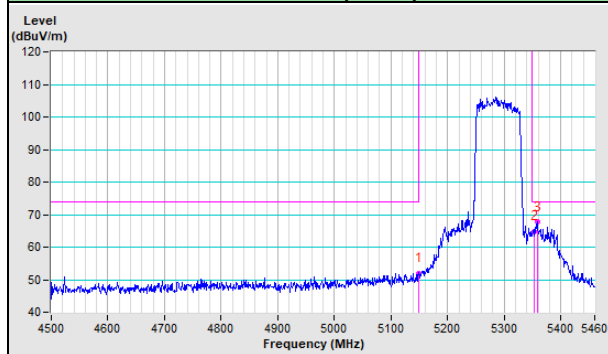

Vertical (Peak)	Vertical (Average)
------------------------	---------------------------

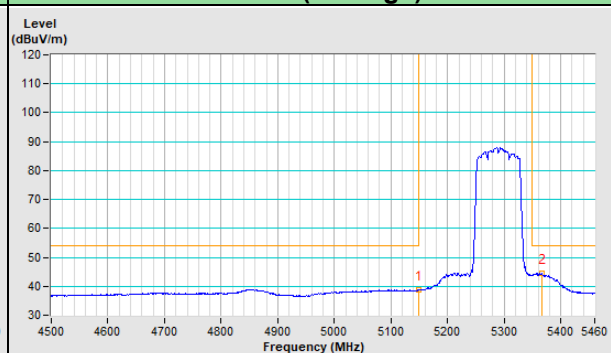
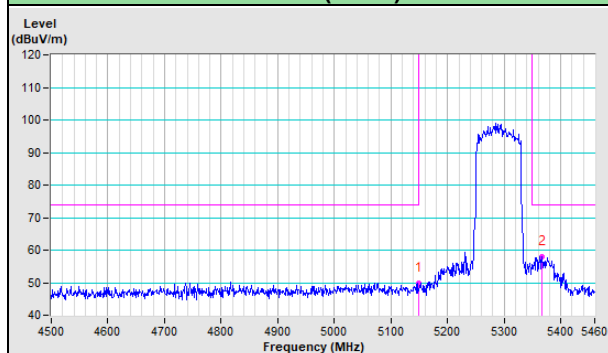

802.11ax (HE80) Channel 106

Horizontal (Peak)

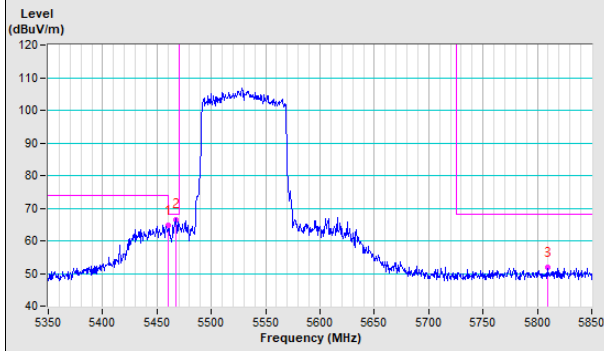

Horizontal (Average)

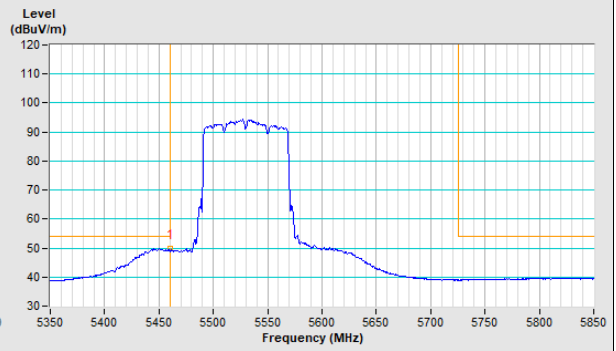

Vertical (Peak)

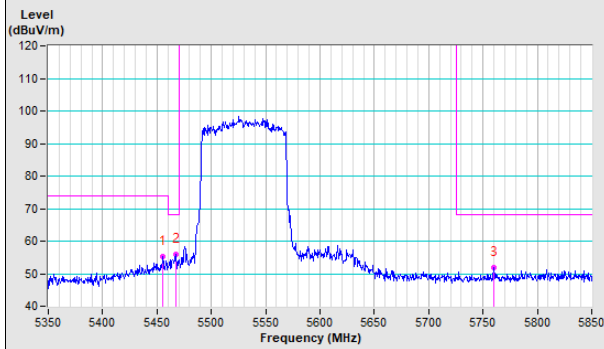

Vertical (Average)

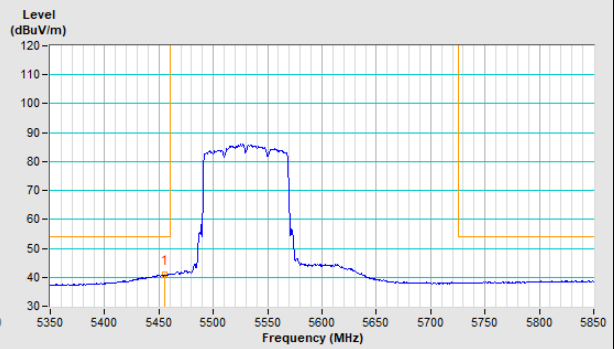

20MHz Preamble 802.11ax (RU26) Channel 36

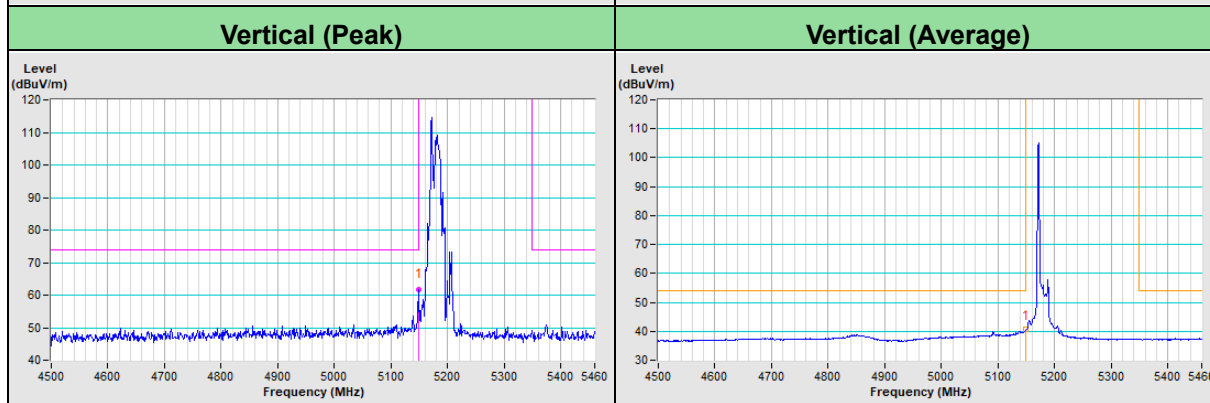
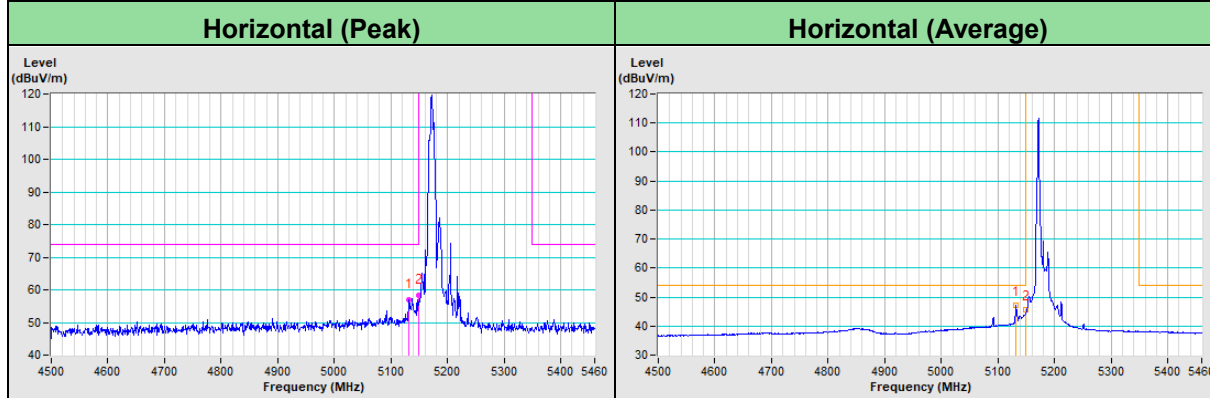

20MHz Preamble 802.11ax (RU26) Channel 64

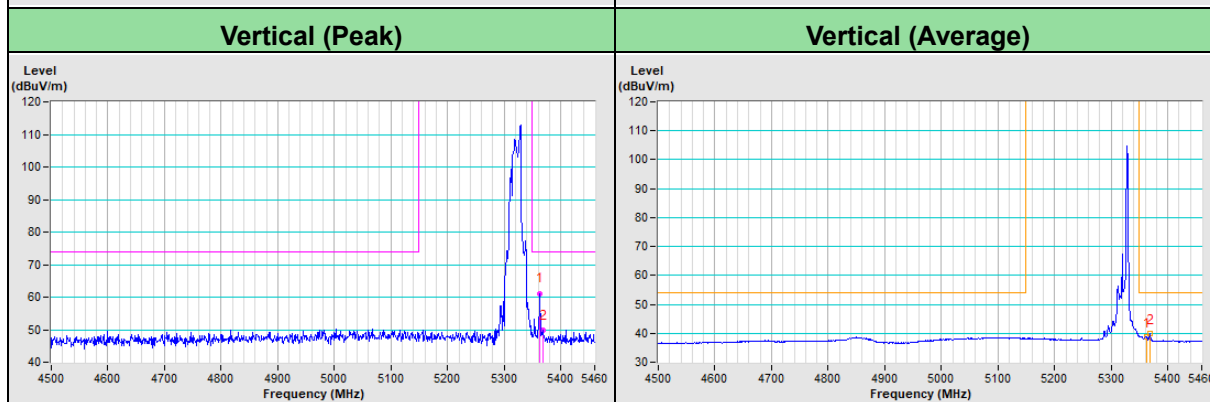
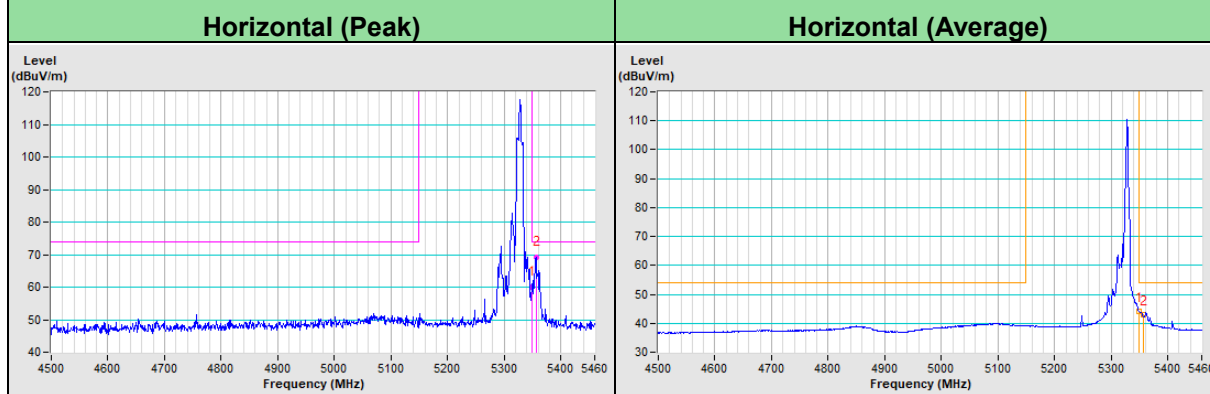

20MHz Preamble 802.11ax (RU26) Channel 100

Horizontal (Peak)

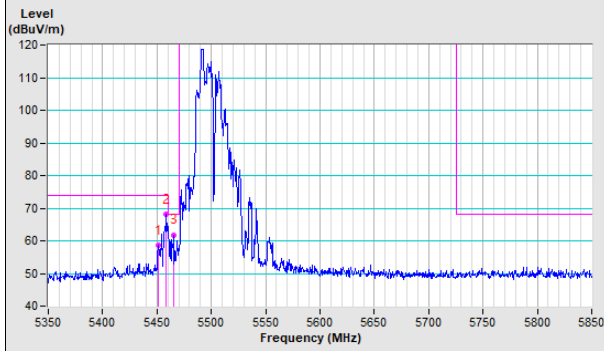

Horizontal (Average)

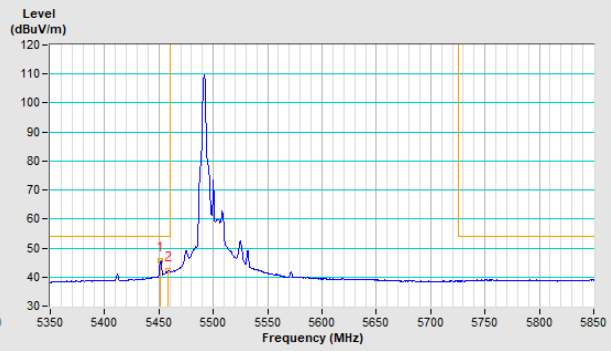

Vertical (Peak)

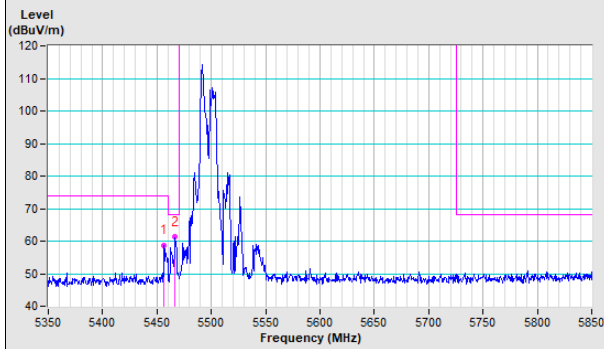

Vertical (Average)

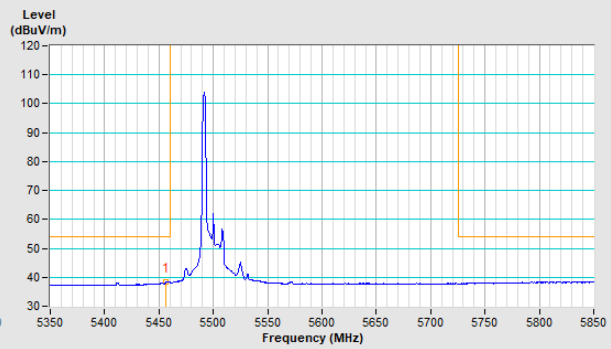

20MHz Preamble 802.11ax (RU52) Channel 36

Horizontal (Peak)

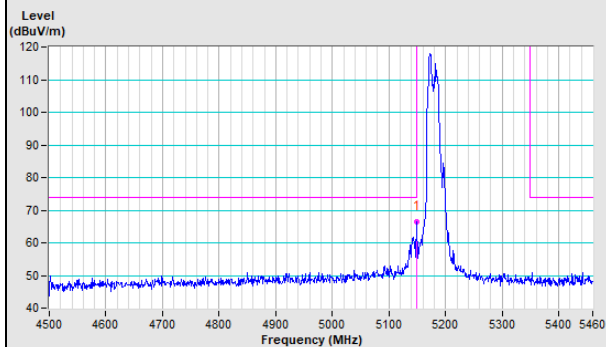

Horizontal (Average)

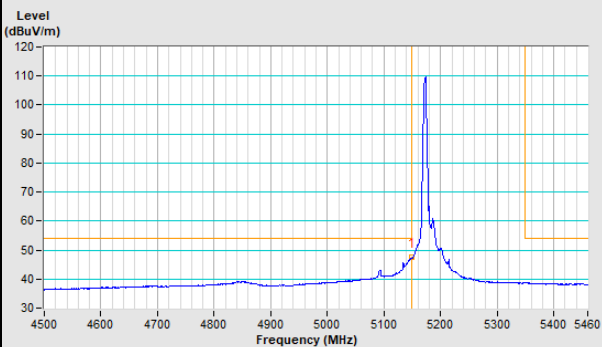

Vertical (Peak)

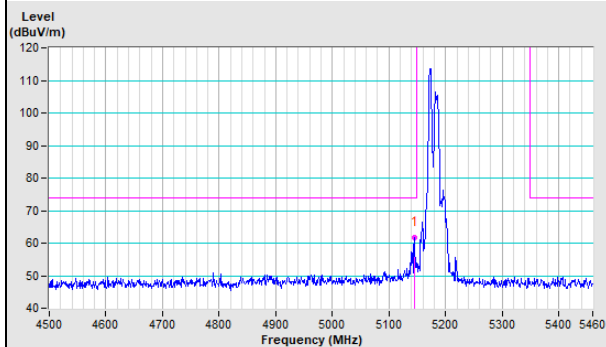

Vertical (Average)

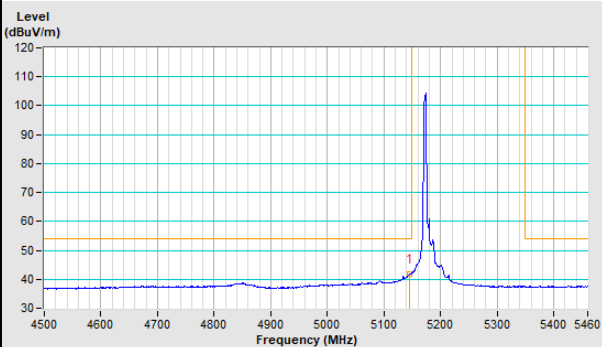

20MHz Preamble 802.11ax (RU52) Channel 64

Horizontal (Peak)

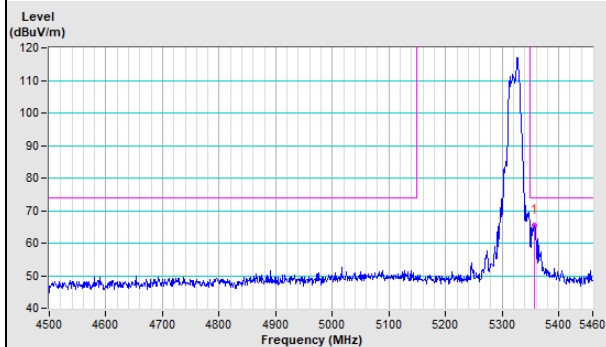

Horizontal (Average)

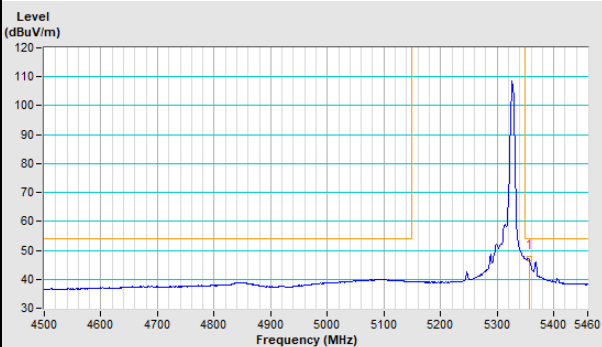

Vertical (Peak)

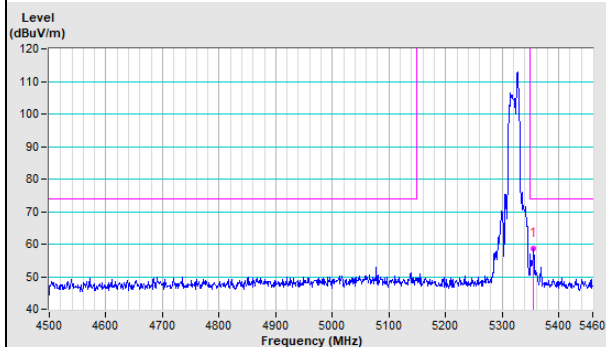

Vertical (Average)

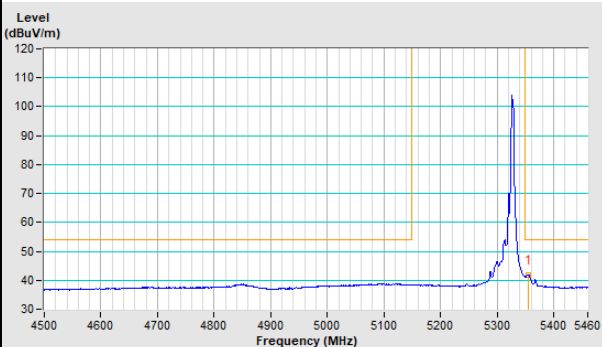

20MHz Preamble 802.11ax (RU52) Channel 100

Horizontal (Peak)

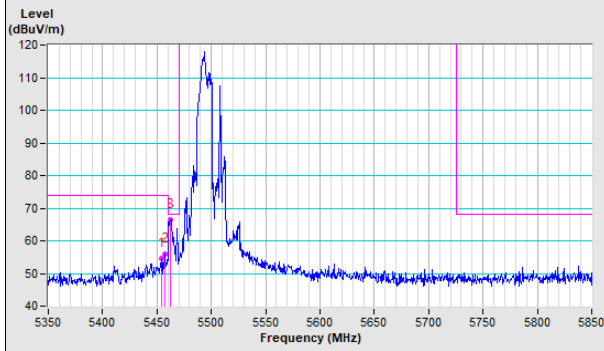

Horizontal (Average)

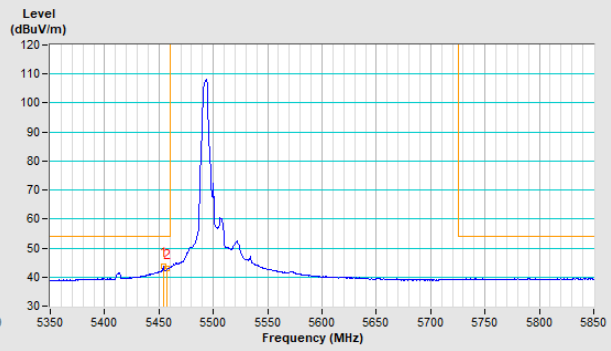

Vertical (Peak)

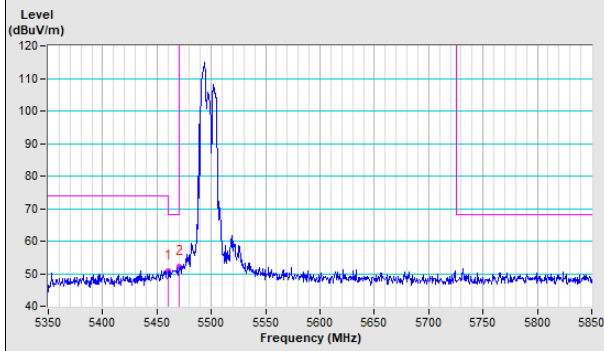

Vertical (Average)

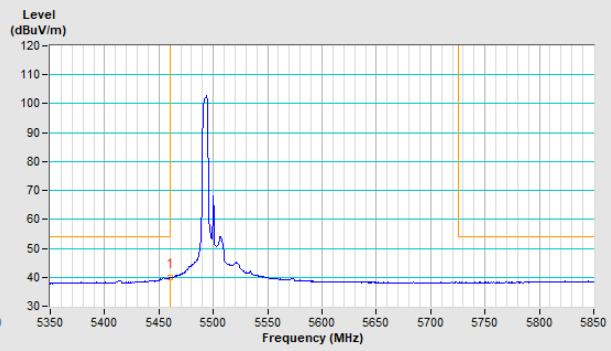

20MHz Preamble 802.11ax (RU106) Channel 36

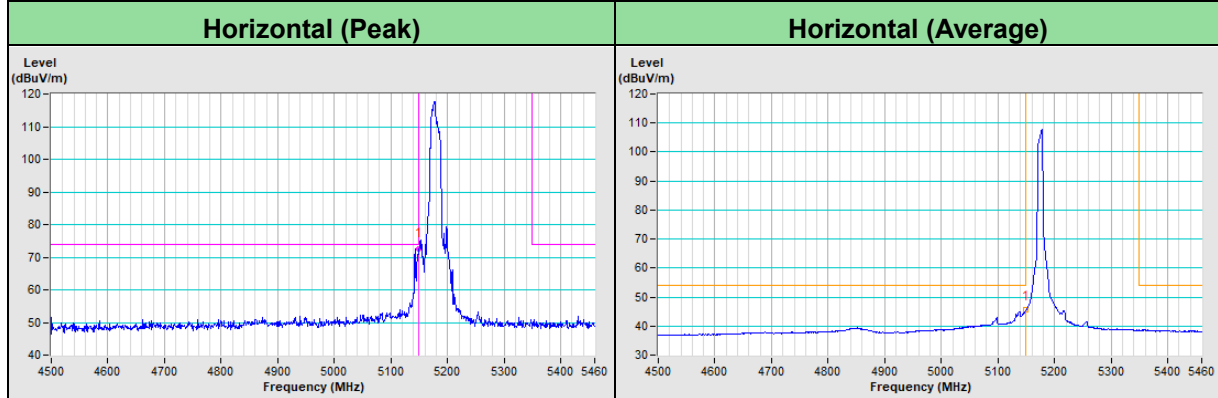

Vertical (Peak)	Vertical (Average)
-----------------	--------------------

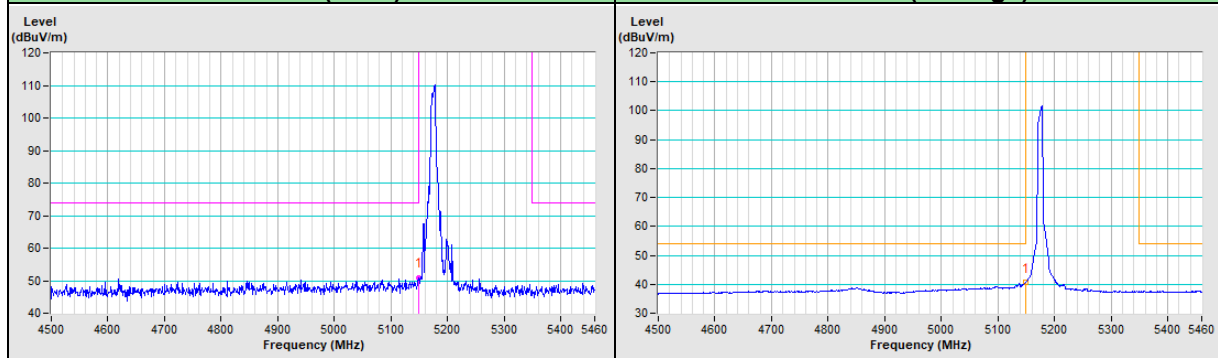

20MHz Preamble 802.11ax (RU106) Channel 64

Horizontal (Peak)	Horizontal (Average)
-------------------	----------------------

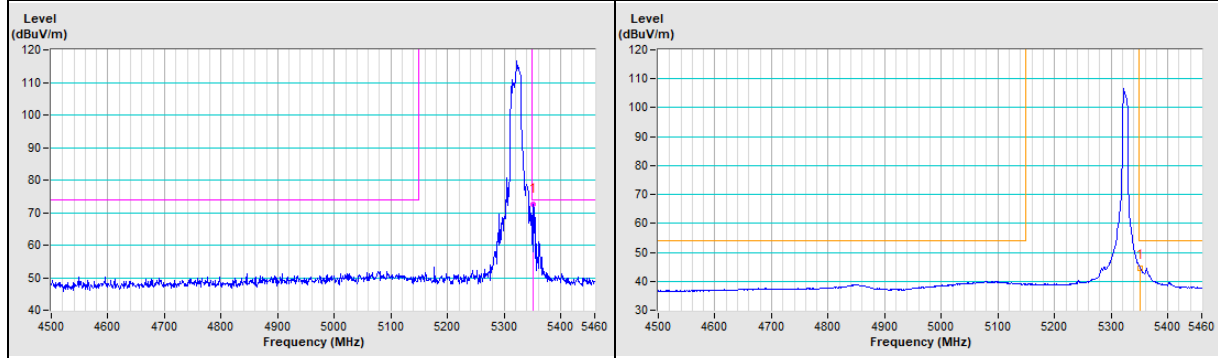

Vertical (Peak)	Vertical (Average)
-----------------	--------------------

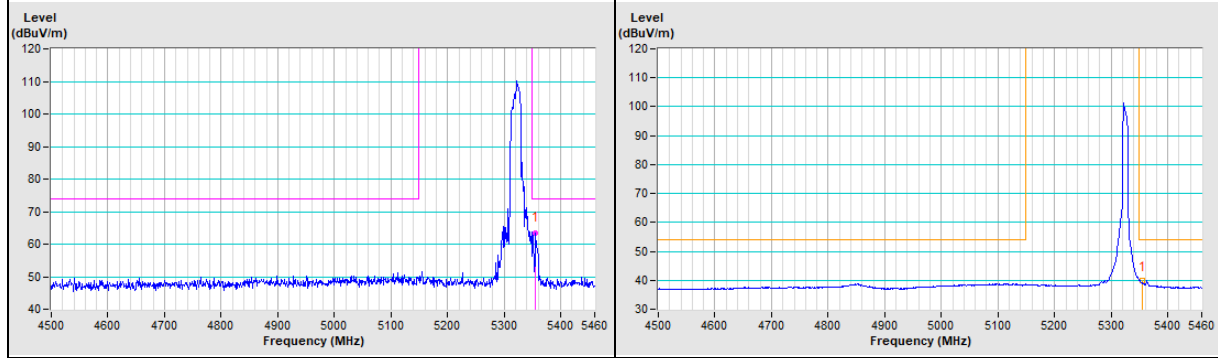

20MHz Preamble 802.11ax (RU106) Channel 100

Horizontal (Peak)

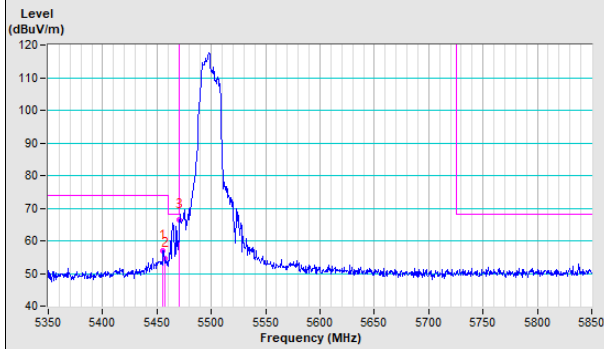

Horizontal (Average)

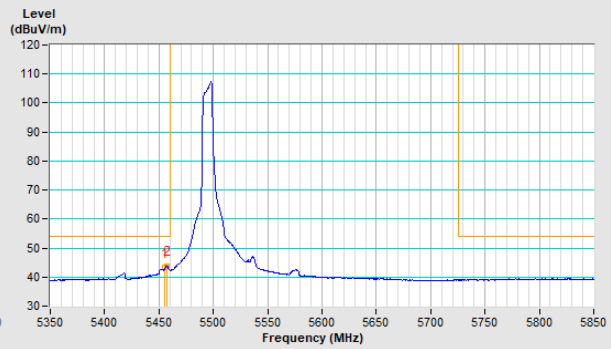

Vertical (Peak)

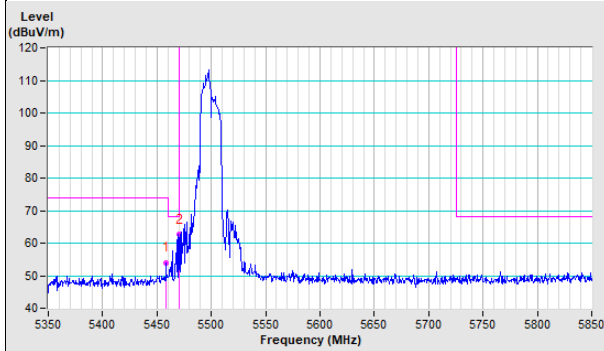

Vertical (Average)

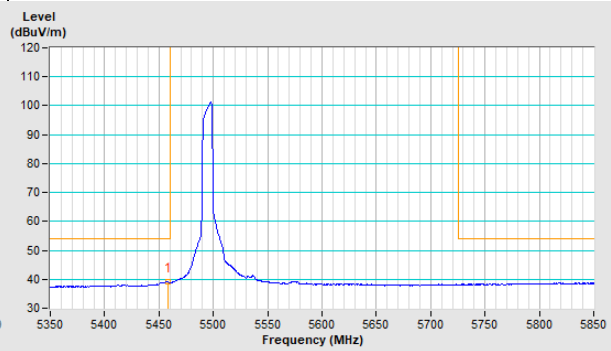

Appendix – Information of the Testing Laboratories

We, Bureau Veritas Consumer Products Services (H.K.) Ltd., Taoyuan Branch, were founded in 1988 to provide our best service in EMC, Radio, Telecom and Safety consultation. Our laboratories are FCC recognized accredited test firms and accredited according to ISO/IEC 17025.

If you have any comments, please feel free to contact us at the following:

Lin Kou EMC/RF Lab

Tel: 886-2-26052180

Fax: 886-2-26051924

Hsin Chu EMC/RF/Telecom Lab

Tel: 886-3-6668565

Fax: 886-3-6668323

Hwa Ya EMC/RF/Safety Lab

Tel: 886-3-3183232

Fax: 886-3-3270892

Email: service.adt@tw.bureauveritas.com

Web Site: www.bureauveritas-adt.com

The address and road map of all our labs can be found in our web site also.

--- END ---