

FCC Test Report (BT-EDR)

Report No.: RFBBUI-WTW-P21040655-2

FCC ID: TX2-RTL8852BE

Test Model: RTL8852BE

Received Date: Apr. 20, 2021

Test Date: June 09 to July 05, 2021

Issued Date: Aug. 02, 2021

Applicant: Realtek Semiconductor Corp.

Address: No. 2, Innovation Road II, Hsinchu Science Park, Hsinchu 300, Taiwan

Issued By: Bureau Veritas Consumer Products Services (H.K.) Ltd., Taoyuan Branch
Hsin Chu Laboratory

Lab Address: E-2, No.1, Li Hsin 1st Road, Hsinchu Science Park, Hsinchu City 300,
Taiwan

Test Location: E-2, No.1, Li Hsin 1st Road, Hsinchu Science Park, Hsinchu City 300,
Taiwan

**FCC Registration /
Designation Number:** 723255 / TW2022



This report is for your exclusive use. Any copying or replication of this report to or for any other person or entity, or use of our name or trademark, is permitted only with our prior written permission. This report sets forth our findings solely with respect to the test samples identified herein. The results set forth in this report are not indicative or representative of the quality or characteristics of the lot from which a test sample was taken or any similar or identical product unless specifically and expressly noted. Our report includes all of the tests requested by you and the results thereof based upon the information that you provided to us. You have 60 days from date of issuance of this report to notify us of any material error or omission caused by our negligence, provided, however, that such notice shall be in writing and shall specifically address the issue you wish to raise. A failure to raise such issue within the prescribed time shall constitute your unqualified acceptance of the completeness of this report, the tests conducted and the correctness of the report contents. Unless specific mention, the uncertainty of measurement has been explicitly taken into account to declare the compliance or non-compliance to the specification.

Table of Contents

Release Control Record	4
1 Certificate of Conformity	5
2 Summary of Test Results	6
2.1 Measurement Uncertainty.....	6
2.2 Modification Record.....	6
3 General Information	7
3.1 General Description of EUT (BT-EDR).....	7
3.2 Description of Test Modes.....	9
3.2.1 Test Mode Applicability and Tested Channel Detail.....	10
3.3 Duty Cycle of Test Signal.....	12
3.4 Description of Support Units.....	13
3.4.1 Configuration of System under Test.....	14
3.5 General Description of Applied Standards and references.....	15
4 Test Types and Results	16
4.1 Radiated Emission and Bandedge Measurement.....	16
4.1.1 Limits of Radiated Emission and Bandedge Measurement.....	16
4.1.2 Test Instruments.....	17
4.1.3 Test Procedures.....	19
4.1.4 Deviation from Test Standard.....	20
4.1.5 Test Setup.....	20
4.1.6 EUT Operating Conditions.....	21
4.1.6 Test Results (Mode 1).....	22
4.1.7 Test Results (Mode 2).....	38
4.2 Conducted Emission Measurement.....	54
4.2.1 Limits of Conducted Emission Measurement.....	54
4.2.2 Test Instruments.....	54
4.2.3 Test Procedures.....	55
4.2.4 Deviation From Test Standard.....	55
4.2.5 Test Setup.....	55
4.2.6 EUT Operating Condition.....	55
4.2.7 Test Results (Mode 1).....	56
4.2.8 Test Results (Mode 2).....	58
4.3 Number of Hopping Frequency Used.....	60
4.3.1 Limits of Hopping Frequency Used Measurement.....	60
4.3.2 Test Setup.....	60
4.3.3 Test Instruments.....	60
4.3.4 Test Procedure.....	60
4.3.5 Deviation from Test Standard.....	60
4.3.6 Test Results (Mode 1).....	61
4.3.7 Test Results (Mode 2).....	62
4.4 Dwell Time on Each Channel.....	63
4.4.1 Limits of Dwell Time on Each Channel Measurement.....	63
4.4.2 Test Setup.....	63
4.4.3 Test Instruments.....	63
4.4.4 Test Procedures.....	63
4.4.5 Deviation from Test Standard.....	63
4.4.6 Test Results (Mode 1).....	64
4.4.7 Test Results (Mode 2).....	68
4.5 Channel Bandwidth.....	72
4.5.1 Limits of Channel Bandwidth Measurement.....	72
4.5.2 Test Setup.....	72
4.5.3 Test Instruments.....	72
4.5.4 Test Procedure.....	72

4.5.5	Deviation from Test Standard	72
4.5.6	EUT Operating Condition	72
4.5.7	Test Results (Mode 1).....	73
4.5.8	Test Results (Mode 2).....	73
4.6	Hopping Channel Separation.....	74
4.6.1	Limits of Hopping Channel Separation Measurement.....	74
4.6.2	Test Setup.....	74
4.6.3	Test Instruments	74
4.6.4	Test Procedure	74
4.6.5	Deviation from Test Standard	74
4.6.6	Test Results (Mode 1).....	75
4.6.7	Test Results (Mode 2).....	76
4.7	Maximum Output Power	77
4.7.1	Limits of Maximum Output Power Measurement	77
4.7.2	Test Setup.....	77
4.7.3	Test Instruments	77
4.7.4	Test Procedure	77
4.7.5	Deviation from Test Standard	77
4.7.6	EUT Operating Condition	77
4.7.7	Test Results (Mode 1).....	78
4.7.8	Test Results (Mode 2).....	78
4.8	Conducted Out of Band Emission Measurement	79
4.8.1	Limits of Conducted Out of Band Emission Measurement	79
4.8.2	Test Instruments	79
4.8.3	Test Procedure	79
4.8.4	Deviation from Test Standard	79
4.8.5	EUT Operating Condition	79
4.8.6	Test Results	79
4.8.7	Test Results (Mode 1).....	80
4.8.8	Test Results (Mode 2).....	82
5	Pictures of Test Arrangements.....	84
	Annex A - Band-Edge Measurement.....	85
	Annex A.1 - Test Results (Mode 1).....	85
	Annex A.2 - Test Results (Mode 2).....	89
	Appendix – Information of the Testing Laboratories	93



Release Control Record

Issue No.	Description	Date Issued
RFBBUI-WTW-P21040655-2	Original release.	Aug. 02, 2021

1 Certificate of Conformity

Product: 11ax RTL8852BE Combo module

Brand: REALTEK

Test Model: RTL8852BE

Sample Status: Engineering sample

Applicant: Realtek Semiconductor Corp.

Test Date: June 09 to July 05, 2021

Standards: 47 CFR FCC Part 15, Subpart C (Section 15.247)
ANSI C63.10: 2013

The above equipment has been tested by **Bureau Veritas Consumer Products Services (H.K.) Ltd., Taoyuan Branch**, and found compliance with the requirement of the above standards. The test record, data evaluation & Equipment Under Test (EUT) configurations represented herein are true and accurate accounts of the measurements of the sample's EMC characteristics under the conditions specified in this report.

Prepared by :



Claire Kuan / Specialist

Date:

Aug. 02, 2021

Approved by :



Clark Lin / Technical Manager

Date:

Aug. 02, 2021

2 Summary of Test Results

47 CFR FCC Part 15, Subpart C (SECTION 15.247)			
FCC Clause	Test Item	Result	Remarks
15.207	AC Power Conducted Emission	PASS	Meet the requirement of limit. Minimum passing margin is -14.42dB at 0.18906 MHz.
15.247(a)(1)(iii)	Number of Hopping Frequency Used	PASS	Meet the requirement of limit.
15.247(a)(1)(iii)	Dwell Time on Each Channel	PASS	Meet the requirement of limit.
15.247(a)(1)	1. Hopping Channel Separation 2. Spectrum Bandwidth of a Frequency Hopping Sequence Spread Spectrum System	PASS	Meet the requirement of limit.
15.247(b)	Maximum Peak Output Power	PASS	Meet the requirement of limit.
15.205 & 209 & 15.247(d)	Radiated Emissions & Band Edge Measurement	PASS	Meet the requirement of limit. Minimum passing margin is -5.1dB at 119.81MHz.
15.247(d)	Antenna Port Emission	PASS	Meet the requirement of limit.
15.203	Antenna Requirement	PASS	Antenna connector is i-pex(MHF) not a standard connector.

NOTE:

1. If The Frequency Hopping System operating in 2400-2483.5MHz band and the output power less than 125mW. The hopping channel carrier frequencies separated by a minimum of 25kHz or two-thirds of the 20dB bandwidth of hopping channel whichever is greater.
2. Determining compliance based on the results of the compliance measurement, not taking into account measurement instrumentation uncertainty.

2.1 Measurement Uncertainty

Where relevant, the following measurement uncertainty levels have been estimated for tests performed on the EUT as specified in CISPR 16-4-2:

Measurement	Frequency	Expanded Uncertainty (k=2) (±)
Conducted Emissions at mains ports	150kHz ~ 30MHz	1.9 dB
Conducted emissions	-	2.5 dB
Radiated Emissions up to 1 GHz	9kHz ~ 30MHz	3.1 dB
	30MHz ~ 1GHz	5.1 dB
Radiated Emissions above 1 GHz	1GHz ~ 18GHz	5.1 dB
	18GHz ~ 40GHz	5.3 dB

2.2 Modification Record

There were no modifications required for compliance.

3 General Information

3.1 General Description of EUT (BT-EDR)

Product	11ax RTL8852BE Combo module
Brand	REALTEK
Test Model	RTL8852BE
Status of EUT	Engineering sample
Power Supply Rating	3.3Vdc from host equipment
Modulation Type	GFSK, $\pi/4$ -DQPSK, 8DPSK
Modulation Technology	FHSS
Transfer Rate	Up to 3Mbps
Operating Frequency	2402MHz ~ 2480MHz
Number of Channel	79
Output Power	17.783 mW
Antenna Type	Refer to Note
Antenna Connector	Refer to Note
Accessory Device	NA
Data Cable Supplied	NA

Note:

1. The EUT has below HW SKU configuration, as below table:

SKU No.	Interface	Description
1	PCIe + USB	Single antenna port
2	PCIe + USB	Dual antenna port
3	PCIe + UART	Dual antenna port

Note: From the above HW SKUs, for conducted emission & radiated below 1GHz the worse case was found in **SKU No.: 3** and other test items the worse case was found in **SKU No.: 2**. Therefore only the test data of the SKU was recorded in this report.

2. Simultaneously transmission condition.

Condition	Technology	
1	WLAN 5GHz	Bluetooth

Note: The emission of the simultaneous operation has been evaluated and no non-compliance was found.

3. The antennas provided to the EUT, please refer to the following table:

Ant. Set	RF Chain No.	Brand	Model	Ant. Net Gain (dBi)	Frequency Range (GHz)	Ant. Type	Connector Type	Cable Length (mm)
1	Chain 0	ARISTOTLE	RFA-27-JP326-MHF4300	3.5	2.4~2.4835	PIFA	i-pex(MHF)	300
				5	5.15~5.85			
				5	5.875~7.125			
	Chain 1	ARISTOTLE	RFA-27-JP326-MHF4300	3.5	2.4~2.4835	PIFA	i-pex(MHF)	300
				5	5.15~5.85			
				5	5.875~7.125			
2	Chain 0	ARISTOTLE	RFA-27-C38H1-MHF4300	3	2.4~2.4835	Dipole	i-pex(MHF)	300
				5	5.15~5.85			
				5	5.875~7.125			
	Chain 1	ARISTOTLE	RFA-27-C38H1-MHF4300	3	2.4~2.4835	Dipole	i-pex(MHF)	300
				5	5.15~5.85			
				5	5.875~7.125			

Note:

1. The Bluetooth technology will fix transmission on Chain 1.
2. Max. gain was selected for the final test, except for the radiated emissions test.
4. The above EUT information is declared by manufacturer and for more detailed features description, please refers to the manufacturer's specifications or user's manual.
5. The above Antenna information is declared by manufacturer and for more detailed features description, please refer to the manufacturer's specifications, the laboratory shall not be held responsible.



3.2 Description of Test Modes

79 channels are provided for BT-EDR mode:

Channel	Freq. (MHz)	Channel	Freq. (MHz)	Channel	Freq. (MHz)	Channel	Freq. (MHz)
0	2402	20	2422	40	2442	60	2462
1	2403	21	2423	41	2443	61	2463
2	2404	22	2424	42	2444	62	2464
3	2405	23	2425	43	2445	63	2465
4	2406	24	2426	44	2446	64	2466
5	2407	25	2427	45	2447	65	2467
6	2408	26	2428	46	2448	66	2468
7	2409	27	2429	47	2449	67	2469
8	2410	28	2430	48	2450	68	2470
9	2411	29	2431	49	2451	69	2471
10	2412	30	2432	50	2452	70	2472
11	2413	31	2433	51	2453	71	2473
12	2414	32	2434	52	2454	72	2474
13	2415	33	2435	53	2455	73	2475
14	2416	34	2436	54	2456	74	2476
15	2417	35	2437	55	2457	75	2477
16	2418	36	2438	56	2458	76	2478
17	2419	37	2439	57	2459	77	2479
18	2420	38	2440	58	2460	78	2480
19	2421	39	2441	59	2461		

3.2.1 Test Mode Applicability and Tested Channel Detail

EUT CONFIGURE MODE	APPLICABLE TO				DESCRIPTION
	RE \geq 1G	RE<1G	PLC	APCM	
1	√	√	√	√	Low power
2	√	√	√	√	High power

Where **RE \geq 1G**: Radiated Emission above 1GHz **RE<1G**: Radiated Emission below 1GHz
PLC: Power Line Conducted Emission **APCM**: Antenna Port Conducted Measurement

Note: The EUT's PIFA antenna had been pre-tested on the positioned of each 3 axis. The worst case was found when positioned on **X-plane**.

Radiated Emission Test (Above 1GHz):

- Pre-Scan has been conducted to determine the worst-case mode from all possible combinations between available modulations, data rates and antenna ports (if EUT with antenna diversity architecture).
- Following channel(s) was (were) selected for the final test as listed below.

AVAILABLE CHANNEL	TESTED CHANNEL	MODULATION TECHNOLOGY	MODULATION TYPE	PACKET TYPE
0 to 78	0, 39, 78	FHSS	GFSK	DH5
0 to 78	0, 39, 78	FHSS	8DPSK	3DH5

Radiated Emission Test (Below 1GHz):

- Pre-Scan has been conducted to determine the worst-case mode from all possible combinations between available modulations, data rates and antenna ports (if EUT with antenna diversity architecture).
- Following channel(s) was (were) selected for the final test as listed below.

AVAILABLE CHANNEL	TESTED CHANNEL	MODULATION TECHNOLOGY	MODULATION TYPE	PACKET TYPE
0 to 78	0	FHSS	GFSK	DH5

Power Line Conducted Emission Test:

- Pre-Scan has been conducted to determine the worst-case mode from all possible combinations between available modulations, data rates and antenna ports (if EUT with antenna diversity architecture).
- Following channel(s) was (were) selected for the final test as listed below.

AVAILABLE CHANNEL	TESTED CHANNEL	MODULATION TECHNOLOGY	MODULATION TYPE	PACKET TYPE
0 to 78	0	FHSS	GFSK	DH5

Antenna Port Conducted Measurement:

- This item includes all test value of each mode, but only includes spectrum plot of worst value of each mode.
- Pre-Scan has been conducted to determine the worst-case mode from all possible combinations between available modulations, data rates and antenna ports (if EUT with antenna diversity architecture).
- Following channel(s) was (were) selected for the final test as listed below.

AVAILABLE CHANNEL	TESTED CHANNEL	MODULATION TECHNOLOGY	MODULATION TYPE	PACKET TYPE
0 to 78	0, 39, 78	FHSS	GFSK	DH5
0 to 78	0, 39, 78	FHSS	8DPSK	3DH5

Test Condition:

APPLICABLE TO	ENVIRONMENTAL CONDITIONS	Input Power (System)	TESTED BY
RE \geq 1G	24deg. C, 66%RH 25deg. C, 67%RH	120Vac, 60Hz	Tom Yang Sampson Chen
RE $<$ 1G	25deg. C, 71%RH	120Vac, 60Hz	Sampson Chen
PLC	25deg. C, 65%RH	120Vac, 60Hz	Sampson Chen
APCM	25deg. C, 60%RH	120Vac, 60Hz	Kevin Ko

3.3 Duty Cycle of Test Signal

GFSK: Duty cycle = 2.877 ms/3.73 ms = 0.771

8DPSK: Duty cycle = 2.88 ms/3.74 ms = 0.77

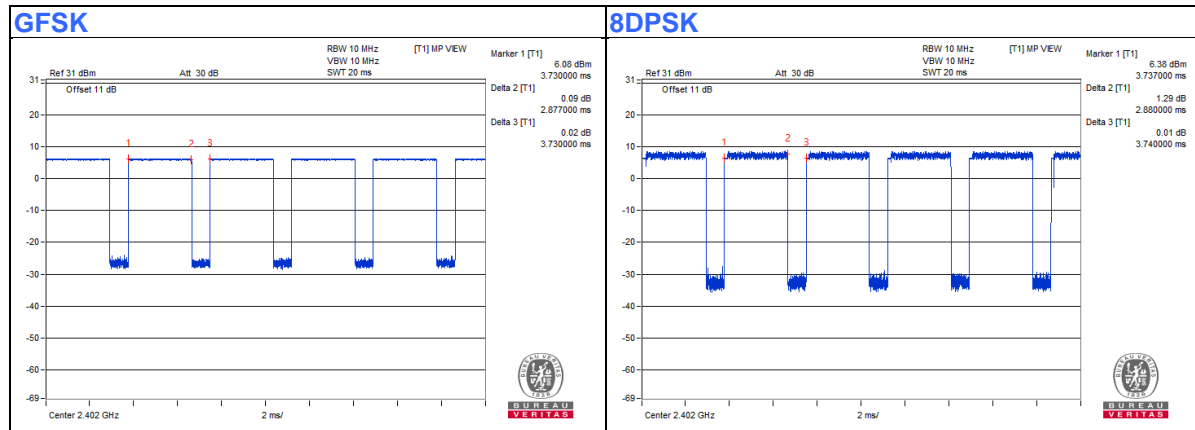

3.4 Description of Support Units

The EUT has been tested as an independent unit together with other necessary accessories or support units. The following support units or accessories were used to form a representative test configuration during the tests.

ID	Product	Brand	Model No.	Serial No.	FCC ID	Remarks
A.	Laptop	DELL	E6420	B92T3R1	NA	Provided by Lab
B.	Test Tool	Realtek	NA	NA	NA	Supplied by client
C.	Adapter	DELL	LA65NS2-01	NA	NA	Provided by Lab

ID	Descriptions	Qty.	Length (m)	Shielding (Yes/No)	Cores (Qty.)	Remarks
1.	DC Cable	1	1.8	No	1	Provided by Lab
2.	AC Cable	1	1	No	0	Provided by Lab

Note: The core is originally attached to the cable.

3.4.1 Configuration of System under Test For AC Power Conducted Emissions test:

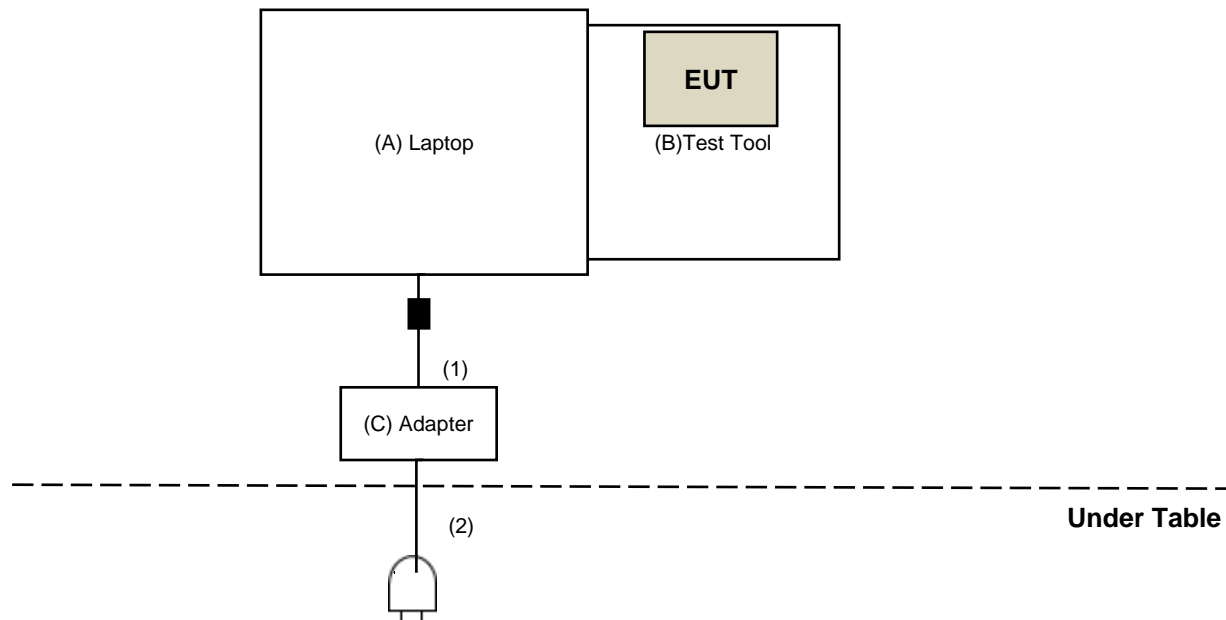

For Radiated Emissions test:

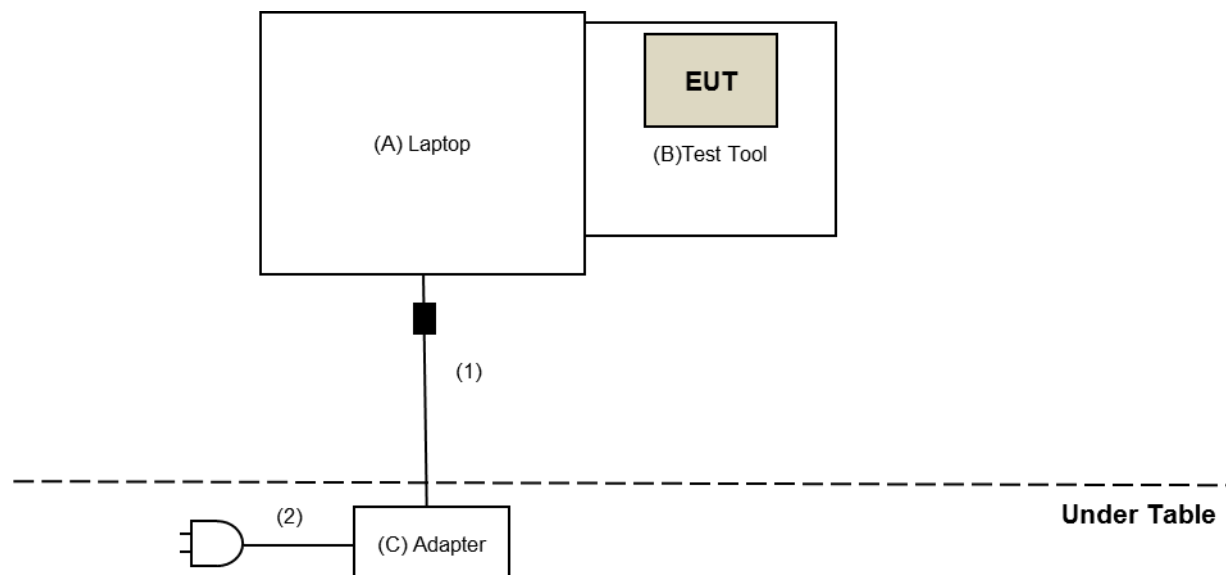

3.5 General Description of Applied Standards and references

The EUT is a RF Product. According to the specifications of the manufacturer, it must comply with the requirements of the following standards and references:

Test standard:

FCC Part 15, Subpart C (15.247)

ANSI C63.10-2013

All test items have been performed and recorded as per the above standards.

References Test Guidance:

KDB 558074 D01 15.247 Meas Guidance v05r02

All test items have been performed as a reference to the above KDB test guidance.

4 Test Types and Results

4.1 Radiated Emission and Bandedge Measurement

4.1.1 Limits of Radiated Emission and Bandedge Measurement

Radiated emissions which fall in the restricted bands must comply with the radiated emission limits specified as below table. Other emissions shall be at least 20dB below the highest level of the desired power:

Frequencies (MHz)	Field Strength (microvolts/meter)	Measurement Distance (meters)
0.009 ~ 0.490	2400/F(kHz)	300
0.490 ~ 1.705	24000/F(kHz)	30
1.705 ~ 30.0	30	30
30 ~ 88	100	3
88 ~ 216	150	3
216 ~ 960	200	3
Above 960	500	3

NOTE:

1. The lower limit shall apply at the transition frequencies.
2. Emission level (dBuV/m) = 20 log Emission level (uV/m).
3. For frequencies above 1000MHz, the field strength limits are based on average detector, however, the peak field strength of any emission shall not exceed the maximum permitted average limits, specified above by more than 20dB under any condition of modulation.

4.1.2 Test Instruments

For Radiated Emission and Bandedge test:

DESCRIPTION & MANUFACTURER	MODEL NO.	SERIAL NO.	CALIBRATED DATE	CALIBRATED UNTIL
Test Receiver R&S	ESR3	102528	Mar. 02, 2021	Mar. 01, 2022
Spectrum Analyzer Keysight	N9030B	MY57141948	May 21, 2021	May 20, 2022
Pre-Amplifier EMCI	EMC001340	980142	May 24, 2021	May 23, 2022
Loop Antenna Electro-Metrics	EM-6879	264	Mar. 05, 2021	Mar. 04, 2022
RF Cable	5D-FB	LOOPCAB-001	Jan. 07, 2021	Jan. 06, 2022
RF Cable	5D-FB	LOOPCAB-002	Jan. 07, 2021	Jan. 06, 2022
Pre-Amplifier EMCI	EMC330N	980538	Apr. 26, 2021	Apr. 25, 2022
Trilog Broadband Antenna SCHWARZBECK	VULB9168	9168-0842	Nov. 03, 2020	Nov. 02, 2021
RF Cable	8D	966-5-1	Apr. 26, 2021	Apr. 25, 2022
RF Cable	8D	966-5-2	Apr. 26, 2021	Apr. 25, 2022
RF Cable	8D	966-5-3	Apr. 26, 2021	Apr. 25, 2022
Fixed attenuator Mini-Circuits	UNAT-5+	PAD-ATT5-02	Jan. 11, 2021	Jan. 10, 2022
Horn_Antenna SCHWARZBECK	BBHA 9120D	9120D-1819	Nov. 22, 2020	Nov. 21, 2021
Pre-Amplifier EMCI	EMC12630SE	980509	Apr. 26, 2021	Apr. 25, 2022
RF Cable EMCI	EMC104-SM-SM-1500	180503	Apr. 26, 2021	Apr. 25, 2022
RF Cable EMCI	EMC104-SM-SM-2000	180501	Apr. 26, 2021	Apr. 25, 2022
RF Cable EMCI	EMC104-SM-SM-6000	180506	Apr. 26, 2021	Apr. 25, 2022
Pre-Amplifier EMCI	EMC184045SE	980387	Jan. 11, 2021	Jan. 10, 2022
Horn_Antenna SCHWARZBECK	BBHA 9170	BBHA9170519	Nov. 22, 2020	Nov. 21, 2021
RF Cable	EMC102-KM-KM-1200	160924	Jan. 11, 2021	Jan. 10, 2022
RF Cable	EMC-KM-KM-4000	200214	Mar. 10, 2021	Mar. 09, 2022
Software	ADT_Radiated_V8.7.08	NA	NA	NA
Boresight Antenna Tower & Turn Table Max-Full	MF-7802BS	MF780208530	NA	NA

Note:

1. The calibration interval of the above test instruments is 12 months and the calibrations are traceable to NML/ROC and NIST/USA.
2. The test was performed in 966 Chamber No. 5.
3. Tested Date: June 09 to July 02, 2021

For other test items:

DESCRIPTION & MANUFACTURER	MODEL NO.	SERIAL NO.	CALIBRATED DATE	CALIBRATED UNTIL
Spectrum Analyzer R&S	FSV40	101516	Mar. 08, 2021	Mar. 07, 2022
Power meter Anritsu	ML2495A	1529002	July 22, 2020	July 21, 2021
Power sensor Anritsu	MA2411B	1339443	May 31, 2021	May 30, 2022
10dB Attenuator Woken	MDCS18N-10	MDCS18N-10-01	Apr. 13, 2021	Apr. 12, 2022
Software	ADT_RF Test Software V6.6.5.4	NA	NA	NA

- NOTE:**
1. The test was performed in Oven room 2.
 2. The calibration interval of the above test instruments is 12 months and the calibrations are traceable to NML/ROC and NIST/USA.
 3. Tested Date: July 05, 2021

4.1.3 Test Procedures

For Radiated emission below 30MHz

- a. The EUT was placed on the top of a rotating table 0.8 meters above the ground at a 3 meter chamber room. The table was rotated 360 degrees to determine the position of the highest radiation.
- b. The EUT was set 3 meters away from the interference-receiving antenna, which was mounted on the top of a variable-height antenna tower.
- c. Both Parallel, perpendicular, and ground-parallel orientations of the antenna are set to make the measurement.
- d. For each suspected emission, the EUT was arranged to its worst case and the rotatable table was turned from 0 degrees to 360 degrees to find the maximum reading.
- e. The test-receiver system was set to Quasi-Peak Detect Function and Specified Bandwidth with Maximum Hold Mode.

NOTE:

1. The resolution bandwidth and video bandwidth of test receiver/spectrum analyzer is 9kHz at frequency below 30MHz.

For Radiated emission above 30MHz

- a. The EUT was placed on the top of a rotating table 0.8 meters (for 30MHz ~ 1GHz) / 1.5 meters (for above 1GHz) above the ground at 3 meter chamber room for test. The table was rotated 360 degrees to determine the position of the highest radiation.
- b. The EUT was set 3 meters away from the interference-receiving antenna, which was mounted on the top of a variable-height antenna tower.
- c. The height of antenna is varied from one meter to four meters above the ground to determine the maximum value of the field strength. Both horizontal and vertical polarizations of the antenna are set to make the measurement.
- d. For each suspected emission, the EUT was arranged to its worst case and then the antenna was tuned to heights from 1 meter to 4 meters and the rotatable table was turned from 0 degrees to 360 degrees to find the maximum reading.
- e. The test-receiver system was set to quasi-peak detect function and specified bandwidth with maximum hold mode when the test frequency is below 1 GHz.
- f. The test-receiver system was set to peak and average detect function and specified bandwidth with maximum hold mode when the test frequency is above 1 GHz. If the peak reading value also meets average limit, measurement with the average detector is unnecessary.

Note:

1. The resolution bandwidth and video bandwidth of test receiver/spectrum analyzer is 120kHz for Quasi-peak detection (QP) at frequency below 1GHz.
2. The resolution bandwidth of test receiver/spectrum analyzer is 1 MHz and the video bandwidth is 3 MHz for Peak detection (PK) at frequency above 1GHz.
3. The resolution bandwidth of test receiver/spectrum analyzer is 1MHz and the video bandwidth is $\geq 1/T$ (Duty cycle < 98%) or 10Hz (Duty cycle $\geq 98\%$) for Average detection (AV) at frequency above 1GHz.
4. All modes of operation were investigated and the worst-case emissions are reported.

4.1.4 Deviation from Test Standard

No deviation.

4.1.5 Test Setup

For Radiated emission below 30MHz

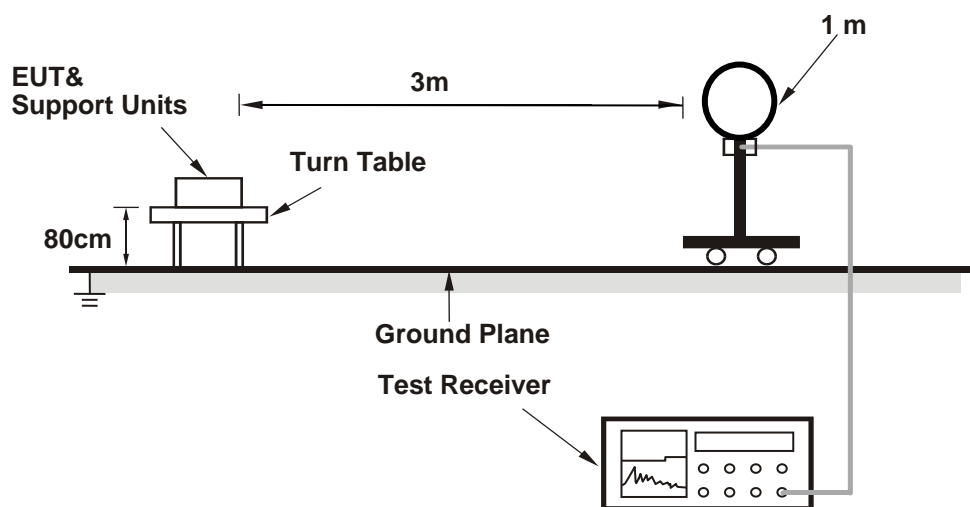

For Radiated emission 30MHz to 1GHz

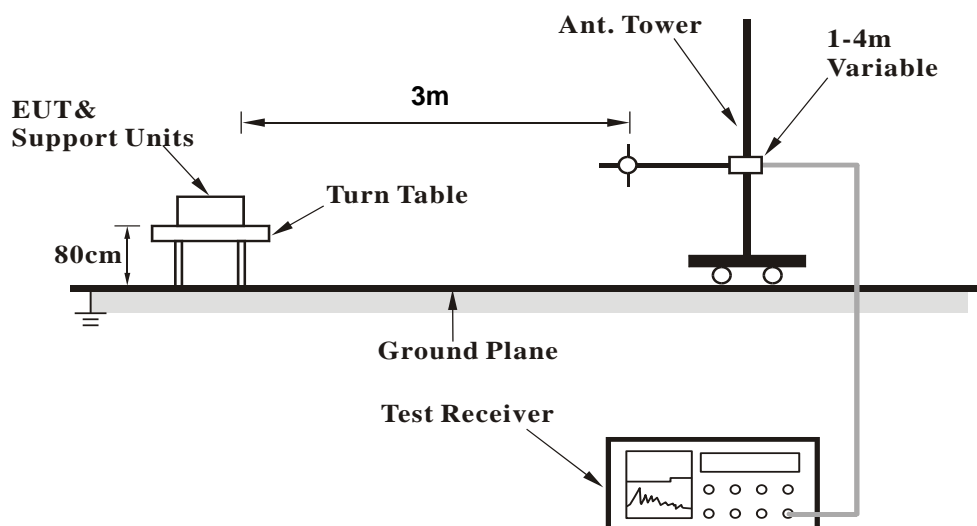

For Radiated emission above 1GHz

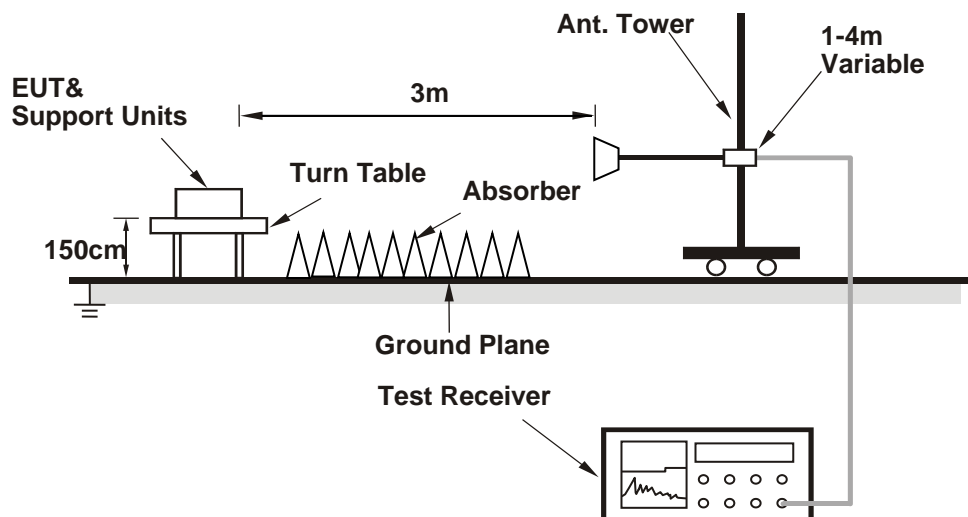

For the actual test configuration, please refer to the attached file (Test Setup Photo).

4.1.6 EUT Operating Conditions

- a. Placed the EUT on the testing table.
- b. Controlling software (Bluetooth RF test tool (5.2.3.1)) has been activated to set the EUT under transmission condition continuously at specific channel frequency.

4.1.6 Test Results (Mode 1)

Dipole Antenna

Above 1GHz Data:

BT_GFSK

RF Mode	TX BT_GFSK	Channel	CH 0 : 2402 MHz
Frequency Range	1GHz ~ 25GHz	Detector Function	Peak (PK) Average (AV)

Antenna Polarity & Test Distance : Horizontal at 3 m								
No	Frequency (MHz)	Emission Level (dBuV/m)	Limit (dBuV/m)	Margin (dB)	Antenna Height (m)	Table Angle (Degree)	Raw Value (dBuV)	Correction Factor (dB/m)
1	2376.05	56.0 PK	74.0	-18.0	1.09 H	142	58.6	-2.6
2	2376.05	43.1 AV	54.0	-10.9	1.09 H	142	45.7	-2.6
3	*2402.00	93.3 PK			1.09 H	142	96.0	-2.7
4	*2402.00	92.9 AV			1.09 H	142	95.6	-2.7
5	4804.00	36.0 PK	74.0	-38.0	1.54 H	171	34.2	1.8
6	4804.00	29.0 AV	54.0	-25.0	1.54 H	171	27.2	1.8

Antenna Polarity & Test Distance : Vertical at 3 m								
No	Frequency (MHz)	Emission Level (dBuV/m)	Limit (dBuV/m)	Margin (dB)	Antenna Height (m)	Table Angle (Degree)	Raw Value (dBuV)	Correction Factor (dB/m)
1	2387.45	55.8 PK	74.0	-18.2	1.59 V	243	58.5	-2.7
2	2387.45	43.5 AV	54.0	-10.5	1.59 V	243	46.2	-2.7
3	*2402.00	103.8 PK			1.59 V	243	106.5	-2.7
4	*2402.00	103.3 AV			1.59 V	243	106.0	-2.7
5	4804.00	42.0 PK	74.0	-32.0	1.29 V	304	40.2	1.8
6	4804.00	34.6 AV	54.0	-19.4	1.29 V	304	32.8	1.8

Remarks:

1. Emission Level(dBuV/m) = Raw Value(dBuV) + Correction Factor(dB/m)
2. Correction Factor(dB/m) = Antenna Factor(dB/m) + Cable Factor(dB) – Pre-Amplifier Factor(dB)
3. Margin value = Emission Level – Limit value
4. The other emission levels were very low against the limit.
5. " * " : Fundamental frequency.

RF Mode	TX BT_GFSK	Channel	CH 39 : 2441 MHz
Frequency Range	1GHz ~ 25GHz	Detector Function	Peak (PK) Average (AV)

Antenna Polarity & Test Distance : Horizontal at 3 m								
No	Frequency (MHz)	Emission Level (dBuV/m)	Limit (dBuV/m)	Margin (dB)	Antenna Height (m)	Table Angle (Degree)	Raw Value (dBuV)	Correction Factor (dB/m)
1	*2441.00	93.3 PK			1.10 H	136	96.0	-2.7
2	*2441.00	93.0 AV			1.10 H	136	95.7	-2.7
3	4882.00	35.9 PK	74.0	-38.1	1.52 H	165	34.2	1.7
4	4882.00	29.2 AV	54.0	-24.8	1.52 H	165	27.5	1.7
5	7323.00	45.9 PK	74.0	-28.1	1.80 H	202	38.6	7.3
6	7323.00	35.6 AV	54.0	-18.4	1.80 H	202	28.3	7.3

Antenna Polarity & Test Distance : Vertical at 3 m								
No	Frequency (MHz)	Emission Level (dBuV/m)	Limit (dBuV/m)	Margin (dB)	Antenna Height (m)	Table Angle (Degree)	Raw Value (dBuV)	Correction Factor (dB/m)
1	*2441.00	104.1 PK			1.54 V	238	106.8	-2.7
2	*2441.00	103.8 AV			1.54 V	238	106.5	-2.7
3	4882.00	42.4 PK	74.0	-31.6	1.24 V	290	40.7	1.7
4	4882.00	35.0 AV	54.0	-19.0	1.24 V	290	33.3	1.7
5	7323.00	49.7 PK	74.0	-24.3	1.48 V	274	42.4	7.3
6	7323.00	41.6 AV	54.0	-12.4	1.48 V	274	34.3	7.3

Remarks:

1. Emission Level(dBuV/m) = Raw Value(dBuV) + Correction Factor(dB/m)
2. Correction Factor(dB/m) = Antenna Factor(dB/m) + Cable Factor(dB) – Pre-Amplifier Factor(dB)
3. Margin value = Emission Level – Limit value
4. The other emission levels were very low against the limit.
5. " * " : Fundamental frequency.

RF Mode	TX BT_GFSK	Channel	CH 78 : 2480 MHz
Frequency Range	1GHz ~ 25GHz	Detector Function	Peak (PK) Average (AV)

Antenna Polarity & Test Distance : Horizontal at 3 m								
No	Frequency (MHz)	Emission Level (dBuV/m)	Limit (dBuV/m)	Margin (dB)	Antenna Height (m)	Table Angle (Degree)	Raw Value (dBuV)	Correction Factor (dB/m)
1	*2480.00	92.3 PK			1.42 H	144	95.1	-2.8
2	*2480.00	91.9 AV			1.42 H	144	94.7	-2.8
3	2493.33	56.0 PK	74.0	-18.0	1.42 H	144	58.8	-2.8
4	2493.33	43.3 AV	54.0	-10.7	1.42 H	144	46.1	-2.8
5	4960.00	35.9 PK	74.0	-38.1	1.47 H	176	33.9	2.0
6	4960.00	29.5 AV	54.0	-24.5	1.47 H	176	27.5	2.0
7	7440.00	45.6 PK	74.0	-28.4	1.85 H	212	38.0	7.6
8	7440.00	35.2 AV	54.0	-18.8	1.85 H	212	27.6	7.6

Antenna Polarity & Test Distance : Vertical at 3 m								
No	Frequency (MHz)	Emission Level (dBuV/m)	Limit (dBuV/m)	Margin (dB)	Antenna Height (m)	Table Angle (Degree)	Raw Value (dBuV)	Correction Factor (dB/m)
1	*2480.00	104.7 PK			1.61 V	247	107.5	-2.8
2	*2480.00	104.2 AV			1.61 V	247	107.0	-2.8
3	2484.34	56.2 PK	74.0	-17.8	1.61 V	247	59.0	-2.8
4	2484.34	43.7 AV	54.0	-10.3	1.61 V	247	46.5	-2.8
5	4960.00	42.3 PK	74.0	-31.7	1.29 V	302	40.3	2.0
6	4960.00	34.8 AV	54.0	-19.2	1.29 V	302	32.8	2.0
7	7440.00	50.1 PK	74.0	-23.9	1.46 V	267	42.5	7.6
8	7440.00	41.9 AV	54.0	-12.1	1.46 V	267	34.3	7.6

Remarks:

1. Emission Level(dBuV/m) = Raw Value(dBuV) + Correction Factor(dB/m)
2. Correction Factor(dB/m) = Antenna Factor(dB/m) + Cable Factor(dB) – Pre-Amplifier Factor(dB)
3. Margin value = Emission Level – Limit value
4. The other emission levels were very low against the limit.
5. " * " : Fundamental frequency.

BT_8DPSK

RF Mode	TX BT_8DPSK	Channel	CH 0 : 2402 MHz
Frequency Range	1GHz ~ 25GHz	Detector Function	Peak (PK) Average (AV)

Antenna Polarity & Test Distance : Horizontal at 3 m								
No	Frequency (MHz)	Emission Level (dBuV/m)	Limit (dBuV/m)	Margin (dB)	Antenna Height (m)	Table Angle (Degree)	Raw Value (dBuV)	Correction Factor (dB/m)
1	2369.90	55.2 PK	74.0	-18.8	1.12 H	139	57.9	-2.7
2	2369.90	43.1 AV	54.0	-10.9	1.12 H	139	45.8	-2.7
3	*2402.00	94.9 PK			1.12 H	139	97.6	-2.7
4	*2402.00	90.7 AV			1.12 H	139	93.4	-2.7
5	4804.00	36.2 PK	74.0	-37.8	1.49 H	155	34.4	1.8
6	4804.00	29.5 AV	54.0	-24.5	1.49 H	155	27.7	1.8
Antenna Polarity & Test Distance : Vertical at 3 m								
No	Frequency (MHz)	Emission Level (dBuV/m)	Limit (dBuV/m)	Margin (dB)	Antenna Height (m)	Table Angle (Degree)	Raw Value (dBuV)	Correction Factor (dB/m)
1	2370.74	56.5 PK	74.0	-17.5	1.63 V	258	59.2	-2.7
2	2370.74	43.3 AV	54.0	-10.7	1.63 V	258	46.0	-2.7
3	*2402.00	105.2 PK			1.63 V	258	107.9	-2.7
4	*2402.00	100.9 AV			1.63 V	258	103.6	-2.7
5	4804.00	42.7 PK	74.0	-31.3	1.20 V	305	40.9	1.8
6	4804.00	35.5 AV	54.0	-18.5	1.20 V	305	33.7	1.8

Remarks:

1. Emission Level(dBuV/m) = Raw Value(dBuV) + Correction Factor(dB/m)
2. Correction Factor(dB/m) = Antenna Factor(dB/m) + Cable Factor(dB) – Pre-Amplifier Factor(dB)
3. Margin value = Emission Level – Limit value
4. The other emission levels were very low against the limit.
5. " * " : Fundamental frequency.

RF Mode	TX BT_8DPSK	Channel	CH 39 : 2441 MHz
Frequency Range	1GHz ~ 25GHz	Detector Function	Peak (PK) Average (AV)

Antenna Polarity & Test Distance : Horizontal at 3 m								
No	Frequency (MHz)	Emission Level (dBuV/m)	Limit (dBuV/m)	Margin (dB)	Antenna Height (m)	Table Angle (Degree)	Raw Value (dBuV)	Correction Factor (dB/m)
1	*2441.00	95.1 PK			1.14 H	142	97.8	-2.7
2	*2441.00	91.0 AV			1.14 H	142	93.7	-2.7
3	4882.00	36.4 PK	74.0	-37.6	1.52 H	165	34.7	1.7
4	4882.00	29.6 AV	54.0	-24.4	1.52 H	165	27.9	1.7
5	7323.00	45.4 PK	74.0	-28.6	1.75 H	187	38.1	7.3
6	7323.00	35.3 AV	54.0	-18.7	1.75 H	187	28.0	7.3

Antenna Polarity & Test Distance : Vertical at 3 m								
No	Frequency (MHz)	Emission Level (dBuV/m)	Limit (dBuV/m)	Margin (dB)	Antenna Height (m)	Table Angle (Degree)	Raw Value (dBuV)	Correction Factor (dB/m)
1	*2441.00	105.3 PK			1.62 V	268	108.0	-2.7
2	*2441.00	101.1 AV			1.62 V	268	103.8	-2.7
3	4882.00	42.4 PK	74.0	-31.6	1.19 V	289	40.7	1.7
4	4882.00	34.8 AV	54.0	-19.2	1.19 V	289	33.1	1.7
5	7323.00	49.7 PK	74.0	-24.3	1.53 V	259	42.4	7.3
6	7323.00	41.3 AV	54.0	-12.7	1.53 V	259	34.0	7.3

Remarks:

1. Emission Level(dBuV/m) = Raw Value(dBuV) + Correction Factor(dB/m)
2. Correction Factor(dB/m) = Antenna Factor(dB/m) + Cable Factor(dB) – Pre-Amplifier Factor(dB)
3. Margin value = Emission Level – Limit value
4. The other emission levels were very low against the limit.
5. " * " : Fundamental frequency.

RF Mode	TX BT_8DPSK	Channel	CH 78 : 2480 MHz
Frequency Range	1GHz ~ 25GHz	Detector Function	Peak (PK) Average (AV)

Antenna Polarity & Test Distance : Horizontal at 3 m								
No	Frequency (MHz)	Emission Level (dBuV/m)	Limit (dBuV/m)	Margin (dB)	Antenna Height (m)	Table Angle (Degree)	Raw Value (dBuV)	Correction Factor (dB/m)
1	*2480.00	93.7 PK			1.47 H	146	96.5	-2.8
2	*2480.00	89.6 AV			1.47 H	146	92.4	-2.8
3	2486.61	55.5 PK	74.0	-18.5	1.47 H	146	58.3	-2.8
4	2486.61	43.2 AV	54.0	-10.8	1.47 H	146	46.0	-2.8
5	4960.00	36.4 PK	74.0	-37.6	1.57 H	174	34.4	2.0
6	4960.00	29.5 AV	54.0	-24.5	1.57 H	174	27.5	2.0
7	7440.00	46.2 PK	74.0	-27.8	1.86 H	199	38.6	7.6
8	7440.00	36.0 AV	54.0	-18.0	1.86 H	199	28.4	7.6

Antenna Polarity & Test Distance : Vertical at 3 m								
No	Frequency (MHz)	Emission Level (dBuV/m)	Limit (dBuV/m)	Margin (dB)	Antenna Height (m)	Table Angle (Degree)	Raw Value (dBuV)	Correction Factor (dB/m)
1	*2480.00	106.1 PK			1.59 V	229	108.9	-2.8
2	*2480.00	101.9 AV			1.59 V	229	104.7	-2.8
3	2483.50	56.1 PK	74.0	-17.9	1.59 V	229	58.9	-2.8
4	2483.50	43.8 AV	54.0	-10.2	1.59 V	229	46.6	-2.8
5	4960.00	41.9 PK	74.0	-32.1	1.19 V	276	39.9	2.0
6	4960.00	34.6 AV	54.0	-19.4	1.19 V	276	32.6	2.0
7	7440.00	49.5 PK	74.0	-24.5	1.53 V	282	41.9	7.6
8	7440.00	41.2 AV	54.0	-12.8	1.53 V	282	33.6	7.6

Remarks:

1. Emission Level(dBuV/m) = Raw Value(dBuV) + Correction Factor(dB/m)
2. Correction Factor(dB/m) = Antenna Factor(dB/m) + Cable Factor(dB) – Pre-Amplifier Factor(dB)
3. Margin value = Emission Level – Limit value
4. The other emission levels were very low against the limit.
5. " * " : Fundamental frequency.

Below 1GHz Data:

GFSK

RF Mode	TX BT_GFSK	Channel	CH 0 : 2402 MHz
Frequency Range	9kHz ~ 1GHz	Detector Function	Quasi-Peak (QP)

Antenna Polarity & Test Distance : Horizontal at 3 m								
No	Frequency (MHz)	Emission Level (dBuV/m)	Limit (dBuV/m)	Margin (dB)	Antenna Height (m)	Table Angle (Degree)	Raw Value (dBuV)	Correction Factor (dB/m)
1	119.53	38.0 QP	43.5	-5.5	3.00 H	335	53.1	-15.1
2	166.46	35.0 QP	43.5	-8.5	2.00 H	163	48.1	-13.1
3	226.27	33.4 QP	46.0	-12.6	2.00 H	111	49.3	-15.9
4	298.60	34.4 QP	46.0	-11.6	1.50 H	91	46.8	-12.4
5	336.42	33.7 QP	46.0	-12.3	1.50 H	342	45.0	-11.3
6	575.23	27.4 QP	46.0	-18.6	1.50 H	130	33.6	-6.2

Remarks:

1. Emission Level(dBuV/m) = Raw Value(dBuV) + Correction Factor(dB/m)
2. Correction Factor(dB/m) = Antenna Factor(dB/m) + Cable Factor(dB) – Pre-Amplifier Factor(dB)
3. Margin value = Emission Level – Limit value
4. The other emission levels were very low against the limit of frequency range 30MHz~1000MHz.
5. The emission levels were very low against the limit of frequency range 9kHz~30MHz: the amplitude of spurious emissions attenuated more than 20 dB below the permissible value to be report.

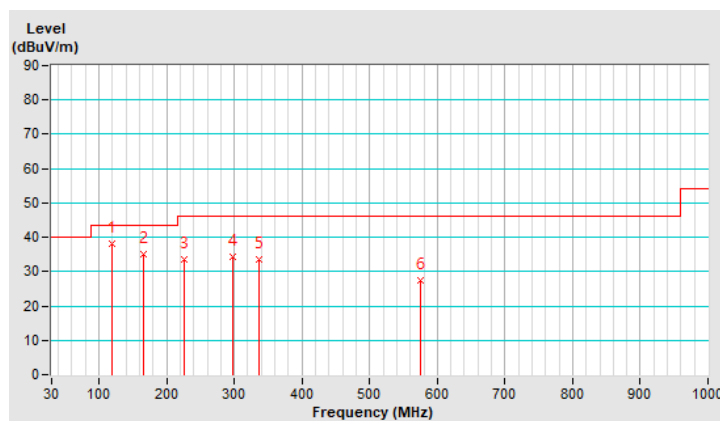

RF Mode	TX BT_GFSK	Channel	CH 0 : 2402 MHz
Frequency Range	9kHz ~ 1GHz	Detector Function	Quasi-Peak (QP)

Antenna Polarity & Test Distance : Vertical at 3 m								
No	Frequency (MHz)	Emission Level (dBuV/m)	Limit (dBuV/m)	Margin (dB)	Antenna Height (m)	Table Angle (Degree)	Raw Value (dBuV)	Correction Factor (dB/m)
1	125.73	29.2 QP	43.5	-14.3	1.00 V	51	43.6	-14.4
2	166.30	31.9 QP	43.5	-11.6	1.50 V	230	45.0	-13.1
3	224.29	31.8 QP	46.0	-14.2	1.00 V	126	47.8	-16.0
4	340.77	26.3 QP	46.0	-19.7	1.50 V	192	37.6	-11.3
5	499.71	25.1 QP	46.0	-20.9	1.50 V	37	32.7	-7.6
6	949.91	32.8 QP	46.0	-13.2	1.00 V	135	33.4	-0.6

Remarks:

1. Emission Level(dBuV/m) = Raw Value(dBuV) + Correction Factor(dB/m)
2. Correction Factor(dB/m) = Antenna Factor(dB/m) + Cable Factor(dB) – Pre-Amplifier Factor(dB)
3. Margin value = Emission Level – Limit value
4. The other emission levels were very low against the limit of frequency range 30MHz~1000MHz.
5. The emission levels were very low against the limit of frequency range 9kHz~30MHz: the amplitude of spurious emissions attenuated more than 20 dB below the permissible value to be report.

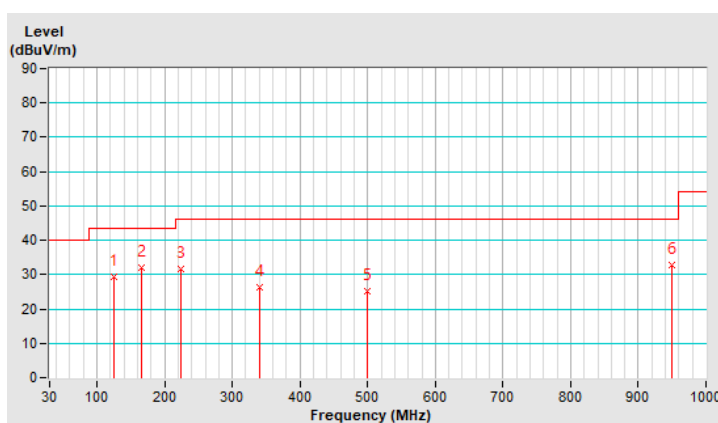

PIFA Antenna

Above 1GHz Data:

BT_GFSK

RF Mode	TX BT_GFSK	Channel	CH 0 : 2402 MHz
Frequency Range	1GHz ~ 25GHz	Detector Function	Peak (PK) Average (AV)

Antenna Polarity & Test Distance : Horizontal at 3 m								
No	Frequency (MHz)	Emission Level (dBuV/m)	Limit (dBuV/m)	Margin (dB)	Antenna Height (m)	Table Angle (Degree)	Raw Value (dBuV)	Correction Factor (dB/m)
1	2385.37	55.6 PK	74.0	-18.4	1.11 H	320	58.3	-2.7
2	2385.37	43.3 AV	54.0	-10.7	1.11 H	320	46.0	-2.7
3	*2402.00	100.5 PK			1.11 H	320	103.2	-2.7
4	*2402.00	100.1 AV			1.11 H	320	102.8	-2.7
5	4804.00	42.0 PK	74.0	-32.0	1.33 H	140	40.2	1.8
6	4804.00	32.3 AV	54.0	-21.7	1.33 H	140	30.5	1.8
Antenna Polarity & Test Distance : Vertical at 3 m								
No	Frequency (MHz)	Emission Level (dBuV/m)	Limit (dBuV/m)	Margin (dB)	Antenna Height (m)	Table Angle (Degree)	Raw Value (dBuV)	Correction Factor (dB/m)
1	2369.40	55.9 PK	74.0	-18.1	2.21 V	89	58.6	-2.7
2	2369.40	43.2 AV	54.0	-10.8	2.21 V	89	45.9	-2.7
3	*2402.00	98.2 PK			2.21 V	89	100.9	-2.7
4	*2402.00	97.9 AV			2.21 V	89	100.6	-2.7
5	4804.00	39.3 PK	74.0	-34.7	1.12 V	103	37.5	1.8
6	4804.00	29.6 AV	54.0	-24.4	1.12 V	103	27.8	1.8

Remarks:

1. Emission Level(dBuV/m) = Raw Value(dBuV) + Correction Factor(dB/m)
2. Correction Factor(dB/m) = Antenna Factor(dB/m) + Cable Factor(dB) – Pre-Amplifier Factor(dB)
3. Margin value = Emission Level – Limit value
4. The other emission levels were very low against the limit.
5. " * " : Fundamental frequency.

RF Mode	TX BT_GFSK	Channel	CH 39 : 2441 MHz
Frequency Range	1GHz ~ 25GHz	Detector Function	Peak (PK) Average (AV)

Antenna Polarity & Test Distance : Horizontal at 3 m								
No	Frequency (MHz)	Emission Level (dBuV/m)	Limit (dBuV/m)	Margin (dB)	Antenna Height (m)	Table Angle (Degree)	Raw Value (dBuV)	Correction Factor (dB/m)
1	*2441.00	100.4 PK			1.02 H	319	103.1	-2.7
2	*2441.00	100.0 AV			1.02 H	319	102.7	-2.7
3	4882.00	41.5 PK	74.0	-32.5	1.39 H	146	39.8	1.7
4	4882.00	31.8 AV	54.0	-22.2	1.39 H	146	30.1	1.7
5	7323.00	51.6 PK	74.0	-22.4	1.49 H	8	44.3	7.3
6	7323.00	42.5 AV	54.0	-11.5	1.49 H	8	35.2	7.3

Antenna Polarity & Test Distance : Vertical at 3 m								
No	Frequency (MHz)	Emission Level (dBuV/m)	Limit (dBuV/m)	Margin (dB)	Antenna Height (m)	Table Angle (Degree)	Raw Value (dBuV)	Correction Factor (dB/m)
1	*2441.00	98.4 PK			2.22 V	85	101.1	-2.7
2	*2441.00	98.0 AV			2.22 V	85	100.7	-2.7
3	4882.00	39.6 PK	74.0	-34.4	1.08 V	104	37.9	1.7
4	4882.00	29.7 AV	54.0	-24.3	1.08 V	104	28.0	1.7
5	7323.00	46.5 PK	74.0	-27.5	3.86 V	353	39.2	7.3
6	7323.00	37.9 AV	54.0	-16.1	3.86 V	353	30.6	7.3

Remarks:

1. Emission Level(dBuV/m) = Raw Value(dBuV) + Correction Factor(dB/m)
2. Correction Factor(dB/m) = Antenna Factor(dB/m) + Cable Factor(dB) – Pre-Amplifier Factor(dB)
3. Margin value = Emission Level – Limit value
4. The other emission levels were very low against the limit.
5. " * " : Fundamental frequency.

RF Mode	TX BT_GFSK	Channel	CH 78 : 2480 MHz
Frequency Range	1GHz ~ 25GHz	Detector Function	Peak (PK) Average (AV)

Antenna Polarity & Test Distance : Horizontal at 3 m								
No	Frequency (MHz)	Emission Level (dBuV/m)	Limit (dBuV/m)	Margin (dB)	Antenna Height (m)	Table Angle (Degree)	Raw Value (dBuV)	Correction Factor (dB/m)
1	*2480.00	100.1 PK			1.07 H	306	102.9	-2.8
2	*2480.00	99.7 AV			1.07 H	306	102.5	-2.8
3	2487.62	55.4 PK	74.0	-18.6	1.07 H	306	58.2	-2.8
4	2487.62	43.3 AV	54.0	-10.7	1.07 H	306	46.1	-2.8
5	4960.00	41.7 PK	74.0	-32.3	1.36 H	154	39.7	2.0
6	4960.00	32.1 AV	54.0	-21.9	1.36 H	154	30.1	2.0
7	7440.00	51.1 PK	74.0	-22.9	1.47 H	1	43.5	7.6
8	7440.00	42.2 AV	54.0	-11.8	1.47 H	1	34.6	7.6

Antenna Polarity & Test Distance : Vertical at 3 m								
No	Frequency (MHz)	Emission Level (dBuV/m)	Limit (dBuV/m)	Margin (dB)	Antenna Height (m)	Table Angle (Degree)	Raw Value (dBuV)	Correction Factor (dB/m)
1	*2480.00	97.8 PK			2.24 V	90	100.6	-2.8
2	*2480.00	97.2 AV			2.24 V	90	100.0	-2.8
3	2494.82	54.7 PK	74.0	-19.3	2.24 V	90	57.5	-2.8
4	2494.82	43.1 AV	54.0	-10.9	2.24 V	90	45.9	-2.8
5	4960.00	40.2 PK	74.0	-33.8	1.05 V	116	38.2	2.0
6	4960.00	30.2 AV	54.0	-23.8	1.05 V	116	28.2	2.0
7	7440.00	46.8 PK	74.0	-27.2	3.87 V	357	39.2	7.6
8	7440.00	38.1 AV	54.0	-15.9	3.87 V	357	30.5	7.6

Remarks:

1. Emission Level(dBuV/m) = Raw Value(dBuV) + Correction Factor(dB/m)
2. Correction Factor(dB/m) = Antenna Factor(dB/m) + Cable Factor(dB) – Pre-Amplifier Factor(dB)
3. Margin value = Emission Level – Limit value
4. The other emission levels were very low against the limit.
5. " * " : Fundamental frequency.

BT_8DPSK

RF Mode	TX BT_8DPSK	Channel	CH 0 : 2402 MHz
Frequency Range	1GHz ~ 25GHz	Detector Function	Peak (PK) Average (AV)

Antenna Polarity & Test Distance : Horizontal at 3 m

No	Frequency (MHz)	Emission Level (dBuV/m)	Limit (dBuV/m)	Margin (dB)	Antenna Height (m)	Table Angle (Degree)	Raw Value (dBuV)	Correction Factor (dB/m)
1	2384.53	55.7 PK	74.0	-18.3	1.14 H	313	58.3	-2.6
2	2384.53	43.0 AV	54.0	-11.0	1.14 H	313	45.6	-2.6
3	*2402.00	101.9 PK			1.14 H	313	104.6	-2.7
4	*2402.00	97.7 AV			1.14 H	313	100.4	-2.7
5	4804.00	41.0 PK	74.0	-33.0	1.41 H	150	39.2	1.8
6	4804.00	31.5 AV	54.0	-22.5	1.41 H	150	29.7	1.8

Antenna Polarity & Test Distance : Vertical at 3 m

No	Frequency (MHz)	Emission Level (dBuV/m)	Limit (dBuV/m)	Margin (dB)	Antenna Height (m)	Table Angle (Degree)	Raw Value (dBuV)	Correction Factor (dB/m)
1	2383.34	56.5 PK	74.0	-17.5	2.20 V	87	59.1	-2.6
2	2383.34	43.3 AV	54.0	-10.7	2.20 V	87	45.9	-2.6
3	*2402.00	99.7 PK			2.20 V	87	102.4	-2.7
4	*2402.00	95.6 AV			2.20 V	87	98.3	-2.7
5	4804.00	39.9 PK	74.0	-34.1	1.13 V	115	38.1	1.8
6	4804.00	29.7 AV	54.0	-24.3	1.13 V	115	27.9	1.8

Remarks:

1. Emission Level(dBuV/m) = Raw Value(dBuV) + Correction Factor(dB/m)
2. Correction Factor(dB/m) = Antenna Factor(dB/m) + Cable Factor(dB) – Pre-Amplifier Factor(dB)
3. Margin value = Emission Level – Limit value
4. The other emission levels were very low against the limit.
5. " * " : Fundamental frequency.

RF Mode	TX BT_8DPSK	Channel	CH 39 : 2441 MHz
Frequency Range	1GHz ~ 25GHz	Detector Function	Peak (PK) Average (AV)

Antenna Polarity & Test Distance : Horizontal at 3 m								
No	Frequency (MHz)	Emission Level (dBuV/m)	Limit (dBuV/m)	Margin (dB)	Antenna Height (m)	Table Angle (Degree)	Raw Value (dBuV)	Correction Factor (dB/m)
1	*2441.00	101.3 PK			1.12 H	299	104.0	-2.7
2	*2441.00	97.4 AV			1.12 H	299	100.1	-2.7
3	4882.00	41.0 PK	74.0	-33.0	1.34 H	146	39.3	1.7
4	4882.00	31.4 AV	54.0	-22.6	1.34 H	146	29.7	1.7
5	7323.00	51.6 PK	74.0	-22.4	1.51 H	11	44.3	7.3
6	7323.00	42.3 AV	54.0	-11.7	1.51 H	11	35.0	7.3

Antenna Polarity & Test Distance : Vertical at 3 m								
No	Frequency (MHz)	Emission Level (dBuV/m)	Limit (dBuV/m)	Margin (dB)	Antenna Height (m)	Table Angle (Degree)	Raw Value (dBuV)	Correction Factor (dB/m)
1	*2441.00	100.0 PK			2.16 V	92	102.7	-2.7
2	*2441.00	95.9 AV			2.16 V	92	98.6	-2.7
3	4882.00	40.2 PK	74.0	-33.8	1.06 V	117	38.5	1.7
4	4882.00	30.2 AV	54.0	-23.8	1.06 V	117	28.5	1.7
5	7323.00	46.8 PK	74.0	-27.2	3.91 V	319	39.5	7.3
6	7323.00	38.0 AV	54.0	-16.0	3.91 V	319	30.7	7.3

Remarks:

1. Emission Level(dBuV/m) = Raw Value(dBuV) + Correction Factor(dB/m)
2. Correction Factor(dB/m) = Antenna Factor(dB/m) + Cable Factor(dB) – Pre-Amplifier Factor(dB)
3. Margin value = Emission Level – Limit value
4. The other emission levels were very low against the limit.
5. " * " : Fundamental frequency.

RF Mode	TX BT_8DPSK	Channel	CH 78 : 2480 MHz
Frequency Range	1GHz ~ 25GHz	Detector Function	Peak (PK) Average (AV)

Antenna Polarity & Test Distance : Horizontal at 3 m								
No	Frequency (MHz)	Emission Level (dBuV/m)	Limit (dBuV/m)	Margin (dB)	Antenna Height (m)	Table Angle (Degree)	Raw Value (dBuV)	Correction Factor (dB/m)
1	*2480.00	101.3 PK			1.15 H	311	104.1	-2.8
2	*2480.00	97.2 AV			1.15 H	311	100.0	-2.8
3	2486.90	54.8 PK	74.0	-19.2	1.15 H	311	57.6	-2.8
4	2486.90	43.3 AV	54.0	-10.7	1.15 H	311	46.1	-2.8
5	4960.00	41.2 PK	74.0	-32.8	1.33 H	157	39.2	2.0
6	4960.00	31.5 AV	54.0	-22.5	1.33 H	157	29.5	2.0
7	7440.00	51.2 PK	74.0	-22.8	1.50 H	18	43.6	7.6
8	7440.00	42.3 AV	54.0	-11.7	1.50 H	18	34.7	7.6

Antenna Polarity & Test Distance : Vertical at 3 m								
No	Frequency (MHz)	Emission Level (dBuV/m)	Limit (dBuV/m)	Margin (dB)	Antenna Height (m)	Table Angle (Degree)	Raw Value (dBuV)	Correction Factor (dB/m)
1	*2480.00	99.5 PK			2.19 V	92	102.3	-2.8
2	*2480.00	95.4 AV			2.19 V	92	98.2	-2.8
3	2484.00	55.3 PK	74.0	-18.7	2.19 V	92	58.1	-2.8
4	2484.00	43.1 AV	54.0	-10.9	2.19 V	92	45.9	-2.8
5	4960.00	39.9 PK	74.0	-34.1	1.09 V	104	37.9	2.0
6	4960.00	29.7 AV	54.0	-24.3	1.09 V	104	27.7	2.0
7	7440.00	46.2 PK	74.0	-27.8	3.82 V	348	38.6	7.6
8	7440.00	37.5 AV	54.0	-16.5	3.82 V	348	29.9	7.6

Remarks:

1. Emission Level(dBuV/m) = Raw Value(dBuV) + Correction Factor(dB/m)
2. Correction Factor(dB/m) = Antenna Factor(dB/m) + Cable Factor(dB) – Pre-Amplifier Factor(dB)
3. Margin value = Emission Level – Limit value
4. The other emission levels were very low against the limit.
5. " * " : Fundamental frequency.

Below 1GHz Data:

BT_GFSK

RF Mode	TX BT_GFSK	Channel	CH 0 : 2402 MHz
Frequency Range	9kHz ~ 1GHz	Detector Function	Quasi-Peak (QP)

Antenna Polarity & Test Distance : Horizontal at 3 m								
No	Frequency (MHz)	Emission Level (dBuV/m)	Limit (dBuV/m)	Margin (dB)	Antenna Height (m)	Table Angle (Degree)	Raw Value (dBuV)	Correction Factor (dB/m)
1	119.67	38.1 QP	43.5	-5.4	3.00 H	345	53.2	-15.1
2	167.41	35.7 QP	43.5	-7.8	2.00 H	148	48.8	-13.1
3	225.82	32.9 QP	46.0	-13.1	2.00 H	129	48.8	-15.9
4	298.99	35.0 QP	46.0	-11.0	1.50 H	78	47.3	-12.3
5	336.40	33.5 QP	46.0	-12.5	1.50 H	318	44.8	-11.3
6	574.23	26.3 QP	46.0	-19.7	1.50 H	126	32.5	-6.2

Remarks:

1. Emission Level(dBuV/m) = Raw Value(dBuV) + Correction Factor(dB/m)
2. Correction Factor(dB/m) = Antenna Factor(dB/m) + Cable Factor(dB) – Pre-Amplifier Factor(dB)
3. Margin value = Emission Level – Limit value
4. The other emission levels were very low against the limit of frequency range 30MHz~1000MHz.
5. The emission levels were very low against the limit of frequency range 9kHz~30MHz: the amplitude of spurious emissions attenuated more than 20 dB below the permissible value to be report.

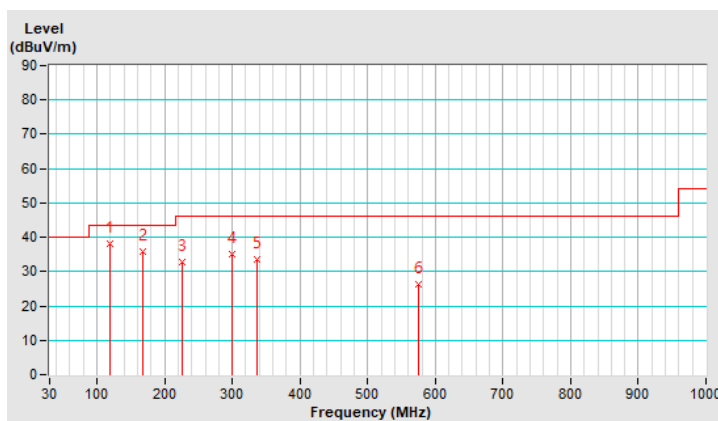

RF Mode	TX BT_GFSK	Channel	CH 0 : 2402 MHz
Frequency Range	9kHz ~ 1GHz	Detector Function	Quasi-Peak (QP)

Antenna Polarity & Test Distance : Vertical at 3 m								
No	Frequency (MHz)	Emission Level (dBuV/m)	Limit (dBuV/m)	Margin (dB)	Antenna Height (m)	Table Angle (Degree)	Raw Value (dBuV)	Correction Factor (dB/m)
1	126.01	29.2 QP	43.5	-14.3	1.00 V	46	43.6	-14.4
2	167.25	32.5 QP	43.5	-11.0	1.50 V	239	45.6	-13.1
3	223.93	31.6 QP	46.0	-14.4	1.00 V	124	47.6	-16.0
4	340.13	25.7 QP	46.0	-20.3	1.50 V	180	37.0	-11.3
5	498.48	24.5 QP	46.0	-21.5	1.50 V	33	32.2	-7.7
6	950.70	33.5 QP	46.0	-12.5	1.00 V	151	34.1	-0.6

Remarks:

1. Emission Level(dBuV/m) = Raw Value(dBuV) + Correction Factor(dB/m)
2. Correction Factor(dB/m) = Antenna Factor(dB/m) + Cable Factor(dB) – Pre-Amplifier Factor(dB)
3. Margin value = Emission Level – Limit value
4. The other emission levels were very low against the limit of frequency range 30MHz~1000MHz.
5. The emission levels were very low against the limit of frequency range 9kHz~30MHz: the amplitude of spurious emissions attenuated more than 20 dB below the permissible value to be report.

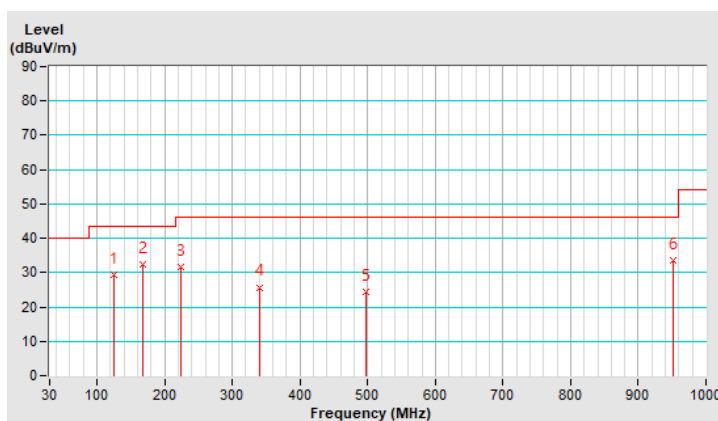

4.1.7 Test Results (Mode 2)

Dipole Antenna

Above 1GHz Data:

BT_GFSK

RF Mode	TX BT_GFSK	Channel	CH 0 : 2402 MHz
Frequency Range	1GHz ~ 25GHz	Detector Function	Peak (PK) Average (AV)

Antenna Polarity & Test Distance : Horizontal at 3 m								
No	Frequency (MHz)	Emission Level (dBuV/m)	Limit (dBuV/m)	Margin (dB)	Antenna Height (m)	Table Angle (Degree)	Raw Value (dBuV)	Correction Factor (dB/m)
1	2380.80	55.8 PK	74.0	-18.2	1.24 H	119	58.4	-2.6
2	2380.80	43.2 AV	54.0	-10.8	1.24 H	119	45.8	-2.6
3	*2402.00	99.5 PK			1.24 H	119	102.2	-2.7
4	*2402.00	99.0 AV			1.24 H	119	101.7	-2.7
5	4804.00	37.2 PK	74.0	-36.8	1.53 H	135	35.4	1.8
6	4804.00	30.1 AV	54.0	-23.9	1.53 H	135	28.3	1.8

Antenna Polarity & Test Distance : Vertical at 3 m								
No	Frequency (MHz)	Emission Level (dBuV/m)	Limit (dBuV/m)	Margin (dB)	Antenna Height (m)	Table Angle (Degree)	Raw Value (dBuV)	Correction Factor (dB/m)
1	2377.15	55.7 PK	74.0	-18.3	1.57 V	307	58.3	-2.6
2	2377.15	43.6 AV	54.0	-10.4	1.57 V	307	46.2	-2.6
3	*2402.00	109.8 PK			1.57 V	307	112.5	-2.7
4	*2402.00	109.4 AV			1.57 V	307	112.1	-2.7
5	4804.00	43.0 PK	74.0	-31.0	1.22 V	294	41.2	1.8
6	4804.00	36.2 AV	54.0	-17.8	1.22 V	294	34.4	1.8

Remarks:

1. Emission Level(dBuV/m) = Raw Value(dBuV) + Correction Factor(dB/m)
2. Correction Factor(dB/m) = Antenna Factor(dB/m) + Cable Factor(dB) – Pre-Amplifier Factor(dB)
3. Margin value = Emission Level – Limit value
4. The other emission levels were very low against the limit.
5. " * " : Fundamental frequency.

RF Mode	TX BT_GFSK	Channel	CH 39 : 2441 MHz
Frequency Range	1GHz ~ 25GHz	Detector Function	Peak (PK) Average (AV)

Antenna Polarity & Test Distance : Horizontal at 3 m								
No	Frequency (MHz)	Emission Level (dBuV/m)	Limit (dBuV/m)	Margin (dB)	Antenna Height (m)	Table Angle (Degree)	Raw Value (dBuV)	Correction Factor (dB/m)
1	*2441.00	100.5 PK			1.42 H	100	103.2	-2.7
2	*2441.00	99.8 AV			1.42 H	100	102.5	-2.7
3	4882.00	37.6 PK	74.0	-36.4	1.52 H	143	35.9	1.7
4	4882.00	30.5 AV	54.0	-23.5	1.52 H	143	28.8	1.7
5	7323.00	48.0 PK	74.0	-26.0	1.77 H	196	40.7	7.3
6	7323.00	37.7 AV	54.0	-16.3	1.77 H	196	30.4	7.3

Antenna Polarity & Test Distance : Vertical at 3 m								
No	Frequency (MHz)	Emission Level (dBuV/m)	Limit (dBuV/m)	Margin (dB)	Antenna Height (m)	Table Angle (Degree)	Raw Value (dBuV)	Correction Factor (dB/m)
1	*2441.00	109.4 PK			1.58 V	311	112.1	-2.7
2	*2441.00	109.2 AV			1.58 V	311	111.9	-2.7
3	4882.00	43.3 PK	74.0	-30.7	1.27 V	300	41.6	1.7
4	4882.00	36.3 AV	54.0	-17.7	1.27 V	300	34.6	1.7
5	7323.00	51.8 PK	74.0	-22.2	1.60 V	268	44.5	7.3
6	7323.00	43.8 AV	54.0	-10.2	1.60 V	268	36.5	7.3

Remarks:

1. Emission Level(dBuV/m) = Raw Value(dBuV) + Correction Factor(dB/m)
2. Correction Factor(dB/m) = Antenna Factor(dB/m) + Cable Factor(dB) – Pre-Amplifier Factor(dB)
3. Margin value = Emission Level – Limit value
4. The other emission levels were very low against the limit.
5. " * " : Fundamental frequency.

RF Mode	TX BT_GFSK	Channel	CH 78 : 2480 MHz
Frequency Range	1GHz ~ 25GHz	Detector Function	Peak (PK) Average (AV)

Antenna Polarity & Test Distance : Horizontal at 3 m								
No	Frequency (MHz)	Emission Level (dBuV/m)	Limit (dBuV/m)	Margin (dB)	Antenna Height (m)	Table Angle (Degree)	Raw Value (dBuV)	Correction Factor (dB/m)
1	*2480.00	100.0 PK			1.41 H	115	102.8	-2.8
2	*2480.00	99.5 AV			1.41 H	115	102.3	-2.8
3	2484.55	55.8 PK	74.0	-18.2	1.41 H	115	58.6	-2.8
4	2484.55	43.2 AV	54.0	-10.8	1.41 H	115	46.0	-2.8
5	4960.00	37.8 PK	74.0	-36.2	1.52 H	131	35.8	2.0
6	4960.00	30.7 AV	54.0	-23.3	1.52 H	131	28.7	2.0
7	7440.00	48.6 PK	74.0	-25.4	1.80 H	183	41.0	7.6
8	7440.00	38.1 AV	54.0	-15.9	1.80 H	183	30.5	7.6

Antenna Polarity & Test Distance : Vertical at 3 m								
No	Frequency (MHz)	Emission Level (dBuV/m)	Limit (dBuV/m)	Margin (dB)	Antenna Height (m)	Table Angle (Degree)	Raw Value (dBuV)	Correction Factor (dB/m)
1	*2480.00	109.1 PK			1.62 V	307	111.9	-2.8
2	*2480.00	109.0 AV			1.62 V	307	111.8	-2.8
3	2483.90	56.8 PK	74.0	-17.2	1.62 V	307	59.6	-2.8
4	2483.90	44.4 AV	54.0	-9.6	1.62 V	307	47.2	-2.8
5	4960.00	43.5 PK	74.0	-30.5	1.22 V	313	41.5	2.0
6	4960.00	36.7 AV	54.0	-17.3	1.22 V	313	34.7	2.0
7	7440.00	51.8 PK	74.0	-22.2	1.63 V	272	44.2	7.6
8	7440.00	43.9 AV	54.0	-10.1	1.63 V	272	36.3	7.6

Remarks:

1. Emission Level(dBuV/m) = Raw Value(dBuV) + Correction Factor(dB/m)
2. Correction Factor(dB/m) = Antenna Factor(dB/m) + Cable Factor(dB) – Pre-Amplifier Factor(dB)
3. Margin value = Emission Level – Limit value
4. The other emission levels were very low against the limit.
5. " * " : Fundamental frequency.

BT_8DPSK

RF Mode	TX BT_8DPSK	Channel	CH 0 : 2402 MHz
Frequency Range	1GHz ~ 25GHz	Detector Function	Peak (PK) Average (AV)

Antenna Polarity & Test Distance : Horizontal at 3 m								
No	Frequency (MHz)	Emission Level (dBuV/m)	Limit (dBuV/m)	Margin (dB)	Antenna Height (m)	Table Angle (Degree)	Raw Value (dBuV)	Correction Factor (dB/m)
1	2382.60	55.5 PK	74.0	-18.5	1.00 H	146	58.1	-2.6
2	2382.60	43.3 AV	54.0	-10.7	1.00 H	146	45.9	-2.6
3	*2402.00	100.9 PK			1.00 H	146	103.6	-2.7
4	*2402.00	97.2 AV			1.00 H	146	99.9	-2.7
5	4804.00	37.9 PK	74.0	-36.1	1.49 H	153	36.1	1.8
6	4804.00	30.8 AV	54.0	-23.2	1.49 H	153	29.0	1.8

Antenna Polarity & Test Distance : Vertical at 3 m								
No	Frequency (MHz)	Emission Level (dBuV/m)	Limit (dBuV/m)	Margin (dB)	Antenna Height (m)	Table Angle (Degree)	Raw Value (dBuV)	Correction Factor (dB/m)
1	2388.87	56.1 PK	74.0	-17.9	1.56 V	234	58.8	-2.7
2	2388.87	43.4 AV	54.0	-10.6	1.56 V	234	46.1	-2.7
3	*2402.00	110.1 PK			1.56 V	234	112.8	-2.7
4	*2402.00	106.5 AV			1.56 V	234	109.2	-2.7
5	4804.00	43.9 PK	74.0	-30.1	1.24 V	287	42.1	1.8
6	4804.00	36.6 AV	54.0	-17.4	1.24 V	287	34.8	1.8

Remarks:

1. Emission Level(dBuV/m) = Raw Value(dBuV) + Correction Factor(dB/m)
2. Correction Factor(dB/m) = Antenna Factor(dB/m) + Cable Factor(dB) – Pre-Amplifier Factor(dB)
3. Margin value = Emission Level – Limit value
4. The other emission levels were very low against the limit.
5. " * " : Fundamental frequency.

RF Mode	TX BT_8DPSK	Channel	CH 39 : 2441 MHz
Frequency Range	1GHz ~ 25GHz	Detector Function	Peak (PK) Average (AV)

Antenna Polarity & Test Distance : Horizontal at 3 m								
No	Frequency (MHz)	Emission Level (dBuV/m)	Limit (dBuV/m)	Margin (dB)	Antenna Height (m)	Table Angle (Degree)	Raw Value (dBuV)	Correction Factor (dB/m)
1	*2441.00	99.8 PK			1.45 H	138	102.5	-2.7
2	*2441.00	96.2 AV			1.45 H	138	98.9	-2.7
3	4882.00	37.3 PK	74.0	-36.7	1.50 H	138	35.6	1.7
4	4882.00	30.3 AV	54.0	-23.7	1.50 H	138	28.6	1.7
5	7323.00	47.7 PK	74.0	-26.3	1.77 H	196	40.4	7.3
6	7323.00	37.5 AV	54.0	-16.5	1.77 H	196	30.2	7.3

Antenna Polarity & Test Distance : Vertical at 3 m								
No	Frequency (MHz)	Emission Level (dBuV/m)	Limit (dBuV/m)	Margin (dB)	Antenna Height (m)	Table Angle (Degree)	Raw Value (dBuV)	Correction Factor (dB/m)
1	*2441.00	109.5 PK			1.59 V	246	112.2	-2.7
2	*2441.00	105.7 AV			1.59 V	246	108.4	-2.7
3	4882.00	43.7 PK	74.0	-30.3	1.28 V	309	42.0	1.7
4	4882.00	36.5 AV	54.0	-17.5	1.28 V	309	34.8	1.7
5	7323.00	52.3 PK	74.0	-21.7	1.60 V	272	45.0	7.3
6	7323.00	44.0 AV	54.0	-10.0	1.60 V	272	36.7	7.3

Remarks:

1. Emission Level(dBuV/m) = Raw Value(dBuV) + Correction Factor(dB/m)
2. Correction Factor(dB/m) = Antenna Factor(dB/m) + Cable Factor(dB) – Pre-Amplifier Factor(dB)
3. Margin value = Emission Level – Limit value
4. The other emission levels were very low against the limit.
5. " * " : Fundamental frequency.

RF Mode	TX BT_8DPSK	Channel	CH 78 : 2480 MHz
Frequency Range	1GHz ~ 25GHz	Detector Function	Peak (PK) Average (AV)

Antenna Polarity & Test Distance : Horizontal at 3 m								
No	Frequency (MHz)	Emission Level (dBuV/m)	Limit (dBuV/m)	Margin (dB)	Antenna Height (m)	Table Angle (Degree)	Raw Value (dBuV)	Correction Factor (dB/m)
1	*2480.00	99.5 PK			1.44 H	150	102.3	-2.8
2	*2480.00	96.1 AV			1.44 H	150	98.9	-2.8
3	2487.50	55.9 PK	74.0	-18.1	1.44 H	150	58.7	-2.8
4	2487.50	43.1 AV	54.0	-10.9	1.44 H	150	45.9	-2.8
5	4960.00	37.3 PK	74.0	-36.7	1.58 H	131	35.3	2.0
6	4960.00	30.2 AV	54.0	-23.8	1.58 H	131	28.2	2.0
7	7440.00	48.6 PK	74.0	-25.4	1.81 H	203	41.0	7.6
8	7440.00	38.1 AV	54.0	-15.9	1.81 H	203	30.5	7.6

Antenna Polarity & Test Distance : Vertical at 3 m								
No	Frequency (MHz)	Emission Level (dBuV/m)	Limit (dBuV/m)	Margin (dB)	Antenna Height (m)	Table Angle (Degree)	Raw Value (dBuV)	Correction Factor (dB/m)
1	*2480.00	109.2 PK			1.58 V	230	112.0	-2.8
2	*2480.00	105.3 AV			1.58 V	230	108.1	-2.8
3	2483.50	55.8 PK	74.0	-18.2	1.58 V	230	58.6	-2.8
4	2483.50	44.5 AV	54.0	-9.5	1.58 V	230	47.3	-2.8
5	4960.00	43.2 PK	74.0	-30.8	1.26 V	302	41.2	2.0
6	4960.00	36.3 AV	54.0	-17.7	1.26 V	302	34.3	2.0
7	7440.00	51.7 PK	74.0	-22.3	1.58 V	262	44.1	7.6
8	7440.00	43.8 AV	54.0	-10.2	1.58 V	262	36.2	7.6

Remarks:

1. Emission Level(dBuV/m) = Raw Value(dBuV) + Correction Factor(dB/m)
2. Correction Factor(dB/m) = Antenna Factor(dB/m) + Cable Factor(dB) – Pre-Amplifier Factor(dB)
3. Margin value = Emission Level – Limit value
4. The other emission levels were very low against the limit.
5. " * " : Fundamental frequency.

Below 1GHz Data:

BT_GFSK

RF Mode	TX BT_GFSK	Channel	CH 0 : 2402 MHz
Frequency Range	9kHz ~ 1GHz	Detector Function	Quasi-Peak (QP)

Antenna Polarity & Test Distance : Horizontal at 3 m								
No	Frequency (MHz)	Emission Level (dBuV/m)	Limit (dBuV/m)	Margin (dB)	Antenna Height (m)	Table Angle (Degree)	Raw Value (dBuV)	Correction Factor (dB/m)
1	119.81	38.4 QP	43.5	-5.1	3.00 H	338	53.5	-15.1
2	167.44	35.6 QP	43.5	-7.9	2.00 H	162	48.7	-13.1
3	226.07	33.2 QP	46.0	-12.8	2.00 H	115	49.1	-15.9
4	299.38	35.1 QP	46.0	-10.9	1.50 H	89	47.4	-12.3
5	336.56	33.9 QP	46.0	-12.1	1.50 H	342	45.2	-11.3
6	574.97	26.8 QP	46.0	-19.2	1.50 H	123	33.0	-6.2

Remarks:

1. Emission Level(dBuV/m) = Raw Value(dBuV) + Correction Factor(dB/m)
2. Correction Factor(dB/m) = Antenna Factor(dB/m) + Cable Factor(dB) – Pre-Amplifier Factor(dB)
3. Margin value = Emission Level – Limit value
4. The other emission levels were very low against the limit of frequency range 30MHz~1000MHz.
5. The emission levels were very low against the limit of frequency range 9kHz~30MHz: the amplitude of spurious emissions attenuated more than 20 dB below the permissible value to be report.

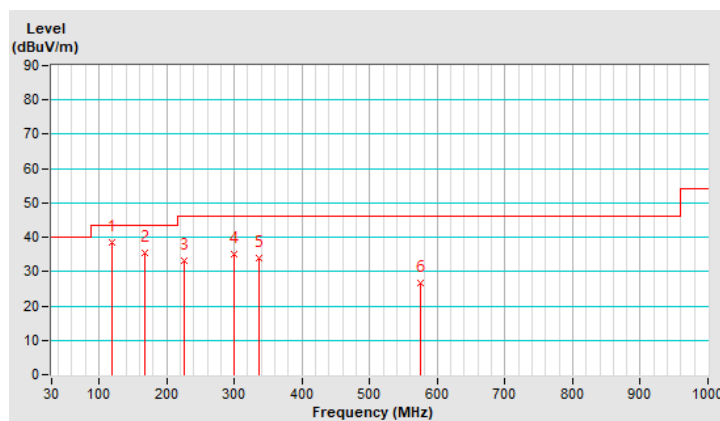

RF Mode	TX BT_GFSK	Channel	CH 0 : 2402 MHz
Frequency Range	9kHz ~ 1GHz	Detector Function	Quasi-Peak (QP)

Antenna Polarity & Test Distance : Vertical at 3 m								
No	Frequency (MHz)	Emission Level (dBuV/m)	Limit (dBuV/m)	Margin (dB)	Antenna Height (m)	Table Angle (Degree)	Raw Value (dBuV)	Correction Factor (dB/m)
1	126.28	29.4 QP	43.5	-14.1	1.00 V	34	43.8	-14.4
2	166.34	31.5 QP	43.5	-12.0	1.50 V	215	44.6	-13.1
3	224.43	31.8 QP	46.0	-14.2	1.00 V	148	47.8	-16.0
4	340.76	26.6 QP	46.0	-19.4	1.50 V	175	37.9	-11.3
5	499.18	24.6 QP	46.0	-21.4	1.50 V	58	32.2	-7.6
6	949.15	32.1 QP	46.0	-13.9	1.00 V	125	32.7	-0.6

Remarks:

1. Emission Level(dBuV/m) = Raw Value(dBuV) + Correction Factor(dB/m)
2. Correction Factor(dB/m) = Antenna Factor(dB/m) + Cable Factor(dB) – Pre-Amplifier Factor(dB)
3. Margin value = Emission Level – Limit value
4. The other emission levels were very low against the limit of frequency range 30MHz~1000MHz.
5. The emission levels were very low against the limit of frequency range 9kHz~30MHz: the amplitude of spurious emissions attenuated more than 20 dB below the permissible value to be report.

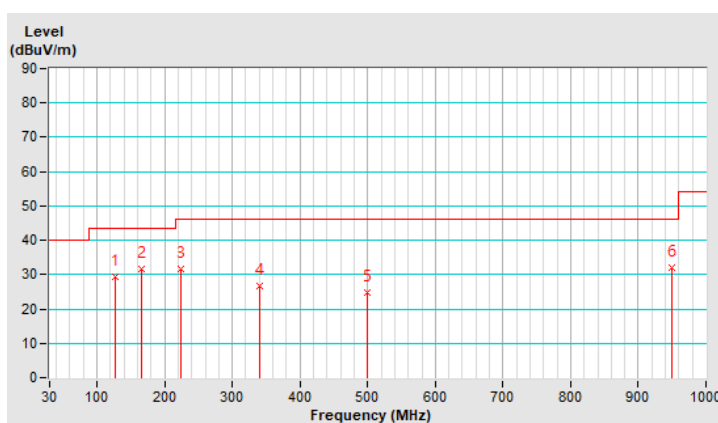



PIFA Antenna

Above 1GHz Data:

BT_GFSK

RF Mode	TX BT_GFSK	Channel	CH 0 : 2402 MHz
Frequency Range	1GHz ~ 25GHz	Detector Function	Peak (PK) Average (AV)

Antenna Polarity & Test Distance : Horizontal at 3 m

No	Frequency (MHz)	Emission Level (dBuV/m)	Limit (dBuV/m)	Margin (dB)	Antenna Height (m)	Table Angle (Degree)	Raw Value (dBuV)	Correction Factor (dB/m)
1	2382.23	55.3 PK	74.0	-18.7	1.00 H	328	57.9	-2.6
2	2382.23	43.3 AV	54.0	-10.7	1.00 H	328	45.9	-2.6
3	*2402.00	105.7 PK			1.00 H	328	108.4	-2.7
4	*2402.00	105.3 AV			1.00 H	328	108.0	-2.7
5	4804.00	42.0 PK	74.0	-32.0	1.40 H	158	40.2	1.8
6	4804.00	33.3 AV	54.0	-20.7	1.40 H	158	31.5	1.8

Antenna Polarity & Test Distance : Vertical at 3 m

No	Frequency (MHz)	Emission Level (dBuV/m)	Limit (dBuV/m)	Margin (dB)	Antenna Height (m)	Table Angle (Degree)	Raw Value (dBuV)	Correction Factor (dB/m)
1	2363.00	56.5 PK	74.0	-17.5	2.15 V	84	59.2	-2.7
2	2363.00	42.9 AV	54.0	-11.1	2.15 V	84	45.6	-2.7
3	*2402.00	104.1 PK			2.15 V	84	106.8	-2.7
4	*2402.00	103.2 AV			2.15 V	84	105.9	-2.7
5	4804.00	40.2 PK	74.0	-33.8	1.08 V	115	38.4	1.8
6	4804.00	30.3 AV	54.0	-23.7	1.08 V	115	28.5	1.8

Remarks:

1. Emission Level(dBuV/m) = Raw Value(dBuV) + Correction Factor(dB/m)
2. Correction Factor(dB/m) = Antenna Factor(dB/m) + Cable Factor(dB) – Pre-Amplifier Factor(dB)
3. Margin value = Emission Level – Limit value
4. The other emission levels were very low against the limit.
5. " * " : Fundamental frequency.

RF Mode	TX BT_GFSK	Channel	CH 39 : 2441 MHz
Frequency Range	1GHz ~ 25GHz	Detector Function	Peak (PK) Average (AV)

Antenna Polarity & Test Distance : Horizontal at 3 m								
No	Frequency (MHz)	Emission Level (dBuV/m)	Limit (dBuV/m)	Margin (dB)	Antenna Height (m)	Table Angle (Degree)	Raw Value (dBuV)	Correction Factor (dB/m)
1	*2441.00	106.7 PK			1.09 H	324	109.4	-2.7
2	*2441.00	106.4 AV			1.09 H	324	109.1	-2.7
3	4882.00	41.9 PK	74.0	-32.1	1.44 H	150	40.2	1.7
4	4882.00	33.1 AV	54.0	-20.9	1.44 H	150	31.4	1.7
5	7323.00	53.4 PK	74.0	-20.6	1.48 H	6	46.1	7.3
6	7323.00	44.5 AV	54.0	-9.5	1.48 H	6	37.2	7.3

Antenna Polarity & Test Distance : Vertical at 3 m								
No	Frequency (MHz)	Emission Level (dBuV/m)	Limit (dBuV/m)	Margin (dB)	Antenna Height (m)	Table Angle (Degree)	Raw Value (dBuV)	Correction Factor (dB/m)
1	*2441.00	105.2 PK			2.09 V	73	107.9	-2.7
2	*2441.00	104.6 AV			2.09 V	73	107.3	-2.7
3	4882.00	40.4 PK	74.0	-33.6	1.08 V	102	38.7	1.7
4	4882.00	30.7 AV	54.0	-23.3	1.08 V	102	29.0	1.7
5	7323.00	48.7 PK	74.0	-25.3	3.87 V	332	41.4	7.3
6	7323.00	40.1 AV	54.0	-13.9	3.87 V	332	32.8	7.3

Remarks:

1. Emission Level(dBuV/m) = Raw Value(dBuV) + Correction Factor(dB/m)
2. Correction Factor(dB/m) = Antenna Factor(dB/m) + Cable Factor(dB) – Pre-Amplifier Factor(dB)
3. Margin value = Emission Level – Limit value
4. The other emission levels were very low against the limit.
5. " * " : Fundamental frequency.

RF Mode	TX BT_GFSK	Channel	CH 78 : 2480 MHz
Frequency Range	1GHz ~ 25GHz	Detector Function	Peak (PK) Average (AV)

Antenna Polarity & Test Distance : Horizontal at 3 m								
No	Frequency (MHz)	Emission Level (dBuV/m)	Limit (dBuV/m)	Margin (dB)	Antenna Height (m)	Table Angle (Degree)	Raw Value (dBuV)	Correction Factor (dB/m)
1	*2480.00	105.9 PK			1.03 H	325	108.7	-2.8
2	*2480.00	105.4 AV			1.03 H	325	108.2	-2.8
3	2488.90	55.7 PK	74.0	-18.3	1.03 H	325	58.5	-2.8
4	2488.90	43.5 AV	54.0	-10.5	1.03 H	325	46.3	-2.8
5	4960.00	42.0 PK	74.0	-32.0	1.41 H	164	40.0	2.0
6	4960.00	33.0 AV	54.0	-21.0	1.41 H	164	31.0	2.0
7	7440.00	53.5 PK	74.0	-20.5	1.51 H	20	45.9	7.6
8	7440.00	44.5 AV	54.0	-9.5	1.51 H	20	36.9	7.6

Antenna Polarity & Test Distance : Vertical at 3 m								
No	Frequency (MHz)	Emission Level (dBuV/m)	Limit (dBuV/m)	Margin (dB)	Antenna Height (m)	Table Angle (Degree)	Raw Value (dBuV)	Correction Factor (dB/m)
1	*2480.00	103.8 PK			2.24 V	86	106.6	-2.8
2	*2480.00	102.9 AV			2.24 V	86	105.7	-2.8
3	2483.50	54.7 PK	74.0	-19.3	2.24 V	86	57.5	-2.8
4	2483.50	43.5 AV	54.0	-10.5	2.24 V	86	46.3	-2.8
5	4960.00	40.2 PK	74.0	-33.8	1.11 V	90	38.2	2.0
6	4960.00	30.2 AV	54.0	-23.8	1.11 V	90	28.2	2.0
7	7440.00	48.8 PK	74.0	-25.2	3.82 V	323	41.2	7.6
8	7440.00	40.1 AV	54.0	-13.9	3.82 V	323	32.5	7.6

Remarks:

1. Emission Level(dBuV/m) = Raw Value(dBuV) + Correction Factor(dB/m)
2. Correction Factor(dB/m) = Antenna Factor(dB/m) + Cable Factor(dB) – Pre-Amplifier Factor(dB)
3. Margin value = Emission Level – Limit value
4. The other emission levels were very low against the limit.
5. " * " : Fundamental frequency.

BT_8DPSK

RF Mode	TX BT_8DPSK	Channel	CH 0 : 2402 MHz
Frequency Range	1GHz ~ 25GHz	Detector Function	Peak (PK) Average (AV)

Antenna Polarity & Test Distance : Horizontal at 3 m

No	Frequency (MHz)	Emission Level (dBuV/m)	Limit (dBuV/m)	Margin (dB)	Antenna Height (m)	Table Angle (Degree)	Raw Value (dBuV)	Correction Factor (dB/m)
1	2340.70	55.8 PK	74.0	-18.2	1.06 H	331	58.4	-2.6
2	2340.70	43.3 AV	54.0	-10.7	1.06 H	331	45.9	-2.6
3	*2402.00	106.5 PK			1.06 H	331	109.2	-2.7
4	*2402.00	103.1 AV			1.06 H	331	105.8	-2.7
5	4804.00	40.5 PK	74.0	-33.5	1.35 H	149	38.7	1.8
6	4804.00	30.7 AV	54.0	-23.3	1.35 H	149	28.9	1.8

Antenna Polarity & Test Distance : Vertical at 3 m

No	Frequency (MHz)	Emission Level (dBuV/m)	Limit (dBuV/m)	Margin (dB)	Antenna Height (m)	Table Angle (Degree)	Raw Value (dBuV)	Correction Factor (dB/m)
1	2380.30	55.7 PK	74.0	-18.3	2.13 V	80	58.3	-2.6
2	2380.30	43.2 AV	54.0	-10.8	2.13 V	80	45.8	-2.6
3	*2402.00	104.8 PK			2.13 V	80	107.5	-2.7
4	*2402.00	101.4 AV			2.13 V	80	104.1	-2.7
5	4804.00	41.1 PK	74.0	-32.9	1.09 V	97	39.3	1.8
6	4804.00	31.1 AV	54.0	-22.9	1.09 V	97	29.3	1.8

Remarks:

1. Emission Level(dBuV/m) = Raw Value(dBuV) + Correction Factor(dB/m)
2. Correction Factor(dB/m) = Antenna Factor(dB/m) + Cable Factor(dB) – Pre-Amplifier Factor(dB)
3. Margin value = Emission Level – Limit value
4. The other emission levels were very low against the limit.
5. " * " : Fundamental frequency.

RF Mode	TX BT_8DPSK	Channel	CH 39 : 2441 MHz
Frequency Range	1GHz ~ 25GHz	Detector Function	Peak (PK) Average (AV)

Antenna Polarity & Test Distance : Horizontal at 3 m								
No	Frequency (MHz)	Emission Level (dBuV/m)	Limit (dBuV/m)	Margin (dB)	Antenna Height (m)	Table Angle (Degree)	Raw Value (dBuV)	Correction Factor (dB/m)
1	*2441.00	106.4 PK			1.07 H	343	109.1	-2.7
2	*2441.00	103.3 AV			1.07 H	343	106.0	-2.7
3	4882.00	41.1 PK	74.0	-32.9	1.38 H	158	39.4	1.7
4	4882.00	31.2 AV	54.0	-22.8	1.38 H	158	29.5	1.7
5	7323.00	52.9 PK	74.0	-21.1	1.46 H	16	45.6	7.3
6	7323.00	43.9 AV	54.0	-10.1	1.46 H	16	36.6	7.3

Antenna Polarity & Test Distance : Vertical at 3 m								
No	Frequency (MHz)	Emission Level (dBuV/m)	Limit (dBuV/m)	Margin (dB)	Antenna Height (m)	Table Angle (Degree)	Raw Value (dBuV)	Correction Factor (dB/m)
1	*2441.00	105.2 PK			2.13 V	96	107.9	-2.7
2	*2441.00	101.5 AV			2.13 V	96	104.2	-2.7
3	4882.00	40.3 PK	74.0	-33.7	1.09 V	94	38.6	1.7
4	4882.00	30.4 AV	54.0	-23.6	1.09 V	94	28.7	1.7
5	7323.00	48.4 PK	74.0	-25.6	3.93 V	323	41.1	7.3
6	7323.00	40.0 AV	54.0	-14.0	3.93 V	323	32.7	7.3

Remarks:

1. Emission Level(dBuV/m) = Raw Value(dBuV) + Correction Factor(dB/m)
2. Correction Factor(dB/m) = Antenna Factor(dB/m) + Cable Factor(dB) – Pre-Amplifier Factor(dB)
3. Margin value = Emission Level – Limit value
4. The other emission levels were very low against the limit.
5. " * " : Fundamental frequency.

RF Mode	TX BT_8DPSK	Channel	CH 78 : 2480 MHz
Frequency Range	1GHz ~ 25GHz	Detector Function	Peak (PK) Average (AV)

Antenna Polarity & Test Distance : Horizontal at 3 m								
No	Frequency (MHz)	Emission Level (dBuV/m)	Limit (dBuV/m)	Margin (dB)	Antenna Height (m)	Table Angle (Degree)	Raw Value (dBuV)	Correction Factor (dB/m)
1	*2480.00	106.9 PK			1.08 H	332	109.7	-2.8
2	*2480.00	103.5 AV			1.08 H	332	106.3	-2.8
3	2485.70	55.8 PK	74.0	-18.2	1.08 H	332	58.6	-2.8
4	2485.70	43.7 AV	54.0	-10.3	1.08 H	332	46.5	-2.8
5	4960.00	41.3 PK	74.0	-32.7	1.50 H	139	39.3	2.0
6	4960.00	32.6 AV	54.0	-21.4	1.50 H	139	30.6	2.0
7	7440.00	53.5 PK	74.0	-20.5	1.45 H	21	45.9	7.6
8	7440.00	44.8 AV	54.0	-9.2	1.45 H	21	37.2	7.6

Antenna Polarity & Test Distance : Vertical at 3 m								
No	Frequency (MHz)	Emission Level (dBuV/m)	Limit (dBuV/m)	Margin (dB)	Antenna Height (m)	Table Angle (Degree)	Raw Value (dBuV)	Correction Factor (dB/m)
1	*2480.00	104.6 PK			2.21 V	87	107.4	-2.8
2	*2480.00	101.1 AV			2.21 V	87	103.9	-2.8
3	2483.50	55.2 PK	74.0	-18.8	2.21 V	87	58.0	-2.8
4	2483.50	43.9 AV	54.0	-10.1	2.21 V	87	46.7	-2.8
5	4960.00	40.0 PK	74.0	-34.0	1.06 V	92	38.0	2.0
6	4960.00	30.5 AV	54.0	-23.5	1.06 V	92	28.5	2.0
7	7440.00	48.4 PK	74.0	-25.6	3.84 V	342	40.8	7.6
8	7440.00	40.0 AV	54.0	-14.0	3.84 V	342	32.4	7.6

Remarks:

1. Emission Level(dBuV/m) = Raw Value(dBuV) + Correction Factor(dB/m)
2. Correction Factor(dB/m) = Antenna Factor(dB/m) + Cable Factor(dB) – Pre-Amplifier Factor(dB)
3. Margin value = Emission Level – Limit value
4. The other emission levels were very low against the limit.
5. " * " : Fundamental frequency.

Below 1GHz Data:

BT_GFSK

RF Mode	TX BT_GFSK	Channel	CH 0 : 2402 MHz
Frequency Range	9kHz ~ 1GHz	Detector Function	Quasi-Peak (QP)

Antenna Polarity & Test Distance : Horizontal at 3 m								
No	Frequency (MHz)	Emission Level (dBuV/m)	Limit (dBuV/m)	Margin (dB)	Antenna Height (m)	Table Angle (Degree)	Raw Value (dBuV)	Correction Factor (dB/m)
1	119.84	38.2 QP	43.5	-5.3	3.00 H	345	53.3	-15.1
2	166.13	34.9 QP	43.5	-8.6	2.00 H	161	48.0	-13.1
3	226.00	32.9 QP	46.0	-13.1	2.00 H	127	48.8	-15.9
4	298.75	34.9 QP	46.0	-11.1	1.50 H	91	47.2	-12.3
5	336.59	33.8 QP	46.0	-12.2	1.50 H	324	45.1	-11.3
6	575.39	27.0 QP	46.0	-19.0	1.50 H	123	33.2	-6.2

Remarks:

1. Emission Level(dBuV/m) = Raw Value(dBuV) + Correction Factor(dB/m)
2. Correction Factor(dB/m) = Antenna Factor(dB/m) + Cable Factor(dB) – Pre-Amplifier Factor(dB)
3. Margin value = Emission Level – Limit value
4. The other emission levels were very low against the limit of frequency range 30MHz~1000MHz.
5. The emission levels were very low against the limit of frequency range 9kHz~30MHz: the amplitude of spurious emissions attenuated more than 20 dB below the permissible value to be report.

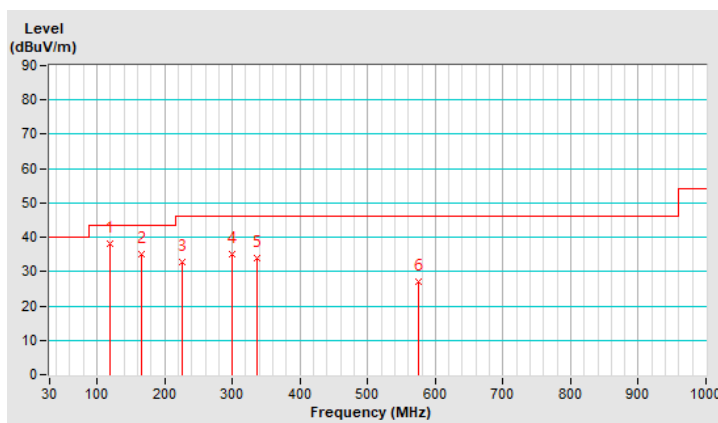

RF Mode	TX BT_GFSK	Channel	CH 0 : 2402 MHz
Frequency Range	9kHz ~ 1GHz	Detector Function	Quasi-Peak (QP)

Antenna Polarity & Test Distance : Vertical at 3 m								
No	Frequency (MHz)	Emission Level (dBuV/m)	Limit (dBuV/m)	Margin (dB)	Antenna Height (m)	Table Angle (Degree)	Raw Value (dBuV)	Correction Factor (dB/m)
1	125.00	28.5 QP	43.5	-15.0	1.00 V	31	43.1	-14.6
2	167.42	32.6 QP	43.5	-10.9	1.50 V	235	45.7	-13.1
3	223.57	31.2 QP	46.0	-14.8	1.00 V	141	47.2	-16.0
4	341.30	26.8 QP	46.0	-19.2	1.50 V	169	38.1	-11.3
5	499.31	24.8 QP	46.0	-21.2	1.50 V	40	32.4	-7.6
6	950.15	33.1 QP	46.0	-12.9	1.00 V	132	33.7	-0.6

Remarks:

1. Emission Level(dBuV/m) = Raw Value(dBuV) + Correction Factor(dB/m)
2. Correction Factor(dB/m) = Antenna Factor(dB/m) + Cable Factor(dB) – Pre-Amplifier Factor(dB)
3. Margin value = Emission Level – Limit value
4. The other emission levels were very low against the limit of frequency range 30MHz~1000MHz.
5. The emission levels were very low against the limit of frequency range 9kHz~30MHz: the amplitude of spurious emissions attenuated more than 20 dB below the permissible value to be report.

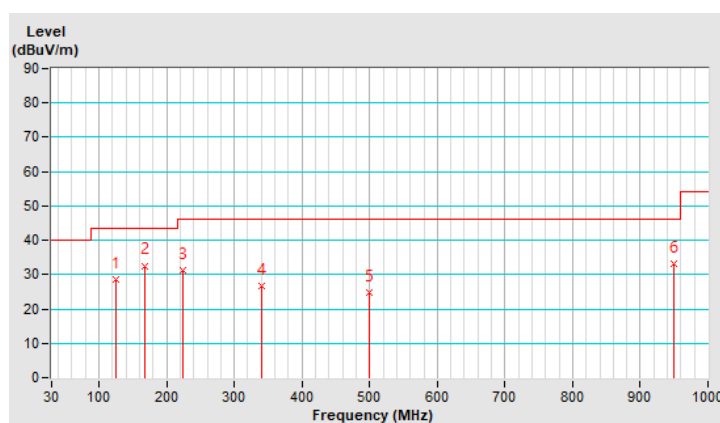

4.2 Conducted Emission Measurement

4.2.1 Limits of Conducted Emission Measurement

Frequency (MHz)	Conducted Limit (dBuV)	
	Quasi-peak	Average
0.15 - 0.5	66 - 56	56 - 46
0.50 - 5.0	56	46
5.0 - 30.0	60	50

Note: 1. The lower limit shall apply at the transition frequencies.

2. The limit decreases in line with the logarithm of the frequency in the range of 0.15 to 0.50MHz.

4.2.2 Test Instruments

DESCRIPTION & MANUFACTURER	MODEL NO.	SERIAL NO.	CALIBRATED DATE	CALIBRATED UNTIL
Test Receiver R&S	ESCS 30	847124/029	Oct. 20, 2020	Oct. 19, 2021
Line-Impedance Stabilization Network (for EUT) R&S	ESH3-Z5	848773/004	Oct. 27, 2020	Oct. 26, 2021
Line-Impedance Stabilization Network (for Peripheral) R&S	ESH3-Z5	835239/001	Mar. 26, 2021	Mar. 25, 2022
50 ohms Terminator	50	3	Oct. 26, 2020	Oct. 25, 2021
RF Cable	5D-FB	COCCAB-001	Sep. 26, 2020	Sep. 25, 2021
Fixed attenuator EMCI	STI02-2200-10	005	Aug. 29, 2020	Aug. 28, 2021
Software BVADT	BVADT_Cond_ V7.3.7.4	NA	NA	NA

1. The calibration interval of the above test instruments are 12 months and the calibrations are traceable to NML/ROC and NIST/USA.
2. The test was performed in Conduction 1.
3. Tested Date: June 21, 2021

4.2.3 Test Procedures

- The EUT was placed 0.4 meters from the conducting wall of the shielded room with EUT being connected to the power mains through a line impedance stabilization network (LISN). Other support units were connected to the power mains through another LISN. The two LISNs provide 50 ohm/ 50uH of coupling impedance for the measuring instrument.
- Both lines of the power mains connected to the EUT were checked for maximum conducted interference.
- The frequency range from 150kHz to 30MHz was searched. Emission levels under (Limit - 20dB) was not recorded.

NOTE: The resolution bandwidth and video bandwidth of test receiver is 9kHz for quasi-peak detection (QP) and average detection (AV) at frequency 0.15MHz-30MHz.

4.2.4 Deviation From Test Standard

No deviation.

4.2.5 Test Setup

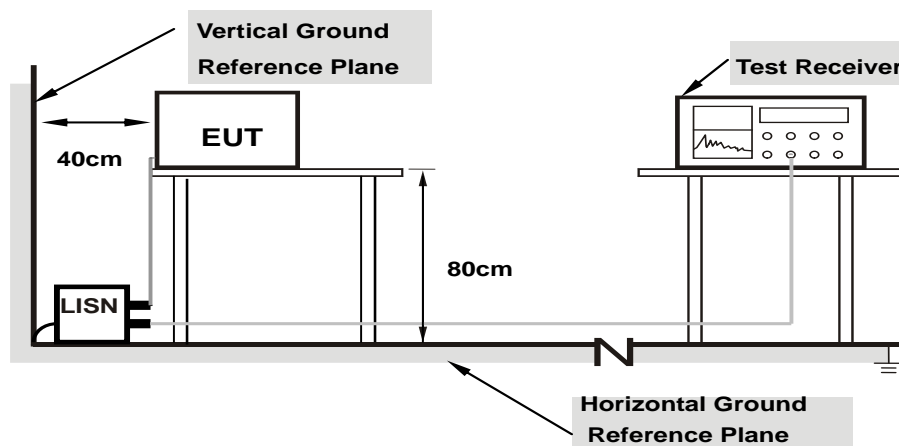

Note: 1.Support units were connected to second LISN.

For the actual test configuration, please refer to the attached file (Test Setup Photo).

4.2.6 EUT Operating Condition

Same as 4.1.6.

4.2.7 Test Results (Mode 1)

RF Mode	TX BT_GFSK	Channel	CH 0 : 2402 MHz
Frequency Range	150kHz ~ 30MHz	Detector Function & Resolution Bandwidth	Quasi-Peak (QP) / Average (AV), 9kHz

Phase Of Power : Line (L)										
No	Frequency (MHz)	Correction Factor (dB)	Reading Value (dBuV)		Emission Level (dBuV)		Limit (dBuV)		Margin (dB)	
			Q.P.	AV.	Q.P.	AV.	Q.P.	AV.	Q.P.	AV.
1	0.15000	9.95	39.04	17.39	48.99	27.34	66.00	56.00	-17.01	-28.66
2	0.16953	9.96	39.70	22.87	49.66	32.83	64.98	54.98	-15.32	-22.15
3	0.21250	9.97	32.49	18.98	42.46	28.95	63.11	53.11	-20.65	-24.16
4	0.25156	9.98	27.20	10.22	37.18	20.20	61.71	51.71	-24.53	-31.51
5	0.40781	9.99	16.61	7.44	26.60	17.43	57.69	47.69	-31.09	-30.26
6	25.87109	11.24	24.30	24.15	35.54	35.39	60.00	50.00	-24.46	-14.61

Remarks:

1. Q.P. and AV. are abbreviations of quasi-peak and average individually.
2. The emission levels of other frequencies were very low against the limit.
3. Margin value = Emission level – Limit value
4. Correction factor = Insertion loss + Cable loss
5. Emission Level = Correction Factor + Reading Value

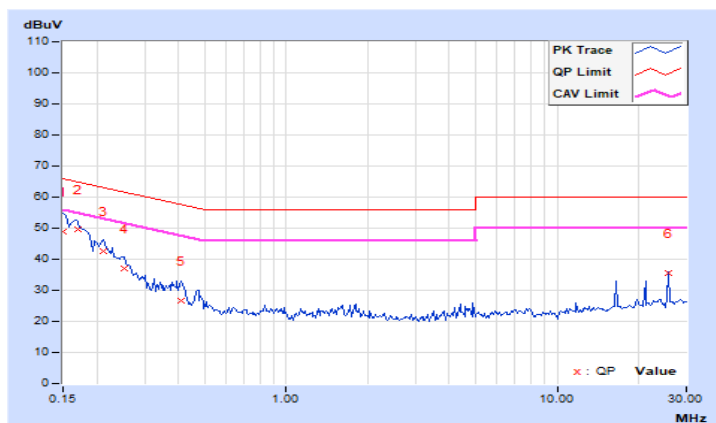

RF Mode	TX BT_GFSK	Channel	CH 0 : 2402 MHz
Frequency Range	150kHz ~ 30MHz	Detector Function & Resolution Bandwidth	Quasi-Peak (QP) / Average (AV), 9kHz

Phase Of Power : Neutral (N)										
No	Frequency (MHz)	Correction Factor (dB)	Reading Value (dBuV)		Emission Level (dBuV)		Limit (dBuV)		Margin (dB)	
			Q.P.	AV.	Q.P.	AV.	Q.P.	AV.	Q.P.	AV.
1	0.15000	9.92	41.24	21.78	51.16	31.70	66.00	56.00	-14.84	-24.30
2	0.16172	9.93	37.47	17.22	47.40	27.15	65.38	55.38	-17.98	-28.23
3	0.18906	9.94	39.72	21.81	49.66	31.75	64.08	54.08	-14.42	-22.33
4	0.23594	9.95	30.69	15.08	40.64	25.03	62.24	52.24	-21.60	-27.21
5	0.38828	9.96	20.23	6.12	30.19	16.08	58.10	48.10	-27.91	-32.02
6	25.87500	10.91	24.82	24.61	35.73	35.52	60.00	50.00	-24.27	-14.48

Remarks:

1. Q.P. and AV. are abbreviations of quasi-peak and average individually.
2. The emission levels of other frequencies were very low against the limit.
3. Margin value = Emission level – Limit value
4. Correction factor = Insertion loss + Cable loss
5. Emission Level = Correction Factor + Reading Value

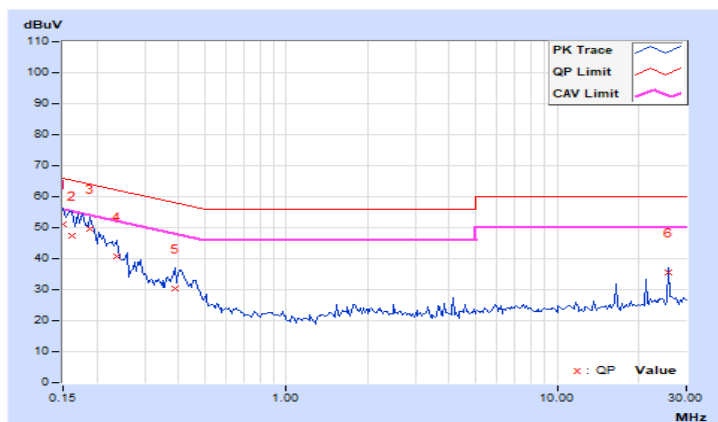

4.2.8 Test Results (Mode 2)

RF Mode	TX BT_GFSK	Channel	CH 0 : 2402 MHz
Frequency Range	150kHz ~ 30MHz	Detector Function & Resolution Bandwidth	Quasi-Peak (QP) / Average (AV), 9kHz

Phase Of Power : Line (L)										
No	Frequency (MHz)	Correction Factor (dB)	Reading Value (dBuV)		Emission Level (dBuV)		Limit (dBuV)		Margin (dB)	
			Q.P.	AV.	Q.P.	AV.	Q.P.	AV.	Q.P.	AV.
1	0.15781	9.95	39.01	17.30	48.96	27.25	65.58	55.58	-16.62	-28.33
2	0.16562	9.96	38.98	21.42	48.94	31.38	65.18	55.18	-16.24	-23.80
3	0.20469	9.97	31.56	15.61	41.53	25.58	63.42	53.42	-21.89	-27.84
4	0.25938	9.98	24.44	12.39	34.42	22.37	61.45	51.45	-27.03	-29.08
5	0.38438	9.99	17.55	8.30	27.54	18.29	58.18	48.18	-30.64	-29.89
6	25.87109	11.24	24.21	24.00	35.45	35.24	60.00	50.00	-24.55	-14.76

Remarks:

1. Q.P. and AV. are abbreviations of quasi-peak and average individually.
2. The emission levels of other frequencies were very low against the limit.
3. Margin value = Emission level – Limit value
4. Correction factor = Insertion loss + Cable loss
5. Emission Level = Correction Factor + Reading Value

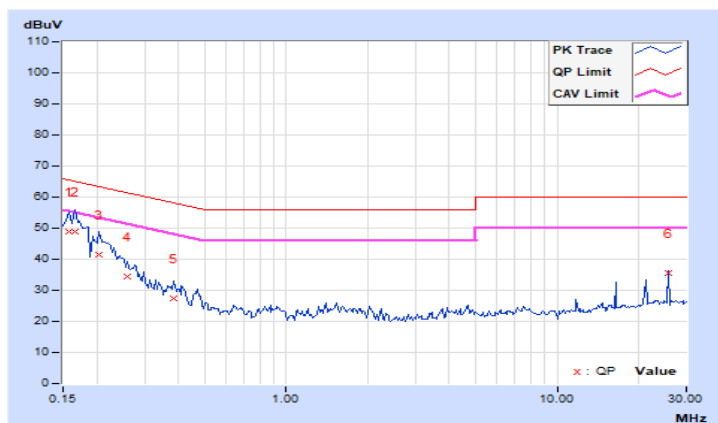

RF Mode	TX BT_GFSK	Channel	CH 0 : 2402 MHz
Frequency Range	150kHz ~ 30MHz	Detector Function & Resolution Bandwidth	Quasi-Peak (QP) / Average (AV), 9kHz

Phase Of Power : Neutral (N)										
No	Frequency (MHz)	Correction Factor (dB)	Reading Value (dBuV)		Emission Level (dBuV)		Limit (dBuV)		Margin (dB)	
			Q.P.	AV.	Q.P.	AV.	Q.P.	AV.	Q.P.	AV.
1	0.15391	9.92	39.87	18.72	49.79	28.64	65.79	55.79	-16.00	-27.15
2	0.16562	9.93	39.01	21.97	48.94	31.90	65.18	55.18	-16.24	-23.28
3	0.21250	9.95	32.75	18.04	42.70	27.99	63.11	53.11	-20.41	-25.12
4	0.41953	9.96	20.50	11.64	30.46	21.60	57.46	47.46	-27.00	-25.86
5	2.03125	10.04	7.29	2.34	17.33	12.38	56.00	46.00	-38.67	-33.62
6	25.87109	10.91	24.70	24.53	35.61	35.44	60.00	50.00	-24.39	-14.56

Remarks:

1. Q.P. and AV. are abbreviations of quasi-peak and average individually.
2. The emission levels of other frequencies were very low against the limit.
3. Margin value = Emission level – Limit value
4. Correction factor = Insertion loss + Cable loss
5. Emission Level = Correction Factor + Reading Value

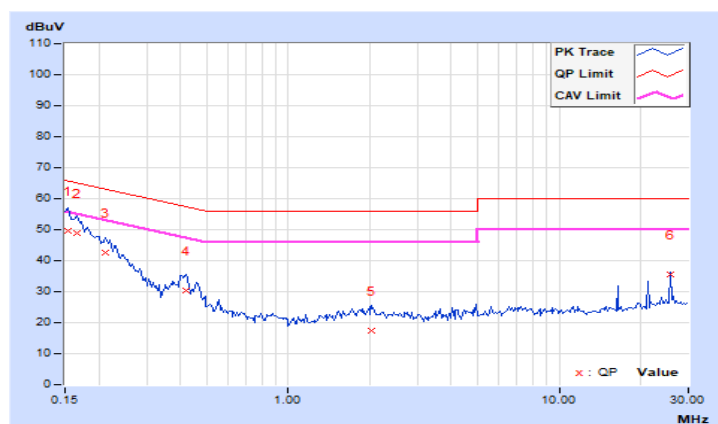

4.3 Number of Hopping Frequency Used

4.3.1 Limits of Hopping Frequency Used Measurement

At least 15 channels frequencies, and should be equally spaced.

4.3.2 Test Setup



4.3.3 Test Instruments

Refer to section 4.1.2 to get information of above instrument.

4.3.4 Test Procedure

- a. Check the calibration of the measuring instrument (SA) using either an internal calibrator or a known signal from an external generator.
- b. Turn on the EUT and connect its antenna terminal to measurement via a low loss cable. Then set it to any one measured frequency within its operating range and make sure the instrument is operated in its linear range.
- c. Set the SA on MaxHold Mode, and then keep the EUT in hopping mode. Record all the signals from each channel until each one has been recorded.
- d. Set the SA on View mode and then plot the result on SA screen.
- e. Repeat above procedures until all frequencies measured were complete.

4.3.5 Deviation from Test Standard

No deviation.

4.3.6 Test Results (Mode 1)

There are 79 hopping frequencies in the hopping mode. Please refer to next page for the test result. On the plots, it shows that the hopping frequencies are equally spaced.

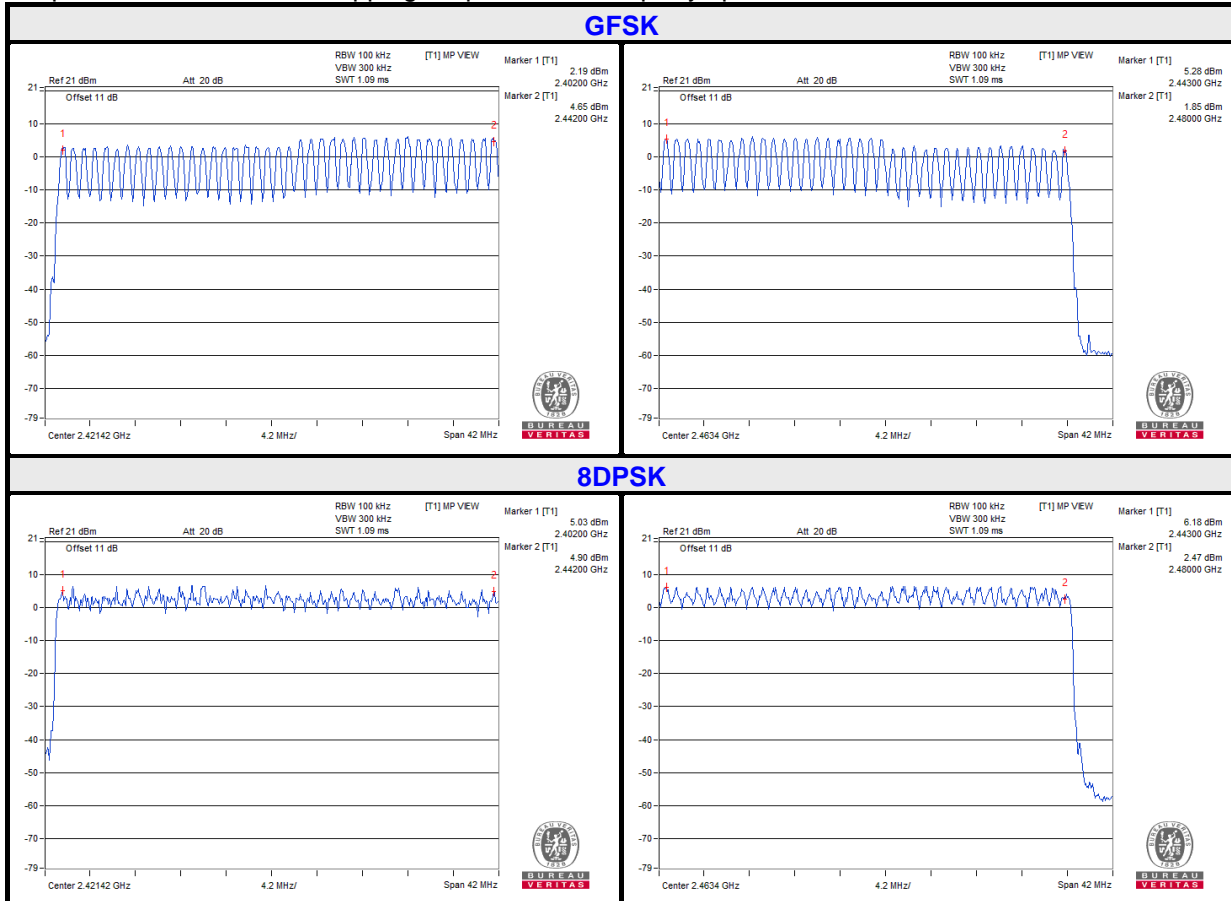

4.3.7 Test Results (Mode 2)

There are 79 hopping frequencies in the hopping mode. Please refer to next page for the test result. On the plots, it shows that the hopping frequencies are equally spaced.

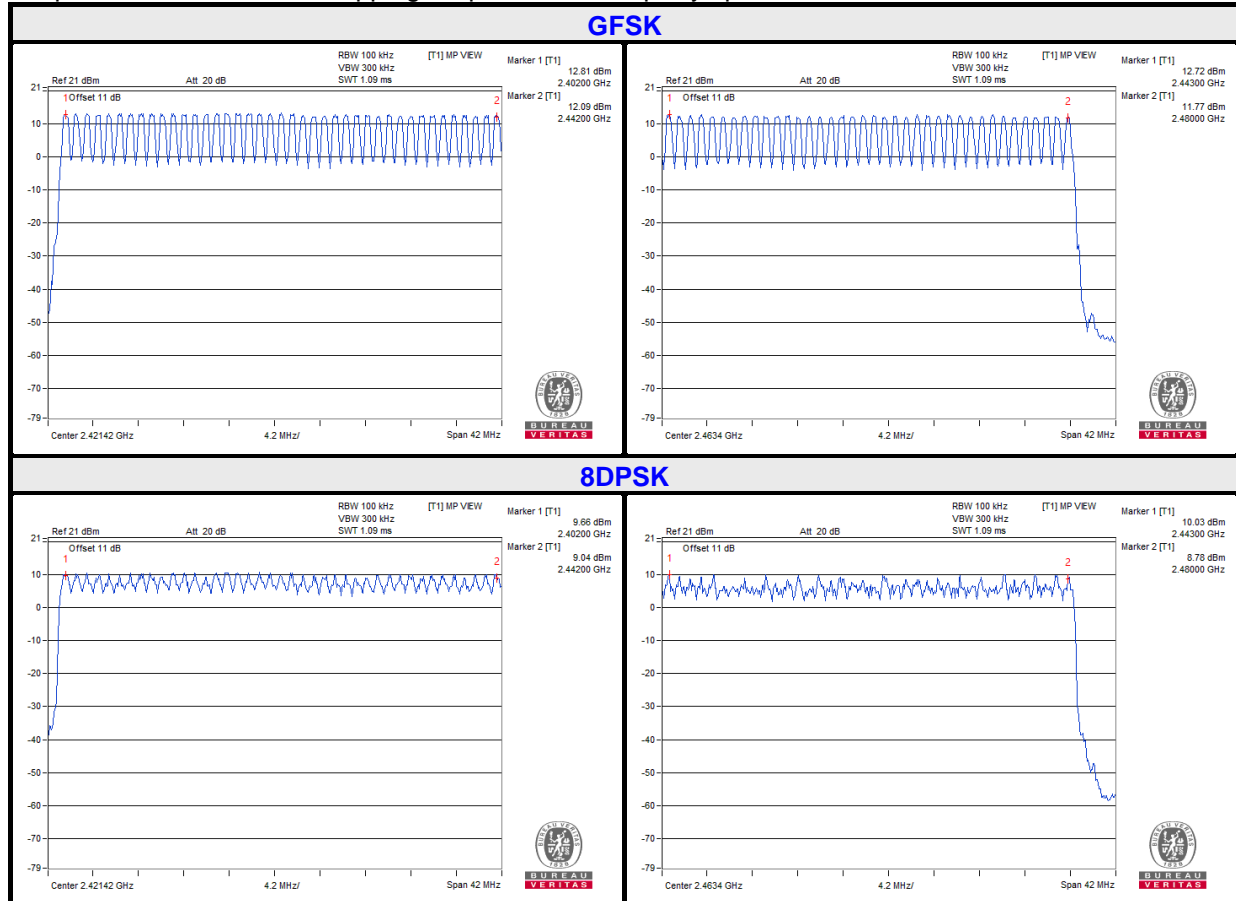

4.4 Dwell Time on Each Channel

4.4.1 Limits of Dwell Time on Each Channel Measurement

The average time of occupancy on any channel shall not be greater than 0.4 seconds within a period of 0.4 seconds multiplied by the number of hopping channels employed.

4.4.2 Test Setup

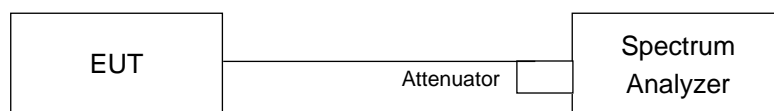

4.4.3 Test Instruments

Refer to section 4.1.2 to get information of above instrument.

4.4.4 Test Procedures

- a. Check the calibration of the measuring instrument (SA) using either an internal calibrator or a known signal from an external generator.
- b. Turn on the EUT and connect its antenna terminal to measurement via a low loss cable. Then set it to any one measured frequency within its operating range and make sure the instrument is operated in its linear range.
- c. Adjust the center frequency of SA on any frequency be measured and set SA to zero span mode. And then, set RBW and VBW of spectrum analyzer to proper value.
- d. Measure the time duration of one transmission on the measured frequency. And then plot the result with time difference of this time duration.
- e. Repeat above procedures until all different time-slot modes have been completed.

4.4.5 Deviation from Test Standard

No deviation.

4.4.6 Test Results (Mode 1)

GFSK

Mode	Number of transmission in a 31.6 (79Hopping*0.4)	Length of transmission time (msec)	Result (msec)	Limit (msec)	Pass/Fail
DH1	50 (times / 5 sec) * 6.32 = 316 times	0.414	130.82	400	Pass
DH3	26 (times / 5 sec) * 6.32 = 165 times	1.72	283.8	400	Pass
DH5	17 (times / 5 sec) * 6.32 = 108 times	3.024	326.59	400	Pass

NOTE: Test plots of the transmitting time slot are shown on next page.



BUREAU
VERITAS

DH1

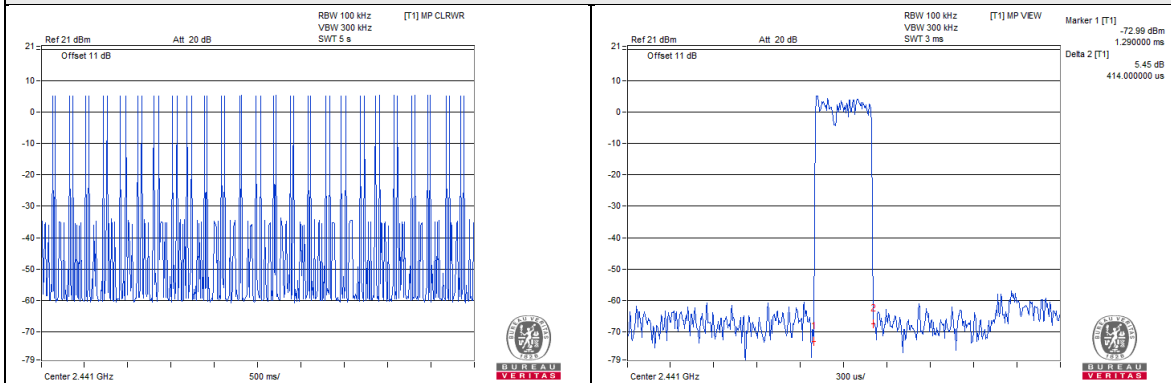

DH3

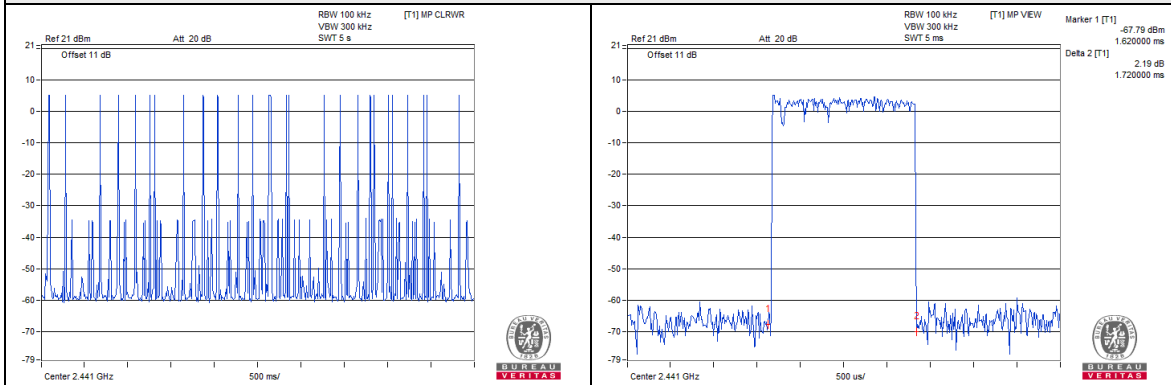

DH5

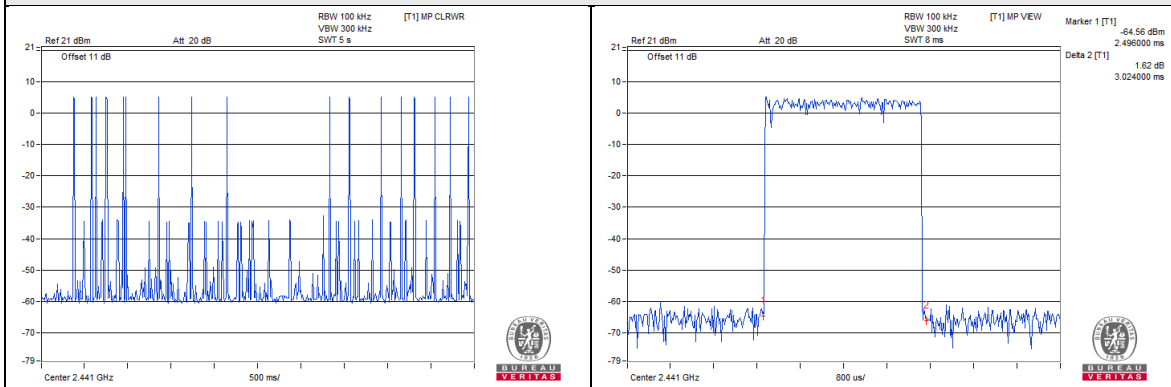



8DPSK

Mode	Number of transmission in a 31.6 (79Hopping*0.4)	Length of transmission time (msec)	Result (msec)	Limit (msec)	Pass/Fail
3DH1	50 (times / 5 sec) * 6.32 = 316 times	0.45	142.2	400	Pass
3DH3	25 (times / 5 sec) * 6.32 = 158 times	1.69	267.02	400	Pass
3DH5	16 (times / 5 sec) * 6.32 = 102 times	3.026	308.65	400	Pass

NOTE: Test plots of the transmitting time slot are shown on next page.



BUREAU
VERITAS

3DH1

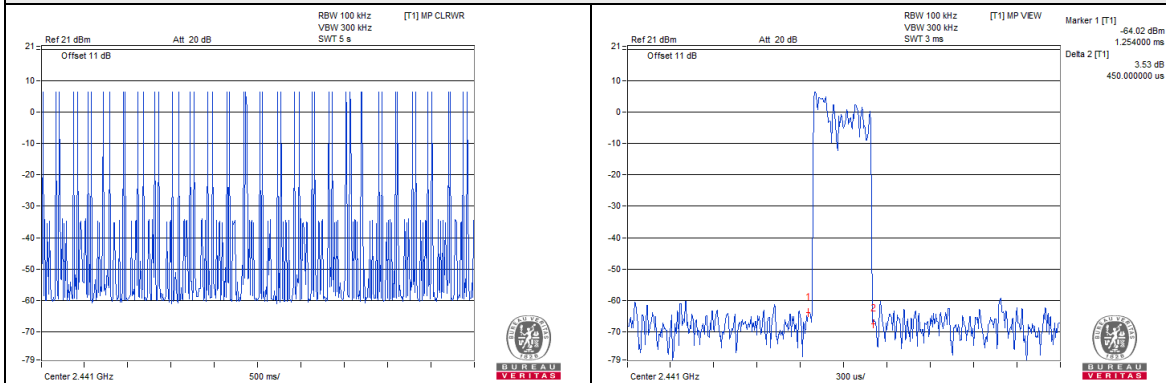

3DH3

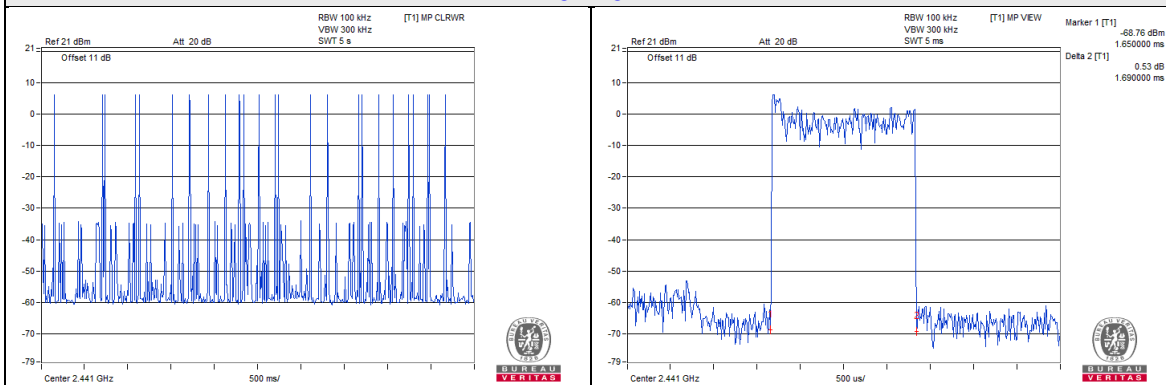

3DH5

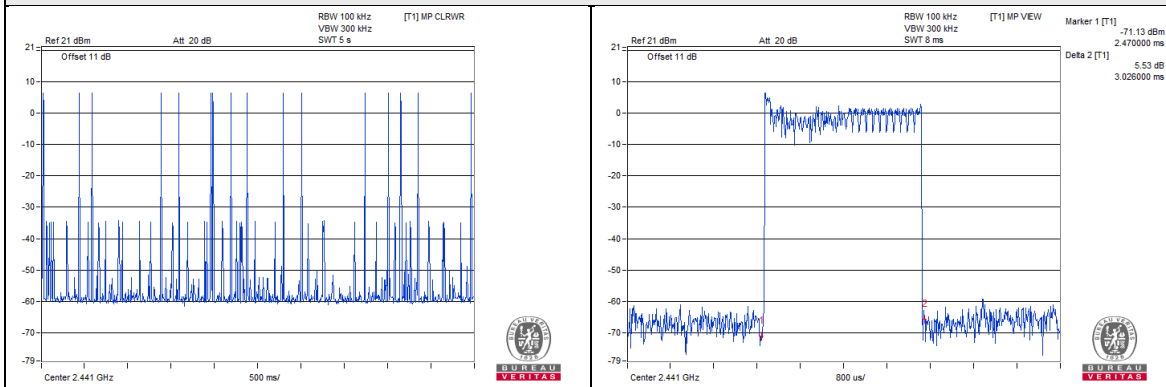



4.4.7 Test Results (Mode 2)

GFSK

Mode	Number of transmission in a 31.6 (79Hopping*0.4)	Length of transmission time (msec)	Result (msec)	Limit (msec)	Pass/Fail
DH1	50 (times / 5 sec) * 6.32 = 316 times	0.438	138.41	400	Pass
DH3	25 (times / 5 sec) * 6.32 = 158 times	1.73	273.34	400	Pass
DH5	16 (times / 5 sec) * 6.32 = 102 times	3.008	306.82	400	Pass

NOTE: Test plots of the transmitting time slot are shown on next page.



BUREAU
VERITAS

DH1

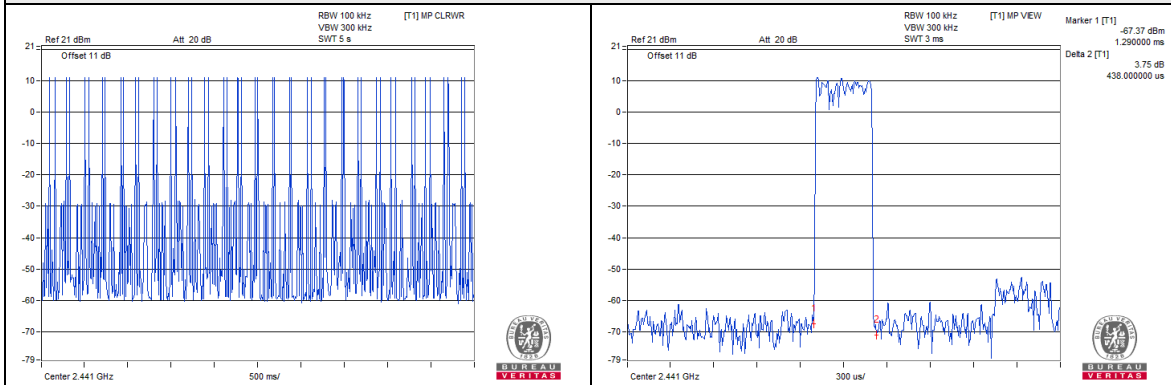

DH3

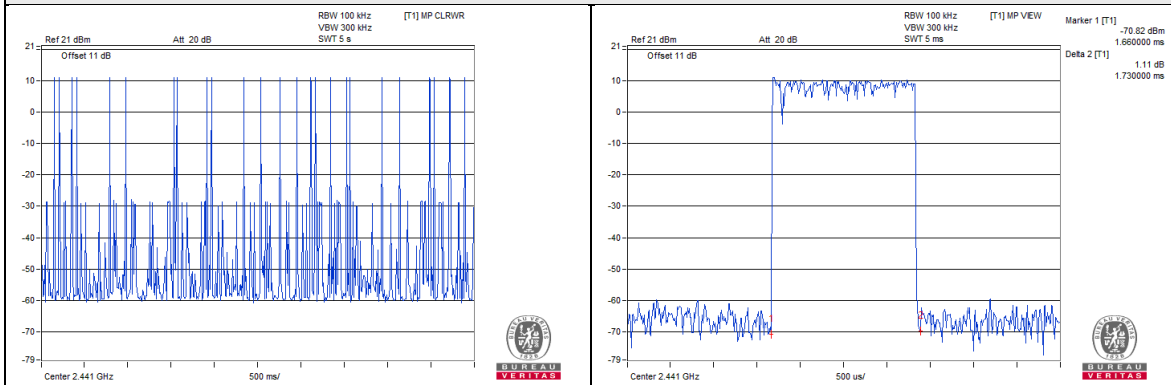

DH5

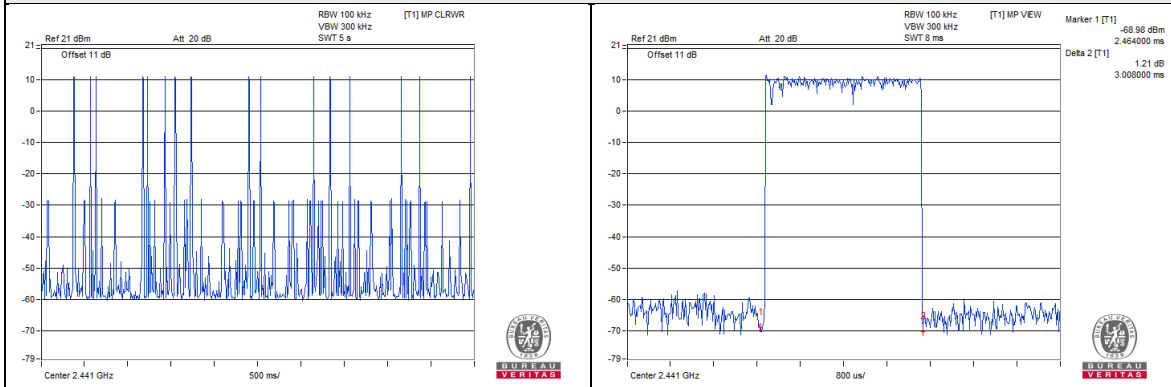

8DPSK

Mode	Number of transmission in a 31.6 (79Hopping*0.4)	Length of transmission time (msec)	Result (msec)	Limit (msec)	Pass/Fail
3DH1	50 (times / 5 sec) * 6.32 = 316 times	0.456	144.1	400	Pass
3DH3	26 (times / 5 sec) * 6.32 = 165 times	1.73	285.45	400	Pass
3DH5	16 (times / 5 sec) * 6.32 = 102 times	2.992	305.18	400	Pass

NOTE: Test plots of the transmitting time slot are shown on next page.

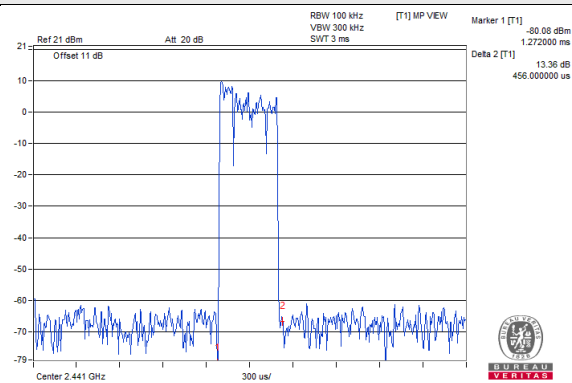
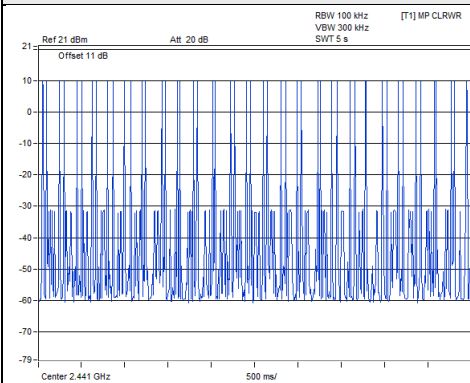
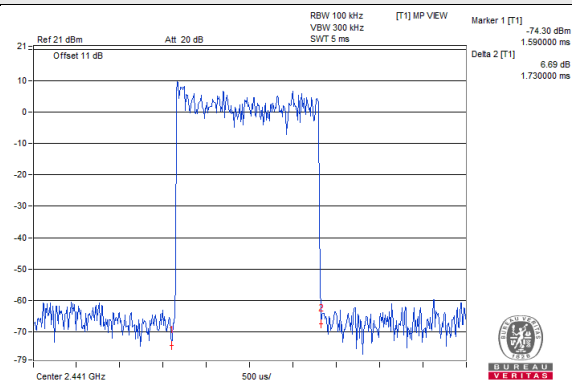
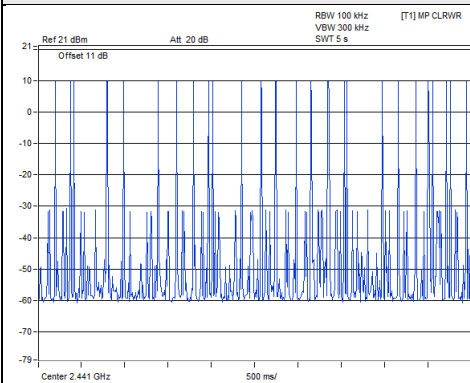
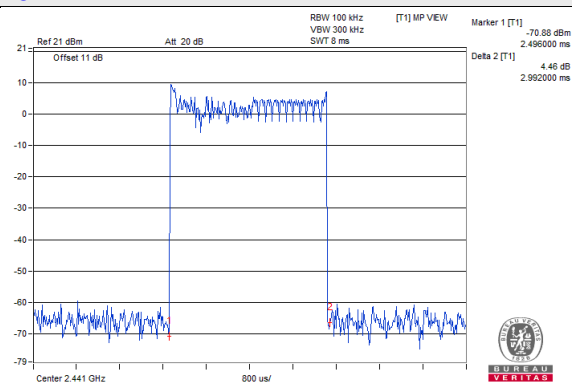
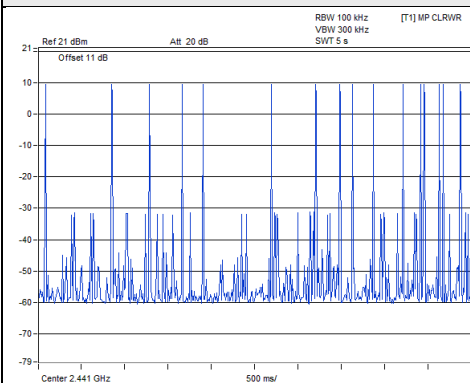
3DH1**3DH3****3DH5**

4.5 Channel Bandwidth

4.5.1 Limits of Channel Bandwidth Measurement

For frequency hopping system operating in the 2400-2483.5MHz, If the 20dB bandwidth of hopping channel is greater than 25kHz, two-thirds 20dB bandwidth of hopping channel shall be a minimum limit for the hopping channel separation.

4.5.2 Test Setup

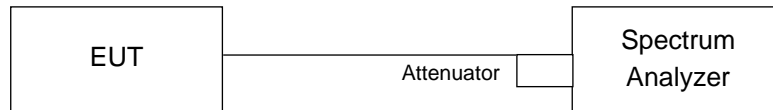

4.5.3 Test Instruments

Refer to section 4.1.2 to get information of above instrument.

4.5.4 Test Procedure

- Check the calibration of the measuring instrument using either an internal calibrator or a known signal from an external generator.
- Turn on the EUT and connect it to measurement instrument. Then set it to any one convenient frequency within its operating range. Set a reference level on the measuring instrument equal to the highest peak value.
- Measure the frequency difference of two frequencies that were attenuated 20dB from the reference level. Record the frequency difference as the emission bandwidth.
- Repeat above procedures until all frequencies measured were complete.

4.5.5 Deviation from Test Standard

No deviation.

4.5.6 EUT Operating Condition

The software provided by client enabled the EUT to transmit and receive data at lowest, middle and highest channel frequencies individually.

4.5.7 Test Results (Mode 1)

Channel	Frequency (MHz)	20dB Bandwidth (MHz)	
		GFSK	8DPSK
0	2402	0.95	1.29
39	2441	0.96	1.29
78	2480	0.96	1.29

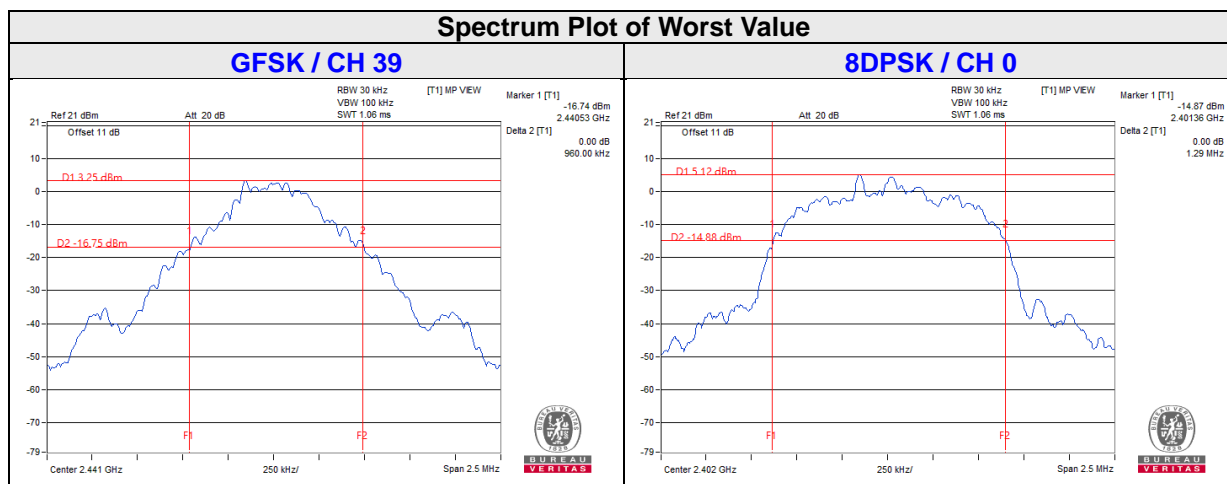

4.5.8 Test Results (Mode 2)

Channel	Frequency (MHz)	20dB Bandwidth (MHz)	
		GFSK	8DPSK
0	2402	0.96	1.29
39	2441	0.96	1.28
78	2480	0.96	1.29

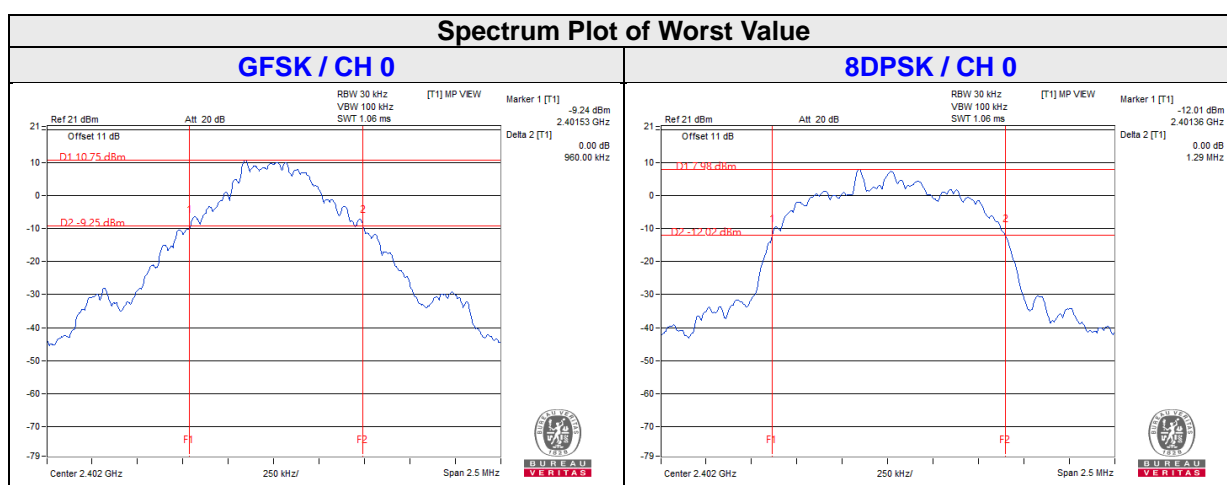

4.6 Hopping Channel Separation

4.6.1 Limits of Hopping Channel Separation Measurement

At least 25kHz or two-third of 20dB hopping channel bandwidth (whichever is greater).

4.6.2 Test Setup

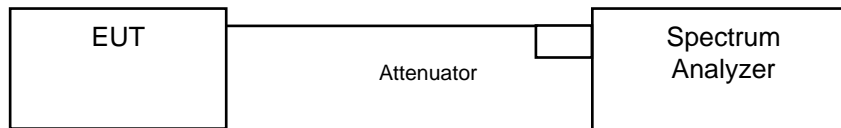

4.6.3 Test Instruments

Refer to section 4.1.2 to get information of above instrument.

4.6.4 Test Procedure

Measurement Procedure REF

- a. Check the calibration of the measuring instrument using either an internal calibrator or a known signal from an external generator.
- b. Turn on the EUT and connect it to measurement instrument. Then set it to any one convenient frequency within its operating range.
- c. By using the MaxHold function record the separation of two adjacent channels.
- d. Measure the frequency difference of these two adjacent channels by SA MARK function. And then plot the result on SA screen.
- e. Repeat above procedures until all frequencies measured were complete.

4.6.5 Deviation from Test Standard

No deviation.

4.6.6 Test Results (Mode 1)

Channel	Frequency (MHz)	Adjacent Channel Separation (MHz)		20dB Bandwidth (MHz)		Minimum Limit (MHz)		Pass / Fail
		GFSK	8DPSK	GFSK	8DPSK	GFSK	8DPSK	
0	2402	1	1	0.95	1.29	0.64	0.86	Pass
39	2441	1	1	0.96	1.29	0.64	0.86	Pass
78	2480	1	1	0.96	1.29	0.64	0.86	Pass

NOTE: The minimum limit is two-third 20dB bandwidth.

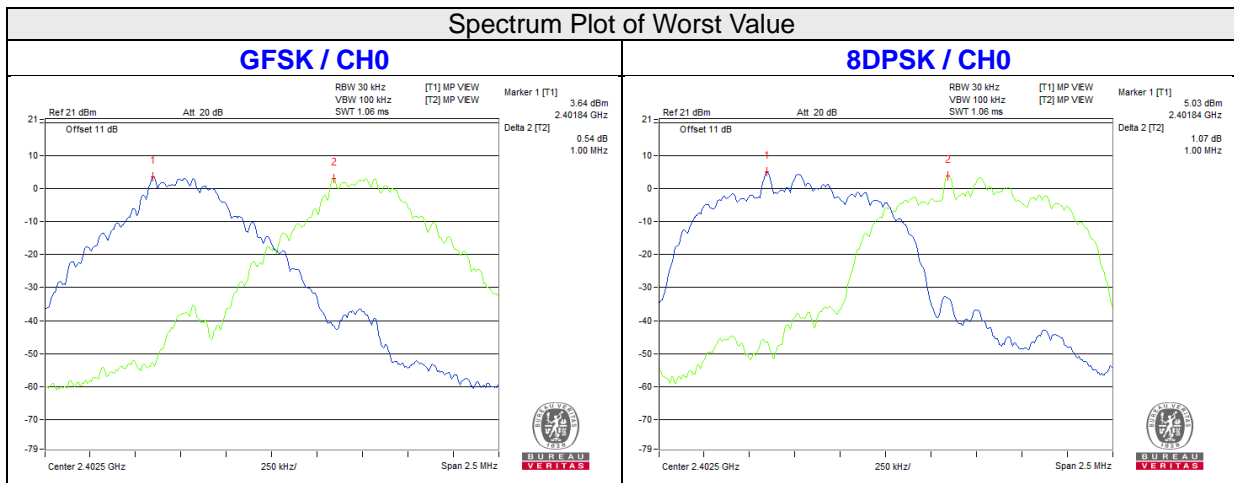

4.6.7 Test Results (Mode 2)

Channel	Frequency (MHz)	Adjacent Channel Separation (MHz)		20dB Bandwidth (MHz)		Minimum Limit (MHz)		Pass / Fail
		GFSK	8DPSK	GFSK	8DPSK	GFSK	8DPSK	
0	2402	1	1	0.96	1.29	0.64	0.86	Pass
39	2441	1	1	0.96	1.28	0.64	0.86	Pass
78	2480	1	1	0.96	1.29	0.64	0.86	Pass

NOTE: The minimum limit is two-third 20dB bandwidth.

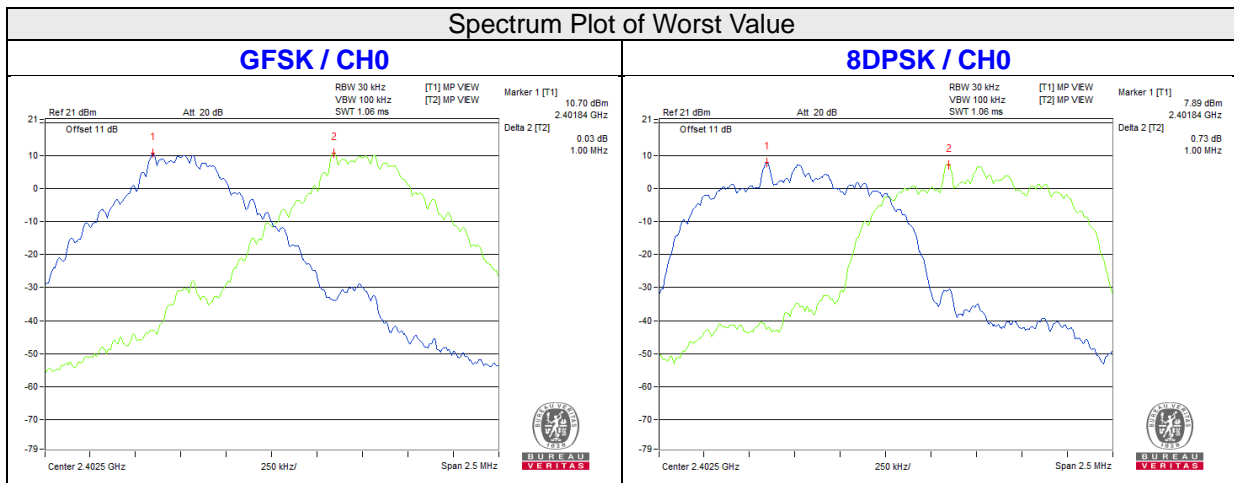

4.7 Maximum Output Power

4.7.1 Limits of Maximum Output Power Measurement

The Maximum Output Power Measurement is 125mW.

4.7.2 Test Setup

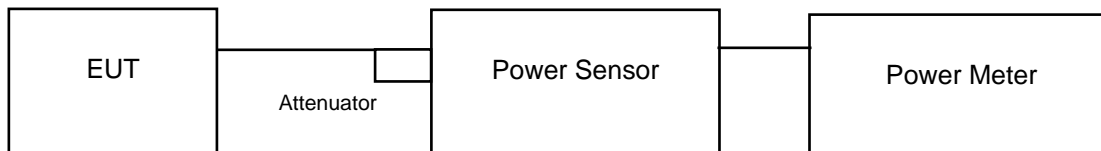

4.7.3 Test Instruments

Refer to section 4.1.2 to get information of above instrument.

4.7.4 Test Procedure

A peak power sensor was used on the output port of the EUT. A power meter was used to read the response of the peak power sensor. Record the power level.

Average power sensor was used to perform output power measurement, trigger and gating function of wide band power meter is enabled to measure max output power of TX on burst. Duty factor is not added to measured value.

4.7.5 Deviation from Test Standard

No deviation.

4.7.6 EUT Operating Condition

The software provided by client enabled the EUT to transmit and receive data at lowest, middle and highest channel frequencies individually.

4.7.7 Test Results (Mode 1)

FOR PEAK POWER

Channel	Frequency (MHZ)	GFSK		8DPSK		Power Limit (mW)	Pass / Fail
		Output Power (mW)	Output Power (dBm)	Output Power (mW)	Output Power (dBm)		
0	2402	4.819	6.83	8.71	9.40	125	Pass
39	2441	4.529	6.56	8.913	9.50	125	Pass
78	2480	4.92	6.92	8.57	9.33	125	Pass

FOR AVERAGE POWER

Channel	Frequency (MHZ)	GFSK		8DPSK	
		Average Power (mW)	Average Power (dBm)	Average Power (mW)	Average Power (dBm)
0	2402	4.355	6.39	4.365	6.40
39	2441	3.908	5.92	4.375	6.41
78	2480	4.395	6.43	4.325	6.36

4.7.8 Test Results (Mode 2)

FOR PEAK POWER

Channel	Frequency (MHZ)	GFSK		8DPSK		Power Limit (mW)	Pass / Fail
		Output Power (mW)	Output Power (dBm)	Output Power (mW)	Output Power (dBm)		
0	2402	17.579	12.45	17.418	12.41	125	Pass
39	2441	17.458	12.42	17.783	12.50	125	Pass
78	2480	17.258	12.37	17.298	12.38	125	Pass

FOR AVERAGE POWER

Channel	Frequency (MHZ)	GFSK		8DPSK	
		Average Power (mW)	Average Power (dBm)	Average Power (mW)	Average Power (dBm)
0	2402	17.022	12.31	8.954	9.52
39	2441	16.904	12.28	8.995	9.54
78	2480	16.749	12.24	8.892	9.49

4.8 Conducted Out of Band Emission Measurement

4.8.1 Limits of Conducted Out of Band Emission Measurement

Below 20dB of the highest emission level of operating band (in 100kHz Resolution Bandwidth).

4.8.2 Test Instruments

Refer to section 4.1.2 to get information of above instrument.

4.8.3 Test Procedure

The transmitter output was connected to the spectrum analyzer via a low lose cable. Set both RBW and VBW of spectrum analyzer to 100 kHz and 300 kHz with suitable frequency span including 100 MHz bandwidth from band edge. The band edges was measured and recorded.

4.8.4 Deviation from Test Standard

No deviation.

4.8.5 EUT Operating Condition

The software provided by client enabled the EUT to transmit and receive data at lowest and highest channel frequencies individually.

4.8.6 Test Results

The spectrum plots are attached on the following images. D1 line indicates the highest level, D2 line indicates the 20dB offset below D1. It shows compliance with the requirement.

4.8.7 Test Results (Mode 1)

GFSK

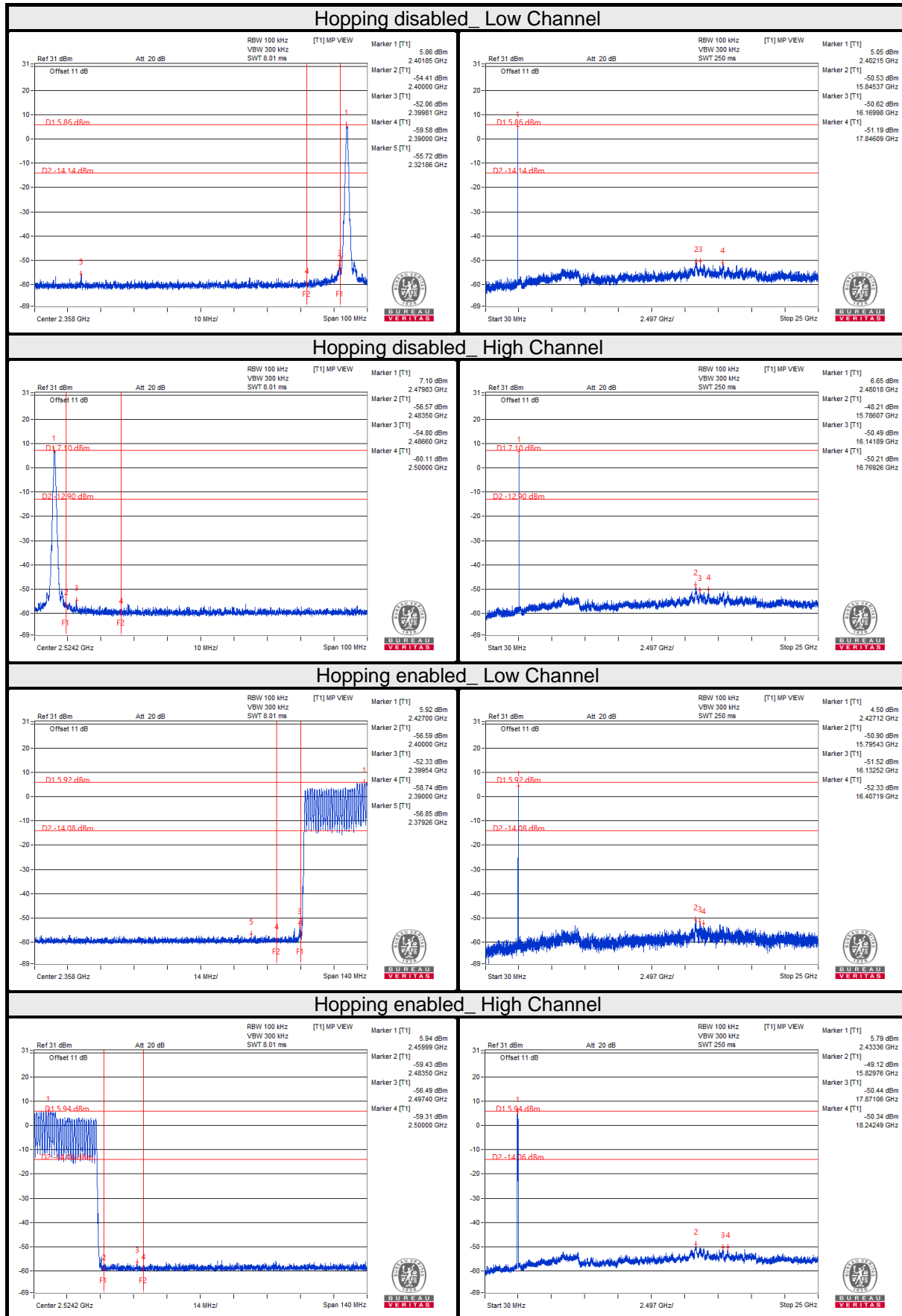

8DPSK

Hopping disabled_Low Channel

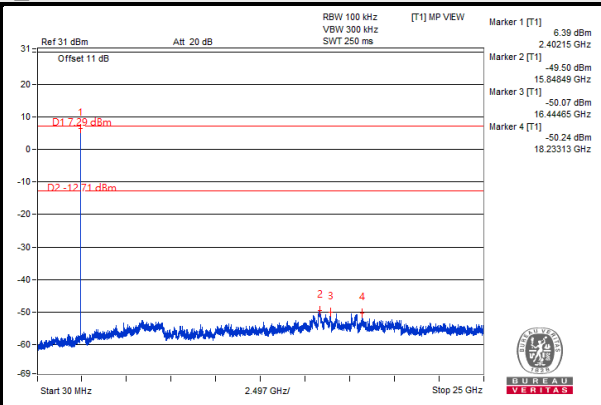
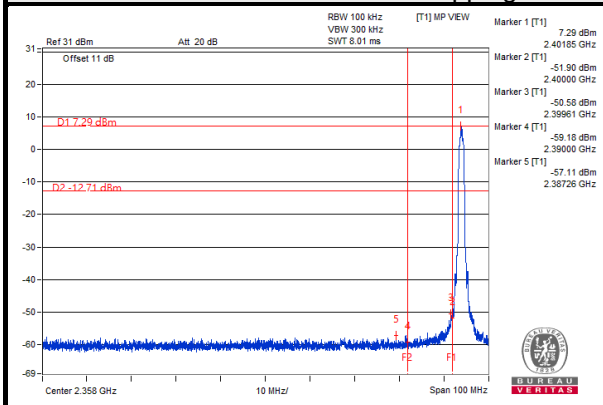

Hopping disabled_High Channel

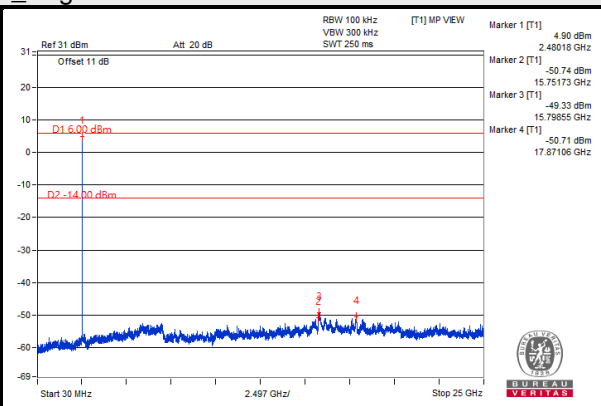
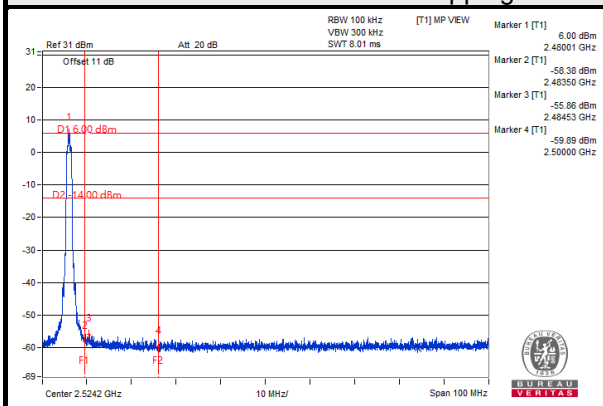

Hopping enabled_Low Channel

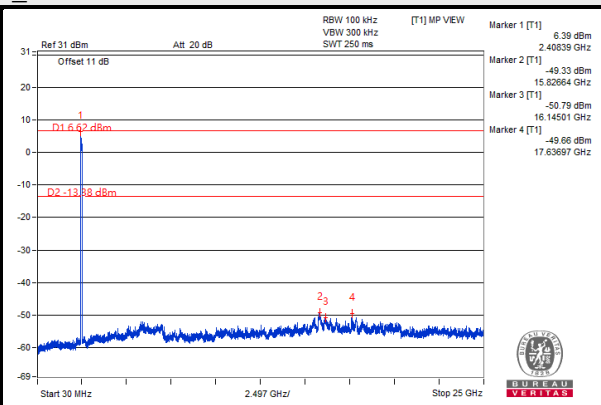
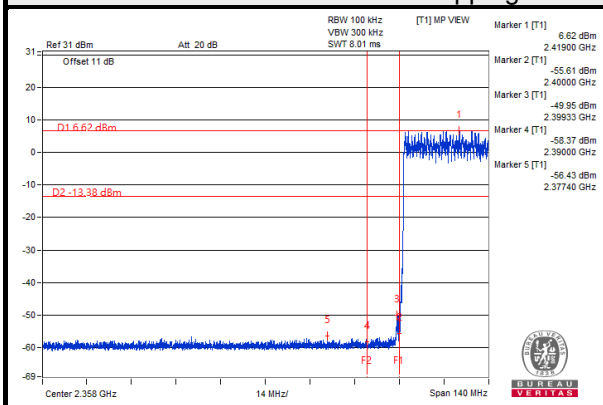

Hopping enabled_High Channel

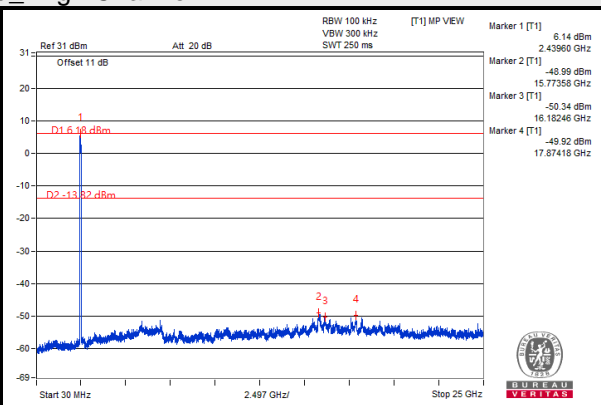
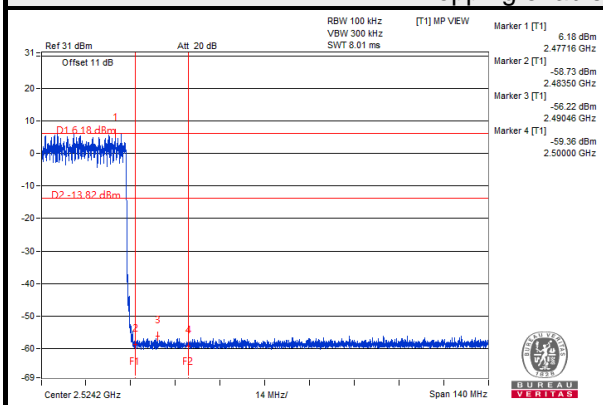

4.8.8 Test Results (Mode 2)

GFSK

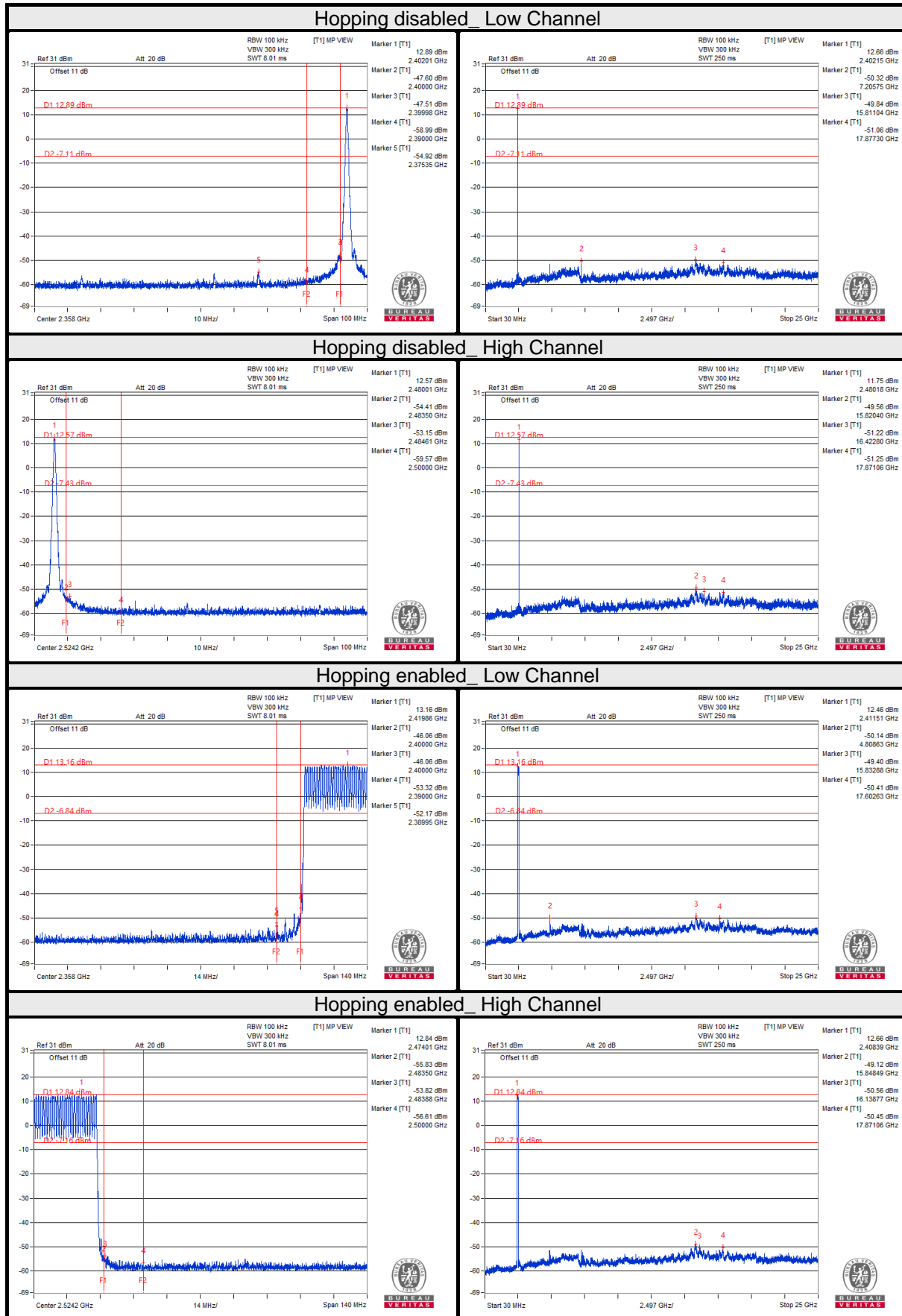

8DPSK

Hopping disabled_Low Channel

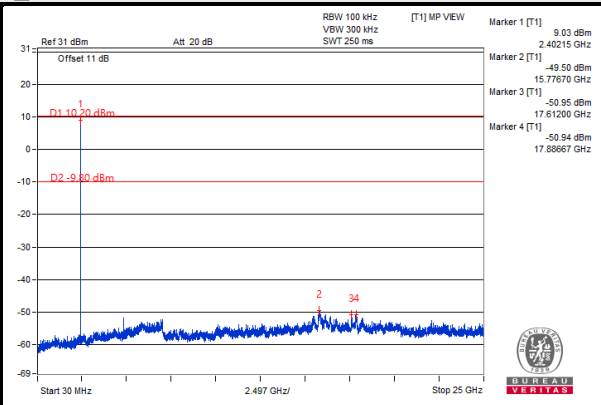
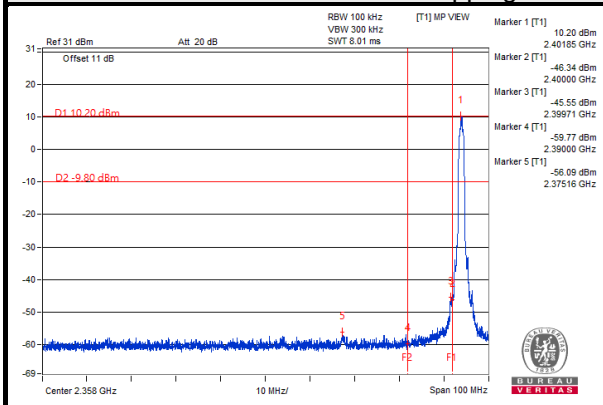

Hopping disabled_High Channel

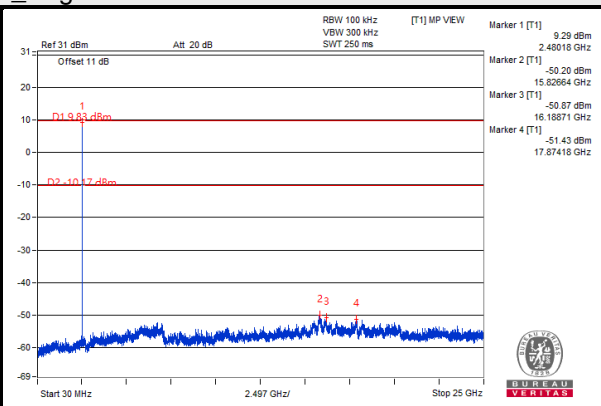
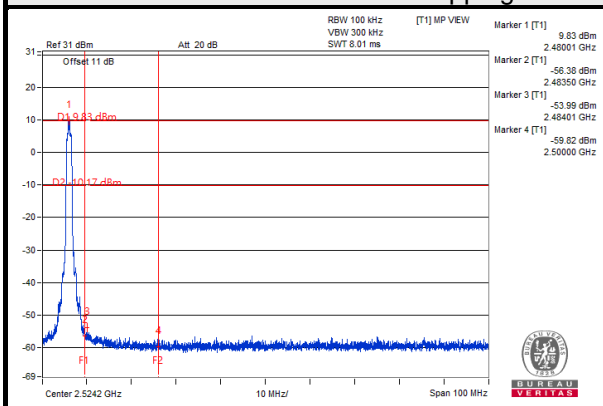

Hopping enabled_Low Channel

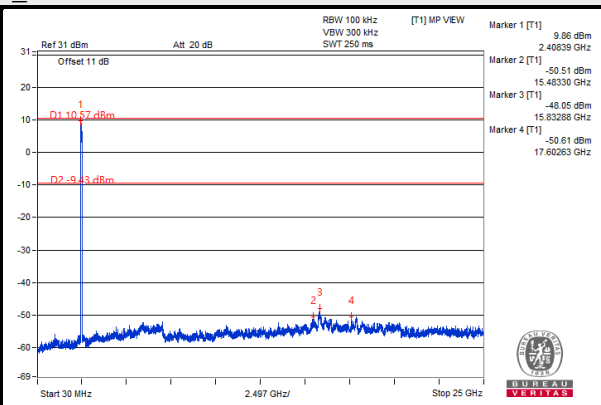
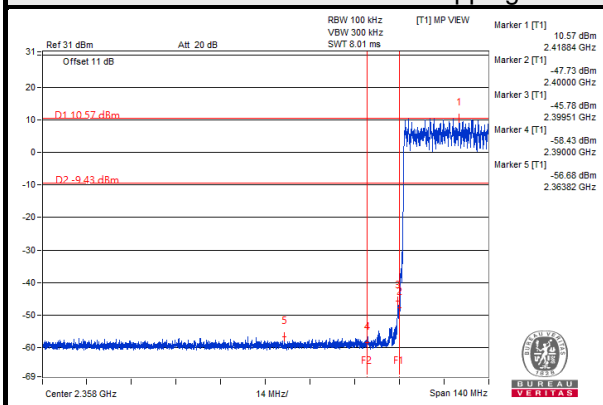

Hopping enabled_High Channel

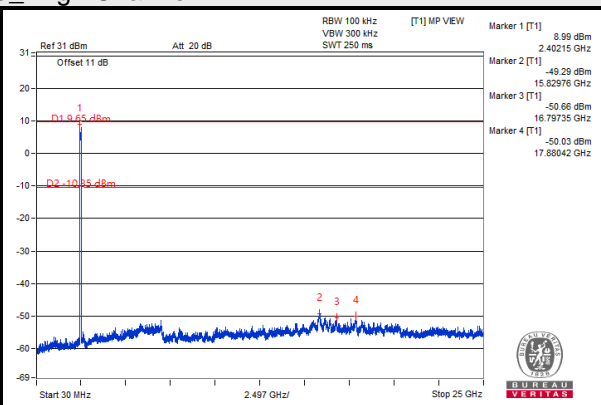
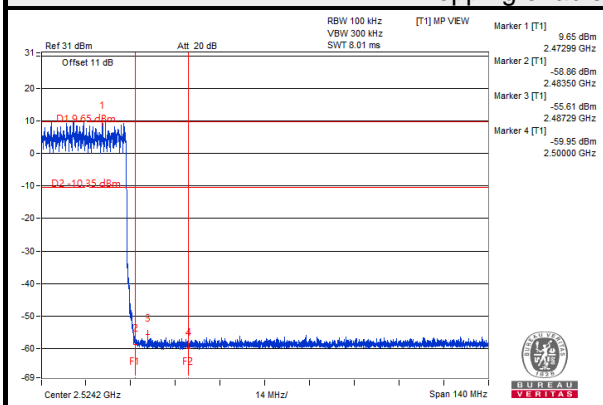

5 Pictures of Test Arrangements

Please refer to the attached file (Test Setup Photo).

Annex A - Band-Edge Measurement

Annex A.1 - Test Results (Mode 1)

Dipole Antenna
BT_GFSK

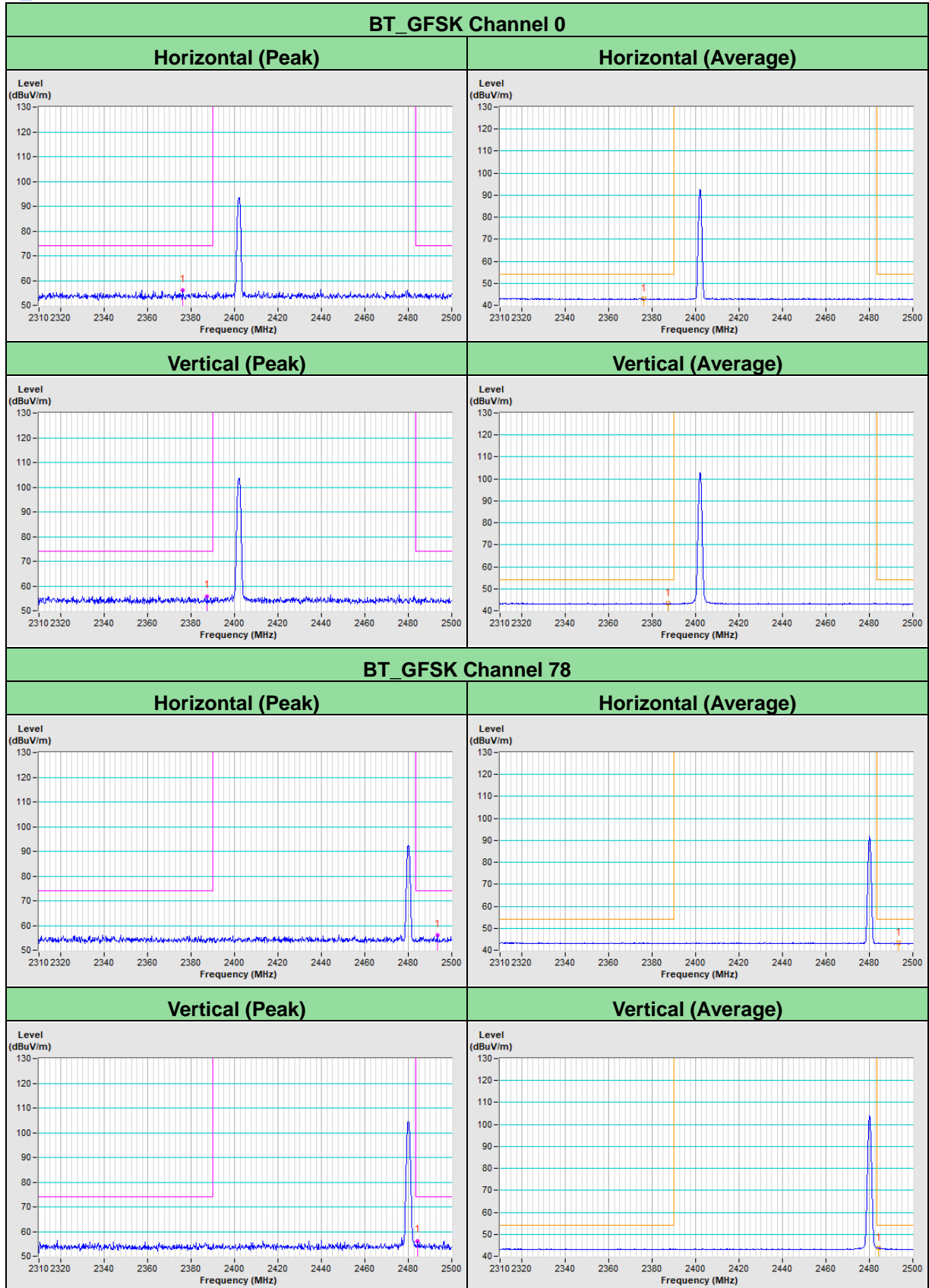

BT_8DPSK

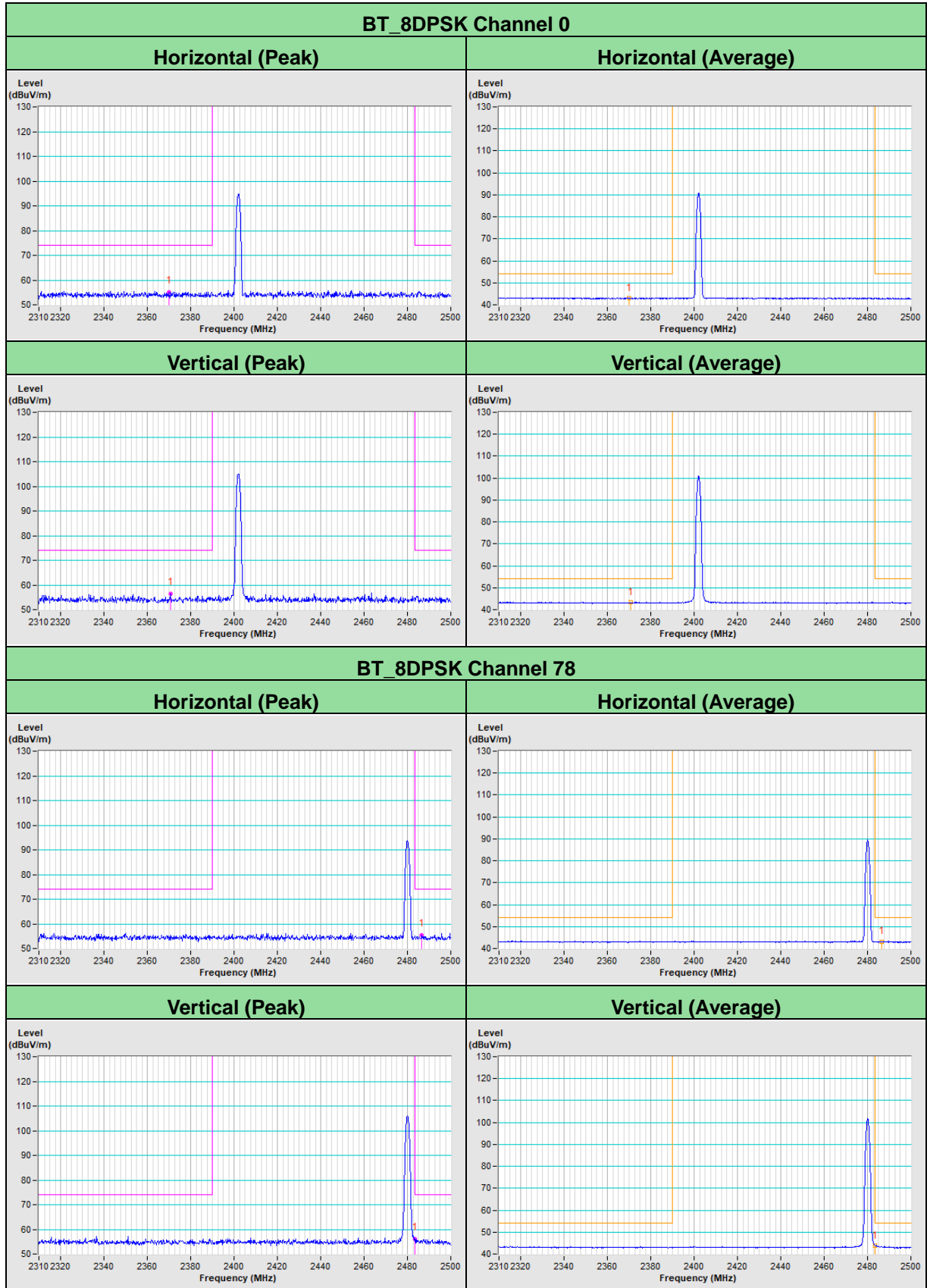

PIFA Antenna

BT_GFSK

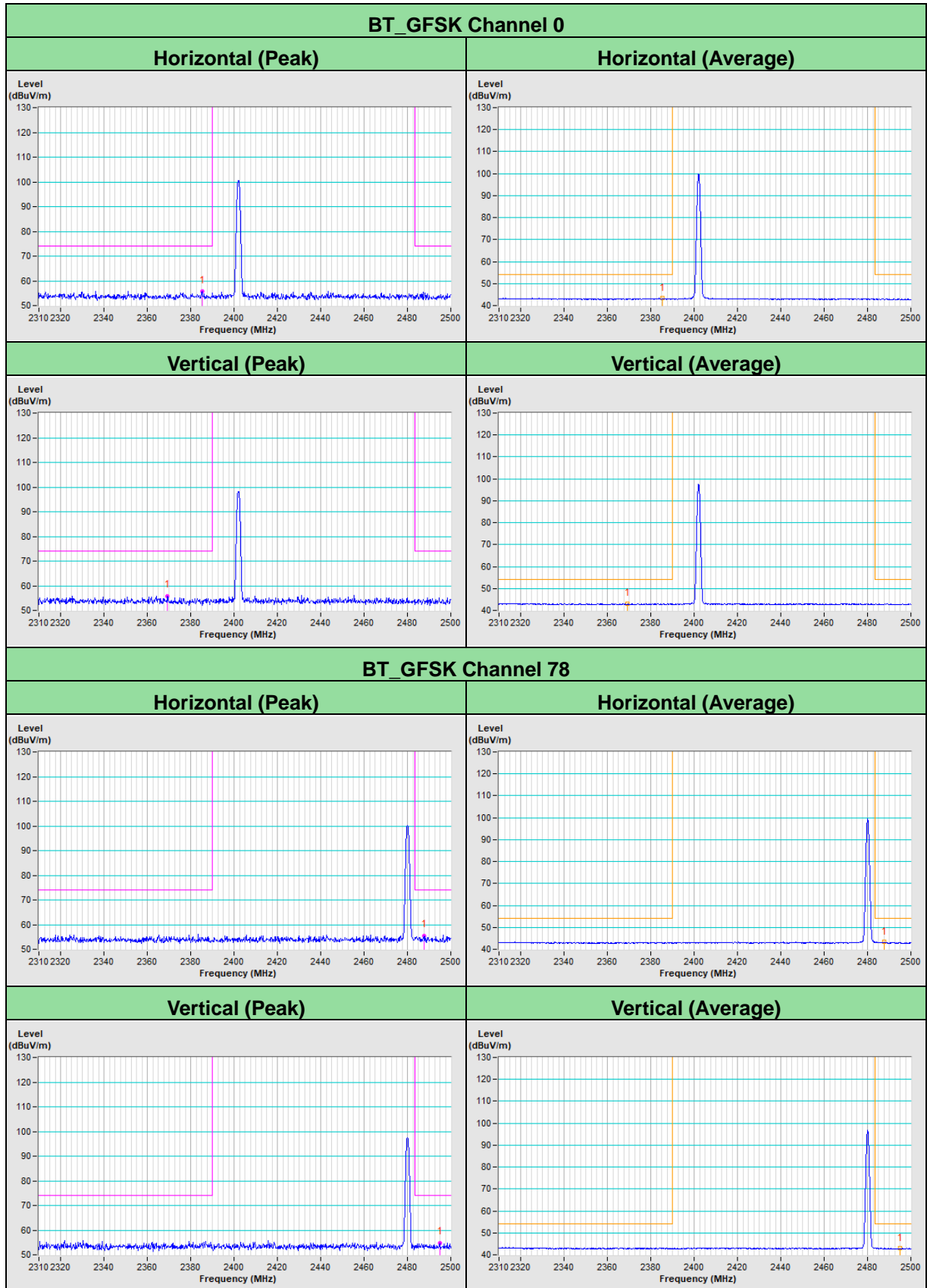

BT_8DPSK

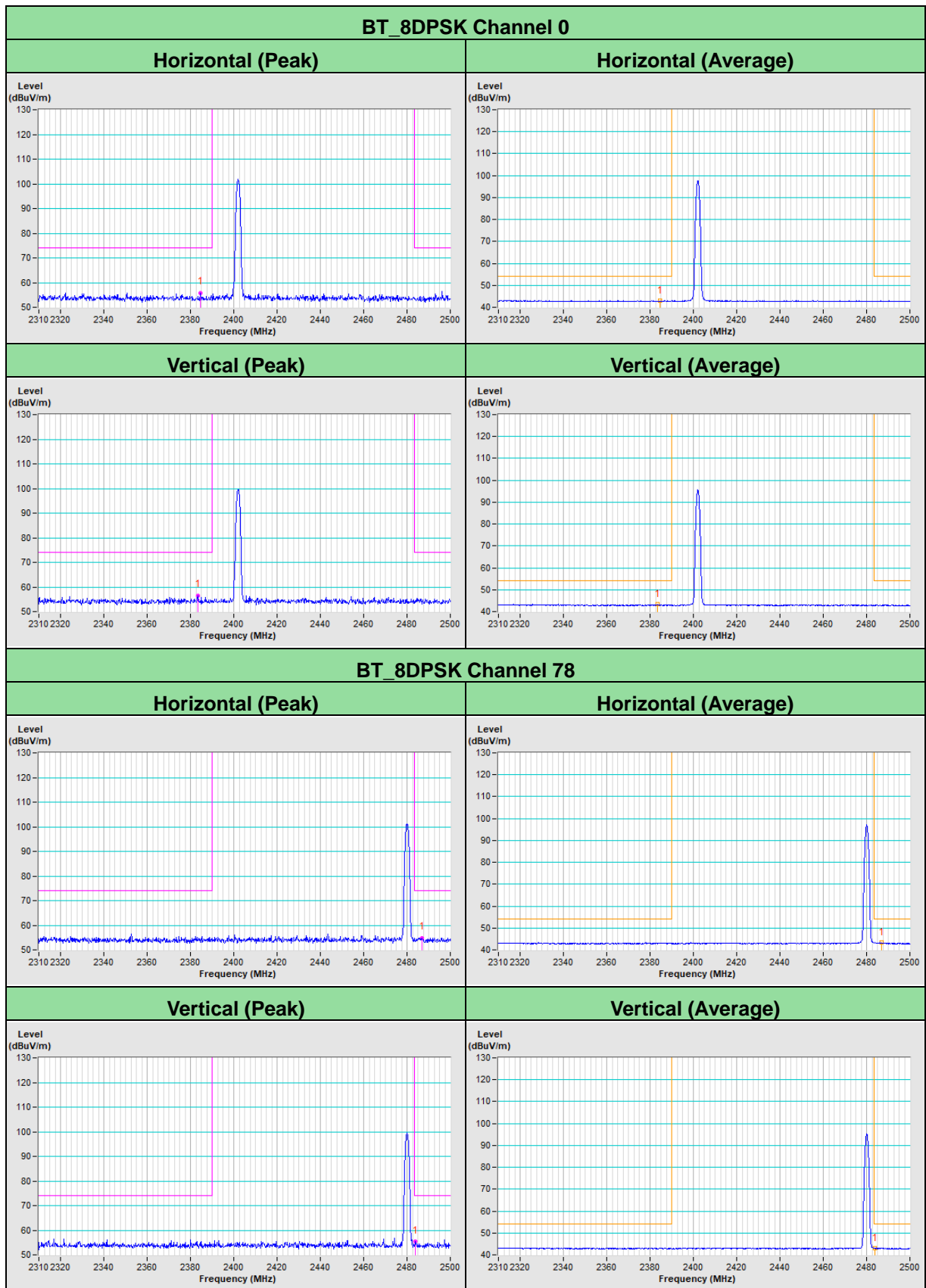

Annex A.2 - Test Results (Mode 2)

Dipole Antenna

BT_GFSK

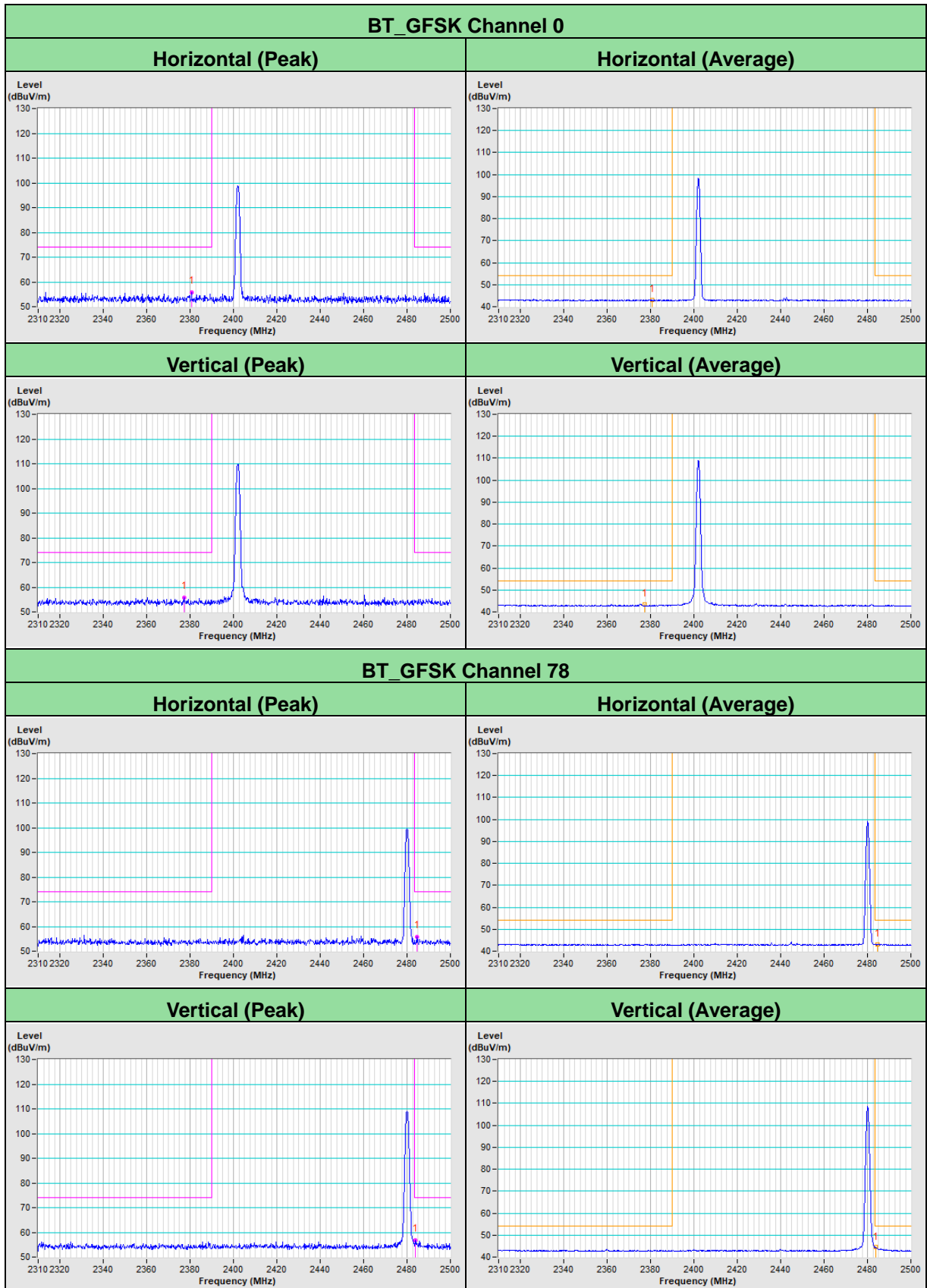

BT_8DPSK

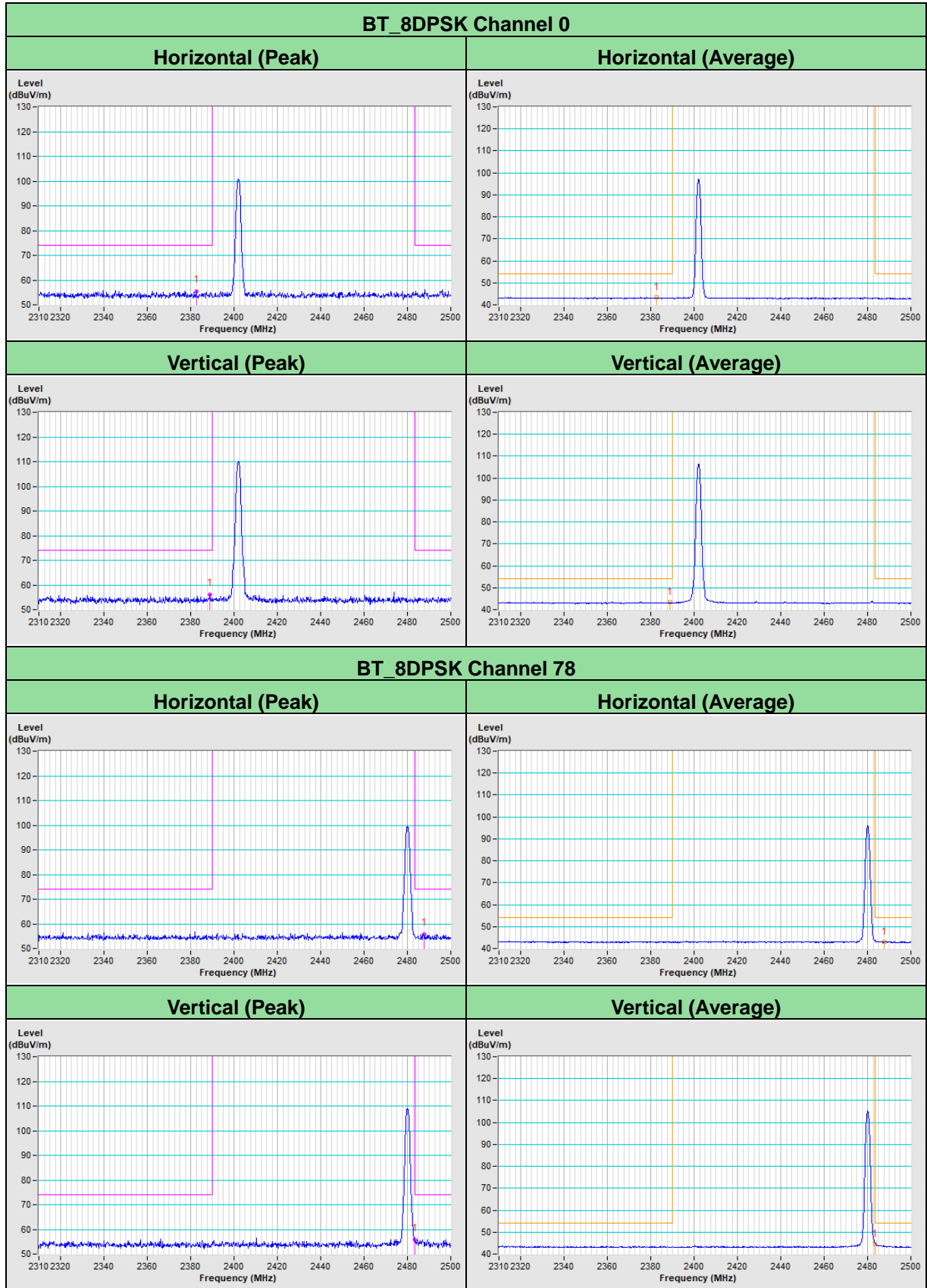

PIFA Antenna

BT_GFSK

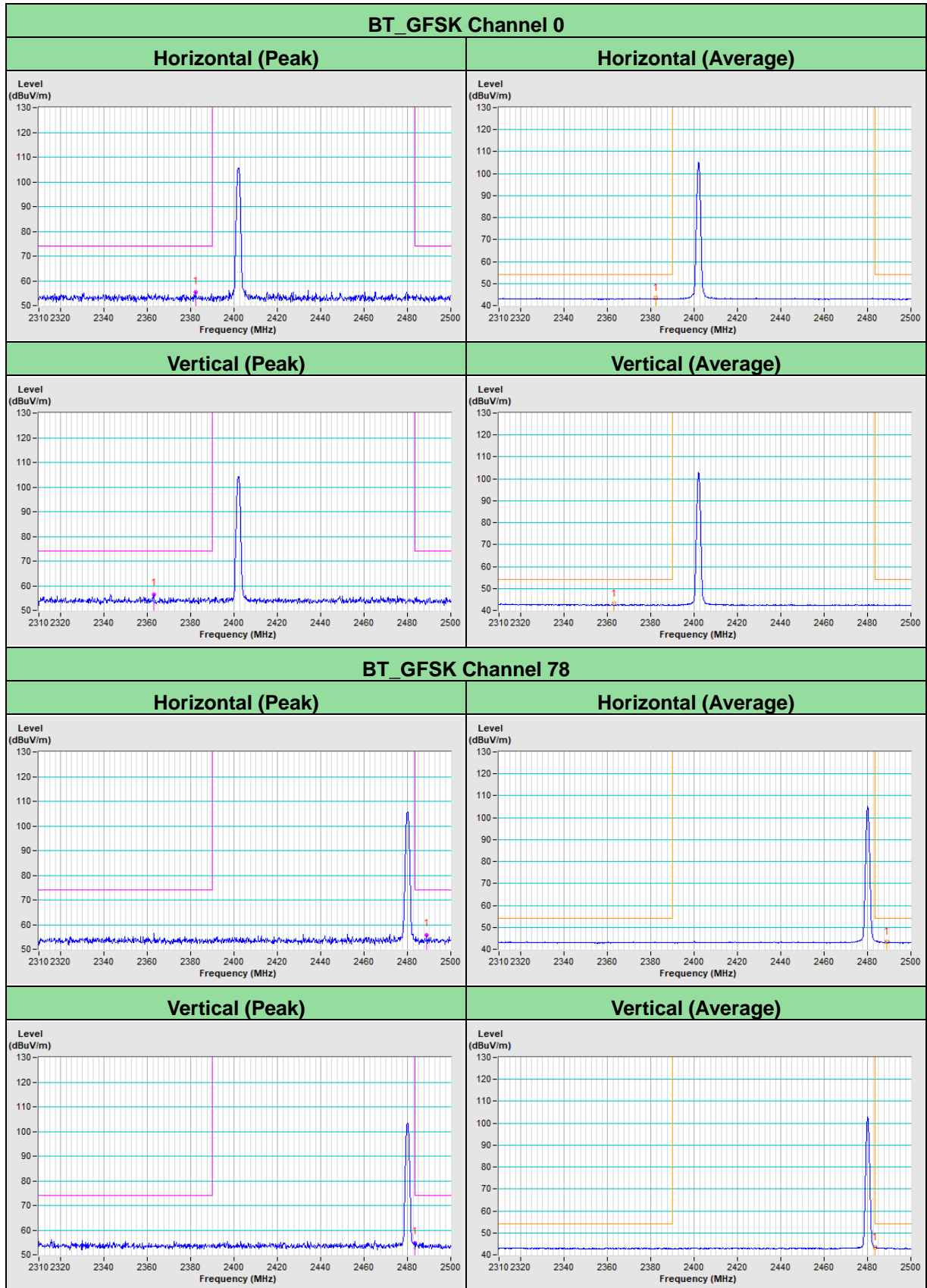

BT_8DPSK

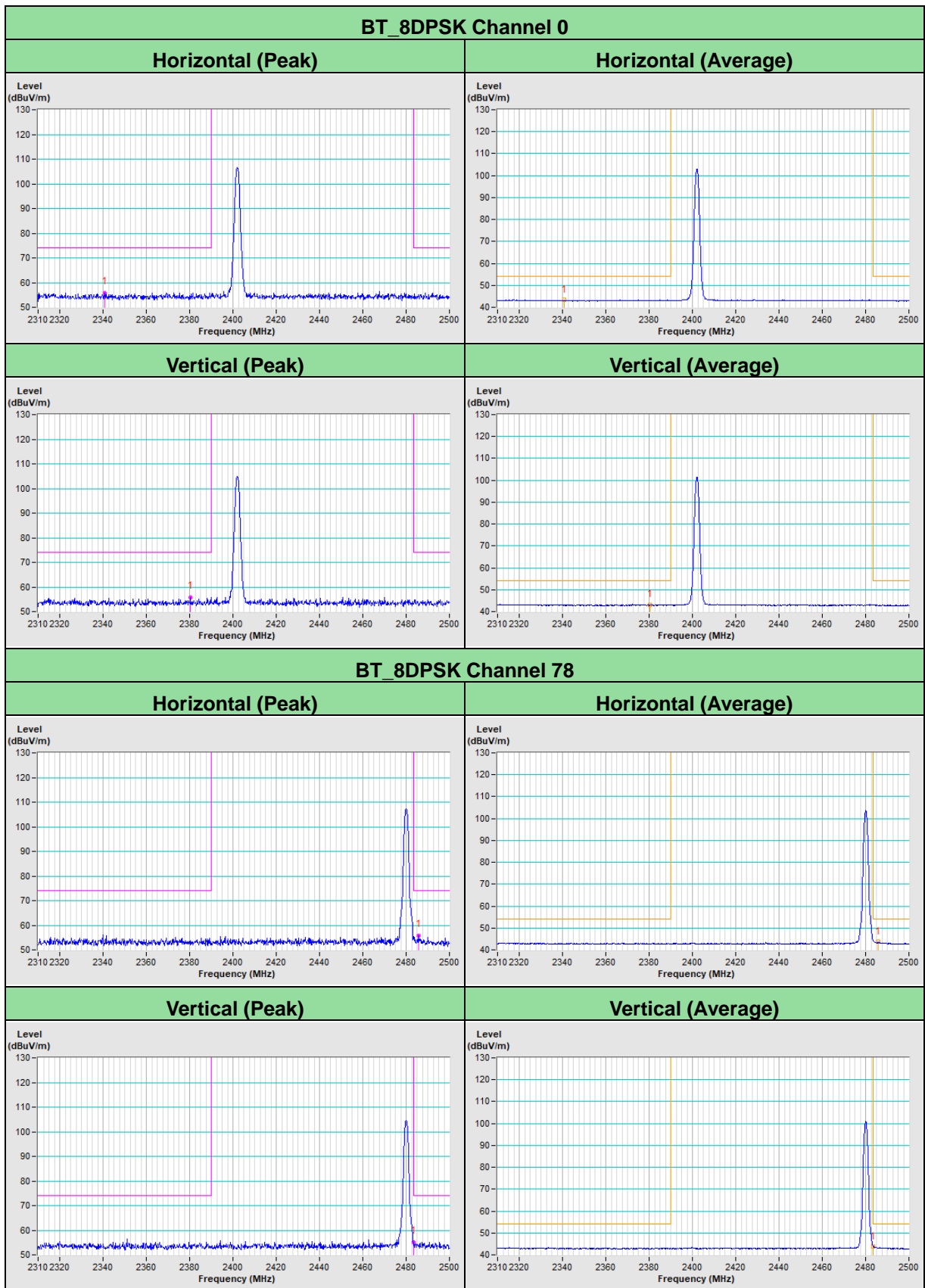

Appendix – Information of the Testing Laboratories

We, Bureau Veritas Consumer Products Services (H.K.) Ltd., Taoyuan Branch, were founded in 1988 to provide our best service in EMC, Radio, Telecom and Safety consultation. Our laboratories are FCC recognized accredited test firms and accredited according to ISO/IEC 17025.

If you have any comments, please feel free to contact us at the following:

Lin Kou EMC/RF Lab

Tel: 886-2-26052180

Fax: 886-2-26051924

Hsin Chu EMC/RF/Telecom Lab

Tel: 886-3-6668565

Fax: 886-3-6668323

Hwa Ya EMC/RF/Safety Lab

Tel: 886-3-3183232

Fax: 886-3-3270892

Email: service.adt@tw.bureauveritas.com

Web Site: www.bureauveritas-adt.com

The address and road map of all our labs can be found in our web site also.

--- END ---