

FCC Test Report (BT-LE)

Report No.: RFBBUI-WTW-P21040655-3

FCC ID: TX2-RTL8852BE

Test Model: RTL8852BE

Received Date: Apr. 20, 2021

Test Date: June 09 to July 05, 2021

Issued Date: Aug. 02, 2021

Applicant: Realtek Semiconductor Corp.

Address: No. 2, Innovation Road II, Hsinchu Science Park, Hsinchu 300, Taiwan

Issued By: Bureau Veritas Consumer Products Services (H.K.) Ltd., Taoyuan Branch
Hsin Chu Laboratory

Lab Address: E-2, No.1, Li Hsin 1st Road, Hsinchu Science Park, Hsinchu City 300,
Taiwan

Test Location: E-2, No.1, Li Hsin 1st Road, Hsinchu Science Park, Hsinchu City 300,
Taiwan

**FCC Registration /
Designation Number:** 723255 / TW2022



This report is for your exclusive use. Any copying or replication of this report to or for any other person or entity, or use of our name or trademark, is permitted only with our prior written permission. This report sets forth our findings solely with respect to the test samples identified herein. The results set forth in this report are not indicative or representative of the quality or characteristics of the lot from which a test sample was taken or any similar or identical product unless specifically and expressly noted. Our report includes all of the tests requested by you and the results thereof based upon the information that you provided to us. You have 60 days from date of issuance of this report to notify us of any material error or omission caused by our negligence, provided, however, that such notice shall be in writing and shall specifically address the issue you wish to raise. A failure to raise such issue within the prescribed time shall constitute your unqualified acceptance of the completeness of this report, the tests conducted and the correctness of the report contents. Unless specific mention, the uncertainty of measurement has been explicitly taken into account to declare the compliance or non-compliance to the specification.

Table of Contents

Release Control Record	4
1 Certificate of Conformity	5
2 Summary of Test Results	6
2.1 Measurement Uncertainty.....	6
2.2 Modification Record	6
3 General Information	7
3.1 General Description of EUT (BT-LE).....	7
3.2 Description of Test Modes.....	9
3.2.1 Test Mode Applicability and Tested Channel Detail.....	10
3.3 Duty Cycle of Test Signal	12
3.4 Description of Support Units	13
3.4.1 Configuration of System under Test	14
3.5 General Description of Applied Standards and references.....	15
4 Test Types and Results	16
4.1 Radiated Emission and Bandedge Measurement.....	16
4.1.1 Limits of Radiated Emission and Bandedge Measurement	16
4.1.2 Test Instruments	17
4.1.3 Test Procedures.....	19
4.1.4 Deviation from Test Standard	19
4.1.5 Test Setup.....	20
4.1.6 EUT Operating Conditions.....	21
4.1.7 Test Results (Mode 1).....	22
4.1.8 Test Results (Mode 2).....	38
4.2 Conducted Emission Measurement	54
4.2.1 Limits of Conducted Emission Measurement.....	54
4.2.2 Test Instruments	54
4.2.3 Test Procedures.....	55
4.2.4 Deviation from Test Standard	55
4.2.5 Test Setup.....	55
4.2.6 EUT Operating Conditions.....	55
4.2.7 Test Results (Mode 1).....	56
4.2.8 Test Results (Mode 2).....	58
4.3 6dB Bandwidth Measurement	60
4.3.1 Limits of 6dB Bandwidth Measurement.....	60
4.3.2 Test Setup.....	60
4.3.3 Test Instruments	60
4.3.4 Test Procedure	60
4.3.5 Deviation from Test Standard	60
4.3.6 EUT Operating Conditions.....	60
4.3.7 Test Results (Mode 1).....	61
4.3.8 Test Results (Mode 2).....	63
4.4 Conducted Output Power Measurement.....	65
4.4.1 Limits OF Conducted Output Power Measurement	65
4.4.2 Test Setup.....	65
4.4.3 Test Instruments	65
4.4.4 Test Procedures.....	65
4.4.5 Deviation from Test Standard	65
4.4.6 EUT Operating Conditions.....	65
4.4.7 Test Results (Mode 1).....	66
4.4.8 Test Results (Mode 2).....	67
4.5 Power Spectral Density Measurement.....	68
4.5.1 Limits of Power Spectral Density Measurement	68
4.5.2 Test Setup.....	68

4.5.3 Test Instruments	68
4.5.4 Test Procedure	68
4.5.5 Deviation from Test Standard	68
4.5.6 EUT Operating Condition	68
4.5.7 Test Results (Mode 1).....	69
4.5.8 Test Results (Mode 2).....	71
4.6 Conducted Out of Band Emission Measurement.....	73
4.6.1 Limits of Conducted Out of Band Emission Measurement	73
4.6.2 Test Setup.....	73
4.6.3 Test Instruments	73
4.6.4 Test Procedure	73
4.6.5 Deviation from Test Standard	73
4.6.6 EUT Operating Condition	73
4.6.7 Test Results (Mode 1).....	74
4.6.8 Test Results (Mode 2).....	76
5 Pictures of Test Arrangements.....	78
Annex A - Band-Edge Measurement.....	79
Annex A.1 - Test Results (Mode 1).....	79
Annex A.2 - Test Results (Mode 2).....	83
Appendix – Information of the Testing Laboratories	87



Release Control Record

Issue No.	Description	Date Issued
RFBBUI-WTW-P21040655-3	Original release.	Aug. 02, 2021

1 Certificate of Conformity

Product: 11ax RTL8852BE Combo module

Brand: REALTEK

Test Model: RTL8852BE

Sample Status: ENGINEERING SAMPLE

Applicant: Realtek Semiconductor Corp.

Test Date: June 09 to July 05, 2021

Standards: 47 CFR FCC Part 15, Subpart C (Section 15.247)
ANSI C63.10: 2013

The above equipment has been tested by **Bureau Veritas Consumer Products Services (H.K.) Ltd., Taoyuan Branch**, and found compliance with the requirement of the above standards. The test record, data evaluation & Equipment Under Test (EUT) configurations represented herein are true and accurate accounts of the measurements of the sample's EMC characteristics under the conditions specified in this report.

Prepared by :



Claire Kuan / Specialist

Date:

Aug. 02, 2021

Approved by :



Clark Lin / Technical Manager

Date:

Aug. 02, 2021

2 Summary of Test Results

47 CFR FCC Part 15, Subpart C (SECTION 15.247)			
FCC Clause	Test Item	Result	Remarks
15.207	AC Power Conducted Emission	PASS	Meet the requirement of limit. Minimum passing margin is -13.63dB at 0.15781MHz.
15.205 & 209 & 15.247(d)	Radiated Emissions & Band Edge Measurement	PASS	Meet the requirement of limit. Minimum passing margin is -5.2dB at 120.08MHz, 120.36MHz.
15.247(d)	Antenna Port Emission	PASS	Meet the requirement of limit.
15.247(a)(2)	6dB bandwidth	PASS	Meet the requirement of limit.
15.247(b)	Conducted power	PASS	Meet the requirement of limit.
15.247(e)	Power Spectral Density	PASS	Meet the requirement of limit.
15.203	Antenna Requirement	PASS	Antenna connector is i-pex(MHF) not a standard connector.

Note:

- For 2.4GHz band compliance with rule 15.247(d) of the band-edge items, the test plots were recorded in Annex A. Test Procedures refer to report 4.1.3.
- Determining compliance based on the results of the compliance measurement, not taking into account measurement instrumentation uncertainty.

2.1 Measurement Uncertainty

Where relevant, the following measurement uncertainty levels have been estimated for tests performed on the EUT as specified in CISPR 16-4-2:

Measurement	Frequency	Expanded Uncertainty (k=2) (±)
Conducted Emissions at mains ports	150kHz ~ 30MHz	1.9 dB
Conducted emissions	-	2.5 dB
Radiated Emissions up to 1 GHz	9kHz ~ 30MHz	3.1 dB
	30MHz ~ 1GHz	5.1 dB
Radiated Emissions above 1 GHz	1GHz ~ 18GHz	5.1 dB
	18GHz ~ 40GHz	5.3 dB

2.2 Modification Record

There were no modifications required for compliance.

3 General Information

3.1 General Description of EUT (BT-LE)

Product	11ax RTL8852BE Combo module
Brand	REALTEK
Test Model	RTL8852BE
Status of EUT	ENGINEERING SAMPLE
Power Supply Rating	3.3Vdc from host equipment
Modulation Type	GFSK
Modulation Technology	DTS
Transfer Rate	Up to 2Mbps
Operating Frequency	2402MHz ~ 2480MHz
Number of Channel	40
Output Power	BT-LE 1M: 17.947 mW BT-LE 2M: 18.030 mW
Antenna Type	Refer to Note
Antenna Connector	Refer to Note
Accessory Device	NA
Data Cable Supplied	NA

Note:

1. The EUT has below HW SKU configuration, as below table:

SKU No.	Interface	Description
1	PCIe + USB	Single antenna port
2	PCIe + USB	Dual antenna port
3	PCIe + UART	Dual antenna port

Note: From the above HW SKUs, for conducted emission & radiated below 1GHz the worse case was found in **SKU No.: 3** and other test items the worse case was found in **SKU No.: 2**. Therefore only the test data of the SKU was recorded in this report.

2. Simultaneously transmission condition.

Condition	Technology	
1	WLAN 5GHz	Bluetooth

Note: The emission of the simultaneous operation has been evaluated and no non-compliance was found.

3. The antennas provided to the EUT, please refer to the following table:

Ant. Set	RF Chain No.	Brand	Model	Ant. Net Gain (dBi)	Frequency Range (GHz)	Ant. Type	Connector Type	Cable Length (mm)
1	Chain 0	ARISTOTLE	RFA-27-JP326-MHF4300	3.5	2.4~2.4835	PIFA	i-pex(MHF)	300
				5	5.15~5.85			
				5	5.875~7.125			
	Chain 1	ARISTOTLE	RFA-27-JP326-MHF4300	3.5	2.4~2.4835	PIFA	i-pex(MHF)	300
				5	5.15~5.85			
				5	5.875~7.125			
2	Chain 0	ARISTOTLE	RFA-27-C38H1-MHF4300	3	2.4~2.4835	Dipole	i-pex(MHF)	300
				5	5.15~5.85			
				5	5.875~7.125			
	Chain 1	ARISTOTLE	RFA-27-C38H1-MHF4300	3	2.4~2.4835	Dipole	i-pex(MHF)	300
				5	5.15~5.85			
				5	5.875~7.125			

Note:

1. The Bluetooth technology will fix transmission on Chain 1.
2. Max. gain was selected for the final test, except for the radiated emissions test.

4. The above EUT information is declared by manufacturer and for more detailed features description, please refers to the manufacturer's specifications or user's manual.
5. The above Antenna information is declared by manufacturer and for more detailed features description, please refer to the manufacturer's specifications, the laboratory shall not be held responsible.

3.2 Description of Test Modes

40 channels are provided to this EUT:

RF Channel	RF Center Frequency	Channel Index	Channels Type for BT 5.x		Channels Type for BT 4.x
			Maximum Data Rate 2Mbps	Maximum Data Rate 1Mbps	Maximum Data Rate 1Mbps
0	2402 MHz	37		●	●
1	2404 MHz	0	●		●
2	2406 MHz	1	●		●
3	2408 MHz	2	●		●
4	2410 MHz	3	●		●
5	2412 MHz	4	●		●
6	2414 MHz	5	●		●
7	2416 MHz	6	●		●
8	2418 MHz	7	●		●
9	2420 MHz	8	●		●
10	2422 MHz	9	●		●
11	2424 MHz	10	●		●
12	2426 MHz	38		●	●
13	2428 MHz	11	●		●
14	2430 MHz	12	●		●
15	2432 MHz	13	●		●
16	2434 MHz	14	●		●
17	2436 MHz	15	●		●
18	2438 MHz	16	●		●
19	2440 MHz	17	●		●
20	2442 MHz	18	●		●
21	2444 MHz	19	●		●
22	2446 MHz	20	●		●
23	2448 MHz	21	●		●
24	2450 MHz	22	●		●
25	2452 MHz	23	●		●
26	2454 MHz	24	●		●
27	2456 MHz	25	●		●
28	2458 MHz	26	●		●
29	2460 MHz	27	●		●
30	2462 MHz	28	●		●
31	2464 MHz	29	●		●
32	2466 MHz	30	●		●
33	2468 MHz	31	●		●
34	2470 MHz	32	●		●
35	2472 MHz	33	●		●
36	2474 MHz	34	●		●
37	2476 MHz	35	●		●
38	2478 MHz	36	●		●
39	2480 MHz	39		●	●

3.2.1 Test Mode Applicability and Tested Channel Detail

EUT CONFIGURE MODE	APPLICABLE TO				DESCRIPTION
	RE≥1G	RE<1G	PLC	APCM	
1	√	√	√	√	Low power
2	√	√	√	√	High power

Where **RE≥1G**: Radiated Emission above 1GHz **RE<1G**: Radiated Emission below 1GHz
PLC: Power Line Conducted Emission **APCM**: Antenna Port Conducted Measurement

Note: The EUT's PIFA antenna had been pre-tested on the positioned of each 3 axis. The worst case was found when positioned on X-plane.

Radiated Emission Test (Above 1GHz):

- Pre-Scan has been conducted to determine the worst-case mode from all possible combinations between available modulations, data rates and antenna ports (if EUT with antenna diversity architecture).
- Following channel(s) was (were) selected for the final test as listed below.

AVAILABLE CHANNEL	TESTED CHANNEL	MODULATION TYPE	DATA RATE (Mbps)
0 to 39	0, 19, 39	GFSK	1
1 to 38	1, 19, 38	GFSK	2

Radiated Emission Test (Below 1GHz):

- Pre-Scan has been conducted to determine the worst-case mode from all possible combinations between available modulations, data rates and antenna ports (if EUT with antenna diversity architecture).
- Following channel(s) was (were) selected for the final test as listed below.

AVAILABLE CHANNEL	TESTED CHANNEL	MODULATION TYPE	DATA RATE (Mbps)
1 to 38	1	GFSK	2

Power Line Conducted Emission Test:

- Pre-Scan has been conducted to determine the worst-case mode from all possible combinations between available modulations, data rates and antenna ports (if EUT with antenna diversity architecture).
- Following channel(s) was (were) selected for the final test as listed below.

AVAILABLE CHANNEL	TESTED CHANNEL	MODULATION TYPE	DATA RATE (Mbps)
1 to 38	1	GFSK	2

Antenna Port Conducted Measurement:

- This item includes all test value of each mode, but only includes spectrum plot of worst value of each mode.
- Pre-Scan has been conducted to determine the worst-case mode from all possible combinations between available modulations, data rates and antenna ports (if EUT with antenna diversity architecture).
- Following channel(s) was (were) selected for the final test as listed below.

AVAILABLE CHANNEL	TESTED CHANNEL	MODULATION TYPE	DATA RATE (Mbps)
0 to 39	0, 19, 39	GFSK	1
1 to 38	1, 19, 38	GFSK	2

Test Condition:

APPLICABLE TO	ENVIRONMENTAL CONDITIONS	Input Power (System)	TESTED BY
RE \geq 1G	24deg. C, 66%RH 25deg. C, 67%RH	120Vac, 60Hz	Tom Yang Sampson Chen
RE<1G	25deg. C, 71%RH	120Vac, 60Hz	Sampson Chen
PLC	25deg. C, 65%RH	120Vac, 60Hz	Sampson Chen
APCM	25deg. C, 60%RH	120Vac, 60Hz	Kevin Ko

3.3 Duty Cycle of Test Signal

BT-LE 1M

Duty cycle = $0.39 \text{ ms} / 0.625 \text{ ms} = 0.624$, Duty factor = $10 * \log(1 / \text{Duty cycle}) = 2.05$

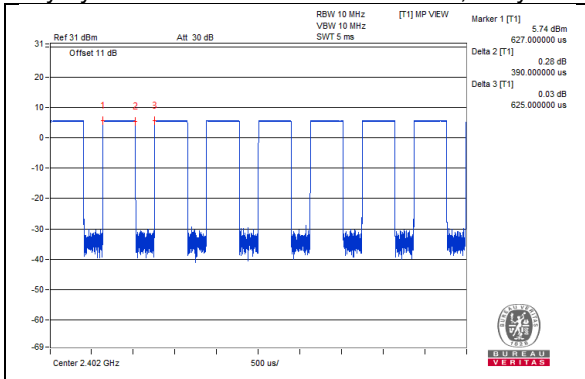

BT-LE 2M

Duty cycle = $0.206 \text{ ms} / 0.625 = 0.33$, Duty factor = $10 * \log(1 / \text{Duty cycle}) = 4.82$

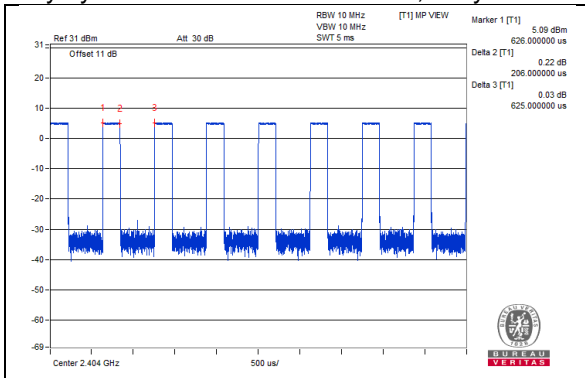

3.4 Description of Support Units

The EUT has been tested as an independent unit together with other necessary accessories or support units. The following support units or accessories were used to form a representative test configuration during the tests.

ID	Product	Brand	Model No.	Serial No.	FCC ID	Remarks
A.	Laptop	DELL	E6420	B92T3R1	NA	Provided by Lab
B.	Test Tool	Realtek	NA	NA	NA	Supplied by client
C.	Adapter	DELL	LA65NS2-01	NA	NA	Provided by Lab

ID	Descriptions	Qty.	Length (m)	Shielding (Yes/No)	Cores (Qty.)	Remarks
1.	DC Cable	1	1.8	No	1	Provided by Lab
2.	AC Cable	1	1	No	0	Provided by Lab

Note: The core is originally attached to the cable.

3.4.1 Configuration of System under Test
For AC Power Conducted Emissions test:

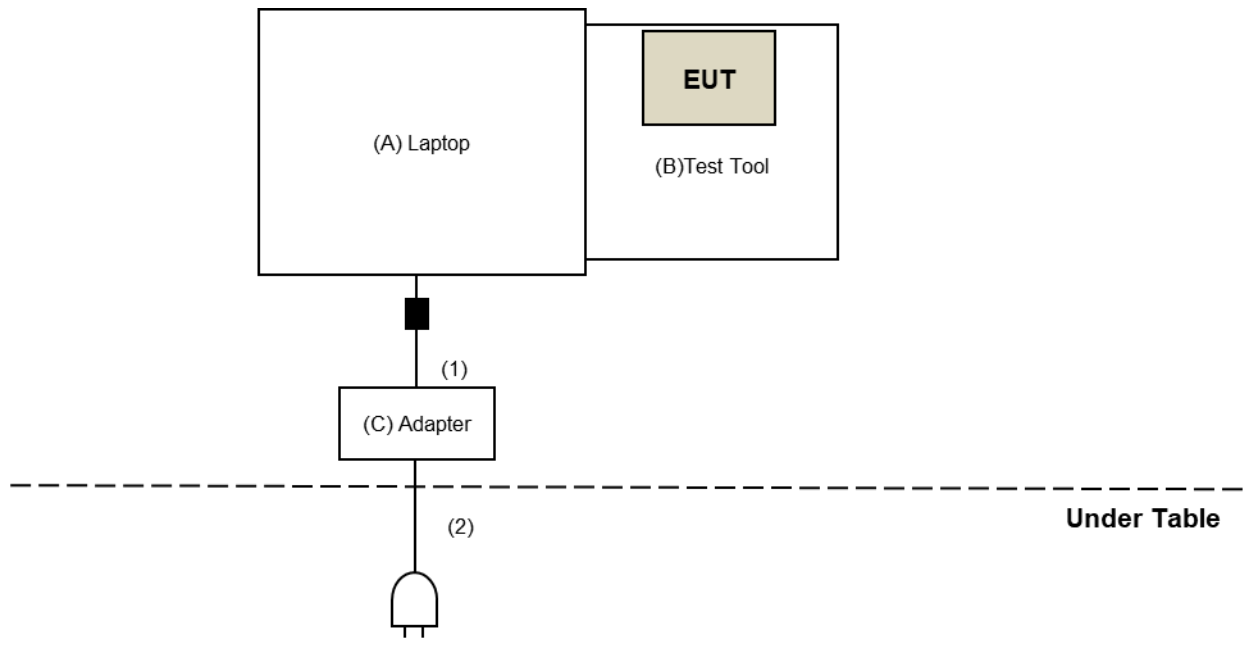

For Radiated Emissions test:

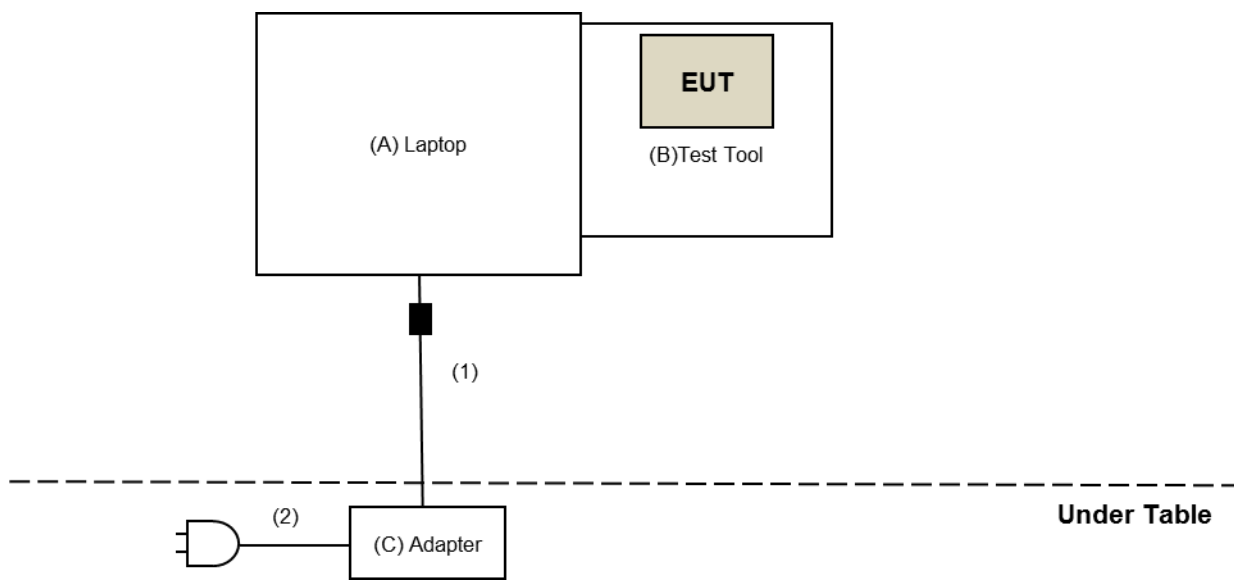

3.5 General Description of Applied Standards and references

The EUT is a RF Product. According to the specifications of the manufacturer, it must comply with the requirements of the following standards and references:

Test standard:

FCC Part 15, Subpart C (15.247)

ANSI C63.10-2013

All test items have been performed and recorded as per the above standards.

References Test Guidance:

KDB 558074 D01 15.247 Meas Guidance v05r02

All test items have been performed as a reference to the above KDB test guidance.

4 Test Types and Results

4.1 Radiated Emission and Bandedge Measurement

4.1.1 Limits of Radiated Emission and Bandedge Measurement

Radiated emissions which fall in the restricted bands must comply with the radiated emission limits specified as below table. Other emissions shall be at least 20dB below the highest level of the desired power:

Frequencies (MHz)	Field Strength (microvolts/meter)	Measurement Distance (meters)
0.009 ~ 0.490	2400/F(kHz)	300
0.490 ~ 1.705	24000/F(kHz)	30
1.705 ~ 30.0	30	30
30 ~ 88	100	3
88 ~ 216	150	3
216 ~ 960	200	3
Above 960	500	3

NOTE:

1. The lower limit shall apply at the transition frequencies.
2. Emission level (dBuV/m) = 20 log Emission level (uV/m).
3. For frequencies above 1000MHz, the field strength limits are based on average detector, however, the peak field strength of any emission shall not exceed the maximum permitted average limits, specified above by more than 20dB under any condition of modulation.

4.1.2 Test Instruments

For Radiated Emission and Bandedge test:

DESCRIPTION & MANUFACTURER	MODEL NO.	SERIAL NO.	CALIBRATED DATE	CALIBRATED UNTIL
Test Receiver R&S	ESR3	102528	Mar. 02, 2021	Mar. 01, 2022
Spectrum Analyzer Keysight	N9030B	MY57141948	May 21, 2021	May 20, 2022
Pre-Amplifier EMCI	EMC001340	980142	May 24, 2021	May 23, 2022
Loop Antenna Electro-Metrics	EM-6879	264	Mar. 05, 2021	Mar. 04, 2022
RF Cable	5D-FB	LOOPCAB-001	Jan. 07, 2021	Jan. 06, 2022
RF Cable	5D-FB	LOOPCAB-002	Jan. 07, 2021	Jan. 06, 2022
Pre-Amplifier EMCI	EMC330N	980538	Apr. 26, 2021	Apr. 25, 2022
Trilog Broadband Antenna SCHWARZBECK	VULB9168	9168-0842	Nov. 03, 2020	Nov. 02, 2021
RF Cable	8D	966-5-1	Apr. 26, 2021	Apr. 25, 2022
RF Cable	8D	966-5-2	Apr. 26, 2021	Apr. 25, 2022
RF Cable	8D	966-5-3	Apr. 26, 2021	Apr. 25, 2022
Fixed attenuator Mini-Circuits	UNAT-5+	PAD-ATT5-02	Jan. 11, 2021	Jan. 10, 2022
Horn_Antenna SCHWARZBECK	BBHA 9120D	9120D-1819	Nov. 22, 2020	Nov. 21, 2021
Pre-Amplifier EMCI	EMC12630SE	980509	Apr. 26, 2021	Apr. 25, 2022
RF Cable EMCI	EMC104-SM-SM-1500	180503	Apr. 26, 2021	Apr. 25, 2022
RF Cable EMCI	EMC104-SM-SM-2000	180501	Apr. 26, 2021	Apr. 25, 2022
RF Cable EMCI	EMC104-SM-SM-6000	180506	Apr. 26, 2021	Apr. 25, 2022
Pre-Amplifier EMCI	EMC184045SE	980387	Jan. 11, 2021	Jan. 10, 2022
Horn_Antenna SCHWARZBECK	BBHA 9170	BBHA9170519	Nov. 22, 2020	Nov. 21, 2021
RF Cable	EMC102-KM-KM-1200	160924	Jan. 11, 2021	Jan. 10, 2022
RF Cable	EMC-KM-KM-4000	200214	Mar. 10, 2021	Mar. 09, 2022
Software	ADT_Radiated_V8.7.08	NA	NA	NA
Boresight Antenna Tower & Turn Table Max-Full	MF-7802BS	MF780208530	NA	NA

Note:

1. The calibration interval of the above test instruments is 12 months and the calibrations are traceable to NML/ROC and NIST/USA.
2. The test was performed in 966 Chamber No. 5.
3. Tested Date: June 09 to July 02, 2021

For other test items:

DESCRIPTION & MANUFACTURER	MODEL NO.	SERIAL NO.	CALIBRATED DATE	CALIBRATED UNTIL
Spectrum Analyzer R&S	FSV40	101516	Mar. 08, 2021	Mar. 07, 2022
Power meter Anritsu	ML2495A	1529002	July 22, 2020	July 21, 2021
Power sensor Anritsu	MA2411B	1339443	May 31, 2021	May 30, 2022
10dB Attenuator Woken	MDCS18N-10	MDCS18N-10-01	Apr. 13, 2021	Apr. 12, 2022
Software	ADT_RF Test Software V6.6.5.4	NA	NA	NA

- NOTE:**
1. The test was performed in Oven room 2.
 2. The calibration interval of the above test instruments is 12 months and the calibrations are traceable to NML/ROC and NIST/USA.
 3. Tested Date: July 05, 2021

4.1.3 Test Procedures

For Radiated emission below 30MHz

- a. The EUT was placed on the top of a rotating table 0.8 meters above the ground at a 3 meter chamber room. The table was rotated 360 degrees to determine the position of the highest radiation.
- b. The EUT was set 3 meters away from the interference-receiving antenna, which was mounted on the top of a variable-height antenna tower.
- c. Parallel, perpendicular, and ground-parallel orientations of the antenna are set to make the measurement.
- d. For each suspected emission, the EUT was arranged to its worst case and the rotatable table was turned from 0 degrees to 360 degrees to find the maximum reading.
- e. The test-receiver system was set to Quasi-Peak Detect Function and Specified Bandwidth with Maximum Hold Mode.

NOTE:

1. The resolution bandwidth and video bandwidth of test receiver/spectrum analyzer is 9kHz at frequency below 30MHz.

For Radiated emission above 30MHz

- a. The EUT was placed on the top of a rotating table 0.8 meters (for 30MHz ~ 1GHz) / 1.5 meters (for above 1GHz) above the ground at 3 meter chamber room for test. The table was rotated 360 degrees to determine the position of the highest radiation.
- b. The EUT was set 3 meters away from the interference-receiving antenna, which was mounted on the top of a variable-height antenna tower.
- c. The height of antenna is varied from one meter to four meters above the ground to determine the maximum value of the field strength. Both horizontal and vertical polarizations of the antenna are set to make the measurement.
- d. For each suspected emission, the EUT was arranged to its worst case and then the antenna was tuned to heights from 1 meter to 4 meters and the rotatable table was turned from 0 degrees to 360 degrees to find the maximum reading.
- e. The test-receiver system was set to quasi-peak detect function and specified bandwidth with maximum hold mode when the test frequency is below 1 GHz.
- f. The test-receiver system was set to peak and average detect function and specified bandwidth with maximum hold mode when the test frequency is above 1 GHz. If the peak reading value also meets average limit, measurement with the average detector is unnecessary.

Note:

1. The resolution bandwidth and video bandwidth of test receiver/spectrum analyzer is 120kHz for Quasi-peak detection (QP) at frequency below 1GHz.
2. The resolution bandwidth of test receiver/spectrum analyzer is 1 MHz and the video bandwidth is 3 MHz for Peak detection (PK) at frequency above 1GHz.
3. The resolution bandwidth of test receiver/spectrum analyzer is 1 MHz and the video bandwidth is 3 MHz for Average detection (AV) at frequency above 1GHz.
4. All modes of operation were investigated and the worst-case emissions are reported.

4.1.4 Deviation from Test Standard

No deviation.

4.1.5 Test Setup

For Radiated emission below 30MHz

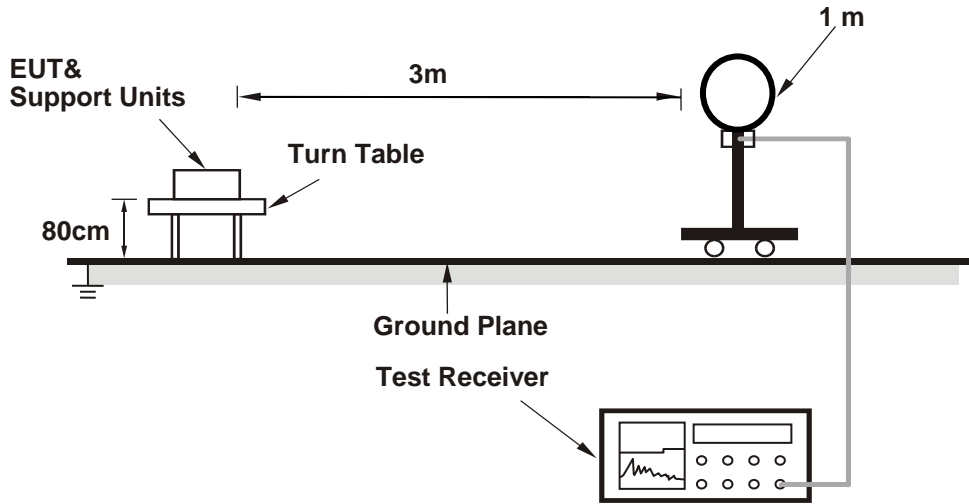

For Radiated emission 30MHz to 1GHz

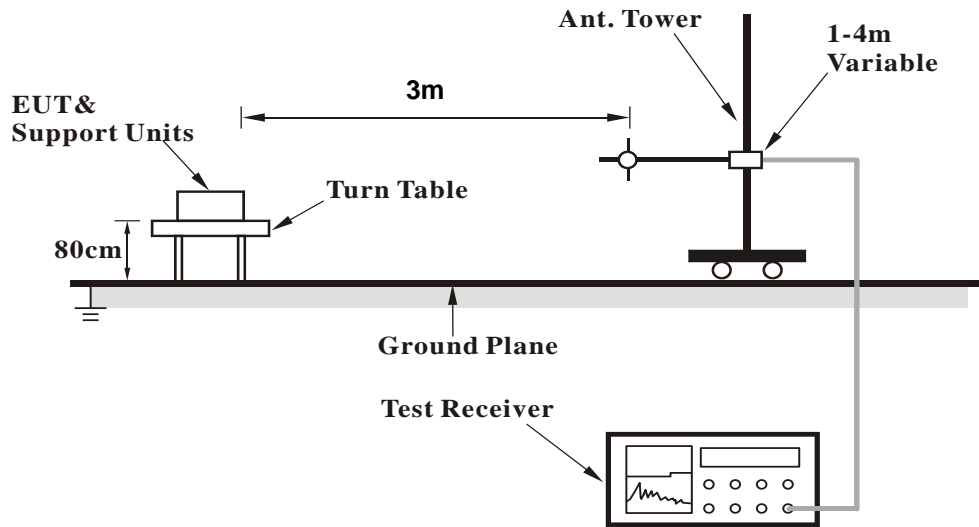

For Radiated emission above 1GHz

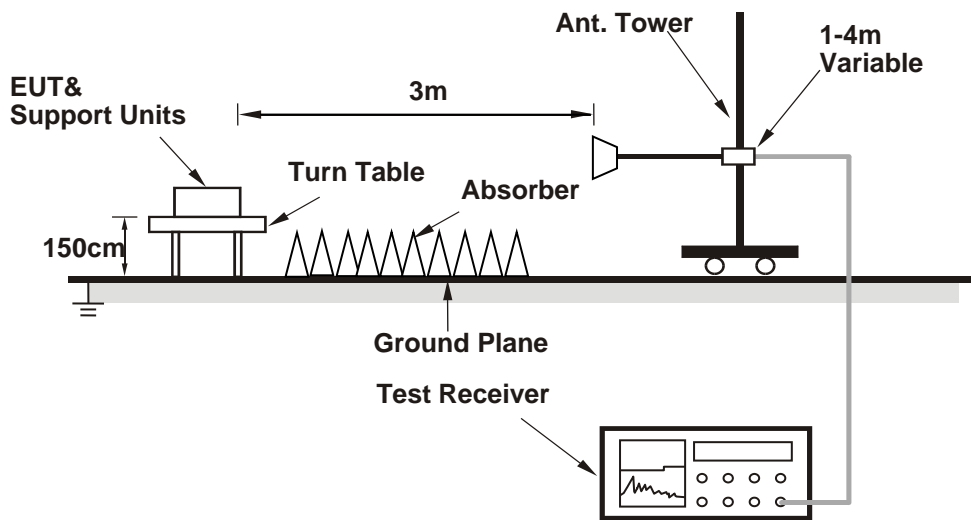

For the actual test configuration, please refer to the attached file (Test Setup Photo).

4.1.6 EUT Operating Conditions

- a. Placed the EUT on the testing table.
- b. Controlling software (Bluetooth RF test tool (5.2.3.1)) has been activated to set the EUT under transmission condition continuously at specific channel frequency.

4.1.7 Test Results (Mode 1)

Dipole Antenna

Above 1GHz Data :

BT-LE 1M

RF Mode	TX BT_LE-1M	Channel	CH 0 : 2402 MHz
Frequency Range	1GHz ~ 25GHz	Detector Function	Peak (PK) Average (AV)

Antenna Polarity & Test Distance : Horizontal at 3 m

No	Frequency (MHz)	Emission Level (dBuV/m)	Limit (dBuV/m)	Margin (dB)	Antenna Height (m)	Table Angle (Degree)	Raw Value (dBuV)	Correction Factor (dB/m)
1	2378.40	56.0 PK	74.0	-18.0	1.08 H	143	58.6	-2.6
2	2378.40	44.3 AV	54.0	-9.7	1.08 H	143	46.9	-2.6
3	*2402.00	92.9 PK			1.08 H	143	95.6	-2.7
4	*2402.00	91.8 AV			1.08 H	143	94.5	-2.7
5	4804.00	36.1 PK	74.0	-37.9	1.46 H	173	34.3	1.8
6	4804.00	29.2 AV	54.0	-24.8	1.46 H	173	27.4	1.8

Antenna Polarity & Test Distance : Vertical at 3 m

No	Frequency (MHz)	Emission Level (dBuV/m)	Limit (dBuV/m)	Margin (dB)	Antenna Height (m)	Table Angle (Degree)	Raw Value (dBuV)	Correction Factor (dB/m)
1	2369.70	55.3 PK	74.0	-18.7	1.65 V	254	58.0	-2.7
2	2369.70	44.3 AV	54.0	-9.7	1.65 V	254	47.0	-2.7
3	*2402.00	103.1 PK			1.65 V	254	105.8	-2.7
4	*2402.00	102.0 AV			1.65 V	254	104.7	-2.7
5	4804.00	42.4 PK	74.0	-31.6	1.22 V	286	40.6	1.8
6	4804.00	35.3 AV	54.0	-18.7	1.22 V	286	33.5	1.8

Remarks:

1. Emission Level(dBuV/m) = Raw Value(dBuV) + Correction Factor(dB/m)
2. Correction Factor(dB/m) = Antenna Factor(dB/m) + Cable Factor(dB) – Pre-Amplifier Factor(dB)
3. Margin value = Emission Level – Limit value
4. The other emission levels were very low against the limit.
5. " * ": Fundamental frequency.

RF Mode	TX BT_LE-1M	Channel	CH 19 : 2440 MHz
Frequency Range	1GHz ~ 25GHz	Detector Function	Peak (PK) Average (AV)

Antenna Polarity & Test Distance : Horizontal at 3 m

No	Frequency (MHz)	Emission Level (dBuV/m)	Limit (dBuV/m)	Margin (dB)	Antenna Height (m)	Table Angle (Degree)	Raw Value (dBuV)	Correction Factor (dB/m)
1	*2440.00	92.7 PK			1.07 H	143	95.4	-2.7
2	*2440.00	91.4 AV			1.07 H	143	94.1	-2.7
3	4880.00	36.2 PK	74.0	-37.8	1.57 H	176	34.5	1.7
4	4880.00	29.2 AV	54.0	-24.8	1.57 H	176	27.5	1.7
5	7320.00	46.0 PK	74.0	-28.0	1.80 H	199	38.7	7.3
6	7320.00	35.6 AV	54.0	-18.4	1.80 H	199	28.3	7.3

Antenna Polarity & Test Distance : Vertical at 3 m

No	Frequency (MHz)	Emission Level (dBuV/m)	Limit (dBuV/m)	Margin (dB)	Antenna Height (m)	Table Angle (Degree)	Raw Value (dBuV)	Correction Factor (dB/m)
1	*2440.00	103.4 PK			1.70 V	270	106.1	-2.7
2	*2440.00	102.5 AV			1.70 V	270	105.2	-2.7
3	4880.00	41.6 PK	74.0	-32.4	1.18 V	280	39.9	1.7
4	4880.00	34.5 AV	54.0	-19.5	1.18 V	280	32.8	1.7
5	7320.00	49.5 PK	74.0	-24.5	1.47 V	288	42.2	7.3
6	7320.00	41.3 AV	54.0	-12.7	1.47 V	288	34.0	7.3

Remarks:

1. Emission Level(dBuV/m) = Raw Value(dBuV) + Correction Factor(dB/m)
2. Correction Factor(dB/m) = Antenna Factor(dB/m) + Cable Factor(dB) – Pre-Amplifier Factor(dB)
3. Margin value = Emission Level – Limit value
4. The other emission levels were very low against the limit.
5. " * ": Fundamental frequency.

RF Mode	TX BT_LE-1M	Channel	CH 39 : 2480 MHz
Frequency Range	1GHz ~ 25GHz	Detector Function	Peak (PK) Average (AV)

Antenna Polarity & Test Distance : Horizontal at 3 m

No	Frequency (MHz)	Emission Level (dBuV/m)	Limit (dBuV/m)	Margin (dB)	Antenna Height (m)	Table Angle (Degree)	Raw Value (dBuV)	Correction Factor (dB/m)
1	*2480.00	92.1 PK			1.46 H	136	94.9	-2.8
2	*2480.00	90.9 AV			1.46 H	136	93.7	-2.8
3	2489.17	55.6 PK	74.0	-18.4	1.46 H	136	58.4	-2.8
4	2489.17	44.4 AV	54.0	-9.6	1.46 H	136	47.2	-2.8
5	4960.00	35.7 PK	74.0	-38.3	1.47 H	165	33.7	2.0
6	4960.00	29.1 AV	54.0	-24.9	1.47 H	165	27.1	2.0
7	7440.00	45.6 PK	74.0	-28.4	1.79 H	211	38.0	7.6
8	7440.00	35.2 AV	54.0	-18.8	1.79 H	211	27.6	7.6

Antenna Polarity & Test Distance : Vertical at 3 m

No	Frequency (MHz)	Emission Level (dBuV/m)	Limit (dBuV/m)	Margin (dB)	Antenna Height (m)	Table Angle (Degree)	Raw Value (dBuV)	Correction Factor (dB/m)
1	*2480.00	104.3 PK			1.55 V	257	107.1	-2.8
2	*2480.00	103.1 AV			1.55 V	257	105.9	-2.8
3	2483.50	56.0 PK	74.0	-18.0	1.55 V	257	58.8	-2.8
4	2483.50	44.8 AV	54.0	-9.2	1.55 V	257	47.6	-2.8
5	4960.00	42.5 PK	74.0	-31.5	1.30 V	291	40.5	2.0
6	4960.00	35.1 AV	54.0	-18.9	1.30 V	291	33.1	2.0
7	7440.00	50.2 PK	74.0	-23.8	1.53 V	268	42.6	7.6
8	7440.00	41.9 AV	54.0	-12.1	1.53 V	268	34.3	7.6

Remarks:

1. Emission Level(dBuV/m) = Raw Value(dBuV) + Correction Factor(dB/m)
2. Correction Factor(dB/m) = Antenna Factor(dB/m) + Cable Factor(dB) – Pre-Amplifier Factor(dB)
3. Margin value = Emission Level – Limit value
4. The other emission levels were very low against the limit.
5. " * ": Fundamental frequency.

BT-LE 2M

RF Mode	TX BT_LE-2M	Channel	CH 1 : 2404 MHz
Frequency Range	1GHz ~ 25GHz	Detector Function	Peak (PK) Average (AV)

Antenna Polarity & Test Distance : Horizontal at 3 m

No	Frequency (MHz)	Emission Level (dBuV/m)	Limit (dBuV/m)	Margin (dB)	Antenna Height (m)	Table Angle (Degree)	Raw Value (dBuV)	Correction Factor (dB/m)
1	2384.62	55.6 PK	74.0	-18.4	1.10 H	135	58.2	-2.6
2	2384.62	43.5 AV	54.0	-10.5	1.10 H	135	46.1	-2.6
3	*2404.00	93.2 PK			1.10 H	135	95.9	-2.7
4	*2404.00	90.2 AV			1.10 H	135	92.9	-2.7
5	4808.00	36.3 PK	74.0	-37.7	1.46 H	156	34.5	1.8
6	4808.00	29.4 AV	54.0	-24.6	1.46 H	156	27.6	1.8

Antenna Polarity & Test Distance : Vertical at 3 m

No	Frequency (MHz)	Emission Level (dBuV/m)	Limit (dBuV/m)	Margin (dB)	Antenna Height (m)	Table Angle (Degree)	Raw Value (dBuV)	Correction Factor (dB/m)
1	2388.75	56.6 PK	74.0	-17.4	1.54 V	237	59.3	-2.7
2	2388.75	43.6 AV	54.0	-10.4	1.54 V	237	46.3	-2.7
3	*2404.00	103.1 PK			1.54 V	237	105.8	-2.7
4	*2404.00	100.1 AV			1.54 V	237	102.8	-2.7
5	4808.00	42.6 PK	74.0	-31.4	1.22 V	304	40.8	1.8
6	4808.00	34.9 AV	54.0	-19.1	1.22 V	304	33.1	1.8

Remarks:

1. Emission Level(dBuV/m) = Raw Value(dBuV) + Correction Factor(dB/m)
2. Correction Factor(dB/m) = Antenna Factor(dB/m) + Cable Factor(dB) – Pre-Amplifier Factor(dB)
3. Margin value = Emission Level – Limit value
4. The other emission levels were very low against the limit.
5. " * ": Fundamental frequency.

RF Mode	TX BT_LE-2M	Channel	CH 19 : 2440 MHz
Frequency Range	1GHz ~ 25GHz	Detector Function	Peak (PK) Average (AV)

Antenna Polarity & Test Distance : Horizontal at 3 m

No	Frequency (MHz)	Emission Level (dBuV/m)	Limit (dBuV/m)	Margin (dB)	Antenna Height (m)	Table Angle (Degree)	Raw Value (dBuV)	Correction Factor (dB/m)
1	*2440.00	92.9 PK			1.05 H	151	95.6	-2.7
2	*2440.00	90.0 AV			1.05 H	151	92.7	-2.7
3	4880.00	35.7 PK	74.0	-38.3	1.48 H	167	34.0	1.7
4	4880.00	29.0 AV	54.0	-25.0	1.48 H	167	27.3	1.7
5	7320.00	46.1 PK	74.0	-27.9	1.83 H	192	38.8	7.3
6	7320.00	36.0 AV	54.0	-18.0	1.83 H	192	28.7	7.3

Antenna Polarity & Test Distance : Vertical at 3 m

No	Frequency (MHz)	Emission Level (dBuV/m)	Limit (dBuV/m)	Margin (dB)	Antenna Height (m)	Table Angle (Degree)	Raw Value (dBuV)	Correction Factor (dB/m)
1	*2440.00	103.5 PK			1.50 V	236	106.2	-2.7
2	*2440.00	100.6 AV			1.50 V	236	103.3	-2.7
3	4880.00	42.6 PK	74.0	-31.4	1.28 V	300	40.9	1.7
4	4880.00	35.3 AV	54.0	-18.7	1.28 V	300	33.6	1.7
5	7320.00	49.8 PK	74.0	-24.2	1.51 V	276	42.5	7.3
6	7320.00	41.6 AV	54.0	-12.4	1.51 V	276	34.3	7.3

Remarks:

1. Emission Level(dBuV/m) = Raw Value(dBuV) + Correction Factor(dB/m)
2. Correction Factor(dB/m) = Antenna Factor(dB/m) + Cable Factor(dB) – Pre-Amplifier Factor(dB)
3. Margin value = Emission Level – Limit value
4. The other emission levels were very low against the limit.
5. " * ": Fundamental frequency.

RF Mode	TX BT_LE-2M	Channel	CH 38 : 2478 MHz
Frequency Range	1GHz ~ 25GHz	Detector Function	Peak (PK) Average (AV)

Antenna Polarity & Test Distance : Horizontal at 3 m

No	Frequency (MHz)	Emission Level (dBuV/m)	Limit (dBuV/m)	Margin (dB)	Antenna Height (m)	Table Angle (Degree)	Raw Value (dBuV)	Correction Factor (dB/m)
1	*2478.00	92.6 PK			1.40 H	155	95.4	-2.8
2	*2478.00	89.4 AV			1.40 H	155	92.2	-2.8
3	2487.07	55.4 PK	74.0	-18.6	1.40 H	155	58.2	-2.8
4	2487.07	43.6 AV	54.0	-10.4	1.40 H	155	46.4	-2.8
5	4956.00	36.4 PK	74.0	-37.6	1.49 H	156	34.5	1.9
6	4956.00	29.7 AV	54.0	-24.3	1.49 H	156	27.8	1.9
7	7434.00	46.0 PK	74.0	-28.0	1.82 H	216	38.5	7.5
8	7434.00	35.8 AV	54.0	-18.2	1.82 H	216	28.3	7.5

Antenna Polarity & Test Distance : Vertical at 3 m

No	Frequency (MHz)	Emission Level (dBuV/m)	Limit (dBuV/m)	Margin (dB)	Antenna Height (m)	Table Angle (Degree)	Raw Value (dBuV)	Correction Factor (dB/m)
1	*2478.00	104.1 PK			1.60 V	249	106.9	-2.8
2	*2478.00	101.0 AV			1.60 V	249	103.8	-2.8
3	2484.07	55.4 PK	74.0	-18.6	1.60 V	249	58.2	-2.8
4	2484.07	44.0 AV	54.0	-10.0	1.60 V	249	46.8	-2.8
5	4956.00	42.5 PK	74.0	-31.5	1.29 V	296	40.6	1.9
6	4956.00	35.0 AV	54.0	-19.0	1.29 V	296	33.1	1.9
7	7434.00	49.8 PK	74.0	-24.2	1.54 V	288	42.3	7.5
8	7434.00	41.9 AV	54.0	-12.1	1.54 V	288	34.4	7.5

Remarks:

1. Emission Level(dBuV/m) = Raw Value(dBuV) + Correction Factor(dB/m)
2. Correction Factor(dB/m) = Antenna Factor(dB/m) + Cable Factor(dB) – Pre-Amplifier Factor(dB)
3. Margin value = Emission Level – Limit value
4. The other emission levels were very low against the limit.
5. " * ": Fundamental frequency.

Below 1GHz Data:

BT-LE 2M

RF Mode	TX BT_GFSK	Channel	CH 1 : 2404 MHz
Frequency Range	9kHz ~ 1GHz	Detector Function	Quasi-Peak (QP)

Antenna Polarity & Test Distance : Horizontal at 3 m								
No	Frequency (MHz)	Emission Level (dBuV/m)	Limit (dBuV/m)	Margin (dB)	Antenna Height (m)	Table Angle (Degree)	Raw Value (dBuV)	Correction Factor (dB/m)
1	119.45	37.5 QP	43.5	-6.0	3.00 H	360	52.6	-15.1
2	166.97	35.2 QP	43.5	-8.3	2.00 H	156	48.2	-13.0
3	226.08	33.0 QP	46.0	-13.0	2.00 H	116	48.9	-15.9
4	299.73	35.4 QP	46.0	-10.6	1.50 H	91	47.7	-12.3
5	336.04	33.4 QP	46.0	-12.6	1.50 H	325	44.7	-11.3
6	574.67	26.6 QP	46.0	-19.4	1.50 H	120	32.8	-6.2

Remarks:

1. Emission Level(dBuV/m) = Raw Value(dBuV) + Correction Factor(dB/m)
2. Correction Factor(dB/m) = Antenna Factor(dB/m) + Cable Factor(dB) – Pre-Amplifier Factor(dB)
3. Margin value = Emission Level – Limit value
4. The other emission levels were very low against the limit of frequency range 30MHz~1000MHz.
5. The emission levels were very low against the limit of frequency range 9kHz~30MHz: the amplitude of spurious emissions attenuated more than 20 dB below the permissible value to be report.

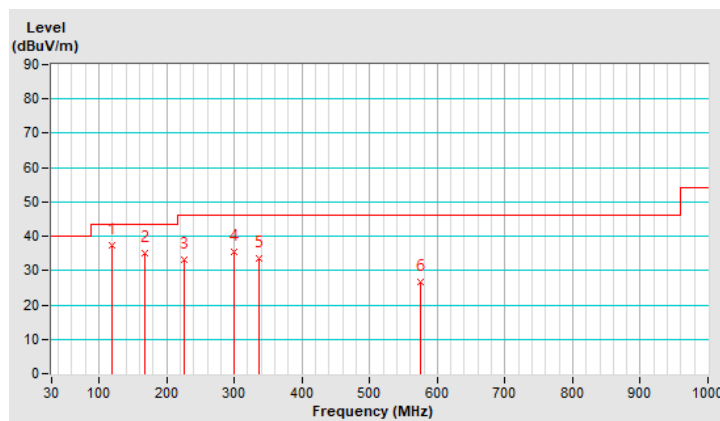

RF Mode	TX BT_GFSK	Channel	CH 1 : 2404 MHz
Frequency Range	9kHz ~ 1GHz	Detector Function	Quasi-Peak (QP)

Antenna Polarity & Test Distance : Vertical at 3 m								
No	Frequency (MHz)	Emission Level (dBuV/m)	Limit (dBuV/m)	Margin (dB)	Antenna Height (m)	Table Angle (Degree)	Raw Value (dBuV)	Correction Factor (dB/m)
1	125.53	28.7 QP	43.5	-14.8	1.00 V	41	43.2	-14.5
2	166.92	31.8 QP	43.5	-11.7	1.50 V	236	44.8	-13.0
3	224.21	31.4 QP	46.0	-14.6	1.00 V	143	47.4	-16.0
4	341.92	27.2 QP	46.0	-18.8	1.50 V	172	38.5	-11.3
5	498.61	24.5 QP	46.0	-21.5	1.50 V	51	32.2	-7.7
6	950.41	32.9 QP	46.0	-13.1	1.00 V	154	33.5	-0.6

Remarks:

1. Emission Level(dBuV/m) = Raw Value(dBuV) + Correction Factor(dB/m)
2. Correction Factor(dB/m) = Antenna Factor(dB/m) + Cable Factor(dB) – Pre-Amplifier Factor(dB)
3. Margin value = Emission Level – Limit value
4. The other emission levels were very low against the limit of frequency range 30MHz~1000MHz.
5. The emission levels were very low against the limit of frequency range 9kHz~30MHz: the amplitude of spurious emissions attenuated more than 20 dB below the permissible value to be report.

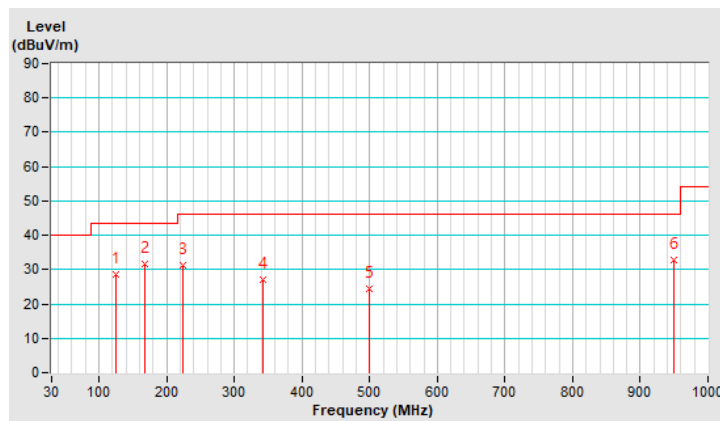

PIFA Antenna

Above 1GHz Data:

BT-LE 1M

RF Mode	TX BT_LE-1M	Channel	CH 0 : 2402 MHz
Frequency Range	1GHz ~ 25GHz	Detector Function	Peak (PK) Average (AV)

Antenna Polarity & Test Distance : Horizontal at 3 m								
No	Frequency (MHz)	Emission Level (dBuV/m)	Limit (dBuV/m)	Margin (dB)	Antenna Height (m)	Table Angle (Degree)	Raw Value (dBuV)	Correction Factor (dB/m)
1	2380.83	55.8 PK	74.0	-18.2	1.13 H	324	58.4	-2.6
2	2380.83	44.1 AV	54.0	-9.9	1.13 H	324	46.7	-2.6
3	*2402.00	100.1 PK			1.13 H	324	102.8	-2.7
4	*2402.00	98.9 AV			1.13 H	324	101.6	-2.7
5	4804.00	41.7 PK	74.0	-32.3	1.34 H	161	39.9	1.8
6	4804.00	31.9 AV	54.0	-22.1	1.34 H	161	30.1	1.8
Antenna Polarity & Test Distance : Vertical at 3 m								
No	Frequency (MHz)	Emission Level (dBuV/m)	Limit (dBuV/m)	Margin (dB)	Antenna Height (m)	Table Angle (Degree)	Raw Value (dBuV)	Correction Factor (dB/m)
1	2374.20	56.2 PK	74.0	-17.8	2.19 V	92	58.8	-2.6
2	2374.20	44.4 AV	54.0	-9.6	2.19 V	92	47.0	-2.6
3	*2402.00	97.8 PK			2.19 V	92	100.5	-2.7
4	*2402.00	96.7 AV			2.19 V	92	99.4	-2.7
5	4804.00	39.9 PK	74.0	-34.1	1.14 V	115	38.1	1.8
6	4804.00	30.1 AV	54.0	-23.9	1.14 V	115	28.3	1.8

Remarks:

1. Emission Level(dBuV/m) = Raw Value(dBuV) + Correction Factor(dB/m)
2. Correction Factor(dB/m) = Antenna Factor(dB/m) + Cable Factor(dB) – Pre-Amplifier Factor(dB)
3. Margin value = Emission Level – Limit value
4. The other emission levels were very low against the limit.
5. " * ": Fundamental frequency.

RF Mode	TX BT_LE-1M	Channel	CH 19 : 2440 MHz
Frequency Range	1GHz ~ 25GHz	Detector Function	Peak (PK) Average (AV)

Antenna Polarity & Test Distance : Horizontal at 3 m

No	Frequency (MHz)	Emission Level (dBuV/m)	Limit (dBuV/m)	Margin (dB)	Antenna Height (m)	Table Angle (Degree)	Raw Value (dBuV)	Correction Factor (dB/m)
1	*2440.00	100.6 PK			1.18 H	315	103.3	-2.7
2	*2440.00	99.4 AV			1.18 H	315	102.1	-2.7
3	4880.00	41.9 PK	74.0	-32.1	1.34 H	142	40.2	1.7
4	4880.00	32.2 AV	54.0	-21.8	1.34 H	142	30.5	1.7
5	7320.00	51.7 PK	74.0	-22.3	1.46 H	5	44.4	7.3
6	7320.00	42.4 AV	54.0	-11.6	1.46 H	5	35.1	7.3

Antenna Polarity & Test Distance : Vertical at 3 m

No	Frequency (MHz)	Emission Level (dBuV/m)	Limit (dBuV/m)	Margin (dB)	Antenna Height (m)	Table Angle (Degree)	Raw Value (dBuV)	Correction Factor (dB/m)
1	*2440.00	98.1 PK			2.15 V	86	100.8	-2.7
2	*2440.00	96.9 AV			2.15 V	86	99.6	-2.7
3	4880.00	39.5 PK	74.0	-34.5	1.05 V	88	37.8	1.7
4	4880.00	29.8 AV	54.0	-24.2	1.05 V	88	28.1	1.7
5	7320.00	46.4 PK	74.0	-27.6	3.84 V	357	39.1	7.3
6	7320.00	37.8 AV	54.0	-16.2	3.84 V	357	30.5	7.3

Remarks:

1. Emission Level(dBuV/m) = Raw Value(dBuV) + Correction Factor(dB/m)
2. Correction Factor(dB/m) = Antenna Factor(dB/m) + Cable Factor(dB) – Pre-Amplifier Factor(dB)
3. Margin value = Emission Level – Limit value
4. The other emission levels were very low against the limit.
5. " * " : Fundamental frequency.

RF Mode	TX BT_LE-1M	Channel	CH 39 : 2480 MHz
Frequency Range	1GHz ~ 25GHz	Detector Function	Peak (PK) Average (AV)

Antenna Polarity & Test Distance : Horizontal at 3 m

No	Frequency (MHz)	Emission Level (dBuV/m)	Limit (dBuV/m)	Margin (dB)	Antenna Height (m)	Table Angle (Degree)	Raw Value (dBuV)	Correction Factor (dB/m)
1	*2480.00	100.0 PK			1.08 H	332	102.8	-2.8
2	*2480.00	98.8 AV			1.08 H	332	101.6	-2.8
3	2483.70	55.2 PK	74.0	-18.8	1.08 H	332	58.0	-2.8
4	2483.70	44.7 AV	54.0	-9.3	1.08 H	332	47.5	-2.8
5	4960.00	41.6 PK	74.0	-32.4	1.43 H	140	39.6	2.0
6	4960.00	31.9 AV	54.0	-22.1	1.43 H	140	29.9	2.0
7	7440.00	51.6 PK	74.0	-22.4	1.49 H	7	44.0	7.6
8	7440.00	42.6 AV	54.0	-11.4	1.49 H	7	35.0	7.6

Antenna Polarity & Test Distance : Vertical at 3 m

No	Frequency (MHz)	Emission Level (dBuV/m)	Limit (dBuV/m)	Margin (dB)	Antenna Height (m)	Table Angle (Degree)	Raw Value (dBuV)	Correction Factor (dB/m)
1	*2480.00	97.3 PK			2.15 V	77	100.1	-2.8
2	*2480.00	96.2 AV			2.15 V	77	99.0	-2.8
3	2491.50	55.7 PK	74.0	-18.3	2.15 V	77	58.5	-2.8
4	2491.50	44.4 AV	54.0	-9.6	2.15 V	77	47.2	-2.8
5	4960.00	39.9 PK	74.0	-34.1	1.13 V	94	37.9	2.0
6	4960.00	29.8 AV	54.0	-24.2	1.13 V	94	27.8	2.0
7	7440.00	46.1 PK	74.0	-27.9	3.81 V	358	38.5	7.6
8	7440.00	37.4 AV	54.0	-16.6	3.81 V	358	29.8	7.6

Remarks:

1. Emission Level(dBuV/m) = Raw Value(dBuV) + Correction Factor(dB/m)
2. Correction Factor(dB/m) = Antenna Factor(dB/m) + Cable Factor(dB) – Pre-Amplifier Factor(dB)
3. Margin value = Emission Level – Limit value
4. The other emission levels were very low against the limit.
5. " * ": Fundamental frequency.

BT-LE 2M

RF Mode	TX BT_LE-2M	Channel	CH 1 : 2404 MHz
Frequency Range	1GHz ~ 25GHz	Detector Function	Peak (PK) Average (AV)

Antenna Polarity & Test Distance : Horizontal at 3 m

No	Frequency (MHz)	Emission Level (dBuV/m)	Limit (dBuV/m)	Margin (dB)	Antenna Height (m)	Table Angle (Degree)	Raw Value (dBuV)	Correction Factor (dB/m)
1	2386.11	54.9 PK	74.0	-19.1	1.15 H	313	57.6	-2.7
2	2386.11	43.3 AV	54.0	-10.7	1.15 H	313	46.0	-2.7
3	*2404.00	100.4 PK			1.15 H	313	103.1	-2.7
4	*2404.00	97.2 AV			1.15 H	313	99.9	-2.7
5	4808.00	41.6 PK	74.0	-32.4	1.38 H	140	39.8	1.8
6	4808.00	32.1 AV	54.0	-21.9	1.38 H	140	30.3	1.8

Antenna Polarity & Test Distance : Vertical at 3 m

No	Frequency (MHz)	Emission Level (dBuV/m)	Limit (dBuV/m)	Margin (dB)	Antenna Height (m)	Table Angle (Degree)	Raw Value (dBuV)	Correction Factor (dB/m)
1	2377.82	56.1 PK	74.0	-17.9	2.26 V	95	58.7	-2.6
2	2377.82	43.6 AV	54.0	-10.4	2.26 V	95	46.2	-2.6
3	*2404.00	97.9 PK			2.26 V	95	100.6	-2.7
4	*2404.00	94.8 AV			2.26 V	95	97.5	-2.7
5	4808.00	39.9 PK	74.0	-34.1	1.10 V	102	38.1	1.8
6	4808.00	29.8 AV	54.0	-24.2	1.10 V	102	28.0	1.8

Remarks:

1. Emission Level(dBuV/m) = Raw Value(dBuV) + Correction Factor(dB/m)
2. Correction Factor(dB/m) = Antenna Factor(dB/m) + Cable Factor(dB) – Pre-Amplifier Factor(dB)
3. Margin value = Emission Level – Limit value
4. The other emission levels were very low against the limit.
5. " * " : Fundamental frequency.

RF Mode	TX BT_LE-2M	Channel	CH 19 : 2440 MHz
Frequency Range	1GHz ~ 25GHz	Detector Function	Peak (PK) Average (AV)

Antenna Polarity & Test Distance : Horizontal at 3 m

No	Frequency (MHz)	Emission Level (dBuV/m)	Limit (dBuV/m)	Margin (dB)	Antenna Height (m)	Table Angle (Degree)	Raw Value (dBuV)	Correction Factor (dB/m)
1	*2440.00	99.8 PK			1.10 H	323	102.5	-2.7
2	*2440.00	96.8 AV			1.10 H	323	99.5	-2.7
3	4880.00	41.9 PK	74.0	-32.1	1.38 H	131	40.2	1.7
4	4880.00	32.0 AV	54.0	-22.0	1.38 H	131	30.3	1.7
5	7320.00	52.1 PK	74.0	-21.9	1.43 H	15	44.8	7.3
6	7320.00	42.9 AV	54.0	-11.1	1.43 H	15	35.6	7.3

Antenna Polarity & Test Distance : Vertical at 3 m

No	Frequency (MHz)	Emission Level (dBuV/m)	Limit (dBuV/m)	Margin (dB)	Antenna Height (m)	Table Angle (Degree)	Raw Value (dBuV)	Correction Factor (dB/m)
1	*2440.00	97.7 PK			2.20 V	96	100.4	-2.7
2	*2440.00	94.8 AV			2.20 V	96	97.5	-2.7
3	4880.00	39.8 PK	74.0	-34.2	1.14 V	102	38.1	1.7
4	4880.00	29.8 AV	54.0	-24.2	1.14 V	102	28.1	1.7
5	7320.00	46.4 PK	74.0	-27.6	3.91 V	351	39.1	7.3
6	7320.00	38.1 AV	54.0	-15.9	3.91 V	351	30.8	7.3

Remarks:

1. Emission Level(dBuV/m) = Raw Value(dBuV) + Correction Factor(dB/m)
2. Correction Factor(dB/m) = Antenna Factor(dB/m) + Cable Factor(dB) – Pre-Amplifier Factor(dB)
3. Margin value = Emission Level – Limit value
4. The other emission levels were very low against the limit.
5. " * ": Fundamental frequency.

RF Mode	TX BT_LE-2M	Channel	CH 38 : 2478 MHz
Frequency Range	1GHz ~ 25GHz	Detector Function	Peak (PK) Average (AV)

Antenna Polarity & Test Distance : Horizontal at 3 m

No	Frequency (MHz)	Emission Level (dBuV/m)	Limit (dBuV/m)	Margin (dB)	Antenna Height (m)	Table Angle (Degree)	Raw Value (dBuV)	Correction Factor (dB/m)
1	*2478.00	99.9 PK			1.06 H	336	102.7	-2.8
2	*2478.00	96.6 AV			1.06 H	336	99.4	-2.8
3	2486.95	55.4 PK	74.0	-18.6	1.06 H	336	58.2	-2.8
4	2486.95	43.5 AV	54.0	-10.5	1.06 H	336	46.3	-2.8
5	4956.00	41.4 PK	74.0	-32.6	1.38 H	132	39.5	1.9
6	4956.00	31.8 AV	54.0	-22.2	1.38 H	132	29.9	1.9
7	7434.00	51.1 PK	74.0	-22.9	1.48 H	18	43.6	7.5
8	7434.00	42.1 AV	54.0	-11.9	1.48 H	18	34.6	7.5

Antenna Polarity & Test Distance : Vertical at 3 m

No	Frequency (MHz)	Emission Level (dBuV/m)	Limit (dBuV/m)	Margin (dB)	Antenna Height (m)	Table Angle (Degree)	Raw Value (dBuV)	Correction Factor (dB/m)
1	*2478.00	96.9 PK			2.23 V	79	99.7	-2.8
2	*2478.00	94.1 AV			2.23 V	79	96.9	-2.8
3	2492.40	55.6 PK	74.0	-18.4	2.23 V	79	58.4	-2.8
4	2492.40	43.5 AV	54.0	-10.5	2.23 V	79	46.3	-2.8
5	4956.00	39.8 PK	74.0	-34.2	1.04 V	116	37.9	1.9
6	4956.00	29.6 AV	54.0	-24.4	1.04 V	116	27.7	1.9
7	7434.00	46.1 PK	74.0	-27.9	3.84 V	360	38.6	7.5
8	7434.00	37.5 AV	54.0	-16.5	3.84 V	360	30.0	7.5

Remarks:

1. Emission Level(dBuV/m) = Raw Value(dBuV) + Correction Factor(dB/m)
2. Correction Factor(dB/m) = Antenna Factor(dB/m) + Cable Factor(dB) – Pre-Amplifier Factor(dB)
3. Margin value = Emission Level – Limit value
4. The other emission levels were very low against the limit.
5. " * ": Fundamental frequency.

Below 1GHz Data:

BT-LE 2M

RF Mode	TX BT_GFSK	Channel	CH 1 : 2404 MHz
Frequency Range	9kHz ~ 1GHz	Detector Function	Quasi-Peak (QP)

Antenna Polarity & Test Distance : Horizontal at 3 m								
No	Frequency (MHz)	Emission Level (dBuV/m)	Limit (dBuV/m)	Margin (dB)	Antenna Height (m)	Table Angle (Degree)	Raw Value (dBuV)	Correction Factor (dB/m)
1	120.36	38.3 QP	43.5	-5.2	3.00 H	337	53.3	-15.0
2	166.48	35.0 QP	43.5	-8.5	2.00 H	145	48.1	-13.1
3	227.25	34.1 QP	46.0	-11.9	2.00 H	127	49.9	-15.8
4	298.46	34.6 QP	46.0	-11.4	1.50 H	81	47.0	-12.4
5	337.18	33.9 QP	46.0	-12.1	1.50 H	328	45.2	-11.3
6	574.71	26.4 QP	46.0	-19.6	1.50 H	107	32.6	-6.2

Remarks:

1. Emission Level(dBuV/m) = Raw Value(dBuV) + Correction Factor(dB/m)
2. Correction Factor(dB/m) = Antenna Factor(dB/m) + Cable Factor(dB) – Pre-Amplifier Factor(dB)
3. Margin value = Emission Level – Limit value
4. The other emission levels were very low against the limit of frequency range 30MHz~1000MHz.
5. The emission levels were very low against the limit of frequency range 9kHz~30MHz: the amplitude of spurious emissions attenuated more than 20 dB below the permissible value to be report.

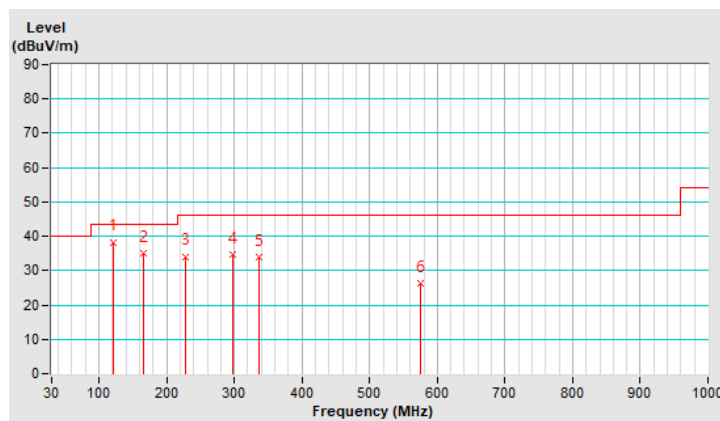

RF Mode	TX BT_GFSK	Channel	CH 1 : 2404 MHz
Frequency Range	9kHz ~ 1GHz	Detector Function	Quasi-Peak (QP)

Antenna Polarity & Test Distance : Vertical at 3 m								
No	Frequency (MHz)	Emission Level (dBuV/m)	Limit (dBuV/m)	Margin (dB)	Antenna Height (m)	Table Angle (Degree)	Raw Value (dBuV)	Correction Factor (dB/m)
1	125.82	29.0 QP	43.5	-14.5	1.00 V	33	43.4	-14.4
2	167.05	32.6 QP	43.5	-10.9	1.50 V	229	45.6	-13.0
3	223.10	31.0 QP	46.0	-15.0	1.00 V	150	47.0	-16.0
4	340.50	26.2 QP	46.0	-19.8	1.50 V	173	37.5	-11.3
5	499.09	25.0 QP	46.0	-21.0	1.50 V	45	32.6	-7.6
6	949.73	32.8 QP	46.0	-13.2	1.00 V	138	33.4	-0.6

Remarks:

1. Emission Level(dBuV/m) = Raw Value(dBuV) + Correction Factor(dB/m)
2. Correction Factor(dB/m) = Antenna Factor(dB/m) + Cable Factor(dB) – Pre-Amplifier Factor(dB)
3. Margin value = Emission Level – Limit value
4. The other emission levels were very low against the limit of frequency range 30MHz~1000MHz.
5. The emission levels were very low against the limit of frequency range 9kHz~30MHz: the amplitude of spurious emissions attenuated more than 20 dB below the permissible value to be report.

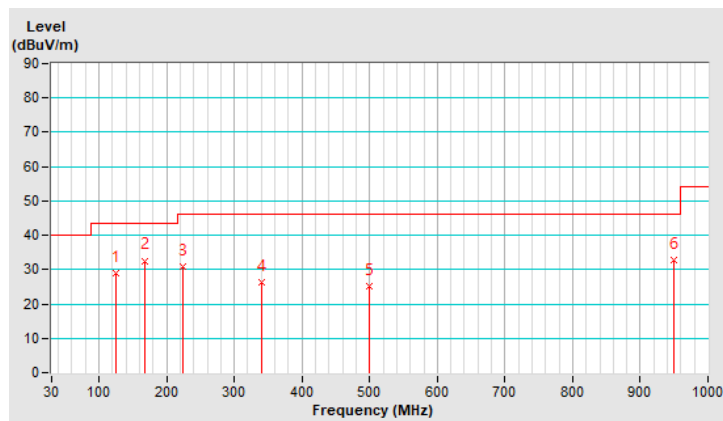

4.1.8 Test Results (Mode 2)

Dipole Antenna

Above 1GHz Data :

BT-LE 1M

RF Mode	TX BT_LE-1M	Channel	CH 0 : 2402 MHz
Frequency Range	1GHz ~ 25GHz	Detector Function	Peak (PK) Average (AV)

Antenna Polarity & Test Distance : Horizontal at 3 m

No	Frequency (MHz)	Emission Level (dBuV/m)	Limit (dBuV/m)	Margin (dB)	Antenna Height (m)	Table Angle (Degree)	Raw Value (dBuV)	Correction Factor (dB/m)
1	2385.83	55.4 PK	74.0	-18.6	1.06 H	143	58.1	-2.7
2	2385.83	44.4 AV	54.0	-9.6	1.06 H	143	47.1	-2.7
3	*2402.00	99.9 PK			1.06 H	143	102.6	-2.7
4	*2402.00	98.9 AV			1.06 H	143	101.6	-2.7
5	4804.00	37.8 PK	74.0	-36.2	1.52 H	143	36.0	1.8
6	4804.00	30.6 AV	54.0	-23.4	1.52 H	143	28.8	1.8

Antenna Polarity & Test Distance : Vertical at 3 m

No	Frequency (MHz)	Emission Level (dBuV/m)	Limit (dBuV/m)	Margin (dB)	Antenna Height (m)	Table Angle (Degree)	Raw Value (dBuV)	Correction Factor (dB/m)
1	2372.40	55.2 PK	74.0	-18.8	1.53 V	241	57.8	-2.6
2	2372.40	44.4 AV	54.0	-9.6	1.53 V	241	47.0	-2.6
3	*2402.00	109.2 PK			1.53 V	241	111.9	-2.7
4	*2402.00	108.2 AV			1.53 V	241	110.9	-2.7
5	4804.00	43.6 PK	74.0	-30.4	1.28 V	303	41.8	1.8
6	4804.00	36.5 AV	54.0	-17.5	1.28 V	303	34.7	1.8

Remarks:

1. Emission Level(dBuV/m) = Raw Value(dBuV) + Correction Factor(dB/m)
2. Correction Factor(dB/m) = Antenna Factor(dB/m) + Cable Factor(dB) – Pre-Amplifier Factor(dB)
3. Margin value = Emission Level – Limit value
4. The other emission levels were very low against the limit.
5. " * " : Fundamental frequency.

RF Mode	TX BT_LE-1M	Channel	CH 19 : 2440 MHz
Frequency Range	1GHz ~ 25GHz	Detector Function	Peak (PK) Average (AV)

Antenna Polarity & Test Distance : Horizontal at 3 m

No	Frequency (MHz)	Emission Level (dBuV/m)	Limit (dBuV/m)	Margin (dB)	Antenna Height (m)	Table Angle (Degree)	Raw Value (dBuV)	Correction Factor (dB/m)
1	*2440.00	99.5 PK			1.39 H	161	102.2	-2.7
2	*2440.00	98.0 AV			1.39 H	161	100.7	-2.7
3	4880.00	37.8 PK	74.0	-36.2	1.57 H	133	36.1	1.7
4	4880.00	30.5 AV	54.0	-23.5	1.57 H	133	28.8	1.7
5	7320.00	47.8 PK	74.0	-26.2	1.82 H	189	40.5	7.3
6	7320.00	37.7 AV	54.0	-16.3	1.82 H	189	30.4	7.3

Antenna Polarity & Test Distance : Vertical at 3 m

No	Frequency (MHz)	Emission Level (dBuV/m)	Limit (dBuV/m)	Margin (dB)	Antenna Height (m)	Table Angle (Degree)	Raw Value (dBuV)	Correction Factor (dB/m)
1	*2440.00	109.3 PK			1.51 V	233	112.0	-2.7
2	*2440.00	108.2 AV			1.51 V	233	110.9	-2.7
3	4880.00	43.3 PK	74.0	-30.7	1.32 V	307	41.6	1.7
4	4880.00	36.6 AV	54.0	-17.4	1.32 V	307	34.9	1.7
5	7320.00	51.6 PK	74.0	-22.4	1.64 V	257	44.3	7.3
6	7320.00	43.4 AV	54.0	-10.6	1.64 V	257	36.1	7.3

Remarks:

1. Emission Level(dBuV/m) = Raw Value(dBuV) + Correction Factor(dB/m)
2. Correction Factor(dB/m) = Antenna Factor(dB/m) + Cable Factor(dB) – Pre-Amplifier Factor(dB)
3. Margin value = Emission Level – Limit value
4. The other emission levels were very low against the limit.
5. " * " : Fundamental frequency.

RF Mode	TX BT_LE-1M	Channel	CH 39 : 2480 MHz
Frequency Range	1GHz ~ 25GHz	Detector Function	Peak (PK) Average (AV)

Antenna Polarity & Test Distance : Horizontal at 3 m

No	Frequency (MHz)	Emission Level (dBuV/m)	Limit (dBuV/m)	Margin (dB)	Antenna Height (m)	Table Angle (Degree)	Raw Value (dBuV)	Correction Factor (dB/m)
1	*2480.00	99.1 PK			1.40 H	149	101.9	-2.8
2	*2480.00	97.9 AV			1.40 H	149	100.7	-2.8
3	2484.60	55.4 PK	74.0	-18.6	1.40 H	149	58.2	-2.8
4	2484.60	44.4 AV	54.0	-9.6	1.40 H	149	47.2	-2.8
5	4960.00	37.8 PK	74.0	-36.2	1.58 H	141	35.8	2.0
6	4960.00	30.4 AV	54.0	-23.6	1.58 H	141	28.4	2.0
7	7440.00	47.6 PK	74.0	-26.4	1.76 H	211	40.0	7.6
8	7440.00	37.2 AV	54.0	-16.8	1.76 H	211	29.6	7.6

Antenna Polarity & Test Distance : Vertical at 3 m

No	Frequency (MHz)	Emission Level (dBuV/m)	Limit (dBuV/m)	Margin (dB)	Antenna Height (m)	Table Angle (Degree)	Raw Value (dBuV)	Correction Factor (dB/m)
1	*2480.00	110.3 PK			1.57 V	235	113.1	-2.8
2	*2480.00	109.1 AV			1.57 V	235	111.9	-2.8
3	2484.54	56.7 PK	74.0	-17.3	1.57 V	235	59.5	-2.8
4	2484.54	45.4 AV	54.0	-8.6	1.57 V	235	48.2	-2.8
5	4960.00	43.2 PK	74.0	-30.8	1.31 V	302	41.2	2.0
6	4960.00	36.1 AV	54.0	-17.9	1.31 V	302	34.1	2.0
7	7440.00	51.6 PK	74.0	-22.4	1.65 V	266	44.0	7.6
8	7440.00	43.4 AV	54.0	-10.6	1.65 V	266	35.8	7.6

Remarks:

1. Emission Level(dBuV/m) = Raw Value(dBuV) + Correction Factor(dB/m)
2. Correction Factor(dB/m) = Antenna Factor(dB/m) + Cable Factor(dB) – Pre-Amplifier Factor(dB)
3. Margin value = Emission Level – Limit value
4. The other emission levels were very low against the limit.
5. " * ": Fundamental frequency.

BT-LE 2M

RF Mode	TX BT_LE-2M	Channel	CH 1 : 2404 MHz
Frequency Range	1GHz ~ 25GHz	Detector Function	Peak (PK) Average (AV)

Antenna Polarity & Test Distance : Horizontal at 3 m

No	Frequency (MHz)	Emission Level (dBuV/m)	Limit (dBuV/m)	Margin (dB)	Antenna Height (m)	Table Angle (Degree)	Raw Value (dBuV)	Correction Factor (dB/m)
1	2390.00	56.3 PK	74.0	-17.7	1.02 H	140	59.0	-2.7
2	2390.00	43.7 AV	54.0	-10.3	1.02 H	140	46.4	-2.7
3	*2404.00	100.1 PK			1.02 H	140	102.8	-2.7
4	*2404.00	96.9 AV			1.02 H	140	99.6	-2.7
5	4808.00	37.7 PK	74.0	-36.3	1.54 H	150	35.9	1.8
6	4808.00	30.4 AV	54.0	-23.6	1.54 H	150	28.6	1.8

Antenna Polarity & Test Distance : Vertical at 3 m

No	Frequency (MHz)	Emission Level (dBuV/m)	Limit (dBuV/m)	Margin (dB)	Antenna Height (m)	Table Angle (Degree)	Raw Value (dBuV)	Correction Factor (dB/m)
1	2387.00	56.0 PK	74.0	-18.0	1.55 V	237	58.7	-2.7
2	2387.00	43.8 AV	54.0	-10.2	1.55 V	237	46.5	-2.7
3	*2404.00	109.3 PK			1.55 V	237	112.0	-2.7
4	*2404.00	106.4 AV			1.55 V	237	109.1	-2.7
5	4808.00	43.9 PK	74.0	-30.1	1.23 V	290	42.1	1.8
6	4808.00	36.8 AV	54.0	-17.2	1.23 V	290	35.0	1.8

Remarks:

1. Emission Level(dBuV/m) = Raw Value(dBuV) + Correction Factor(dB/m)
2. Correction Factor(dB/m) = Antenna Factor(dB/m) + Cable Factor(dB) – Pre-Amplifier Factor(dB)
3. Margin value = Emission Level – Limit value
4. The other emission levels were very low against the limit.
5. " * ": Fundamental frequency.

RF Mode	TX BT_LE-2M	Channel	CH 19 : 2440 MHz
Frequency Range	1GHz ~ 25GHz	Detector Function	Peak (PK) Average (AV)

Antenna Polarity & Test Distance : Horizontal at 3 m

No	Frequency (MHz)	Emission Level (dBuV/m)	Limit (dBuV/m)	Margin (dB)	Antenna Height (m)	Table Angle (Degree)	Raw Value (dBuV)	Correction Factor (dB/m)
1	*2440.00	99.1 PK			1.45 H	148	101.8	-2.7
2	*2440.00	95.9 AV			1.45 H	148	98.6	-2.7
3	4880.00	38.0 PK	74.0	-36.0	1.58 H	151	36.3	1.7
4	4880.00	30.7 AV	54.0	-23.3	1.58 H	151	29.0	1.7
5	7320.00	47.6 PK	74.0	-26.4	1.71 H	212	40.3	7.3
6	7320.00	37.4 AV	54.0	-16.6	1.71 H	212	30.1	7.3

Antenna Polarity & Test Distance : Vertical at 3 m

No	Frequency (MHz)	Emission Level (dBuV/m)	Limit (dBuV/m)	Margin (dB)	Antenna Height (m)	Table Angle (Degree)	Raw Value (dBuV)	Correction Factor (dB/m)
1	*2440.00	109.8 PK			1.60 V	226	112.5	-2.7
2	*2440.00	106.7 AV			1.60 V	226	109.4	-2.7
3	4880.00	43.3 PK	74.0	-30.7	1.25 V	301	41.6	1.7
4	4880.00	36.0 AV	54.0	-18.0	1.25 V	301	34.3	1.7
5	7320.00	51.1 PK	74.0	-22.9	1.54 V	279	43.8	7.3
6	7320.00	43.3 AV	54.0	-10.7	1.54 V	279	36.0	7.3

Remarks:

1. Emission Level(dBuV/m) = Raw Value(dBuV) + Correction Factor(dB/m)
2. Correction Factor(dB/m) = Antenna Factor(dB/m) + Cable Factor(dB) – Pre-Amplifier Factor(dB)
3. Margin value = Emission Level – Limit value
4. The other emission levels were very low against the limit.
5. " * " : Fundamental frequency.

RF Mode	TX BT_LE-2M	Channel	CH 38 : 2478 MHz
Frequency Range	1GHz ~ 25GHz	Detector Function	Peak (PK) Average (AV)

Antenna Polarity & Test Distance : Horizontal at 3 m

No	Frequency (MHz)	Emission Level (dBuV/m)	Limit (dBuV/m)	Margin (dB)	Antenna Height (m)	Table Angle (Degree)	Raw Value (dBuV)	Correction Factor (dB/m)
1	*2478.00	99.3 PK			1.48 H	152	102.1	-2.8
2	*2478.00	95.9 AV			1.48 H	152	98.7	-2.8
3	2486.44	57.1 PK	74.0	-16.9	1.48 H	152	59.9	-2.8
4	2486.44	43.5 AV	54.0	-10.5	1.48 H	152	46.3	-2.8
5	4956.00	38.1 PK	74.0	-35.9	1.52 H	158	36.2	1.9
6	4956.00	30.8 AV	54.0	-23.2	1.52 H	158	28.9	1.9
7	7434.00	47.8 PK	74.0	-26.2	1.73 H	186	40.3	7.5
8	7434.00	37.7 AV	54.0	-16.3	1.73 H	186	30.2	7.5

Antenna Polarity & Test Distance : Vertical at 3 m

No	Frequency (MHz)	Emission Level (dBuV/m)	Limit (dBuV/m)	Margin (dB)	Antenna Height (m)	Table Angle (Degree)	Raw Value (dBuV)	Correction Factor (dB/m)
1	*2478.00	110.0 PK			1.53 V	231	112.8	-2.8
2	*2478.00	107.1 AV			1.53 V	231	109.9	-2.8
3	2483.50	57.3 PK	74.0	-16.7	1.53 V	231	60.1	-2.8
4	2483.50	46.3 AV	54.0	-7.7	1.53 V	231	49.1	-2.8
5	4956.00	43.7 PK	74.0	-30.3	1.28 V	296	41.8	1.9
6	4956.00	36.7 AV	54.0	-17.3	1.28 V	296	34.8	1.9
7	7434.00	51.7 PK	74.0	-22.3	1.57 V	278	44.2	7.5
8	7434.00	43.9 AV	54.0	-10.1	1.57 V	278	36.4	7.5

Remarks:

1. Emission Level(dBuV/m) = Raw Value(dBuV) + Correction Factor(dB/m)
2. Correction Factor(dB/m) = Antenna Factor(dB/m) + Cable Factor(dB) – Pre-Amplifier Factor(dB)
3. Margin value = Emission Level – Limit value
4. The other emission levels were very low against the limit.
5. " * ": Fundamental frequency.

Below 1GHz Data:

BT-LE 2M

RF Mode	TX BT_GFSK	Channel	CH 1 : 2404 MHz
Frequency Range	9kHz ~ 1GHz	Detector Function	Quasi-Peak (QP)

Antenna Polarity & Test Distance : Horizontal at 3 m								
No	Frequency (MHz)	Emission Level (dBuV/m)	Limit (dBuV/m)	Margin (dB)	Antenna Height (m)	Table Angle (Degree)	Raw Value (dBuV)	Correction Factor (dB/m)
1	119.47	37.9 QP	43.5	-5.6	3.00 H	349	53.0	-15.1
2	167.37	35.4 QP	43.5	-8.1	2.00 H	145	48.5	-13.1
3	226.58	33.2 QP	46.0	-12.8	2.00 H	137	49.1	-15.9
4	298.82	34.9 QP	46.0	-11.1	1.50 H	81	47.2	-12.3
5	336.99	33.9 QP	46.0	-12.1	1.50 H	327	45.2	-11.3
6	575.22	27.0 QP	46.0	-19.0	1.50 H	129	33.2	-6.2

Remarks:

1. Emission Level(dBuV/m) = Raw Value(dBuV) + Correction Factor(dB/m)
2. Correction Factor(dB/m) = Antenna Factor(dB/m) + Cable Factor(dB) – Pre-Amplifier Factor(dB)
3. Margin value = Emission Level – Limit value
4. The other emission levels were very low against the limit of frequency range 30MHz~1000MHz.
5. The emission levels were very low against the limit of frequency range 9kHz~30MHz: the amplitude of spurious emissions attenuated more than 20 dB below the permissible value to be report.

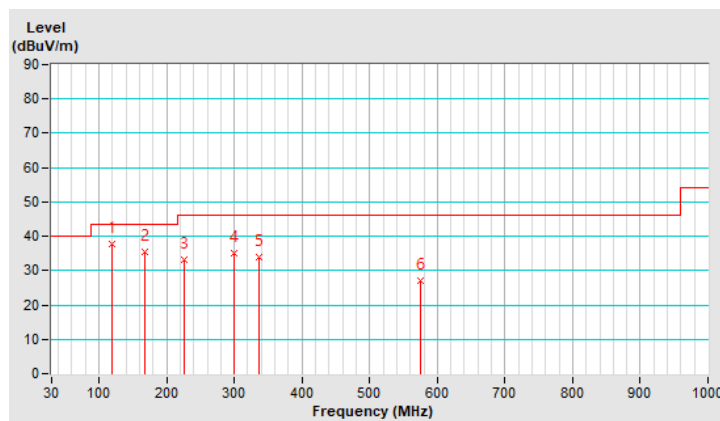

RF Mode	TX BT_GFSK	Channel	CH 1 : 2404 MHz
Frequency Range	9kHz ~ 1GHz	Detector Function	Quasi-Peak (QP)

Antenna Polarity & Test Distance : Vertical at 3 m								
No	Frequency (MHz)	Emission Level (dBuV/m)	Limit (dBuV/m)	Margin (dB)	Antenna Height (m)	Table Angle (Degree)	Raw Value (dBuV)	Correction Factor (dB/m)
1	124.92	28.6 QP	43.5	-14.9	1.00 V	22	43.2	-14.6
2	167.16	32.3 QP	43.5	-11.2	1.50 V	228	45.4	-13.1
3	223.63	31.2 QP	46.0	-14.8	1.00 V	124	47.2	-16.0
4	340.81	26.6 QP	46.0	-19.4	1.50 V	168	37.9	-11.3
5	498.78	24.6 QP	46.0	-21.4	1.50 V	45	32.2	-7.6
6	949.51	32.2 QP	46.0	-13.8	1.00 V	147	32.8	-0.6

Remarks:

1. Emission Level(dBuV/m) = Raw Value(dBuV) + Correction Factor(dB/m)
2. Correction Factor(dB/m) = Antenna Factor(dB/m) + Cable Factor(dB) – Pre-Amplifier Factor(dB)
3. Margin value = Emission Level – Limit value
4. The other emission levels were very low against the limit of frequency range 30MHz~1000MHz.
5. The emission levels were very low against the limit of frequency range 9kHz~30MHz: the amplitude of spurious emissions attenuated more than 20 dB below the permissible value to be report.

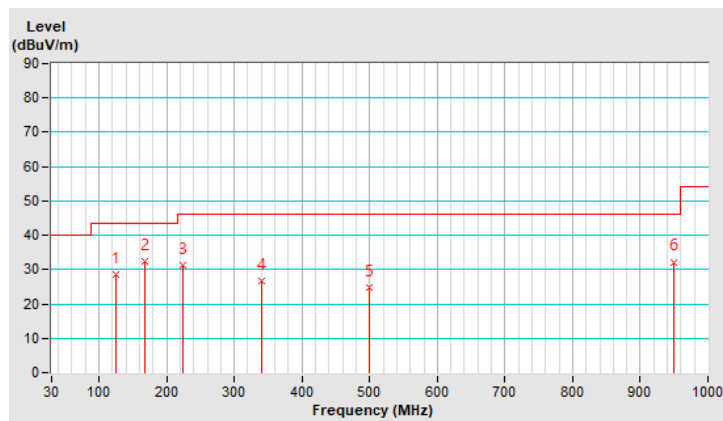

PIFA Antenna

Above 1GHz Data:

BT-LE 1M

RF Mode	TX BT_LE-1M	Channel	CH 0 : 2402 MHz
Frequency Range	1GHz ~ 25GHz	Detector Function	Peak (PK) Average (AV)

Antenna Polarity & Test Distance : Horizontal at 3 m								
No	Frequency (MHz)	Emission Level (dBuV/m)	Limit (dBuV/m)	Margin (dB)	Antenna Height (m)	Table Angle (Degree)	Raw Value (dBuV)	Correction Factor (dB/m)
1	2364.20	54.9 PK	74.0	-19.1	1.04 H	322	57.6	-2.7
2	2364.20	43.5 AV	54.0	-10.5	1.04 H	322	46.2	-2.7
3	*2402.00	105.2 PK			1.04 H	322	107.9	-2.7
4	*2402.00	104.2 AV			1.04 H	322	106.9	-2.7
5	4804.00	40.8 PK	74.0	-33.2	1.31 H	143	39.0	1.8
6	4804.00	31.1 AV	54.0	-22.9	1.31 H	143	29.3	1.8
Antenna Polarity & Test Distance : Vertical at 3 m								
No	Frequency (MHz)	Emission Level (dBuV/m)	Limit (dBuV/m)	Margin (dB)	Antenna Height (m)	Table Angle (Degree)	Raw Value (dBuV)	Correction Factor (dB/m)
1	2359.00	56.2 PK	74.0	-17.8	2.17 V	82	58.9	-2.7
2	2359.00	44.3 AV	54.0	-9.7	2.17 V	82	47.0	-2.7
3	*2402.00	104.3 PK			2.17 V	82	107.0	-2.7
4	*2402.00	103.2 AV			2.17 V	82	105.9	-2.7
5	4804.00	39.9 PK	74.0	-34.1	1.04 V	107	38.1	1.8
6	4804.00	30.3 AV	54.0	-23.7	1.04 V	107	28.5	1.8

Remarks:

1. Emission Level(dBuV/m) = Raw Value(dBuV) + Correction Factor(dB/m)
2. Correction Factor(dB/m) = Antenna Factor(dB/m) + Cable Factor(dB) – Pre-Amplifier Factor(dB)
3. Margin value = Emission Level – Limit value
4. The other emission levels were very low against the limit.
5. " * ": Fundamental frequency.

RF Mode	TX BT_LE-1M	Channel	CH 19 : 2440 MHz
Frequency Range	1GHz ~ 25GHz	Detector Function	Peak (PK) Average (AV)

Antenna Polarity & Test Distance : Horizontal at 3 m

No	Frequency (MHz)	Emission Level (dBuV/m)	Limit (dBuV/m)	Margin (dB)	Antenna Height (m)	Table Angle (Degree)	Raw Value (dBuV)	Correction Factor (dB/m)
1	*2440.00	105.3 PK			1.03 H	319	108.0	-2.7
2	*2440.00	104.2 AV			1.03 H	319	106.9	-2.7
3	4880.00	40.9 PK	74.0	-33.1	1.32 H	142	39.2	1.7
4	4880.00	31.2 AV	54.0	-22.8	1.32 H	142	29.5	1.7
5	7320.00	52.7 PK	74.0	-21.3	1.48 H	14	45.4	7.3
6	7320.00	43.6 AV	54.0	-10.4	1.48 H	14	36.3	7.3

Antenna Polarity & Test Distance : Vertical at 3 m

No	Frequency (MHz)	Emission Level (dBuV/m)	Limit (dBuV/m)	Margin (dB)	Antenna Height (m)	Table Angle (Degree)	Raw Value (dBuV)	Correction Factor (dB/m)
1	*2440.00	104.7 PK			2.21 V	91	107.4	-2.7
2	*2440.00	103.5 AV			2.21 V	91	106.2	-2.7
3	4880.00	40.4 PK	74.0	-33.6	1.04 V	96	38.7	1.7
4	4880.00	30.9 AV	54.0	-23.1	1.04 V	96	29.2	1.7
5	7320.00	48.4 PK	74.0	-25.6	3.84 V	348	41.1	7.3
6	7320.00	40.0 AV	54.0	-14.0	3.84 V	348	32.7	7.3

Remarks:

1. Emission Level(dBuV/m) = Raw Value(dBuV) + Correction Factor(dB/m)
2. Correction Factor(dB/m) = Antenna Factor(dB/m) + Cable Factor(dB) – Pre-Amplifier Factor(dB)
3. Margin value = Emission Level – Limit value
4. The other emission levels were very low against the limit.
5. " * ": Fundamental frequency.

RF Mode	TX BT_LE-1M	Channel	CH 39 : 2480 MHz
Frequency Range	1GHz ~ 25GHz	Detector Function	Peak (PK) Average (AV)

Antenna Polarity & Test Distance : Horizontal at 3 m

No	Frequency (MHz)	Emission Level (dBuV/m)	Limit (dBuV/m)	Margin (dB)	Antenna Height (m)	Table Angle (Degree)	Raw Value (dBuV)	Correction Factor (dB/m)
1	*2480.00	105.8 PK			1.02 H	330	108.6	-2.8
2	*2480.00	104.6 AV			1.02 H	330	107.4	-2.8
3	2487.00	55.5 PK	74.0	-18.5	1.02 H	330	58.3	-2.8
4	2487.00	44.3 AV	54.0	-9.7	1.02 H	330	47.1	-2.8
5	4960.00	40.8 PK	74.0	-33.2	1.29 H	139	38.8	2.0
6	4960.00	31.0 AV	54.0	-23.0	1.29 H	139	29.0	2.0
7	7440.00	53.1 PK	74.0	-20.9	1.45 H	23	45.5	7.6
8	7440.00	43.7 AV	54.0	-10.3	1.45 H	23	36.1	7.6

Antenna Polarity & Test Distance : Vertical at 3 m

No	Frequency (MHz)	Emission Level (dBuV/m)	Limit (dBuV/m)	Margin (dB)	Antenna Height (m)	Table Angle (Degree)	Raw Value (dBuV)	Correction Factor (dB/m)
1	*2480.00	103.8 PK			2.19 V	83	106.6	-2.8
2	*2480.00	102.6 AV			2.19 V	83	105.4	-2.8
3	2483.50	55.4 PK	74.0	-18.6	2.19 V	83	58.2	-2.8
4	2483.50	44.5 AV	54.0	-9.5	2.19 V	83	47.3	-2.8
5	4960.00	40.3 PK	74.0	-33.7	1.13 V	93	38.3	2.0
6	4960.00	30.8 AV	54.0	-23.2	1.13 V	93	28.8	2.0
7	7440.00	48.5 PK	74.0	-25.5	3.91 V	346	40.9	7.6
8	7440.00	39.7 AV	54.0	-14.3	3.91 V	346	32.1	7.6

Remarks:

1. Emission Level(dBuV/m) = Raw Value(dBuV) + Correction Factor(dB/m)
2. Correction Factor(dB/m) = Antenna Factor(dB/m) + Cable Factor(dB) – Pre-Amplifier Factor(dB)
3. Margin value = Emission Level – Limit value
4. The other emission levels were very low against the limit.
5. " * ": Fundamental frequency.

BT-LE 2M

RF Mode	TX BT_LE-2M	Channel	CH 1 : 2404 MHz
Frequency Range	1GHz ~ 25GHz	Detector Function	Peak (PK) Average (AV)

Antenna Polarity & Test Distance : Horizontal at 3 m

No	Frequency (MHz)	Emission Level (dBuV/m)	Limit (dBuV/m)	Margin (dB)	Antenna Height (m)	Table Angle (Degree)	Raw Value (dBuV)	Correction Factor (dB/m)
1	2382.20	56.3 PK	74.0	-17.7	1.10 H	330	58.9	-2.6
2	2382.20	43.5 AV	54.0	-10.5	1.10 H	330	46.1	-2.6
3	*2404.00	106.1 PK			1.10 H	330	108.8	-2.7
4	*2404.00	102.9 AV			1.10 H	330	105.6	-2.7
5	4808.00	40.8 PK	74.0	-33.2	1.33 H	164	39.0	1.8
6	4808.00	30.8 AV	54.0	-23.2	1.33 H	164	29.0	1.8

Antenna Polarity & Test Distance : Vertical at 3 m

No	Frequency (MHz)	Emission Level (dBuV/m)	Limit (dBuV/m)	Margin (dB)	Antenna Height (m)	Table Angle (Degree)	Raw Value (dBuV)	Correction Factor (dB/m)
1	2356.10	55.5 PK	74.0	-18.5	2.11 V	79	58.2	-2.7
2	2356.10	43.5 AV	54.0	-10.5	2.11 V	79	46.2	-2.7
3	*2404.00	104.3 PK			2.11 V	79	107.0	-2.7
4	*2404.00	101.3 AV			2.11 V	79	104.0	-2.7
5	4808.00	41.1 PK	74.0	-32.9	1.06 V	104	39.3	1.8
6	4808.00	31.1 AV	54.0	-22.9	1.06 V	104	29.3	1.8

Remarks:

1. Emission Level(dBuV/m) = Raw Value(dBuV) + Correction Factor(dB/m)
2. Correction Factor(dB/m) = Antenna Factor(dB/m) + Cable Factor(dB) – Pre-Amplifier Factor(dB)
3. Margin value = Emission Level – Limit value
4. The other emission levels were very low against the limit.
5. " * ": Fundamental frequency.

RF Mode	TX BT_LE-2M	Channel	CH 19 : 2440 MHz
Frequency Range	1GHz ~ 25GHz	Detector Function	Peak (PK) Average (AV)

Antenna Polarity & Test Distance : Horizontal at 3 m

No	Frequency (MHz)	Emission Level (dBuV/m)	Limit (dBuV/m)	Margin (dB)	Antenna Height (m)	Table Angle (Degree)	Raw Value (dBuV)	Correction Factor (dB/m)
1	*2440.00	106.9 PK			1.10 H	338	109.6	-2.7
2	*2440.00	103.4 AV			1.10 H	338	106.1	-2.7
3	4880.00	41.0 PK	74.0	-33.0	1.38 H	160	39.3	1.7
4	4880.00	30.9 AV	54.0	-23.1	1.38 H	160	29.2	1.7
5	7320.00	52.8 PK	74.0	-21.2	1.44 H	6	45.5	7.3
6	7320.00	43.6 AV	54.0	-10.4	1.44 H	6	36.3	7.3

Antenna Polarity & Test Distance : Vertical at 3 m

No	Frequency (MHz)	Emission Level (dBuV/m)	Limit (dBuV/m)	Margin (dB)	Antenna Height (m)	Table Angle (Degree)	Raw Value (dBuV)	Correction Factor (dB/m)
1	*2440.00	104.2 PK			2.15 V	73	106.9	-2.7
2	*2440.00	101.1 AV			2.15 V	73	103.8	-2.7
3	4880.00	39.6 PK	74.0	-34.4	1.12 V	86	37.9	1.7
4	4880.00	30.2 AV	54.0	-23.8	1.12 V	86	28.5	1.7
5	7320.00	48.3 PK	74.0	-25.7	3.92 V	344	41.0	7.3
6	7320.00	39.7 AV	54.0	-14.3	3.92 V	344	32.4	7.3

Remarks:

1. Emission Level(dBuV/m) = Raw Value(dBuV) + Correction Factor(dB/m)
2. Correction Factor(dB/m) = Antenna Factor(dB/m) + Cable Factor(dB) – Pre-Amplifier Factor(dB)
3. Margin value = Emission Level – Limit value
4. The other emission levels were very low against the limit.
5. " * ": Fundamental frequency.

RF Mode	TX BT_LE-2M	Channel	CH 38 : 2478 MHz
Frequency Range	1GHz ~ 25GHz	Detector Function	Peak (PK) Average (AV)

Antenna Polarity & Test Distance : Horizontal at 3 m

No	Frequency (MHz)	Emission Level (dBuV/m)	Limit (dBuV/m)	Margin (dB)	Antenna Height (m)	Table Angle (Degree)	Raw Value (dBuV)	Correction Factor (dB/m)
1	*2478.00	106.4 PK			1.12 H	326	109.2	-2.8
2	*2478.00	103.1 AV			1.12 H	326	105.9	-2.8
3	2483.50	55.4 PK	74.0	-18.6	1.12 H	326	58.2	-2.8
4	2483.50	43.7 AV	54.0	-10.3	1.12 H	326	46.5	-2.8
5	4956.00	40.9 PK	74.0	-33.1	1.41 H	156	39.0	1.9
6	4956.00	31.0 AV	54.0	-23.0	1.41 H	156	29.1	1.9
7	7434.00	52.9 PK	74.0	-21.1	1.42 H	31	45.4	7.5
8	7434.00	43.7 AV	54.0	-10.3	1.42 H	31	36.2	7.5

Antenna Polarity & Test Distance : Vertical at 3 m

No	Frequency (MHz)	Emission Level (dBuV/m)	Limit (dBuV/m)	Margin (dB)	Antenna Height (m)	Table Angle (Degree)	Raw Value (dBuV)	Correction Factor (dB/m)
1	*2478.00	104.1 PK			2.20 V	88	106.9	-2.8
2	*2478.00	100.9 AV			2.20 V	88	103.7	-2.8
3	2491.20	55.6 PK	74.0	-18.4	2.20 V	88	58.4	-2.8
4	2491.20	43.6 AV	54.0	-10.4	2.20 V	88	46.4	-2.8
5	4956.00	40.3 PK	74.0	-33.7	1.10 V	113	38.4	1.9
6	4956.00	30.9 AV	54.0	-23.1	1.10 V	113	29.0	1.9
7	7434.00	48.6 PK	74.0	-25.4	3.89 V	346	41.1	7.5
8	7434.00	39.9 AV	54.0	-14.1	3.89 V	346	32.4	7.5

Remarks:

1. Emission Level(dBuV/m) = Raw Value(dBuV) + Correction Factor(dB/m)
2. Correction Factor(dB/m) = Antenna Factor(dB/m) + Cable Factor(dB) – Pre-Amplifier Factor(dB)
3. Margin value = Emission Level – Limit value
4. The other emission levels were very low against the limit.
5. " * ": Fundamental frequency.

Below 1GHz Data:

BT-LE 2M

RF Mode	TX BT_GFSK	Channel	CH 1 : 2404 MHz
Frequency Range	9kHz ~ 1GHz	Detector Function	Quasi-Peak (QP)

Antenna Polarity & Test Distance : Horizontal at 3 m								
No	Frequency (MHz)	Emission Level (dBuV/m)	Limit (dBuV/m)	Margin (dB)	Antenna Height (m)	Table Angle (Degree)	Raw Value (dBuV)	Correction Factor (dB/m)
1	120.08	38.3 QP	43.5	-5.2	3.00 H	341	53.3	-15.0
2	167.26	35.4 QP	43.5	-8.1	2.00 H	137	48.5	-13.1
3	226.35	33.4 QP	46.0	-12.6	2.00 H	135	49.3	-15.9
4	298.88	34.5 QP	46.0	-11.5	1.50 H	93	46.8	-12.3
5	335.94	33.3 QP	46.0	-12.7	1.50 H	345	44.6	-11.3
6	574.41	26.1 QP	46.0	-19.9	1.50 H	118	32.3	-6.2

Remarks:

1. Emission Level(dBuV/m) = Raw Value(dBuV) + Correction Factor(dB/m)
2. Correction Factor(dB/m) = Antenna Factor(dB/m) + Cable Factor(dB) – Pre-Amplifier Factor(dB)
3. Margin value = Emission Level – Limit value
4. The other emission levels were very low against the limit of frequency range 30MHz~1000MHz.
5. The emission levels were very low against the limit of frequency range 9kHz~30MHz: the amplitude of spurious emissions attenuated more than 20 dB below the permissible value to be report.

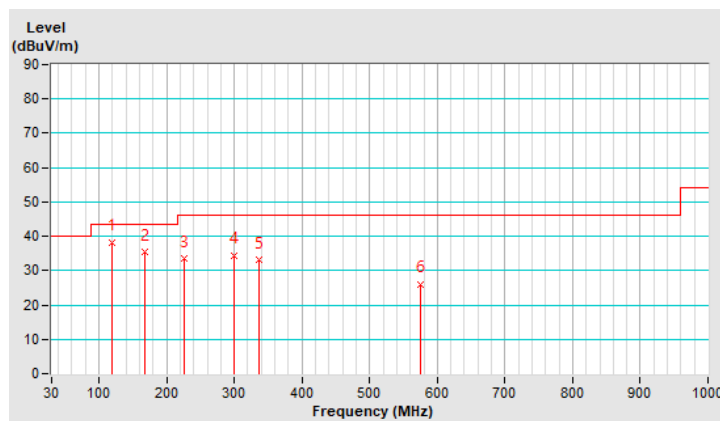

RF Mode	TX BT_GFSK	Channel	CH 1 : 2404 MHz
Frequency Range	9kHz ~ 1GHz	Detector Function	Quasi-Peak (QP)

Antenna Polarity & Test Distance : Vertical at 3 m								
No	Frequency (MHz)	Emission Level (dBuV/m)	Limit (dBuV/m)	Margin (dB)	Antenna Height (m)	Table Angle (Degree)	Raw Value (dBuV)	Correction Factor (dB/m)
1	126.02	29.7 QP	43.5	-13.8	1.00 V	28	44.1	-14.4
2	167.01	32.3 QP	43.5	-11.2	1.50 V	234	45.3	-13.0
3	223.61	31.4 QP	46.0	-14.6	1.00 V	141	47.4	-16.0
4	340.56	25.9 QP	46.0	-20.1	1.50 V	179	37.2	-11.3
5	499.50	25.0 QP	46.0	-21.0	1.50 V	49	32.6	-7.6
6	949.63	32.5 QP	46.0	-13.5	1.00 V	152	33.1	-0.6

Remarks:

1. Emission Level(dBuV/m) = Raw Value(dBuV) + Correction Factor(dB/m)
2. Correction Factor(dB/m) = Antenna Factor(dB/m) + Cable Factor(dB) – Pre-Amplifier Factor(dB)
3. Margin value = Emission Level – Limit value
4. The other emission levels were very low against the limit of frequency range 30MHz~1000MHz.
5. The emission levels were very low against the limit of frequency range 9kHz~30MHz: the amplitude of spurious emissions attenuated more than 20 dB below the permissible value to be report.

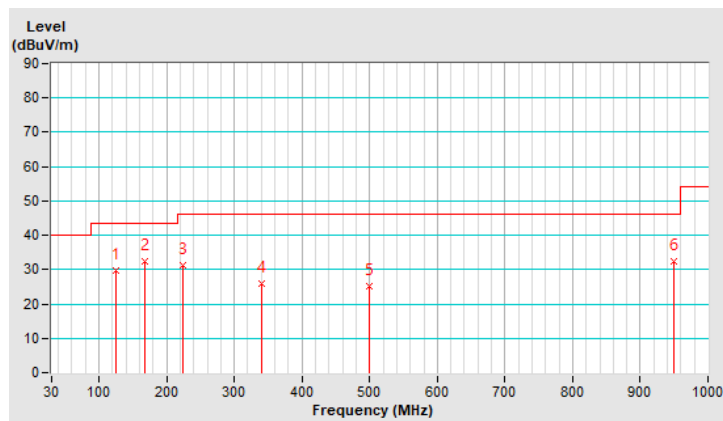

4.2 Conducted Emission Measurement

4.2.1 Limits of Conducted Emission Measurement

Frequency (MHz)	Conducted Limit (dBuV)	
	Quasi-peak	Average
0.15 - 0.5	66 - 56	56 - 46
0.50 - 5.0	56	46
5.0 - 30.0	60	50

Note: 1. The lower limit shall apply at the transition frequencies.

2. The limit decreases in line with the logarithm of the frequency in the range of 0.15 to 0.50MHz.

4.2.2 Test Instruments

DESCRIPTION & MANUFACTURER	MODEL NO.	SERIAL NO.	CALIBRATED DATE	CALIBRATED UNTIL
Test Receiver R&S	ESCS 30	847124/029	Oct. 20, 2020	Oct. 19, 2021
Line-Impedance Stabilization Network (for EUT) R&S	ESH3-Z5	848773/004	Oct. 27, 2020	Oct. 26, 2021
Line-Impedance Stabilization Network (for Peripheral) R&S	ESH3-Z5	835239/001	Mar. 26, 2021	Mar. 25, 2022
50 ohms Terminator	50	3	Oct. 26, 2020	Oct. 25, 2021
RF Cable	5D-FB	COCCAB-001	Sep. 26, 2020	Sep. 25, 2021
Fixed attenuator EMCI	STI02-2200-10	005	Aug. 29, 2020	Aug. 28, 2021
Software BVADT	BVADT_Cond_V7.3.7.4	NA	NA	NA

1. The calibration interval of the above test instruments are 12 months and the calibrations are traceable to NML/ROC and NIST/USA.
2. The test was performed in Conduction 1.
3. Tested Date: June 21, 2021

4.2.3 Test Procedures

- The EUT was placed 0.4 meters from the conducting wall of the shielded room with EUT being connected to the power mains through a line impedance stabilization network (LISN). Other support units were connected to the power mains through another LISN. The two LISNs provide 50 ohm/ 50uH of coupling impedance for the measuring instrument.
- Both lines of the power mains connected to the EUT were checked for maximum conducted interference.
- The frequency range from 150kHz to 30MHz was searched. Emission levels under (Limit - 20dB) was not recorded.

NOTE: The resolution bandwidth and video bandwidth of test receiver is 9kHz for quasi-peak detection (QP) and average detection (AV) at frequency 0.15MHz-30MHz.

4.2.4 Deviation from Test Standard

No deviation.

4.2.5 Test Setup

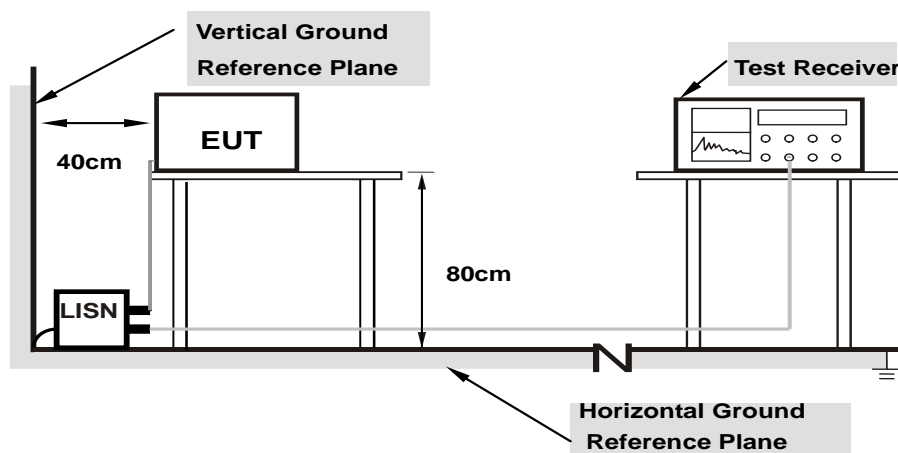

Note: 1.Support units were connected to second LISN.

For the actual test configuration, please refer to the attached file (Test Setup Photo).

4.2.6 EUT Operating Conditions

Same as 4.1.6.

4.2.7 Test Results (Mode 1)

RF Mode	TX BT_GFSK	Channel	CH 1 : 2404 MHz
Frequency Range	150kHz ~ 30MHz	Detector Function & Resolution Bandwidth	Quasi-Peak (QP) / Average (AV), 9kHz

Phase Of Power : Line (L)										
No	Frequency (MHz)	Correction Factor (dB)	Reading Value (dBuV)		Emission Level (dBuV)		Limit (dBuV)		Margin (dB)	
			Q.P.	AV.	Q.P.	AV.	Q.P.	AV.	Q.P.	AV.
1	0.15000	9.95	37.86	16.32	47.81	26.27	66.00	56.00	-18.19	-29.73
2	0.16172	9.95	37.91	21.41	47.86	31.36	65.38	55.38	-17.52	-24.02
3	0.20859	9.97	32.19	18.08	42.16	28.05	63.26	53.26	-21.10	-25.21
4	0.25547	9.98	26.42	10.68	36.40	20.66	61.58	51.58	-25.18	-30.92
5	0.40781	9.99	15.66	7.84	25.65	17.83	57.69	47.69	-32.04	-29.86
6	25.87500	11.24	24.25	24.09	35.49	35.33	60.00	50.00	-24.51	-14.67

Remarks:

1. Q.P. and AV. are abbreviations of quasi-peak and average individually.
2. The emission levels of other frequencies were very low against the limit.
3. Margin value = Emission level – Limit value
4. Correction factor = Insertion loss + Cable loss
5. Emission Level = Correction Factor + Reading Value

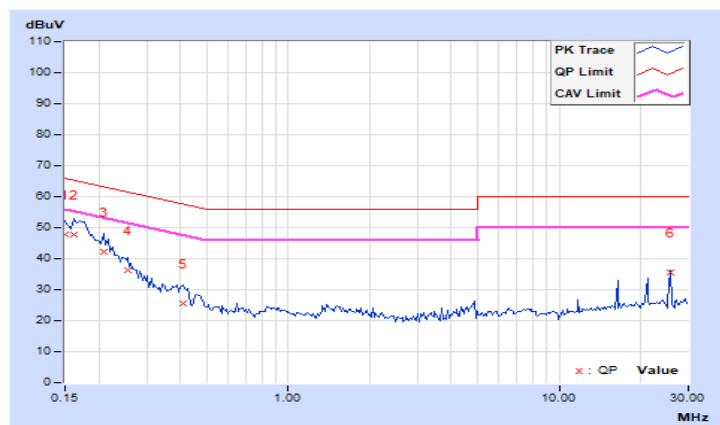

RF Mode	TX BT_GFSK	Channel	CH 1 : 2404 MHz
Frequency Range	150kHz ~ 30MHz	Detector Function & Resolution Bandwidth	Quasi-Peak (QP) / Average (AV), 9kHz

Phase Of Power : Neutral (N)										
No	Frequency (MHz)	Correction Factor (dB)	Reading Value (dBuV)		Emission Level (dBuV)		Limit (dBuV)		Margin (dB)	
			Q.P.	AV.	Q.P.	AV.	Q.P.	AV.	Q.P.	AV.
1	0.15781	9.92	42.03	21.55	51.95	31.47	65.58	55.58	-13.63	-24.11
2	0.18516	9.94	39.70	22.13	49.64	32.07	64.25	54.25	-14.61	-22.18
3	0.22422	9.95	29.23	13.72	39.18	23.67	62.66	52.66	-23.48	-28.99
4	0.41953	9.96	16.43	10.74	26.39	20.70	57.46	47.46	-31.07	-26.76
5	2.38281	10.06	12.58	2.16	22.64	12.22	56.00	46.00	-33.36	-33.78
6	25.87500	10.91	24.92	24.63	35.83	35.54	60.00	50.00	-24.17	-14.46

Remarks:

1. Q.P. and AV. are abbreviations of quasi-peak and average individually.
2. The emission levels of other frequencies were very low against the limit.
3. Margin value = Emission level – Limit value
4. Correction factor = Insertion loss + Cable loss
5. Emission Level = Correction Factor + Reading Value

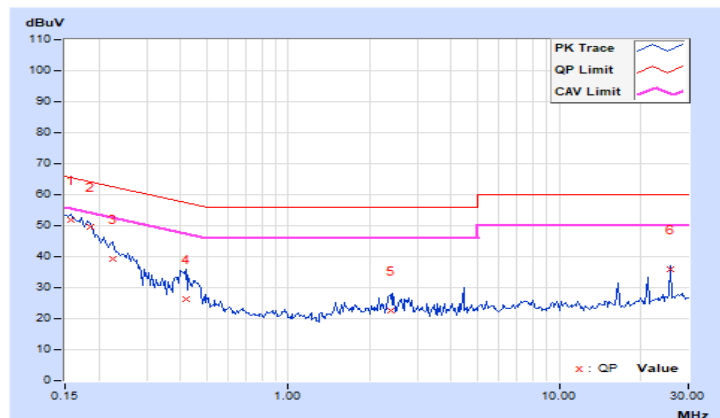

4.2.8 Test Results (Mode 2)

RF Mode	TX BT_GFSK	Channel	CH 1 : 2404 MHz
Frequency Range	150kHz ~ 30MHz	Detector Function & Resolution Bandwidth	Quasi-Peak (QP) / Average (AV), 9kHz

Phase Of Power : Line (L)										
No	Frequency (MHz)	Correction Factor (dB)	Reading Value (dBuV)		Emission Level (dBuV)		Limit (dBuV)		Margin (dB)	
			Q.P.	AV.	Q.P.	AV.	Q.P.	AV.	Q.P.	AV.
1	0.15391	9.95	40.26	20.58	50.21	30.53	65.79	55.79	-15.58	-25.26
2	0.16172	9.95	38.10	21.80	48.05	31.75	65.38	55.38	-17.33	-23.63
3	0.17344	9.96	38.34	22.50	48.30	32.46	64.79	54.79	-16.49	-22.33
4	0.21641	9.97	30.89	16.07	40.86	26.04	62.96	52.96	-22.10	-26.92
5	0.38828	9.99	16.80	8.11	26.79	18.10	58.10	48.10	-31.31	-30.00
6	25.87500	11.24	24.11	23.83	35.35	35.07	60.00	50.00	-24.65	-14.93

Remarks:

1. Q.P. and AV. are abbreviations of quasi-peak and average individually.
2. The emission levels of other frequencies were very low against the limit.
3. Margin value = Emission level – Limit value
4. Correction factor = Insertion loss + Cable loss
5. Emission Level = Correction Factor + Reading Value

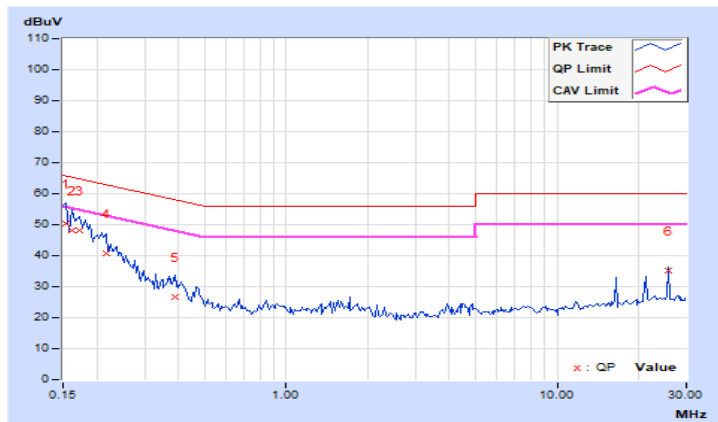

RF Mode	TX BT_GFSK	Channel	CH 1 : 2404 MHz
Frequency Range	150kHz ~ 30MHz	Detector Function & Resolution Bandwidth	Quasi-Peak (QP) / Average (AV), 9kHz

Phase Of Power : Neutral (N)										
No	Frequency (MHz)	Correction Factor (dB)	Reading Value (dBuV)		Emission Level (dBuV)		Limit (dBuV)		Margin (dB)	
			Q.P.	AV.	Q.P.	AV.	Q.P.	AV.	Q.P.	AV.
1	0.15000	9.92	38.80	17.69	48.72	27.61	66.00	56.00	-17.28	-28.39
2	0.16172	9.93	38.18	19.56	48.11	29.49	65.38	55.38	-17.27	-25.89
3	0.20859	9.95	32.63	17.54	42.58	27.49	63.26	53.26	-20.68	-25.77
4	0.25547	9.95	26.18	9.48	36.13	19.43	61.58	51.58	-25.45	-32.15
5	0.41953	9.96	21.56	11.44	31.52	21.40	57.46	47.46	-25.94	-26.06
6	25.87500	10.91	24.97	24.67	35.88	35.58	60.00	50.00	-24.12	-14.42

Remarks:

1. Q.P. and AV. are abbreviations of quasi-peak and average individually.
2. The emission levels of other frequencies were very low against the limit.
3. Margin value = Emission level – Limit value
4. Correction factor = Insertion loss + Cable loss
5. Emission Level = Correction Factor + Reading Value

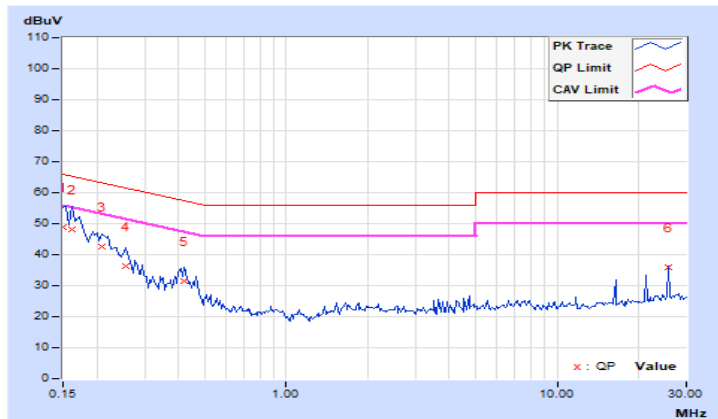

4.3 6dB Bandwidth Measurement

4.3.1 Limits of 6dB Bandwidth Measurement

The minimum of 6dB Bandwidth Measurement is 0.5 MHz.

4.3.2 Test Setup

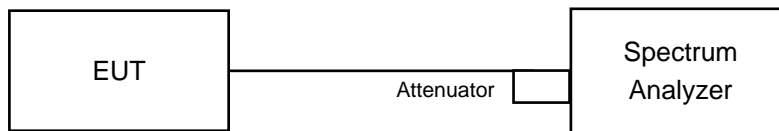

4.3.3 Test Instruments

Refer to section 4.1.2 to get information of above instrument.

4.3.4 Test Procedure

- a. Set resolution bandwidth (RBW) = 100kHz
- b. Set the video bandwidth (VBW) $\geq 3 \times$ RBW, Detector = Peak
- c. Trace mode = max hold
- d. Sweep = auto couple
- e. Measure the maximum width of the emission that is constrained by the frequencies associated with the two amplitude points (upper and lower) that are attenuated by 6 dB relative to the maximum level measured in the fundamental emission.

4.3.5 Deviation from Test Standard

No deviation.

4.3.6 EUT Operating Conditions

The software provided by client to enable the EUT under transmission condition continuously at lowest, middle and highest channel frequencies individually.

4.3.7 Test Results (Mode 1)

BT-LE 1M

Channel	Frequency (MHz)	6dB Bandwidth (MHz)	Minimum Limit (MHz)	Pass / Fail
0	2402	0.67	0.5	Pass
19	2440	0.67	0.5	Pass
39	2480	0.68	0.5	Pass

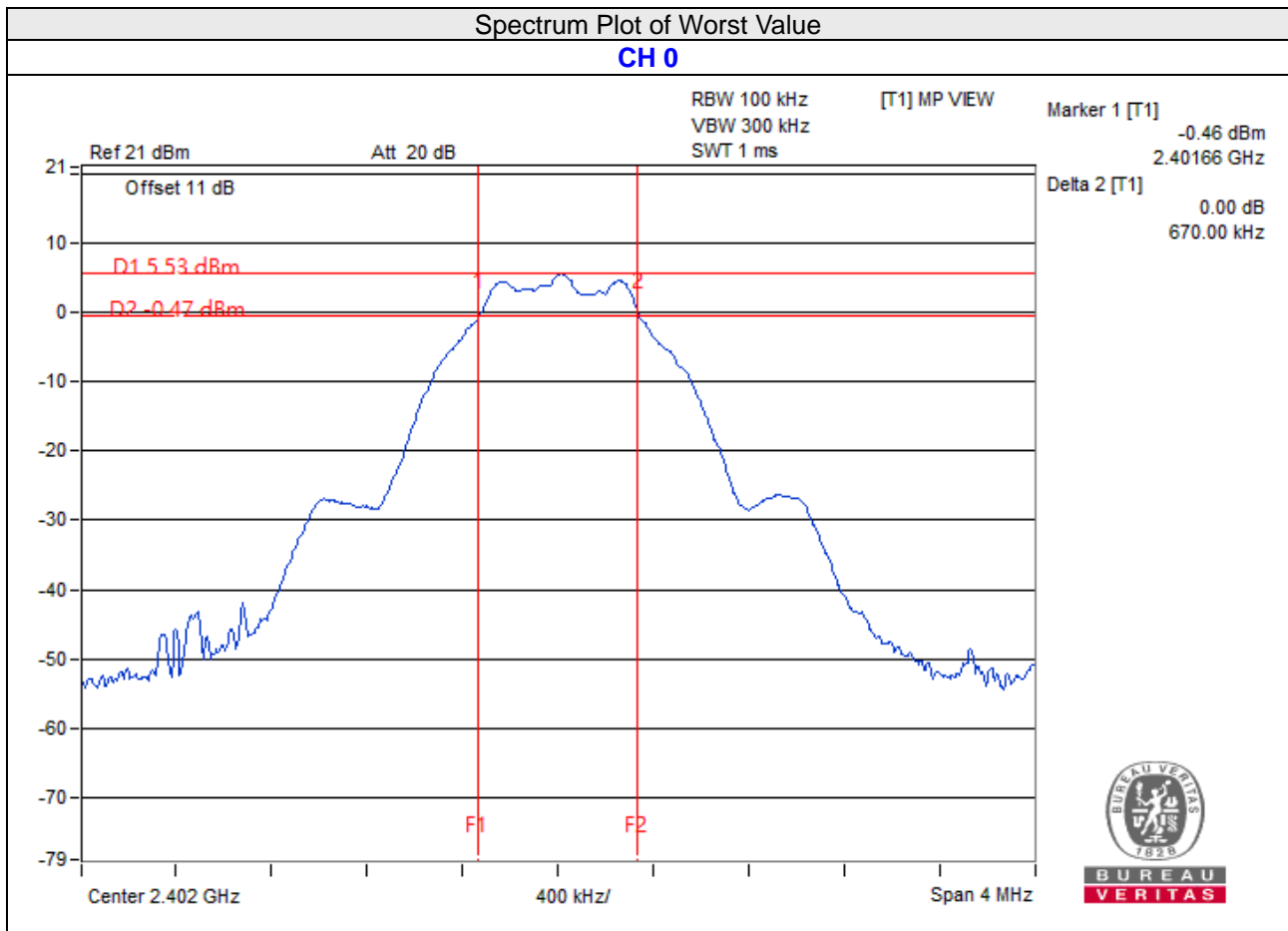

BT-LE 2M

Channel	Frequency (MHz)	6dB Bandwidth (MHz)	Minimum Limit (MHz)	Pass / Fail
1	2404	1.14	0.5	Pass
19	2440	1.14	0.5	Pass
38	2478	0.96	0.5	Pass

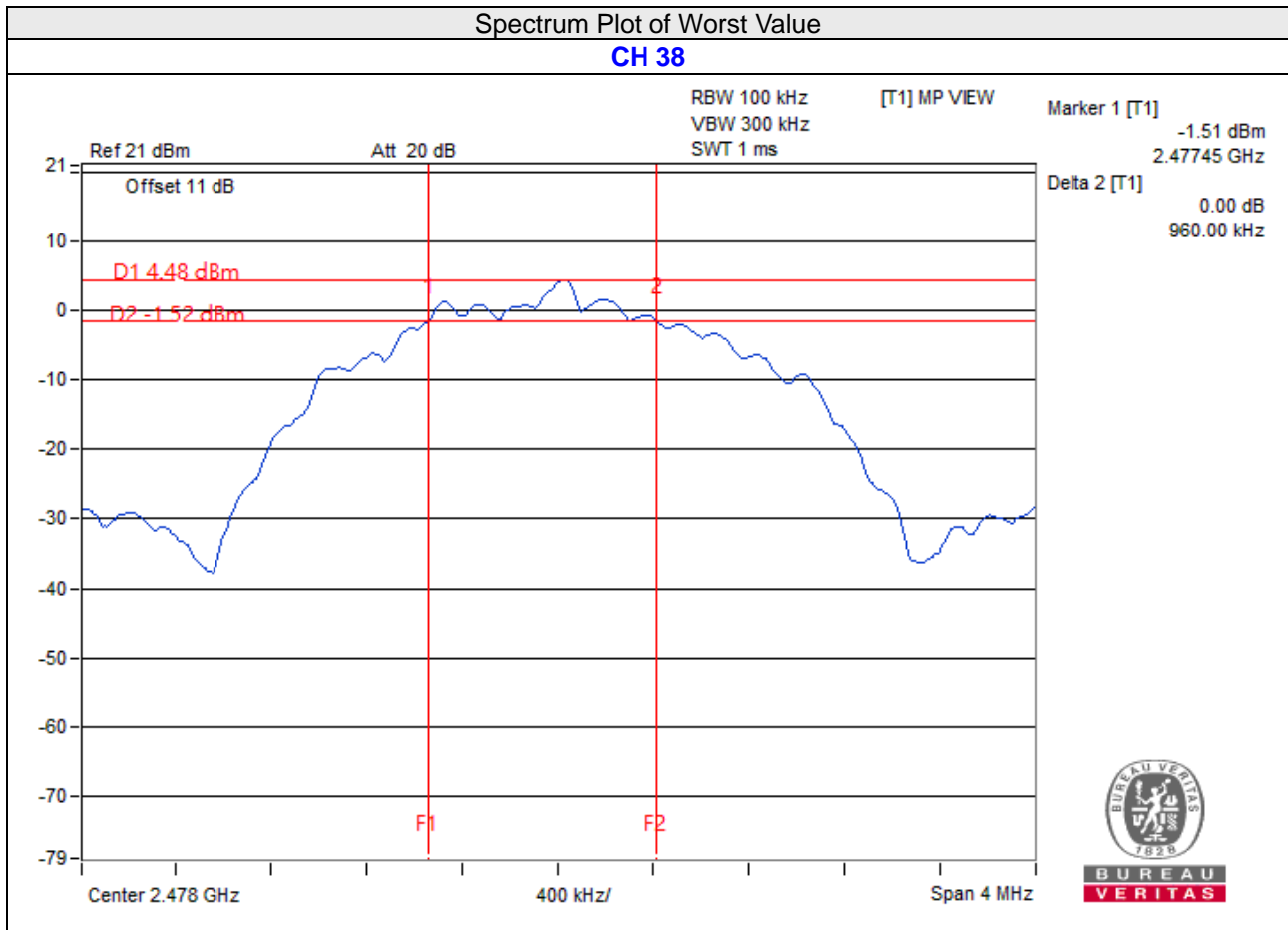

4.3.8 Test Results (Mode 2)

BT-LE 1M

Channel	Frequency (MHz)	6dB Bandwidth (MHz)	Minimum Limit (MHz)	Pass / Fail
0	2402	0.67	0.5	Pass
19	2440	0.67	0.5	Pass
39	2480	0.67	0.5	Pass

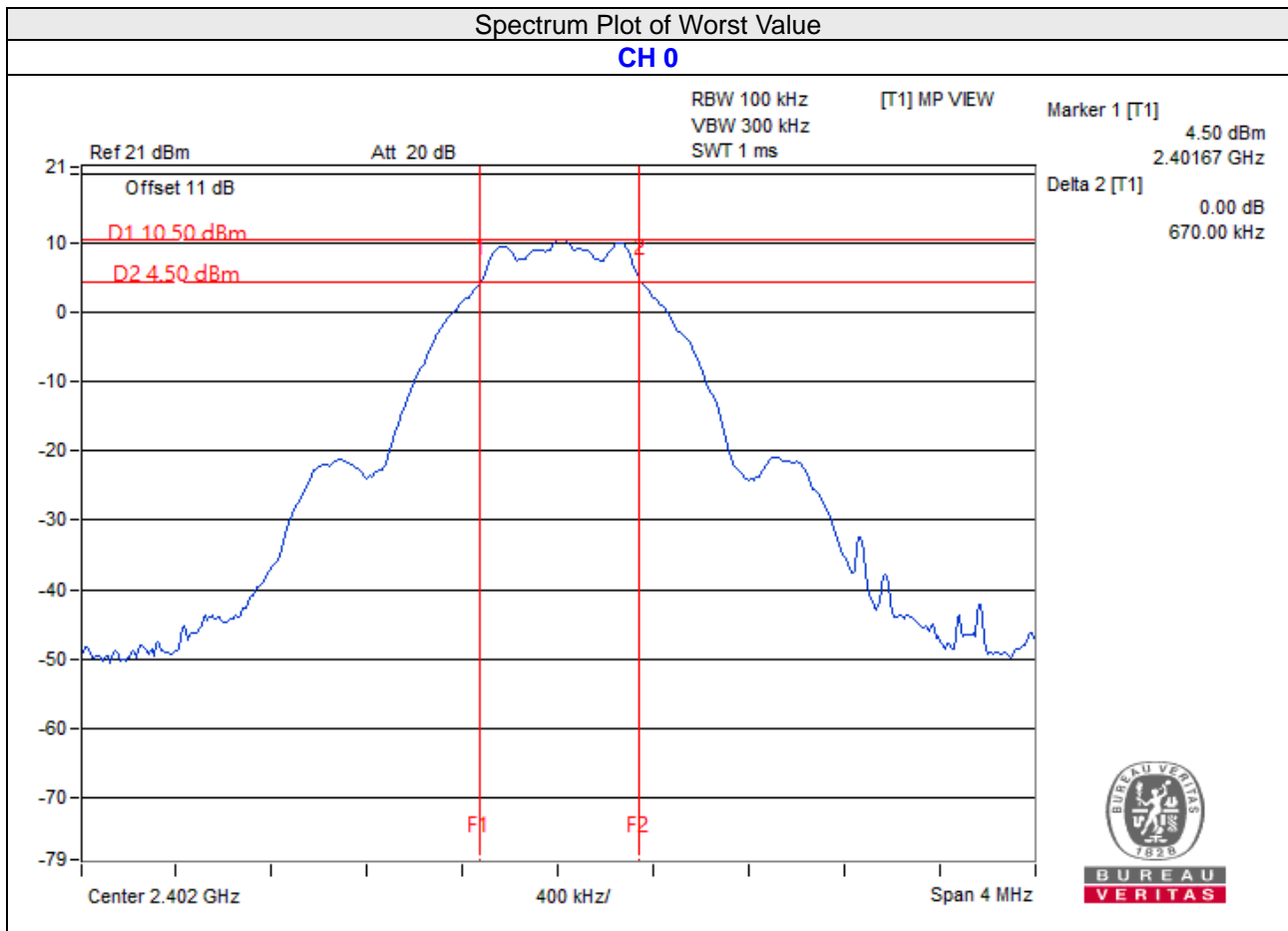

4.4 Conducted Output Power Measurement

4.4.1 Limits OF Conducted Output Power Measurement

For systems using digital modulation in the 2400–2483.5 MHz bands: 1 Watt (30dBm)

4.4.2 Test Setup

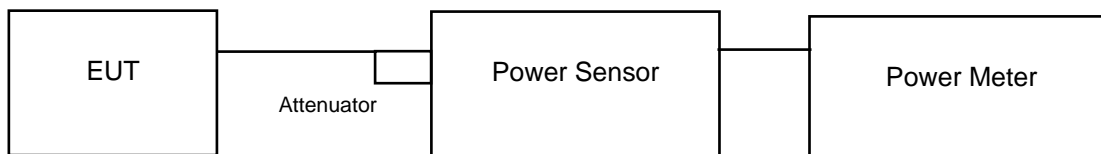

4.4.3 Test Instruments

Refer to section 4.1.2 to get information of above instrument.

4.4.4 Test Procedures

A peak power sensor was used on the output port of the EUT. A power meter was used to read the response of the peak power sensor. Record the power level.

Average power sensor was used to perform output power measurement, trigger and gating function of wide band power meter is enabled to measure max output power of TX on burst. Duty factor is not added to measured value..

4.4.5 Deviation from Test Standard

No deviation.

4.4.6 EUT Operating Conditions

Same as Item 4.3.6.

4.4.7 Test Results (Mode 1)

BT-LE 1M

FOR PEAK POWER

Channel	Frequency (MHz)	Peak Power (mW)	Peak Power (dBm)	Limit (dBm)	Pass/Fail
0	2402	4.519	6.55	30	Pass
19	2440	4.55	6.58	30	Pass
39	2480	4.645	6.67	30	Pass

FOR AVERAGE POWER

Channel	Frequency (MHz)	Average Power (mW)	Average Power (dBm)
0	2402	3.99	6.01
19	2440	4.009	6.03
39	2480	4.046	6.07

BT-LE 2M

FOR PEAK POWER

Channel	Frequency (MHz)	Peak Power (mW)	Peak Power (dBm)	Limit (dBm)	Pass/Fail
1	2404	4.56	6.59	30	Pass
19	2440	4.624	6.65	30	Pass
38	2478	4.71	6.73	30	Pass

FOR AVERAGE POWER

Channel	Frequency (MHz)	Average Power (mW)	Average Power (dBm)
1	2404	3.963	5.98
19	2440	3.972	5.99
38	2478	4.009	6.03

4.4.8 Test Results (Mode 2)

BT-LE 1M

FOR PEAK POWER

Channel	Frequency (MHz)	Peak Power (mW)	Peak Power (dBm)	Limit (dBm)	Pass/Fail
0	2402	17.824	12.51	30	Pass
19	2440	17.947	12.54	30	Pass
39	2480	17.742	12.49	30	Pass

FOR AVERAGE POWER

Channel	Frequency (MHz)	Average Power (mW)	Average Power (dBm)
0	2402	17.179	12.35
19	2440	17.258	12.37
39	2480	17.1	12.33

BT-LE 2M

FOR PEAK POWER

Channel	Frequency (MHz)	Peak Power (mW)	Peak Power (dBm)	Limit (dBm)	Pass/Fail
1	2404	18.03	12.56	30	Pass
19	2440	17.906	12.53	30	Pass
38	2478	17.66	12.47	30	Pass

FOR AVERAGE POWER

Channel	Frequency (MHz)	Average Power (mW)	Average Power (dBm)
1	2404	17.298	12.38
19	2440	17.061	12.32
38	2478	17.022	12.31

4.5 Power Spectral Density Measurement

4.5.1 Limits of Power Spectral Density Measurement

The Maximum of Power Spectral Density Measurement is 8dBm in any 3kHz.

4.5.2 Test Setup

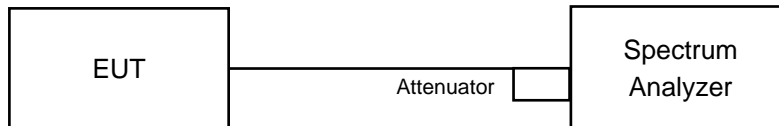

4.5.3 Test Instruments

Refer to section 4.1.2 to get information of above instrument.

4.5.4 Test Procedure

- a. Set analyzer center frequency to DTS channel center frequency.
- b. Set the span to 1.5 times the DTS bandwidth.
- c. Set the RBW to: $3 \text{ kHz} \leq \text{RBW} \leq 100 \text{ kHz}$.
- d. Set the VBW $\geq 3 \times \text{RBW}$.
- e. Detector = peak.
- f. Sweep time = auto couple.
- g. Trace mode = max hold.
- h. Allow trace to fully stabilize.
- i. Use the peak marker function to determine the maximum amplitude level within the RBW.

4.5.5 Deviation from Test Standard

No deviation.

4.5.6 EUT Operating Condition

Same as Item 4.3.6

4.5.7 Test Results (Mode 1)

BT-LE 1M

Channel	Freq. (MHz)	PSD (dBm/3kHz)	Limit (dBm/3kHz)	Pass /Fail
0	2402	-9.69	8	Pass
19	2440	-10.12	8	Pass
39	2480	-10.38	8	Pass

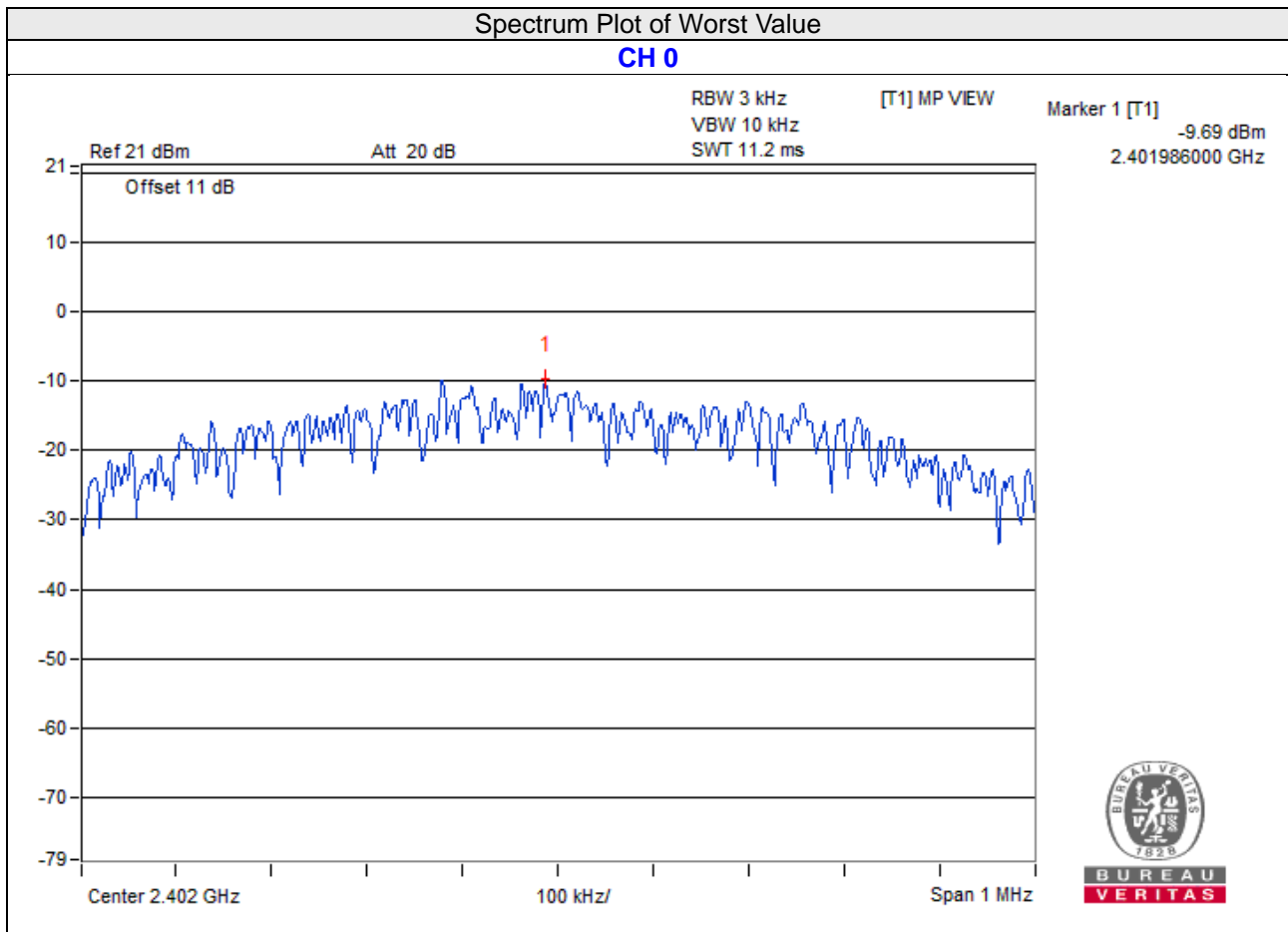

BT-LE 2M

Channel	Freq. (MHz)	PSD (dBm/3kHz)	Limit (dBm/3kHz)	Pass /Fail
1	2404	-12.61	8	Pass
19	2440	-12.41	8	Pass
38	2478	-13.01	8	Pass

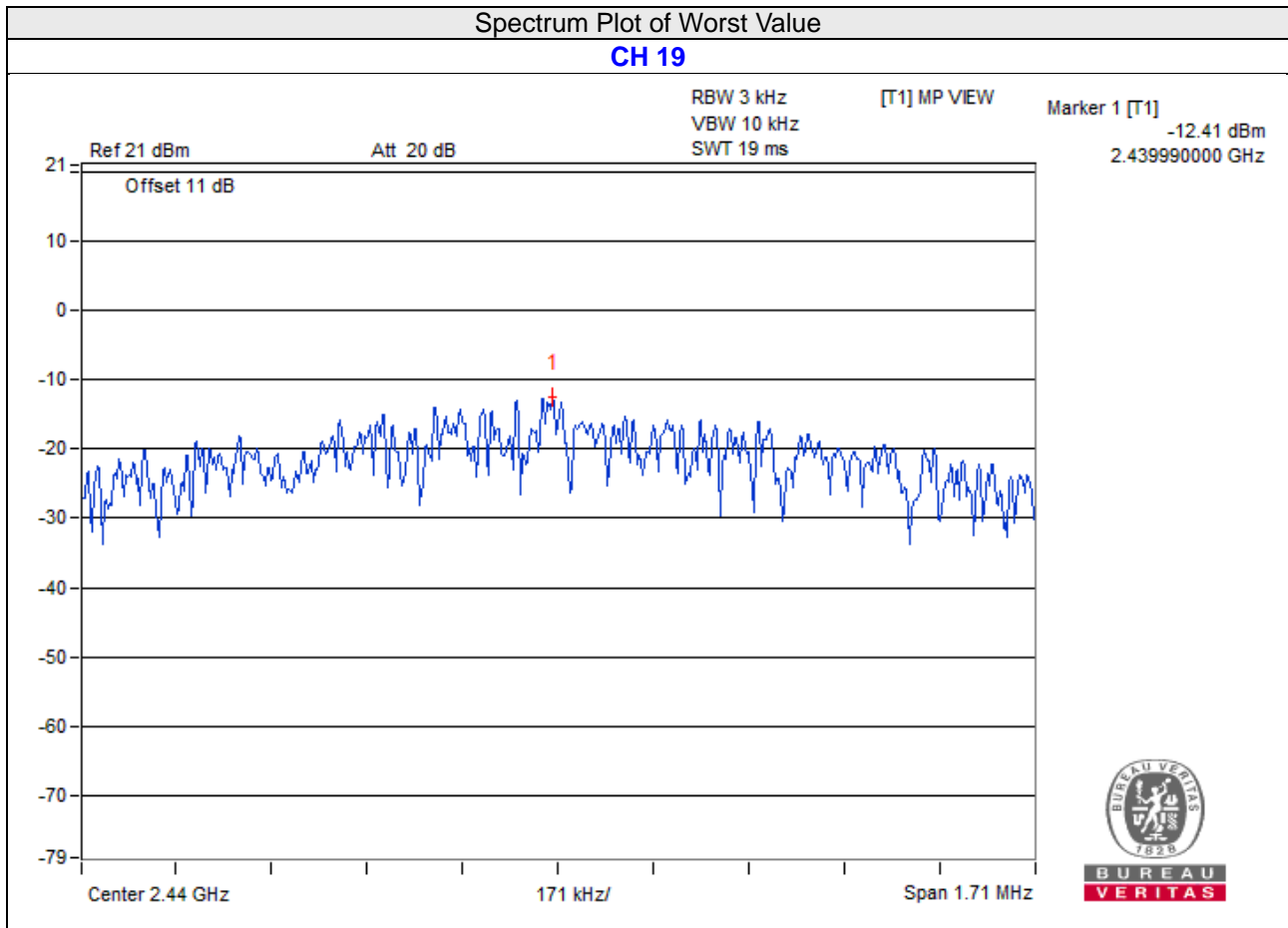

4.5.8 Test Results (Mode 2)

BT-LE 1M

Channel	Freq. (MHz)	PSD (dBm/3kHz)	Limit (dBm/3kHz)	Pass /Fail
0	2402	-3.25	8	Pass
19	2440	-2.26	8	Pass
39	2480	-5.80	8	Pass

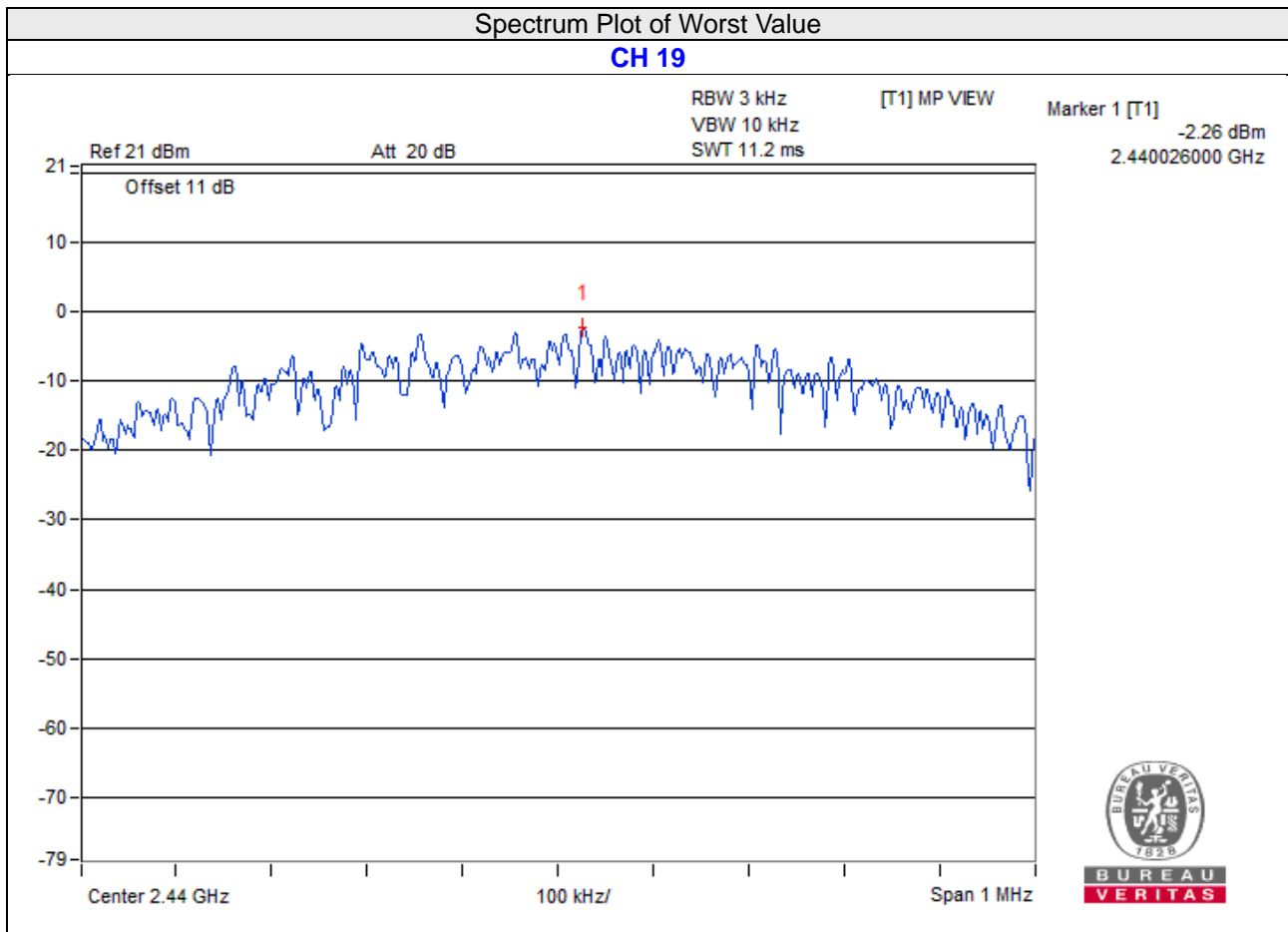

BT-LE 2M

Channel	Freq. (MHz)	PSD (dBm/3kHz)	Limit (dBm/3kHz)	Pass /Fail
1	2404	-4.92	8	Pass
19	2440	-4.25	8	Pass
38	2478	-5.53	8	Pass

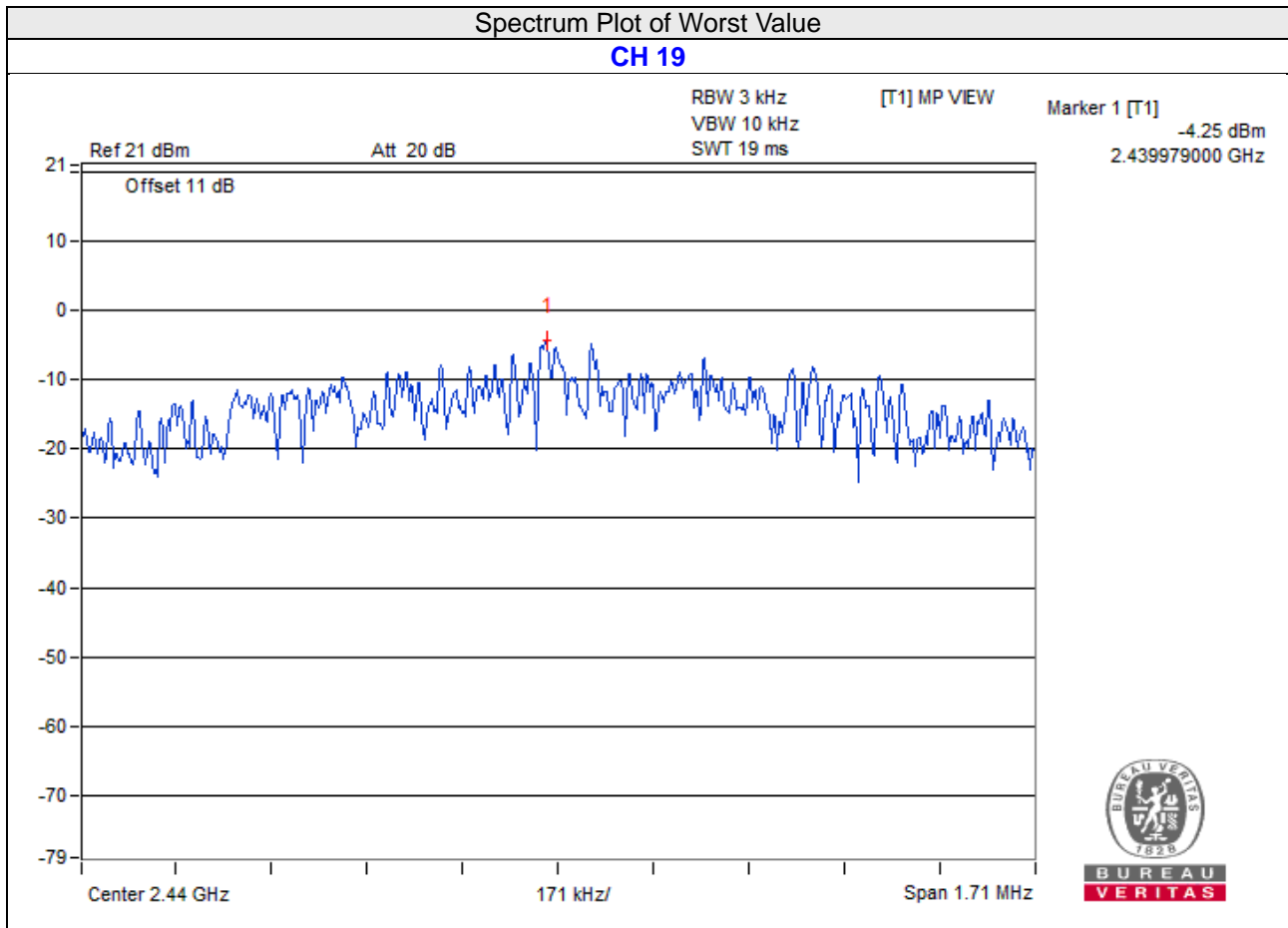

4.6 Conducted Out of Band Emission Measurement

4.6.1 Limits of Conducted Out of Band Emission Measurement

Below -20dB of the highest emission level of operating band (in 100kHz Resolution Bandwidth).

4.6.2 Test Setup

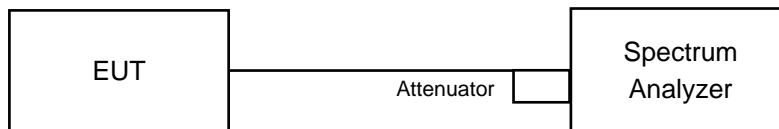

4.6.3 Test Instruments

Refer to section 4.1.2 to get information of above instrument.

4.6.4 Test Procedure

MEASUREMENT PROCEDURE REF

1. Set the RBW = 100 kHz.
2. Set the VBW \geq 300 kHz.
3. Detector = peak.
4. Sweep time = auto couple.
5. Trace mode = max hold.
6. Allow trace to fully stabilize.
7. Use the peak marker function to determine the maximum power level in any 100 kHz band segment within the fundamental EBW.

MEASUREMENT PROCEDURE OOB

1. Set RBW = 100 kHz.
2. Set VBW \geq 300 kHz.
3. Detector = peak.
4. Sweep = auto couple.
5. Trace Mode = max hold.
6. Allow trace to fully stabilize.
7. Use the peak marker function to determine the maximum amplitude level.

4.6.5 Deviation from Test Standard

No deviation.

4.6.6 EUT Operating Condition

Same as Item 4.3.6

4.6.7 Test Results (Mode 1)

BT-LE 1M

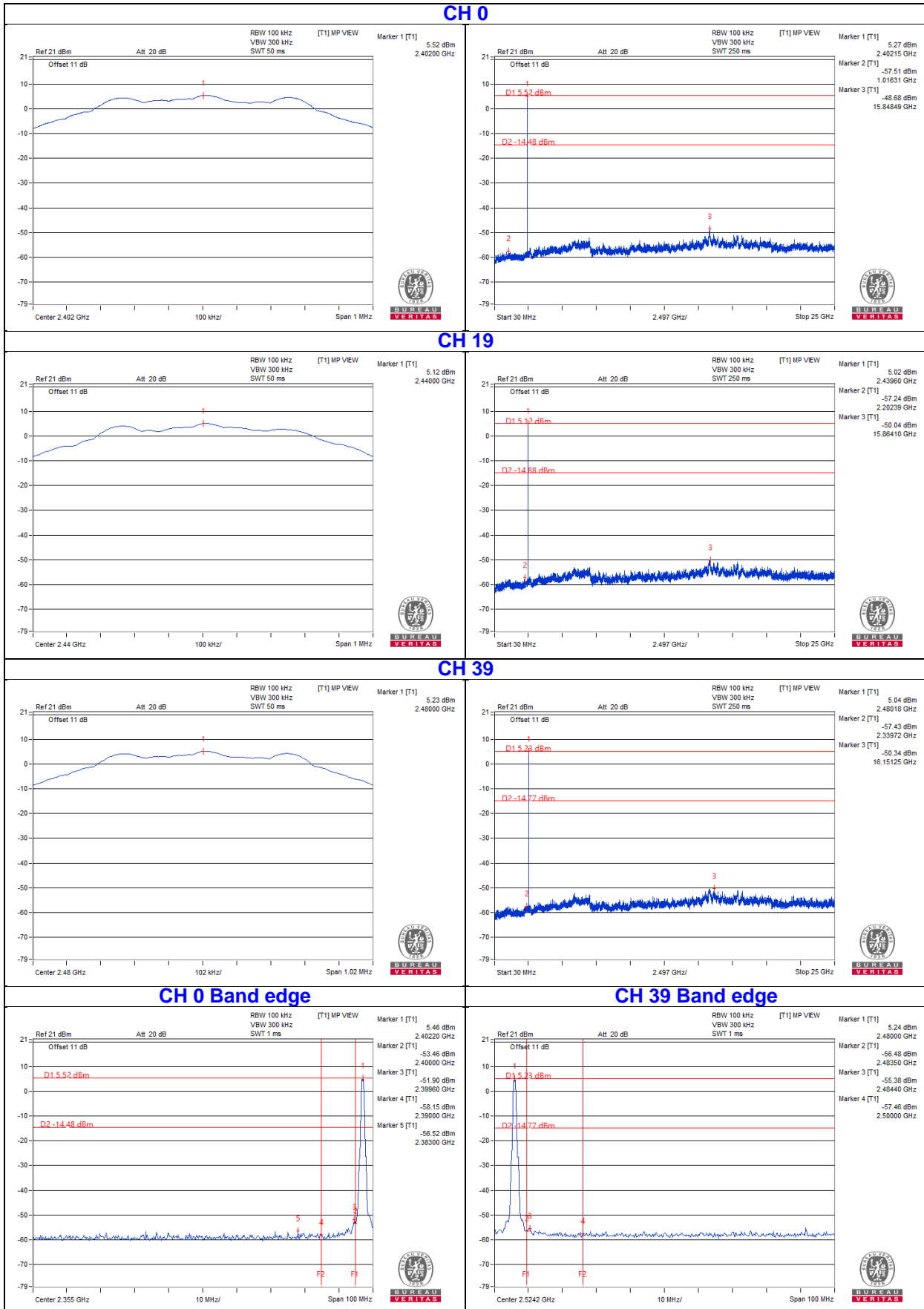

BT-LE 2M

CH 1

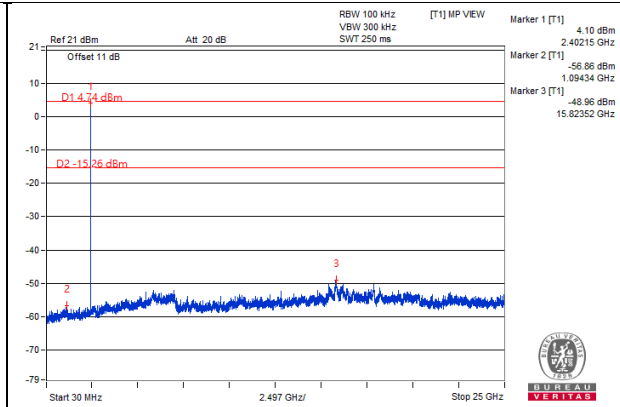
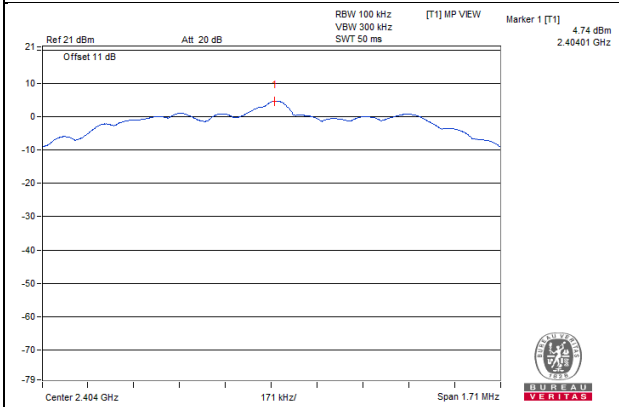

CH 19

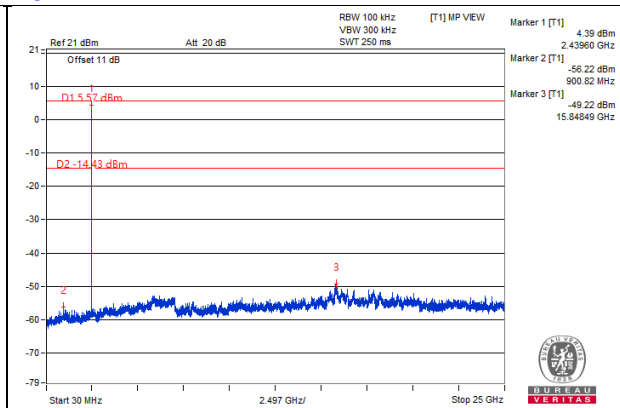
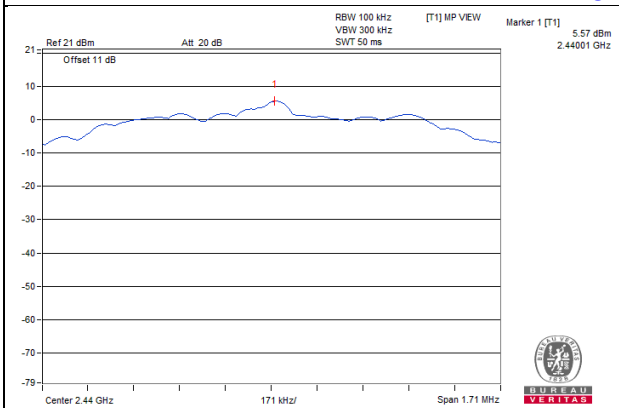

CH 38

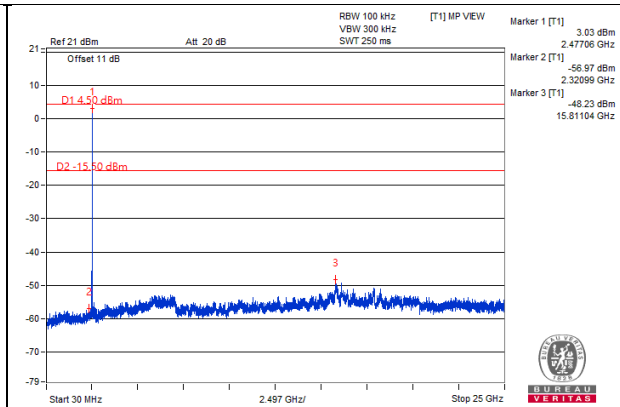
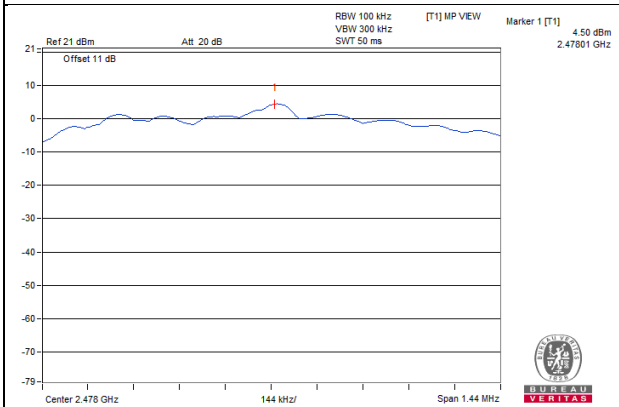

CH 1 Band edge

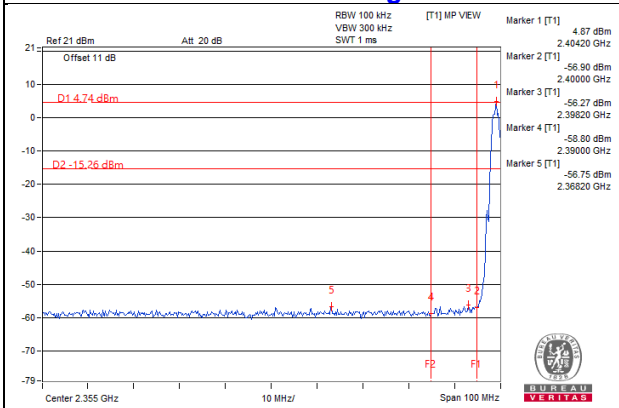

CH 38 Band edge

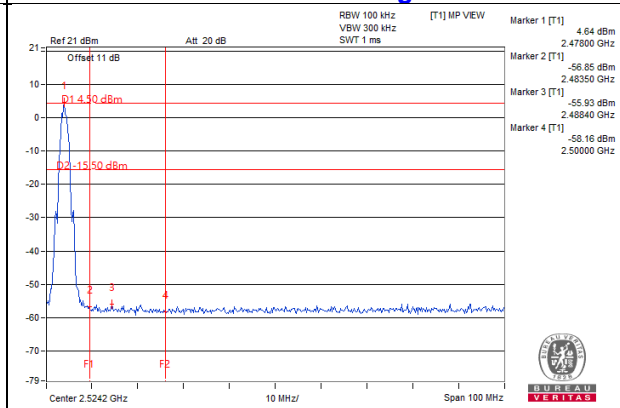

4.6.8 Test Results (Mode 2)

BT-LE 1M

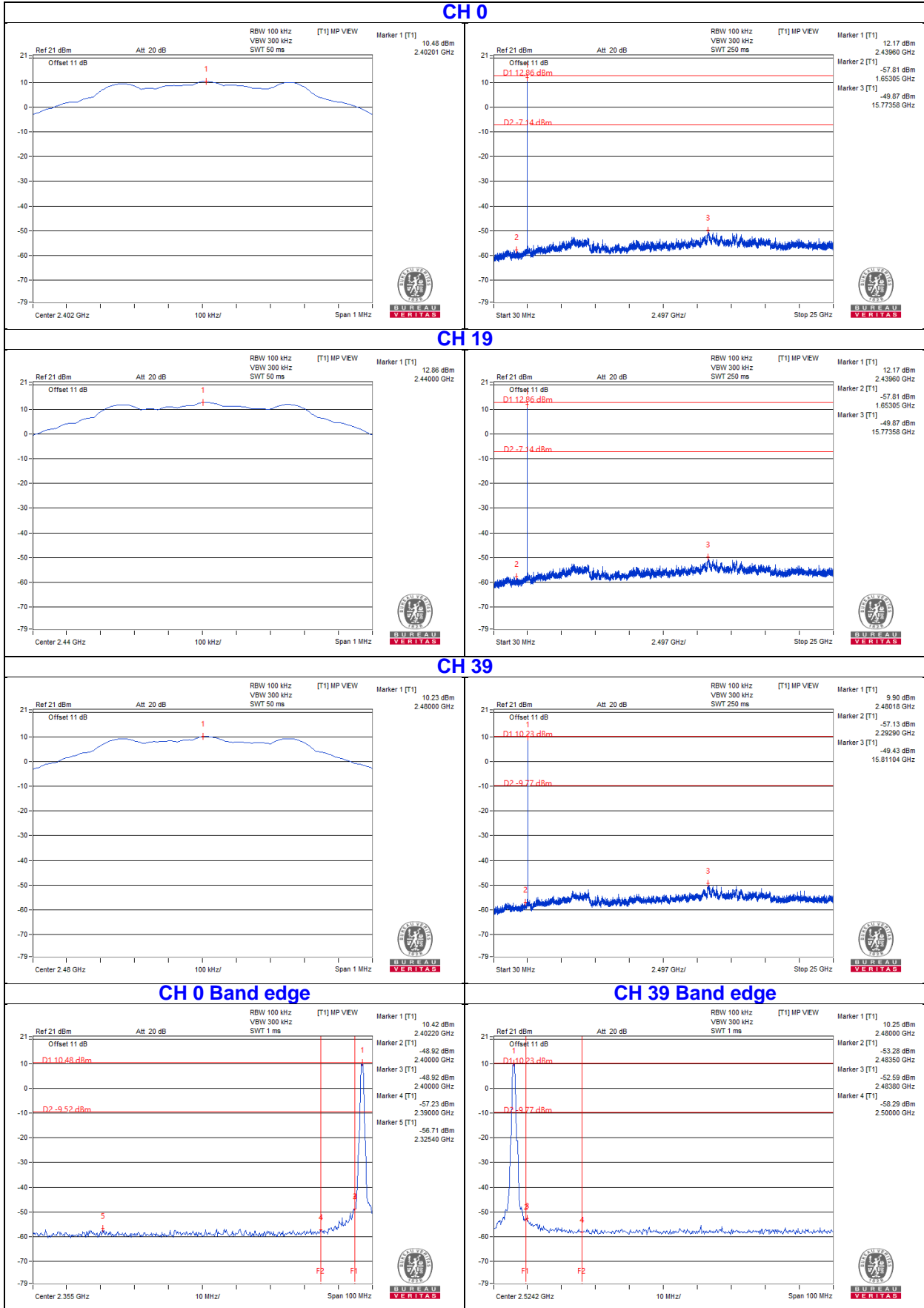

BT-LE 2M

CH 1

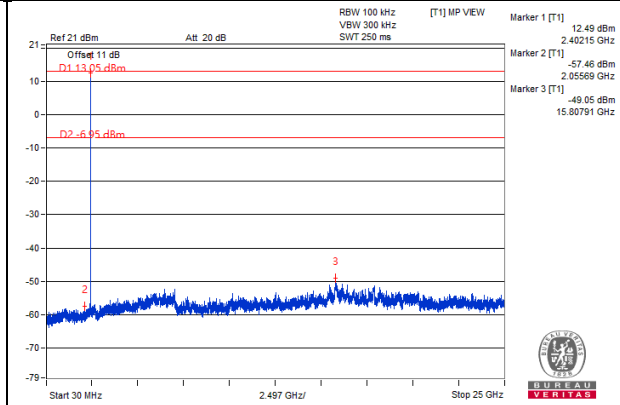
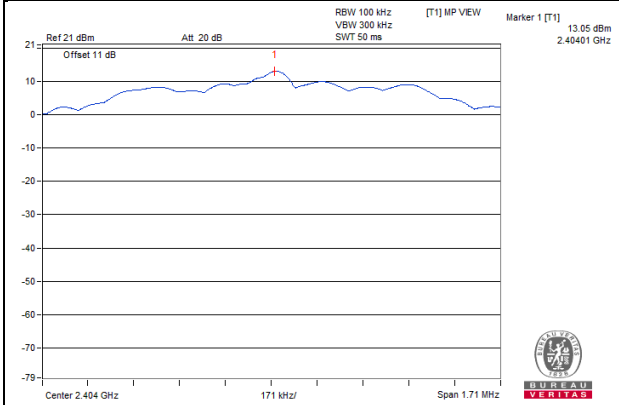

CH 19

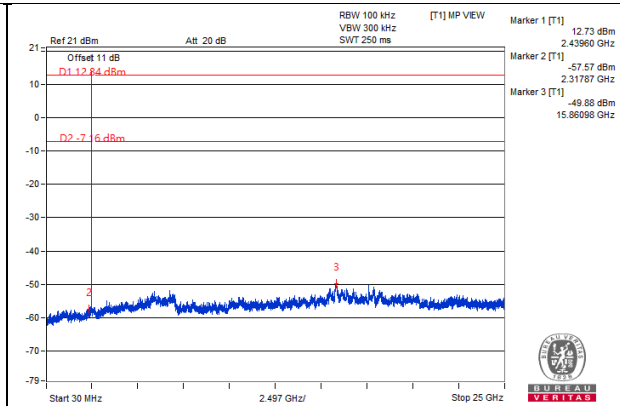
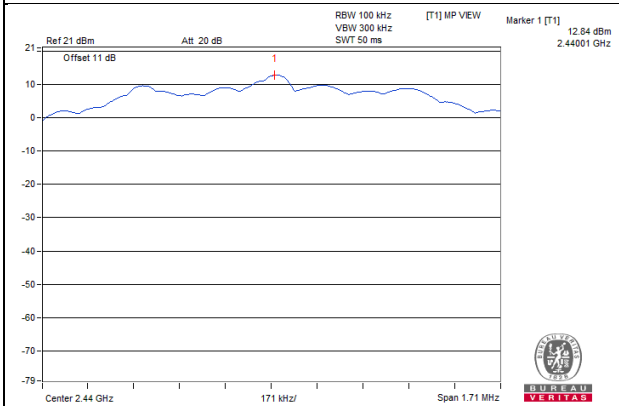

CH 38

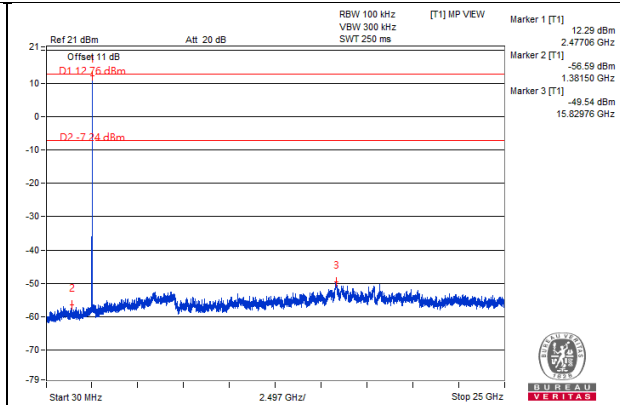
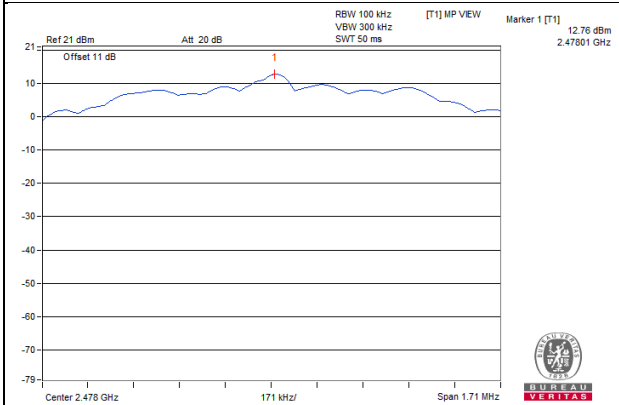

CH 1 Band edge

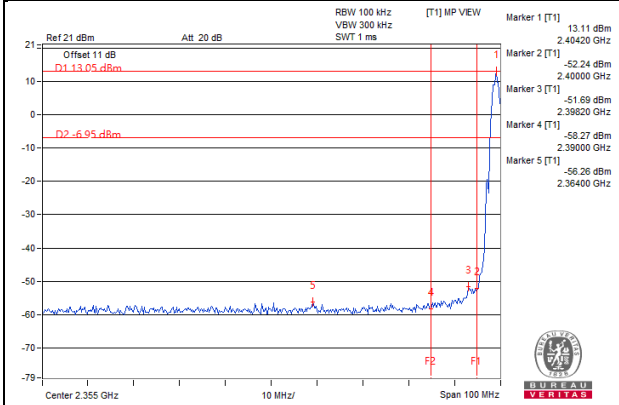

CH 38 Band edge

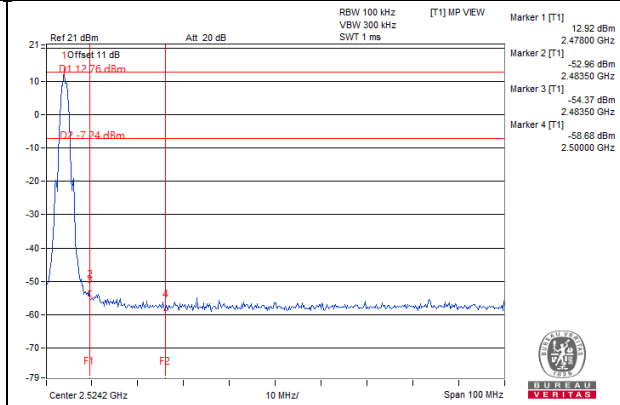

5 Pictures of Test Arrangements

Please refer to the attached file (Test Setup Photo).

Annex A - Band-Edge Measurement
Annex A.1 - Test Results (Mode 1)
Dipole Antenna
BT-LE 1M

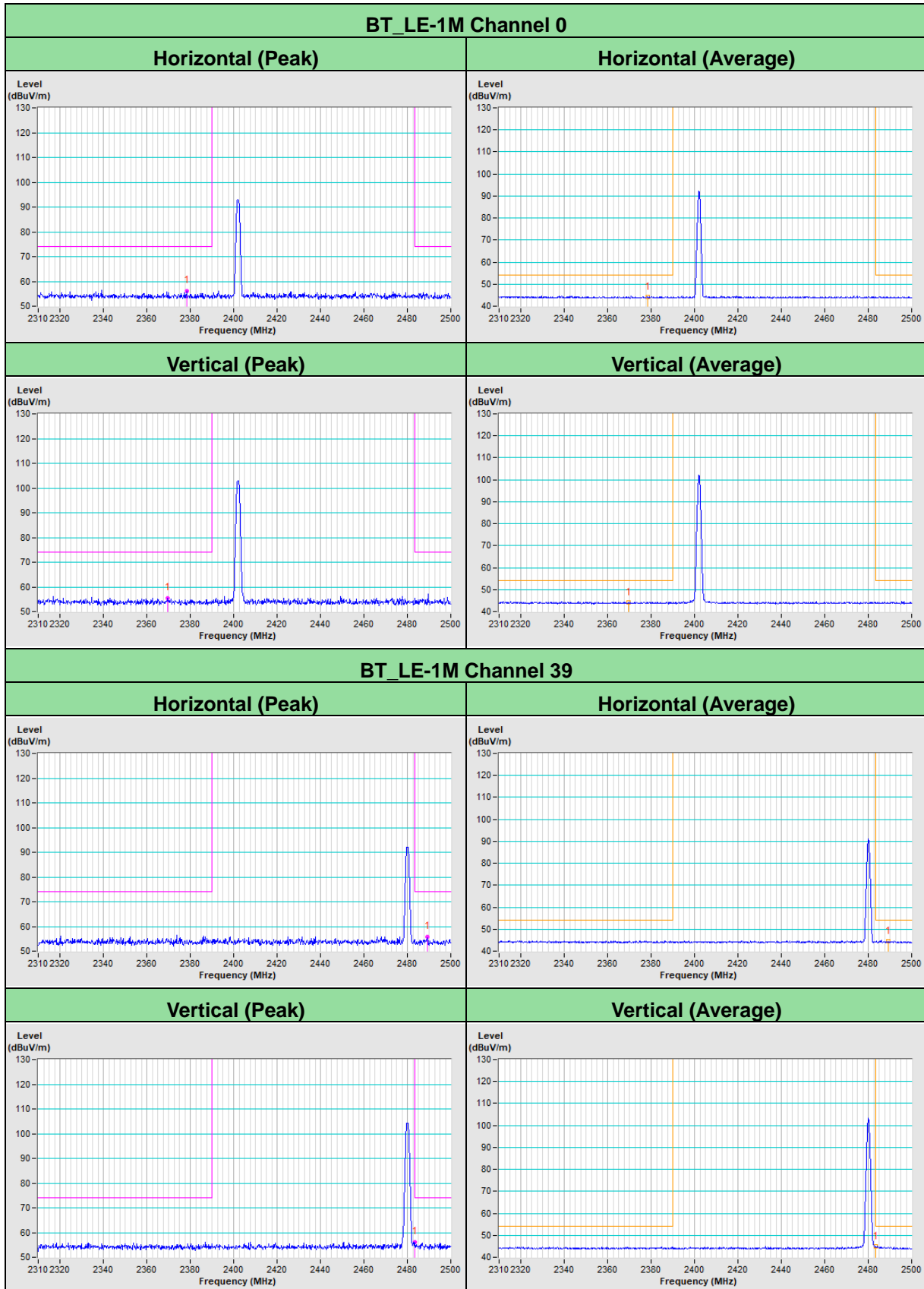

BT-LE 2M

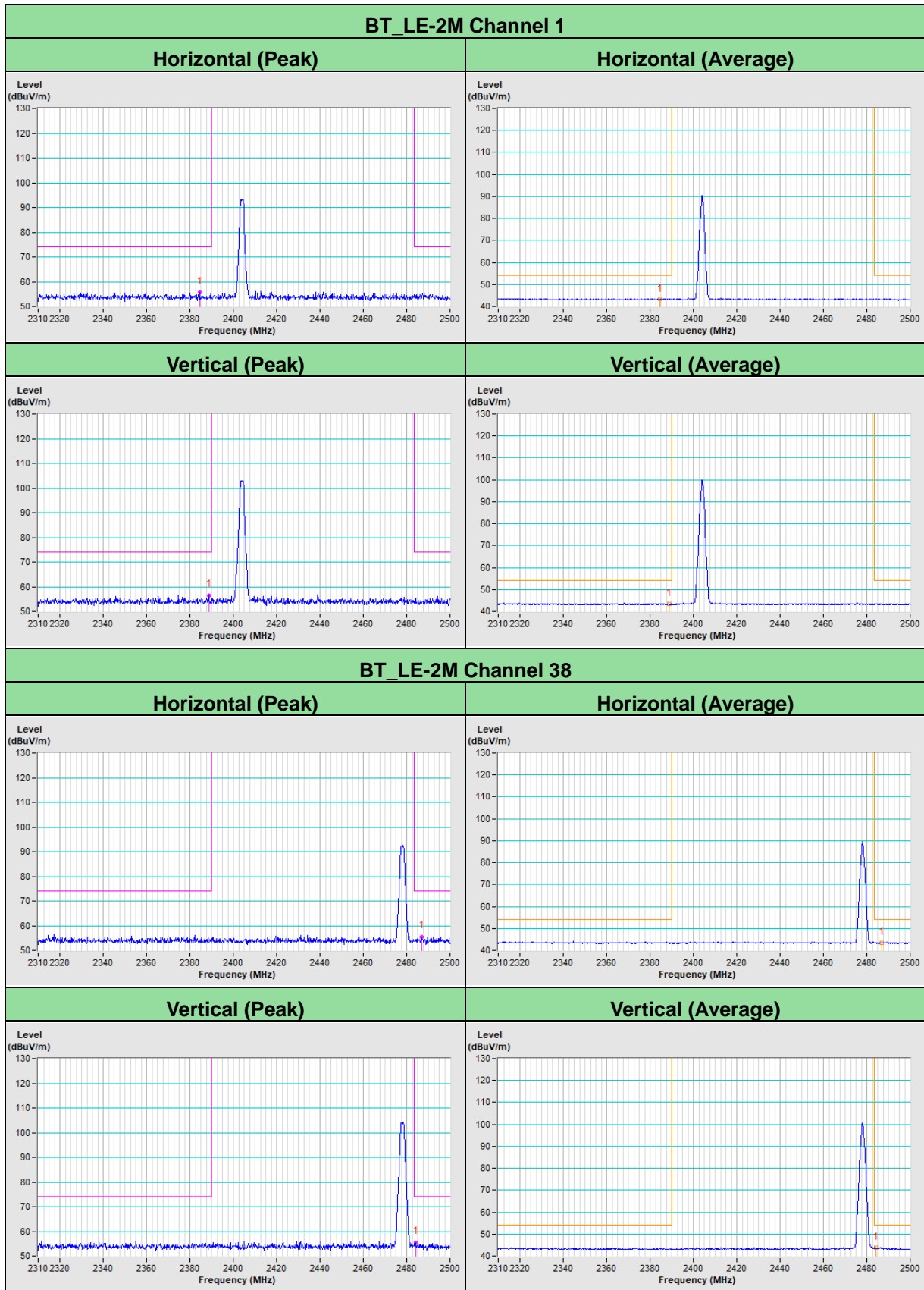

PIFA Antenna

BT-LE 1M

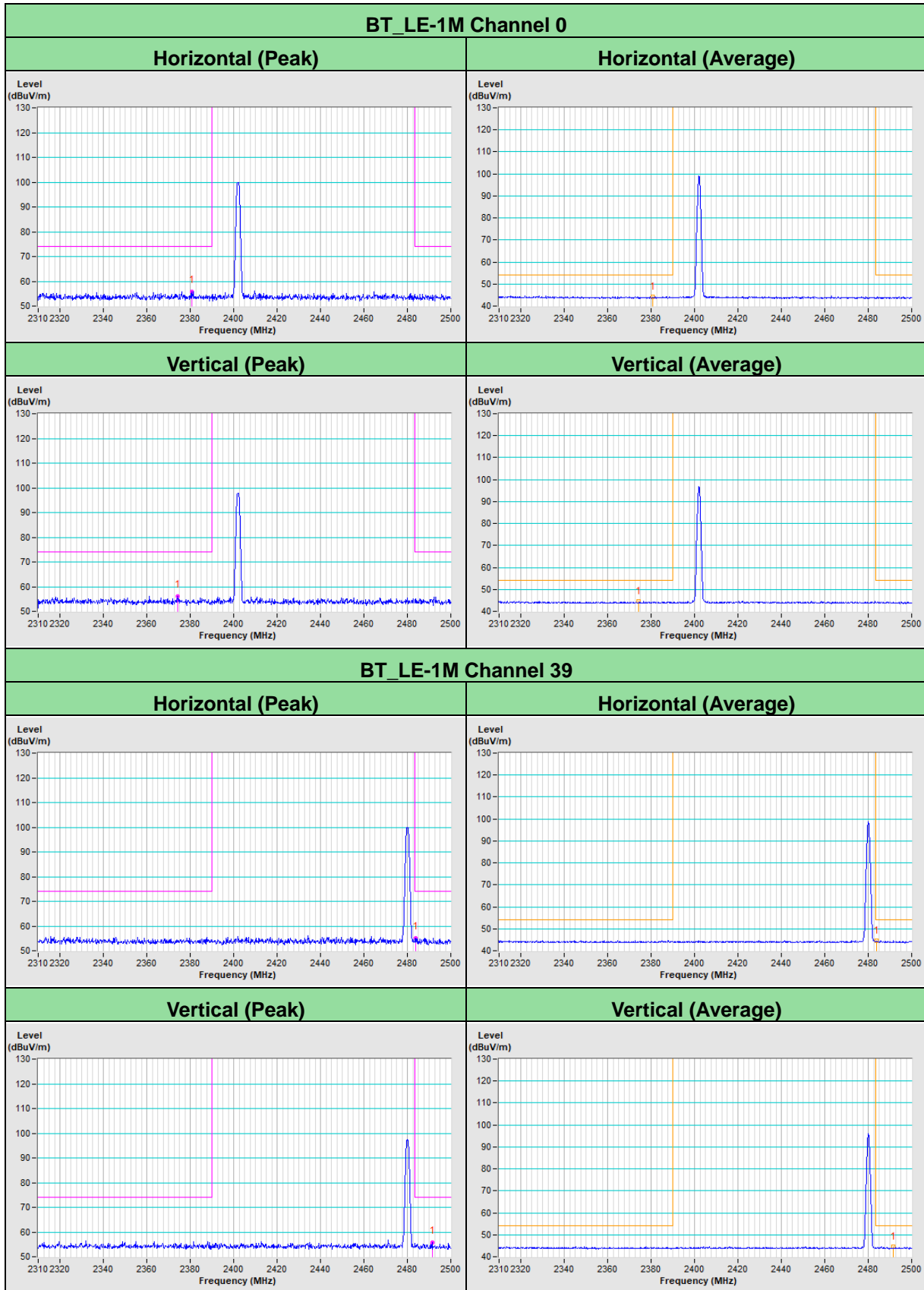

BT-LE 2M

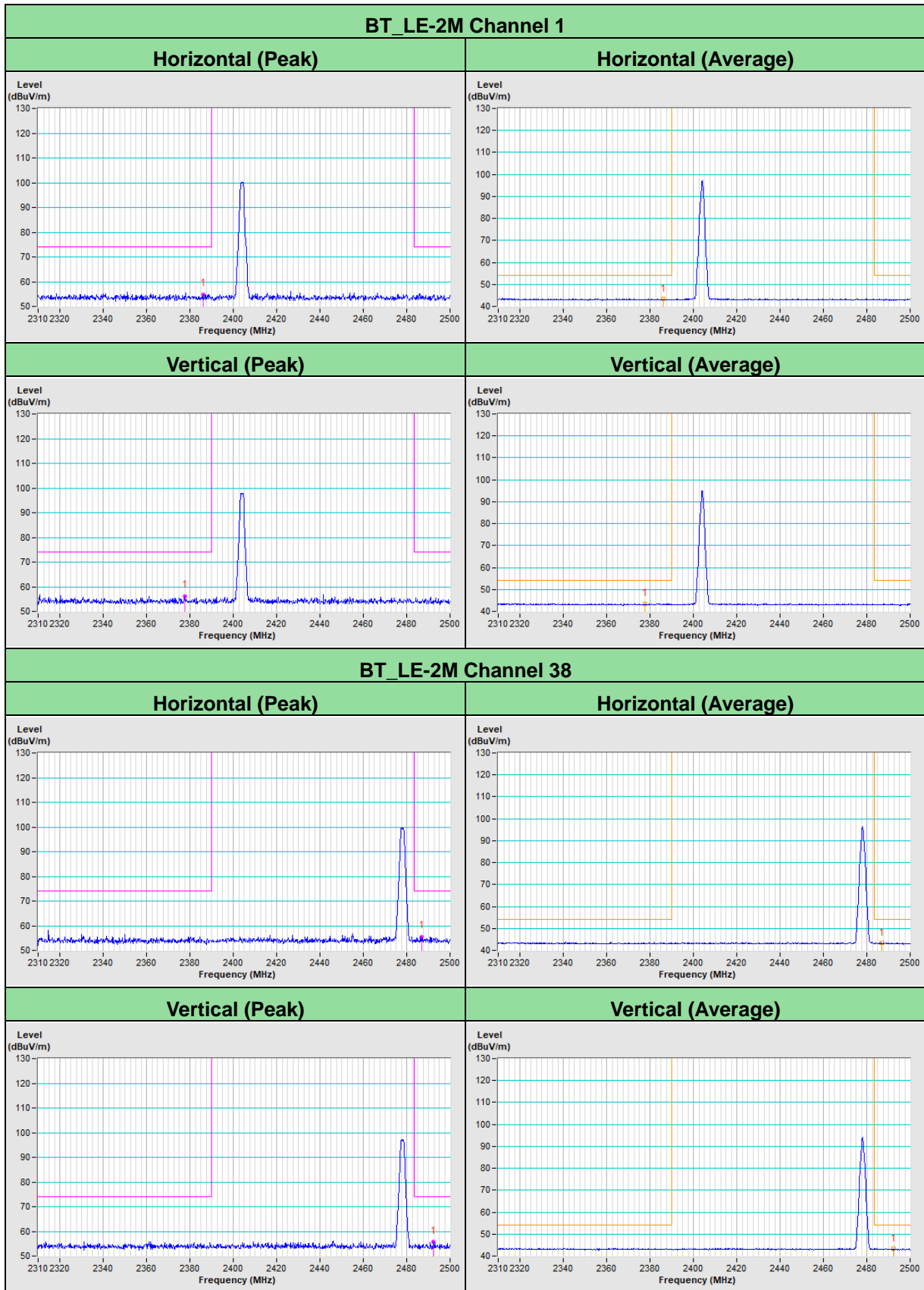

Annex A.2 - Test Results (Mode 2)

Dipole Antenna

BT-LE 1M

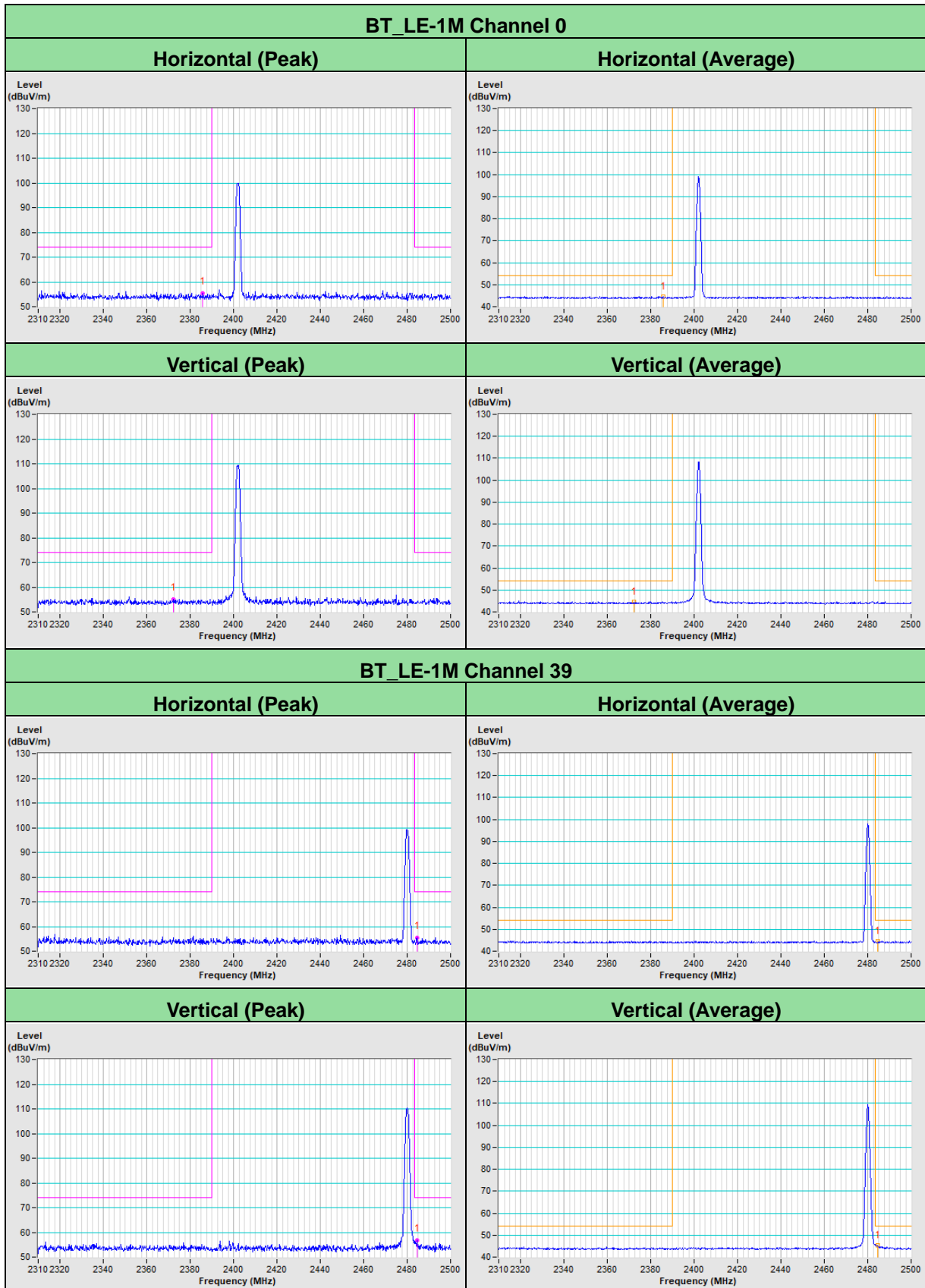

BT-LE 2M

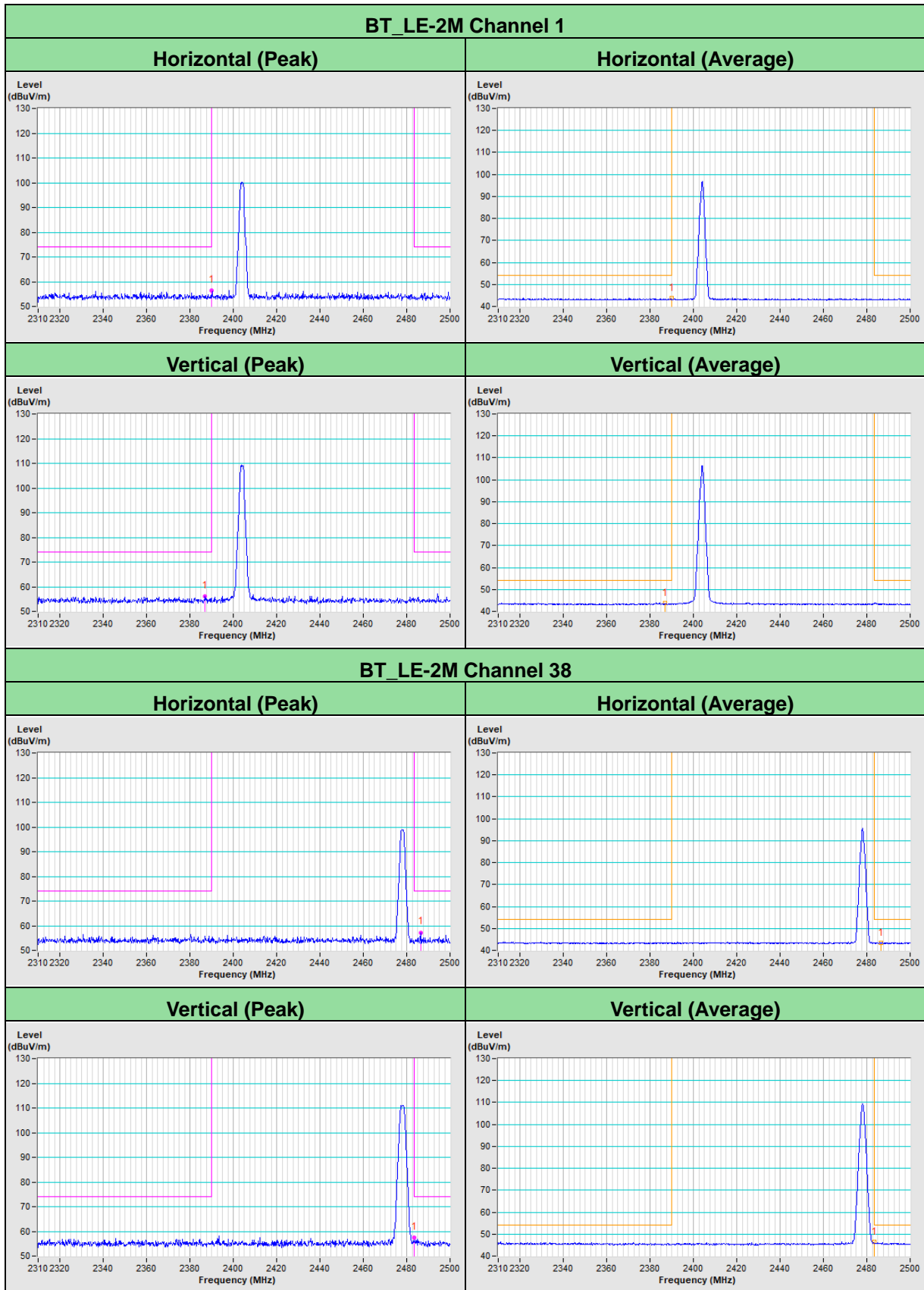

PIFA Antenna

BT-LE 1M

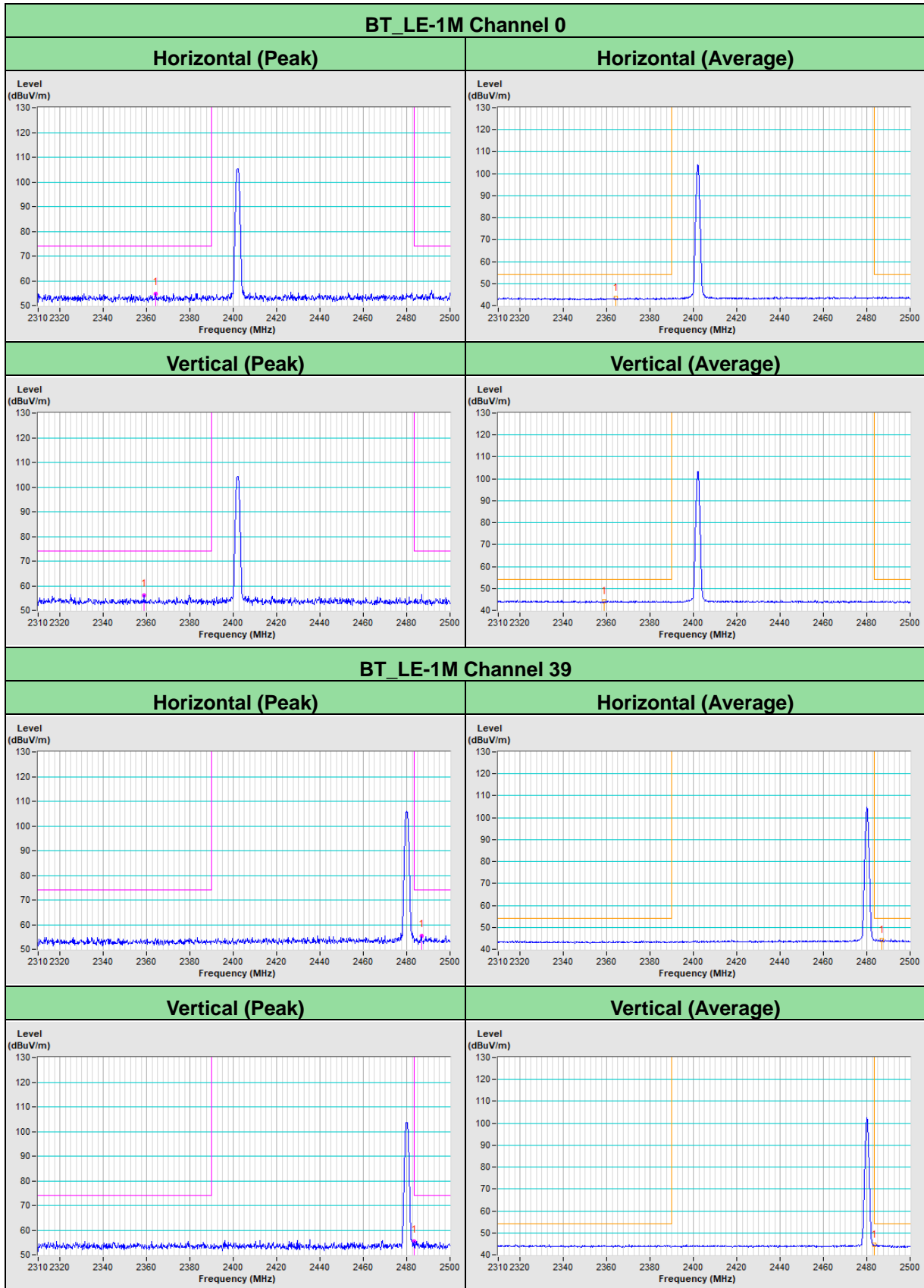

BT-LE 2M

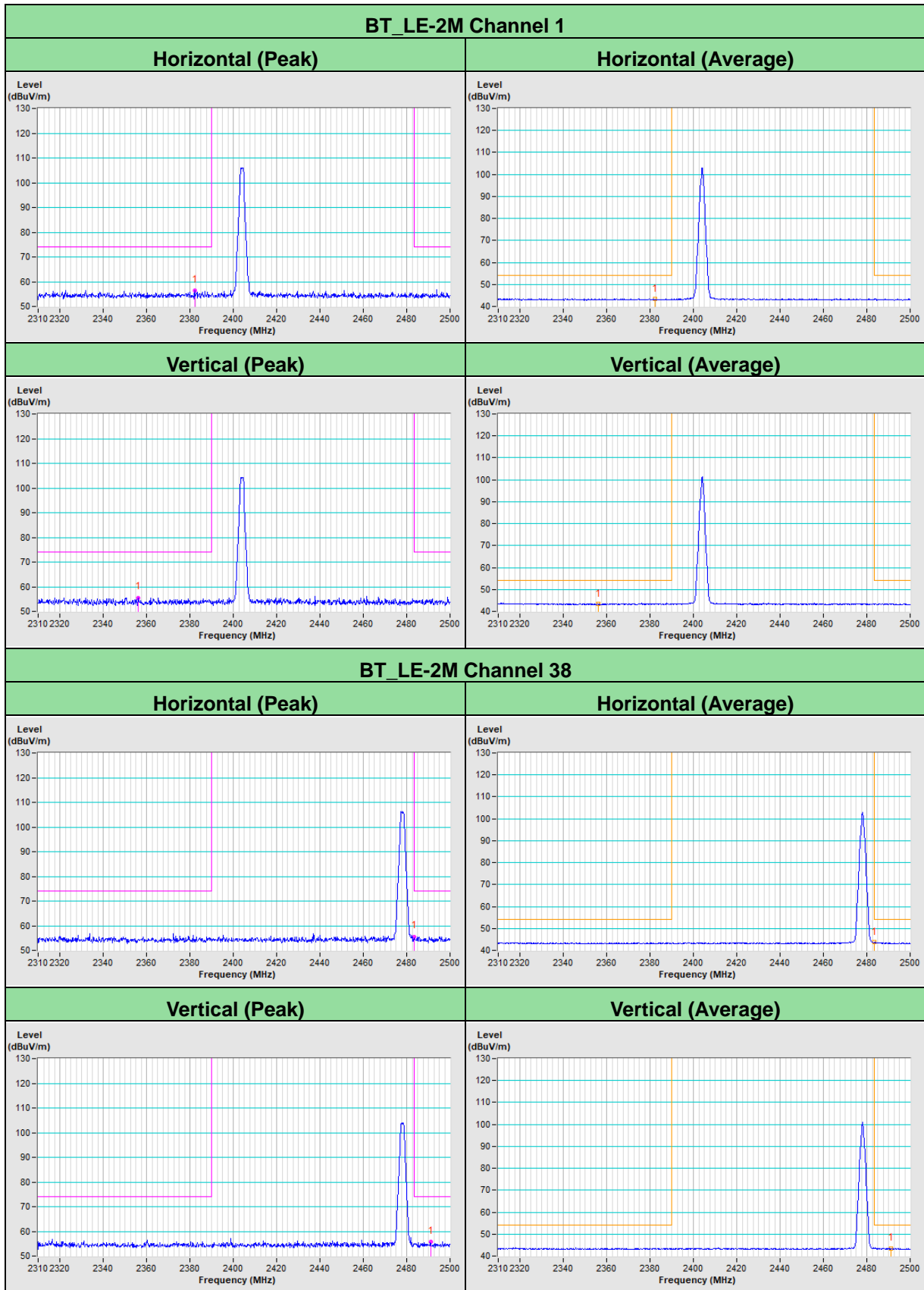

Appendix – Information of the Testing Laboratories

We, Bureau Veritas Consumer Products Services (H.K.) Ltd., Taoyuan Branch, were founded in 1988 to provide our best service in EMC, Radio, Telecom and Safety consultation. Our laboratories are FCC recognized accredited test firms and accredited according to ISO/IEC 17025.

If you have any comments, please feel free to contact us at the following:

Lin Kou EMC/RF Lab

Tel: 886-2-26052180

Fax: 886-2-26051924

Hsin Chu EMC/RF/Telecom Lab

Tel: 886-3-6668565

Fax: 886-3-6668323

Hwa Ya EMC/RF/Safety Lab

Tel: 886-3-3183232

Fax: 886-3-3270892

Email: service.adt@tw.bureauveritas.com

Web Site: www.bureauveritas-adt.com

The address and road map of all our labs can be found in our web site also.

--- END ---