

# TEST REPORT

Report No.: BCTC2304709645-4E

---

Applicant: ROCKPI TRADING LIMITED

---

Product Name: Radxa ROCK 3 Model C

---

Model/Type reference: Radxa ROCK 3 Model C

---

Tested Date: 2023-04-07 to 2023-05-17

---

Issued Date: 2023-05-26

---

**Shenzhen BCTC Testing Co., Ltd.**



Product Name: Radxa ROCK 3 Model C  
Trademark: N/A  
Model/Type reference: Radxa ROCK 3 Model C  
Radxa ROCK 3 Model C 1GB, Radxa ROCK 3 Model C 2GB,  
Radxa ROCK 3 Model C 4GB, Radxa ROCK 3 Model C 8GB  
Prepared For: ROCKPI TRADING LIMITED  
Address: Room 11, 27 / f, Ga wah international centre, 191 Javaroad, north point, Hong Kong  
Manufacturer: ROCKPI TRADING LIMITED  
Address: Room 11, 27 / f, Ga wah international centre, 191 Javaroad, north point, Hong Kong  
Prepared By: Shenzhen BCTC Testing Co., Ltd.  
Address: 1-2/F., Building B, Pengzhou Industrial Park, No.158, Fuyuan 1st Road, Zhancheng,  
Fuhai Subdistrict, Bao'an District, Shenzhen, Guangdong, China  
Sample Received Date: 2023-04-07  
Sample tested Date: 2023-04-07 to 2023-05-17  
Issue Date: 2023-05-26  
Report No.: BCTC2304709645-4E  
Test Standards: ETSI EN 300 328 V2.2.2 (2019-07)  
Test Results: PASS

Tested by:

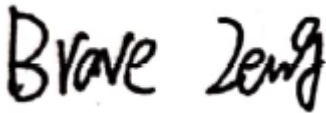

Brave Zeng/ Project Handler

Approved by:



Zero Zhou/Reviewer

The test report is effective only with both signature and specialized stamp. This result(s) shown in this report refer only to the sample(s) tested. Without written approval of Shenzhen BCTC Testing Co., Ltd, this report can't be reproduced except in full. The tested sample(s) and the sample information are provided by the client.



## Table Of Content

Test Report Declaration	Page
1. Version .....	5
2. Test Summary .....	6
3. Measurement Uncertainty .....	7
4. Product Information And Test Setup .....	8
4.1 Product Information.....	8
4.2 Test Setup Configuration .....	8
4.3 Support Equipment .....	8
4.4 Channel List.....	9
4.5 Test Mode .....	9
4.6 Test Environment.....	9
5. Test Facility And Test Instrument Used.....	10
5.1 Test Facility.....	10
5.2 Test Instrument Used.....	10
6. Information As Required.....	11
7. RF Output Power.....	14
7.1 Block Diagram Of Test Setup.....	14
7.2 Limit .....	14
7.3 Test Procedure .....	14
7.4 Test Result.....	16
8. Power Spectral Density .....	20
8.1 Block Diagram Of Test Setup.....	20
8.2 Limit .....	20
8.3 Test Procedure .....	20
8.4 Test Result.....	21
9. Adaptivity.....	25
9.1 Block Diagram Of Test Setup.....	25
9.2 Limit .....	25
9.3 Test Procedure .....	26
9.4 Test Result.....	27
10. Occupied Channel Bandwidth .....	28
10.1 Block Diagram Of Test Setup.....	28
10.2 Limit .....	28
10.3 Test Procedure .....	28
10.4 Test Result.....	29
11. Transmitter Unwanted Emissions In The Out-Of-Band Domain .....	32
11.1 Block Diagram Of Test Setup.....	32
11.2 Limit .....	32
11.3 Test Procedure .....	32
11.4 Test Result.....	34
12. Transmitter Unwanted Emissions In The Spurious Domain .....	37
12.1 Block Diagram Of Test Setup.....	37
12.2 Limits.....	38
12.3 Test Procedure .....	38

BCTC  
 3C  
 PPR  
 检测

12.4	Test Results .....	39
13.	Receiver Spurious Emissions.....	40
13.1	Block Diagram Of Test Setup.....	40
13.2	Limits.....	40
13.3	Test Procedure .....	41
13.4	Test Results .....	42
14.	Receiver Blocking.....	43
14.1	Block Diagram Of Test Setup.....	43
14.2	Limit .....	43
14.3	Test Procedure .....	44
14.4	Test Result.....	44
15.	EUT Photographs.....	45
16.	EUT Test Setup Photographs.....	49

(Note: N/A Means Not Applicable)

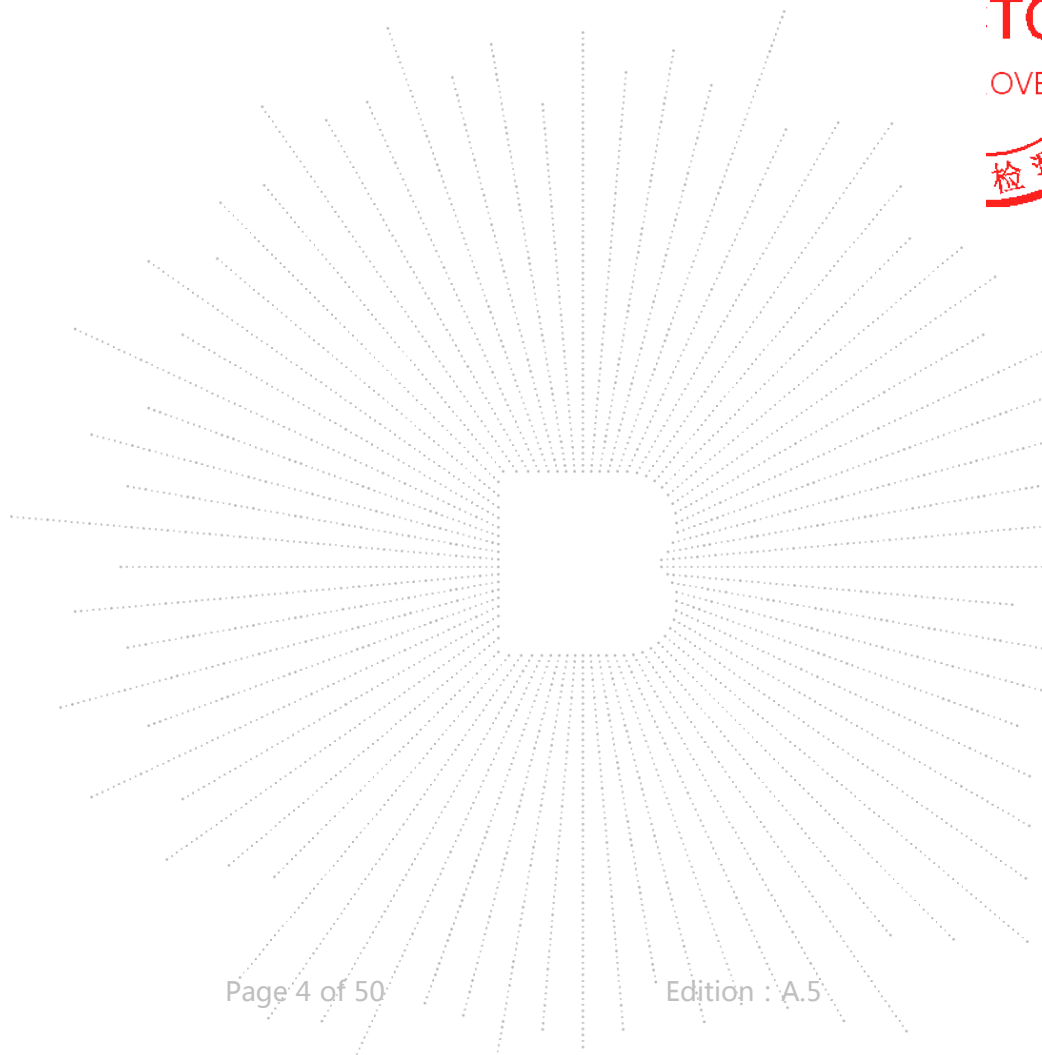

**1. Version**

Report No.	Issue Date	Description	Approved
BCTC2304709645-4E	2023-05-26	Original	Valid

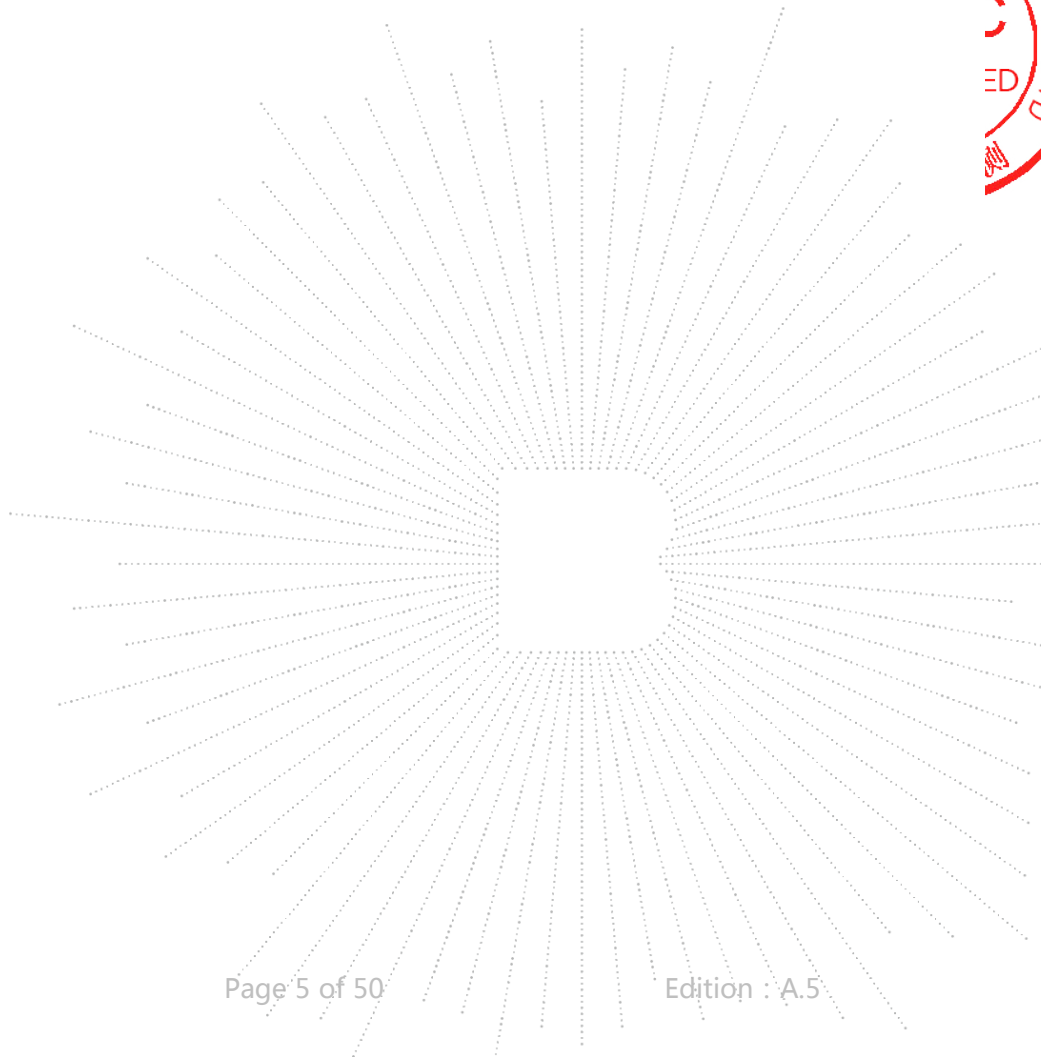

## 2. Test Summary

The Product has been tested according to the following specifications:

No.	Test Parameter	Clause No	Results
Transmitter Parameters			
1	RF output power	4.3.2.2	PASS
2	Power Spectral Density	4.3.2.3	PASS
3	Duty Cycle, TX-sequence, TX-gap	4.3.2.4	N/A
4	Medium Utilization (MU) factor	4.3.2.5	N/A
5	Adaptivity (adaptive equipment using modulations other than FHSS)	4.3.2.6	N/A
6	Occupied Channel Bandwidth	4.3.2.7	PASS
7	Transmitter unwanted emissions in the out-of-band domain	4.3.2.8	PASS
8	Transmitter unwanted emissions in the spurious domain	4.3.2.9	PASS
Receiver Parameters			
9	Receiver spurious emissions	4.3.2.10	PASS
10	Receiver Blocking	4.3.2.11	PASS
11	Geo-location Capability	4.3.2.12	N/A
Note: N/A is an abbreviation for Not Applicable and means this test item is not applicable for this device according to the technology characteristic of device.			

CO., LTD

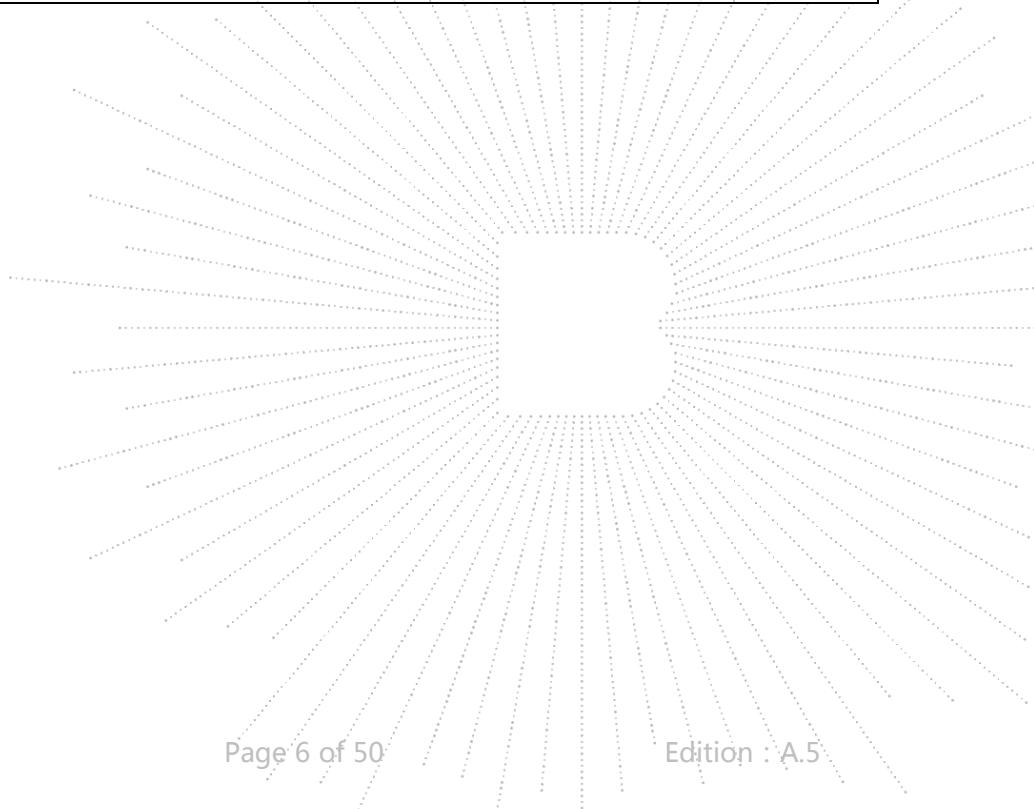

### 3. Measurement Uncertainty

Where relevant, the following measurement uncertainty levels have been estimated for tests performed on the Product as specified in CISPR 16-4-2. This uncertainty represents an expanded uncertainty expressed at approximately the 95% confidence level using a coverage factor of k=2.

Test item	uncertainty
RF frequency	1 x 10 <sup>-7</sup>
RF power, conducted	1.38dB
Conducted spurious emission (30MHz-1GHz)	1.28dB
Conducted spurious emission (1GHz-18GHz)	1.576dB
Radiated Spurious emission (30MHz-1GHz)	4.3dB
Radiated Spurious emission (1GHz-18GHz)	4.5dB
Temperature	0.59°C
Humidity	5.3%

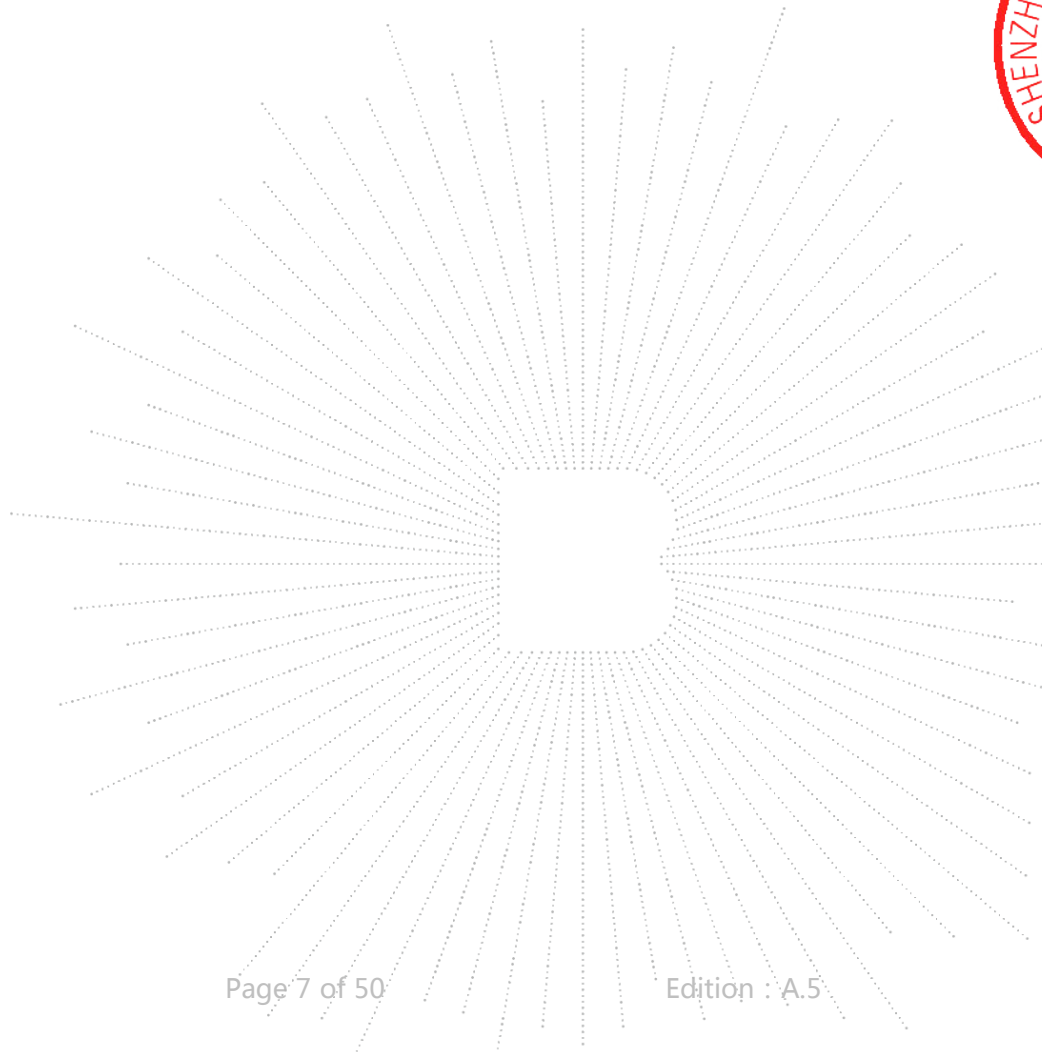

## 4. Product Information And Test Setup

### 4.1 Product Information

Model/Type reference:	Radxa ROCK 3 Model C Radxa ROCK 3 Model C 1GB, Radxa ROCK 3 Model C 2GB, Radxa ROCK 3 Model C 4GB, Radxa ROCK 3 Model C 8GB
Model differences:	All the model are the same circuit and RF module, except model names.
Bluetooth Version:	5.0
Hardware Version:	V1.32
Software Version:	V1.0
Operation Frequency:	Bluetooth(BLE): 2402-2480MHz
Max. RF output power:	Bluetooth(BLE): 2.95 dBm
Type of Modulation:	Bluetooth(BLE):GFSK
Antenna installation:	Bluetooth(BLE):Internal antenna
Antenna Gain:	Bluetooth(BLE): 1.5 dBi
Ratings:	DC 5V from adapter

Cable of Product

No.	Cable Type	Quantity	Provider	Length (m)	Shielded	Note
1	--	--	Applicant	---	Yes/No	With a ferrite ring in mid Detachable
2	--	--	BCTC	--	Yes/No	--

### 4.2 Test Setup Configuration

See test photographs attached in EUT TEST SETUP PHOTOGRAPHS for the actual connections between Product and support equipment.

### 4.3 Support Equipment

No.	Device Type	Brand	Model	Series No.	Note
1.	Adapter	---	BCTC001	---	auxiliary

**Notes:**

- All the equipment/cables were placed in the worst-case configuration to maximize the emission during the test.
- Grounding was established in accordance with the manufacturer's requirements and conditions for the intended use.



#### 4.4 Channel List

CH No.	Frequency (MHz)	CH No.	Frequency (MHz)	CH No.	Frequency (MHz)	CH No.	Frequency (MHz)
0	2402	1	2404	2	2406	3	2408
4	2410	5	2412	6	2414	7	2416
8	2418	9	2420	10	2422	11	2424
12	2426	13	2428	14	2430	15	2432
16	2434	17	2436	18	2438	19	2440
20	2442	21	2444	22	2446	23	2448
24	2450	25	2452	26	2454	27	2456
28	2458	29	2460	30	2462	31	2464
32	2466	33	2468	34	2470	35	2472
36	2474	37	2476	38	2478	39	2480

#### 4.5 Test Mode

All test mode(s) and condition(s) mentioned were considered and evaluated respectively by performing full tests, the worst data were recorded and reported.

Test mode	Low channel	Middle channel	High channel
Transmitting(GFSK 1Mbps)	2402MHz	2440MHz	2480MHz
Transmitting(GFSK 2Mbps)	2402MHz	2440MHz	2480MHz
Receiving(GFSK 1Mbps)	2402MHz	2440MHz	2480MHz
Receiving(GFSK 2Mbps)	2402MHz	2440MHz	2480MHz

#### 4.6 Test Environment

##### 1. Normal Test Conditions:

Humidity(%):	54
Atmospheric Pressure(kPa):	101
Temperature(°C):	26
Test Voltage(DC):	5V

##### 2. Extreme Test Conditions:

For tests at extreme temperatures, measurements shall be made over the extremes of the operating temperature range as declared by the manufacturer.

For tests at extreme voltages, measurements shall be made over the extremes of the power source voltage range as declared by the manufacturer.

Test Conditions	LT	HT
Temperature (°C)	0	35

TC  
 BC  
 PPR  
 检测

## 5. Test Facility And Test Instrument Used

### 5.1 Test Facility

All measurement facilities used to collect the measurement data are located at Shenzhen BCTC Testing Co., Ltd. Address:1-2/F., Building B, Pengzhou Industrial Park, No.158, Fuyuan 1st Road, Zhancheng, Fuhai Subdistrict, Bao'an District, Shenzhen, Guangdong, China. The site and apparatus are constructed in conformance with the requirements of ANSI C63.4 and CISPR 16-1-1 other equivalent standards.

### 5.2 Test Instrument Used

Item	Equipment	Manufacturer	Type No.	Serial No.	Last calibration	Calibrated until
1	966 chamber	SKET	966 Room	966	Nov. 02. 2021	Nov. 01.2024
2	Receiver	R&S	ESR3	102075	May 24, 2022	May 23, 2023
3	Receiver	R&S	ESR17	100010	Nov. 08. 2022	Nov. 07.2023
4	Amplifier	SKET	LNPA-30M01 G-30	SK2021082004	Nov. 08. 2022	Nov. 07.2023
5	TRILOG Broadband Antenna	Schwarzbeck	VULB9168	1323	Mar. 06, 2022	Mar. 05, 2024
6	Loop Antenna	Schwarzbeck	FMZB1519B	00014	Jun. 06, 2022	Jun. 05, 2023
7	Amplifier	SKET	LAPA_01G18 G-45dB	\	May 24, 2022	May 23, 2023
8	Horn Antenna	Schwarzbeck	BBHA9120D	1541	Jun. 06, 2022	Jun. 05, 2023
9	Preamplifier	MITEQ	TTA1840-35- HG	2034381	May 24, 2022	May 23, 2023
10	Horn antenna	Schwarzbeck	BBHA9170	00822	Jun. 06, 2022	Jun. 05, 2023
11	Spectrum Analyzer 9kHz-40GHz	R&S	FSP 40	100363	May 24, 2022	May 23, 2023
12	Software	Frad	EZ-EMC	FA-03A2 RE	\	\
13	Spectrum Analyzer	Keysight	N9020A	MY49100060	May 24, 2022	May 23, 2023
14	Signal Generator	Keysight	N5182B	MY56200519	May 24, 2022	May 23, 2023
15	Signal Generator	Keysight	83711B	US37100131	Aug. 29, 2022	Aug. 28, 2023
16	Communication test set	R&S	CMW500	126173	Nov. 08, 2022	Nov. 07, 2023
17	D.C. Power Supply	LongWei	TPR-6405D	\	\	\
18	Programmable constant temperature and humidity test chamber	DGBELL	BTKS5-150C	\	Jun. 30, 2022	Jun. 29, 2023
19	Radio frequency control box	MAIWEI	MW100-RFC B	\	\	\
20	Software	MAIWEI	MTS 8310	\	\	\

## 6. Information As Required

### ETSI EN 300 328 V2.2.2 Annex E

<b>a) The type of modulation used by the equipment:</b>
<input type="checkbox"/> FHSS
<input checked="" type="checkbox"/> non-FHSS
<b>b) In case of FHSS modulation:</b>
<input type="checkbox"/> In case of non-Adaptive Frequency Hopping equipment: The number of Hopping Frequencies: _
<input type="checkbox"/> In case of Adaptive Frequency Hopping Equipment: The maximum number of Hopping Frequencies: _ The minimum number of Hopping Frequencies: _
<input type="checkbox"/> The (average) Dwell Time: _____ maximum
<b>c) Adaptive / non-adaptive equipment:</b>
<input type="checkbox"/> non-adaptive Equipment
<input checked="" type="checkbox"/> adaptive Equipment without the possibility to switch to a non-adaptive mode
<input type="checkbox"/> adaptive Equipment which can also operate in a non-adaptive mode
<b>d) In case of adaptive equipment:</b>
The maximum Channel Occupancy Time implemented by the equipment: _
<input type="checkbox"/> The equipment has implemented an LBT mechanism
<input type="checkbox"/> In case of non-FHSS equipment:
<input type="checkbox"/> The equipment is Frame Based equipment
<input checked="" type="checkbox"/> The equipment is Load Based equipment
<input type="checkbox"/> The equipment can switch dynamically between Frame Based and Load Based equipment
The CCA time implemented by the equipment: ..... $\mu$ s
<input type="checkbox"/> The equipment has implemented a DAA mechanism
<input type="checkbox"/> The equipment can operate in more than one adaptive mode
<b>e) In case of non-adaptive Equipment:</b>
The maximum RF Output Power (e.i.r.p.):
The maximum (corresponding) Duty Cycle:
Equipment with dynamic behaviour, that behaviour is described here. (e.g. the different combinations of duty cycle and corresponding power levels to be declared): .....
<b>f) The worst case operational mode for each of the following tests:</b>
<input checked="" type="checkbox"/> RF Output Power: GFSK
<input checked="" type="checkbox"/> Power Spectral Density: GFSK
<input type="checkbox"/> Duty cycle, Tx-Sequence, Tx-gap
<input type="checkbox"/> Accumulated Transmit time, Frequency Occupation & Hopping Sequence (only for FHSS equipment):
<input type="checkbox"/> Hopping Frequency Separation (only for FHSS equipment):
<input type="checkbox"/> Medium Utilization:
<input checked="" type="checkbox"/> Adaptivity & Receiver Blocking: GFSK
<input checked="" type="checkbox"/> Nominal Channel Bandwidth: GFSK
<input checked="" type="checkbox"/> Transmitter unwanted emissions in the OOB domain: GFSK
<input checked="" type="checkbox"/> Transmitter unwanted emissions in the spurious domain: GFSK
<input checked="" type="checkbox"/> Receiver spurious emissions : GFSK
<b>g) The different transmit operating modes (tick all that apply):</b>
<input checked="" type="checkbox"/> Operating mode 1: Single Antenna Equipment
<input checked="" type="checkbox"/> Equipment with only one antenna
<input type="checkbox"/> Equipment with two diversity antennas but only one antenna active at any moment in time
<input type="checkbox"/> Smart Antenna Systems with two or more antennas, but operating in a (legacy) mode where only One antenna is used (e.g. IEEE 802.11™ [i.3] legacy mode in smart antenna systems)
<input type="checkbox"/> Operating mode 2: Smart Antenna Systems - Multiple Antennas without beam forming
<input type="checkbox"/> Single spatial stream / Standard throughput / (e.g. IEEE 802.11™ [i.3] legacy mode)



<input type="checkbox"/> High Throughput (> 1 spatial stream) using Nominal Channel Bandwidth 1																
<input type="checkbox"/> High Throughput (> 1 spatial stream) using Nominal Channel Bandwidth 2																
NOTE 1: Add more lines if more channel bandwidths are supported.																
<input type="checkbox"/> Operating mode 3: Smart Antenna Systems - Multiple Antennas with beam forming																
<input type="checkbox"/> Single spatial stream / Standard throughput (e.g. IEEE 802.11™ [i.3] legacy mode)																
<input type="checkbox"/> High Throughput (> 1 spatial stream) using Nominal Channel Bandwidth 1																
<input type="checkbox"/> High Throughput (> 1 spatial stream) using Nominal Channel Bandwidth 2																
NOTE 2: Add more lines if more channel bandwidths are supported.																
<b>h) In case of Smart Antenna Systems:</b>																
The number of Receive chains:																
The number of Transmit chains:																
<input type="checkbox"/> symmetrical power distribution																
<input type="checkbox"/> asymmetrical power distribution																
In case of beam forming, the maximum (additional) beam forming gain:																
NOTE: The additional beam forming gain does not include the basic gain of a single antenna.																
<b>i) Operating Frequency Range(s) of the equipment:</b>																
Operating Frequency Range 1: Refer to section 4.1																
Operating Frequency Range 2: _																
NOTE: Add more lines if more Frequency Ranges are supported.																
<b>j) Nominal Channel Bandwidth(s):</b>																
Nominal Channel Bandwidth 1: <u>2.207 MHz Max.</u>																
NOTE: Add more lines if more channel bandwidths are supported.																
<b>k) Type of Equipment (stand-alone, combined, plug-in radio device, etc.):</b>																
<input checked="" type="checkbox"/> Stand-alone																
<input type="checkbox"/> Combined Equipment																
<input type="checkbox"/> Plug-in radio device																
<input type="checkbox"/> Other																
<b>l) The normal and the extreme operating conditions that apply to the equipment:</b>																
Refer to section 4.6																
<b>m) The intended combination(s) of the radio equipment power settings and one or more antenna assemblies and their corresponding e.i.r.p. levels:</b>																
Antenna Type:																
<input checked="" type="checkbox"/> Internal antenna																
Antenna Gain: Refer to section 4.1																
If applicable, additional beamforming gain (excluding basic antenna gain):																
<input type="checkbox"/> Temporary RF connector provided																
<input type="checkbox"/> No temporary RF connector provided																
<input type="checkbox"/> Dedicated Antennas (equipment with antenna connector)																
<input type="checkbox"/> Single power level with corresponding antenna(s)																
<input type="checkbox"/> Multiple power settings and corresponding antenna(s)																
Number of different Power Levels:																
Power Level 1:																
Power Level 2:																
Power Level 3:																
NOTE 1: Add more lines in case the equipment has more power levels.																
NOTE 2: These power levels are conducted power levels (at antenna connector).																
For each of the Power Levels, provide the intended antenna assemblies, their corresponding gains (G) and the resulting e.i.r.p. levels also taking into account the beamforming gain (Y) if applicable																
<b>Power Level 1:</b>																
Number of antenna assemblies provided for this power level:																
<table border="1" style="width: 100%; border-collapse: collapse; margin-top: 20px;"> <thead> <tr> <th style="width: 15%;">Assembly #</th> <th style="width: 20%;">Gain (dBi)</th> <th style="width: 20%;">e.i.r.p.(dBm)</th> <th style="width: 45%;">Part number or model name</th> </tr> </thead> <tbody> <tr> <td style="text-align: center;">1</td> <td></td> <td></td> <td></td> </tr> <tr> <td style="text-align: center;">2</td> <td></td> <td></td> <td></td> </tr> <tr> <td style="text-align: center;">3</td> <td></td> <td></td> <td></td> </tr> </tbody> </table>	Assembly #	Gain (dBi)	e.i.r.p.(dBm)	Part number or model name	1				2				3			
Assembly #	Gain (dBi)	e.i.r.p.(dBm)	Part number or model name													
1																
2																
3																

e CO. LTD

4																							
NOTE 3: Add more rows in case more antenna assemblies are supported for this power level.																							
<b>Power Level 2:</b>																							
Number of antenna assemblies provided for this power level:																							
<table border="1" style="width: 100%; border-collapse: collapse;"> <thead> <tr> <th style="width: 25%;">Assembly #</th> <th style="width: 25%;">Gain (dBi)</th> <th style="width: 25%;">e.i.r.p.(dBm)</th> <th style="width: 25%;">Part number or model name</th> </tr> </thead> <tbody> <tr><td style="text-align: center;">1</td><td></td><td></td><td></td></tr> <tr><td style="text-align: center;">2</td><td></td><td></td><td></td></tr> <tr><td style="text-align: center;">3</td><td></td><td></td><td></td></tr> <tr><td style="text-align: center;">4</td><td></td><td></td><td></td></tr> </tbody> </table>				Assembly #	Gain (dBi)	e.i.r.p.(dBm)	Part number or model name	1				2				3				4			
Assembly #	Gain (dBi)	e.i.r.p.(dBm)	Part number or model name																				
1																							
2																							
3																							
4																							
NOTE 4: Add more rows in case more antenna assemblies are supported for this power level.																							
<b>Power Level 3:</b>																							
Number of antenna assemblies provided for this power level:																							
<table border="1" style="width: 100%; border-collapse: collapse;"> <thead> <tr> <th style="width: 25%;">Assembly #</th> <th style="width: 25%;">Gain (dBi)</th> <th style="width: 25%;">e.i.r.p.(dBm)</th> <th style="width: 25%;">Part number or model name</th> </tr> </thead> <tbody> <tr><td style="text-align: center;">1</td><td></td><td></td><td></td></tr> <tr><td style="text-align: center;">2</td><td></td><td></td><td></td></tr> <tr><td style="text-align: center;">3</td><td></td><td></td><td></td></tr> <tr><td style="text-align: center;">4</td><td></td><td></td><td></td></tr> </tbody> </table>				Assembly #	Gain (dBi)	e.i.r.p.(dBm)	Part number or model name	1				2				3				4			
Assembly #	Gain (dBi)	e.i.r.p.(dBm)	Part number or model name																				
1																							
2																							
3																							
4																							
NOTE 5: Add more rows in case more antenna assemblies are supported for this power level.																							
<b>n) The nominal voltages of the stand-alone radio equipment or the nominal voltages of the combined (host) equipment or test jig in case of plug-in devices:</b>																							
Refer to section 4.																							
<b>o) Describe the test modes available which can facilitate testing:</b>																							
.....																							
<b>p) The equipment type (e.g. Bluetooth®, IEEE 802.11™ [i.3], IEEE 802.15.4™ [i.4], proprietary, etc.):</b> .....																							
<b>q) If applicable, the statistical analysis referred to in clause 5.4.1 q)</b>																							
(to be provided as separate attachment)																							
<b>r) If applicable, the statistical analysis referred to in clause 5.4.1 r)</b>																							
(to be provided as separate attachment)																							
<b>s) Geo-location capability supported by the equipment:</b>																							
<input type="checkbox"/> Yes																							
<input type="checkbox"/> The geographical location determined by the equipment as defined in clause 4.3.1.13.2 or clause 4.3.2.12.2 is not accessible to the user																							
<input checked="" type="checkbox"/> No																							



## 7. RF Output Power

### 7.1 Block Diagram Of Test Setup

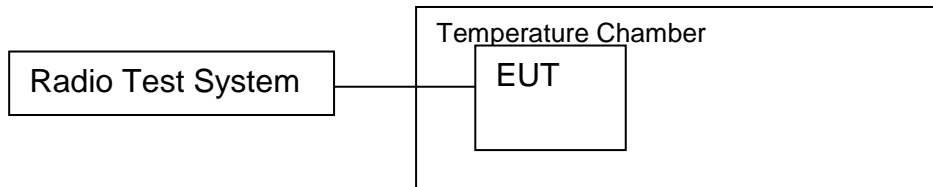

### 7.2 Limit

The RF output power for non-FHSS equipment shall be equal to or less than 20 dBm..

NOTE: For Non-adaptive FHSS equipment, the manufacturer may have declared a reduced RF Output Power (see clause 5.4.1 m) and associated Duty Cycle (see clause 5.4.1 e)) that will ensure that the equipment meets the requirement for the Medium Utilization (MU) factor further described in clause 4.3.2.5. This is verified by the conformance test referred to in clause 4.3.2.5.4.)

For non-adaptive non-FHSS equipment, where the manufacturer has declared an RF output power of less than 20 dBm e.i.r.p., the RF output power shall be equal to or less than that declared value. This limit shall apply for any combination of power level and intended antenna assembly

Limit
20dBm

### 7.3 Test Procedure

#### Step 1:

- Use a fast power sensor with a minimum sensitivity of -40 dBm and capable of minimum 1 MS/s..
  - Use the following settings:
    - Sample speed 1 MS/s or faster.
    - The samples shall represent the RMS power of the signal.
    - Measurement duration: For non-adaptive equipment: equal to the observation period defined in clause 4.3.1.3.2 or clause 4.3.2.4.2. For adaptive equipment, the measurement duration shall be long enough to ensure a minimum number of bursts (at least 10) are captured.
- NOTE 1: For adaptive equipment, to increase the measurement accuracy, a higher number of bursts may be used.

#### Step 2:

- For conducted measurements on devices with one transmit chain:
  - Connect the power sensor to the transmit port, sample the transmit signal and store the raw data. Use these stored samples in all following steps.
- For conducted measurements on devices with multiple transmit chains:
  - Connect one power sensor to each transmit port for a synchronous measurement on all transmit ports.
  - Trigger the power sensors so that they start sampling at the same time. Make sure the time difference between the samples of all sensors is less than 500 ns.
  - For each individual sampling point (time domain), sum the coincident power samples of all ports and store them. Use these summed samples as the new stored data set..





**Step 3:**

- Find the start and stop times of each burst in the stored measurement samples.  
The start and stop times are defined as the points where the power is at least 30 dB below the highest value of the stored samples in step 2.  
In case of insufficient sensitivity of the power sensor (e.g. in case of radiated measurements), the value of 30 dB may need to be reduced appropriately.

**Step 4:**

- Between the start and stop times of each individual burst calculate the RMS power over the burst using the formula below. The start and stop points shall be included. Save these Pburst values, as well as the start and stop times for each burst.

$$P_{burst} = \frac{1}{k} \sum_{n=1}^k P_{sample}(n)$$

with 'k' being the total number of samples and 'n' the actual sample number

**Step 5:**

- The highest of all Pburst values (value "A" in dBm) will be used for maximum e.i.r.p. calculations.

**Step 6:**

- Add the (stated) antenna assembly gain "G" in dBi of the individual antenna.
  - In case of smart antenna systems operating in mode with beamforming (see clause 5.3.2.2.4), add the additional beamforming gain Y in dB.
  - If more than one antenna assembly is intended for this power setting, the maximum overall antenna gain (G or G + Y) shall be used.
- The RF Output Power (Pout) shall be calculated using the formula below:  
$$P_{out} = A + G + Y$$
- This value, which shall comply with the limit given in clause 4.3.1.2.3 or clause 4.3.2.2.3, shall be recorded in the test report..

TC  
3C  
PPR  
測

## 7.4 Test Result

Condition	Mode	Frequency (MHz)	Max Burst RMS Power (dBm)	Burst Number	Max EIRP (dBm)	Limit (dBm)	Verdict
NVNT	BLE 1M	2402	-2.19	161	-0.69	20	Pass
	BLE 1M	2440	0.43	161	1.93	20	Pass
	BLE 1M	2480	1.45	160	<b>2.95</b>	20	Pass
NVLT	BLE 1M	2402	-2.38	161	-0.88	20	Pass
	BLE 1M	2440	0.33	161	1.83	20	Pass
	BLE 1M	2480	1.27	161	2.77	20	Pass
NVHT	BLE 1M	2402	-2.37	160	-0.87	20	Pass
	BLE 1M	2440	0.35	160	1.85	20	Pass
	BLE 1M	2480	1.28	160	2.78	20	Pass
NVNT	BLE 2M	2402	-2.09	54	-0.59	20	Pass
	BLE 2M	2440	0.27	54	1.77	20	Pass
	BLE 2M	2480	1.13	54	2.63	20	Pass
NVLT	BLE 2M	2402	-2.13	54	-0.63	20	Pass
	BLE 2M	2440	0.05	54	1.55	20	Pass
	BLE 2M	2480	0.18	54	1.68	20	Pass
NVHT	BLE 2M	2402	-2.35	54	-0.85	20	Pass
	BLE 2M	2440	0.04	54	1.54	20	Pass
	BLE 2M	2480	-0.63	54	0.87	20	Pass

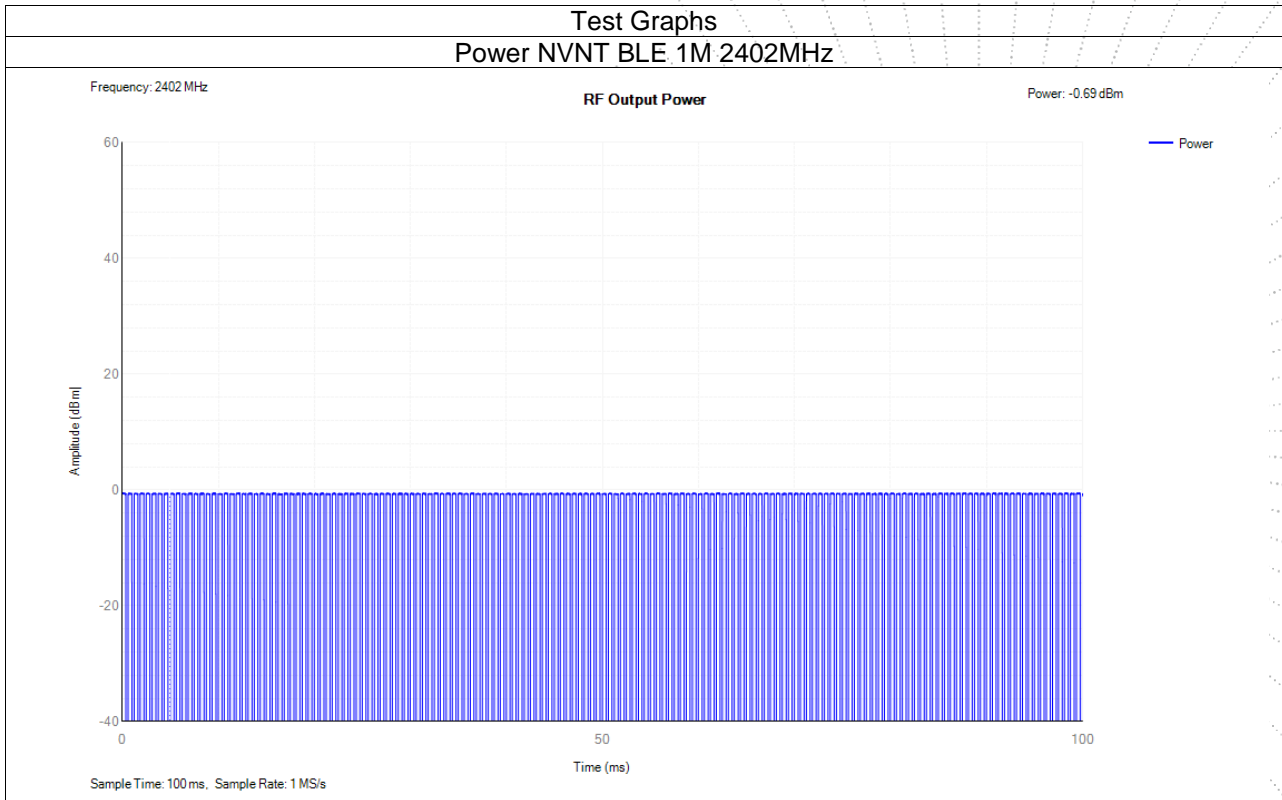

TEST  
 TO  
 OVER  
 検査



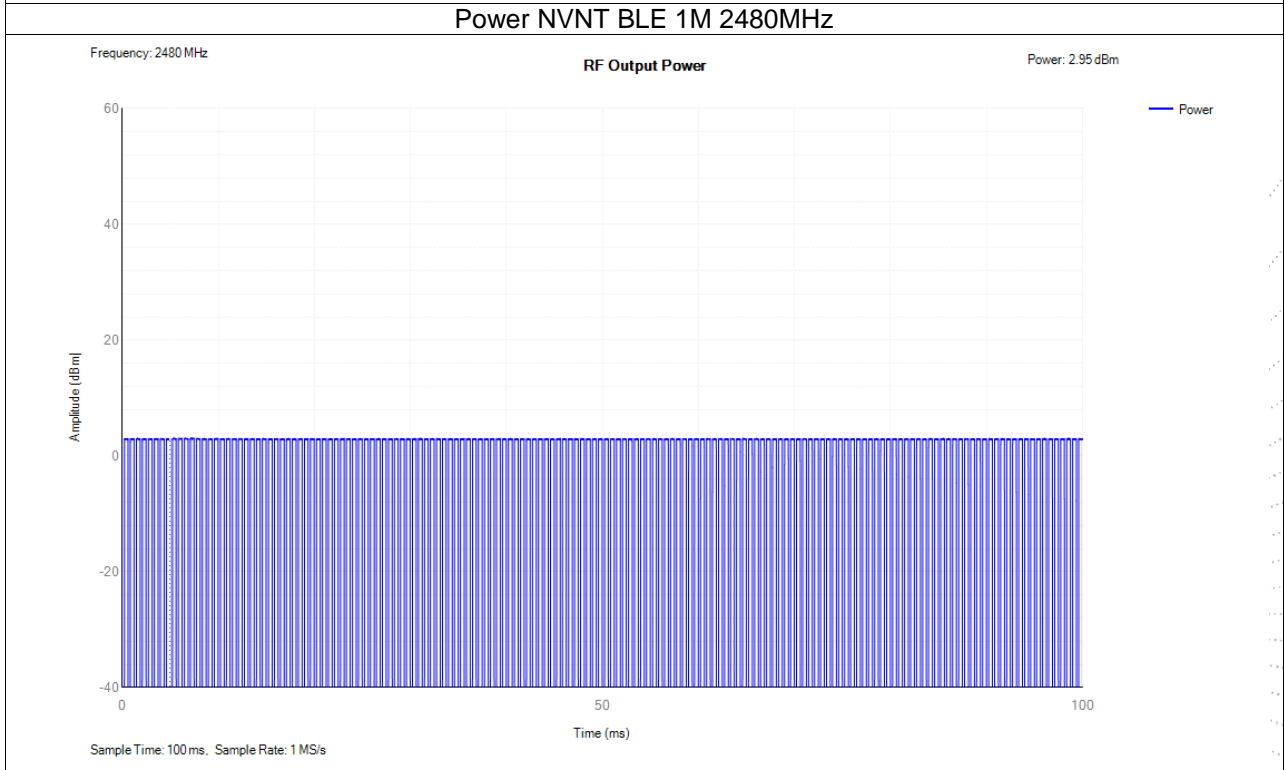
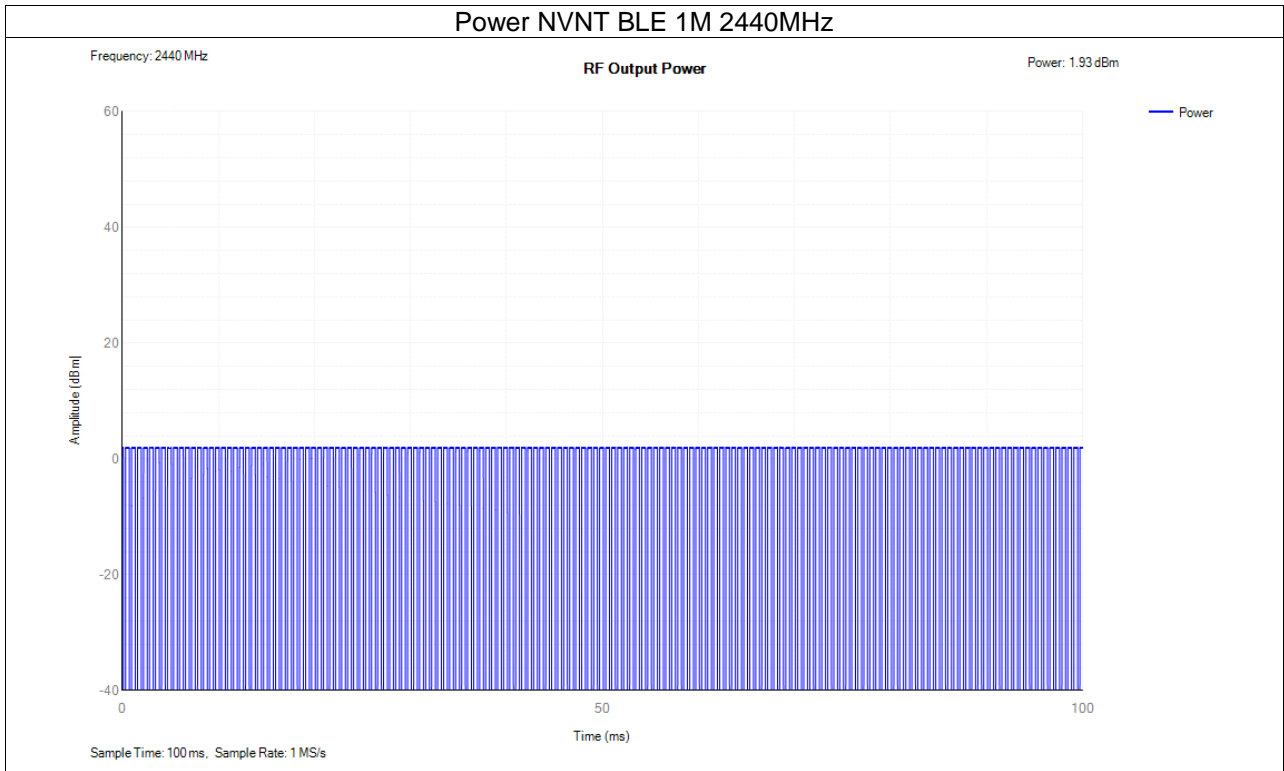

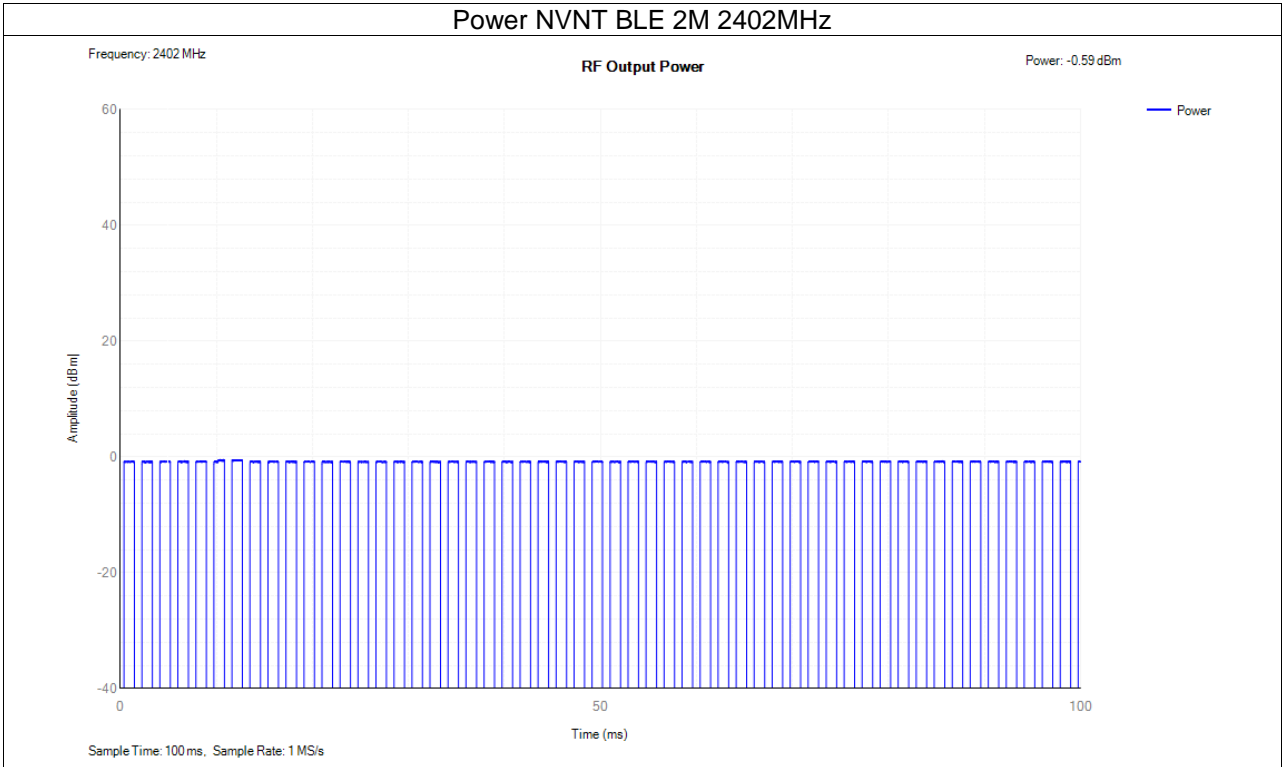
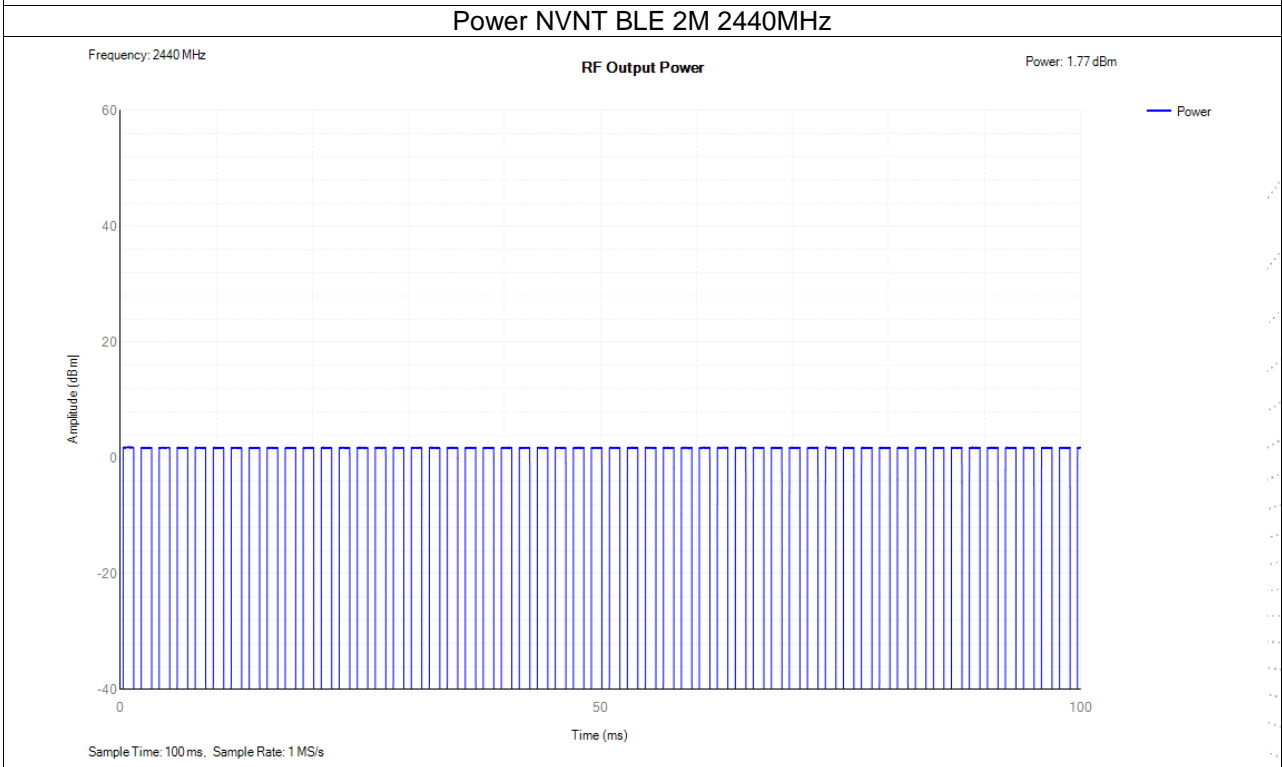
**Power NVNT BLE 2M 2402MHz****Power NVNT BLE 2M 2440MHz**

CO., LTD

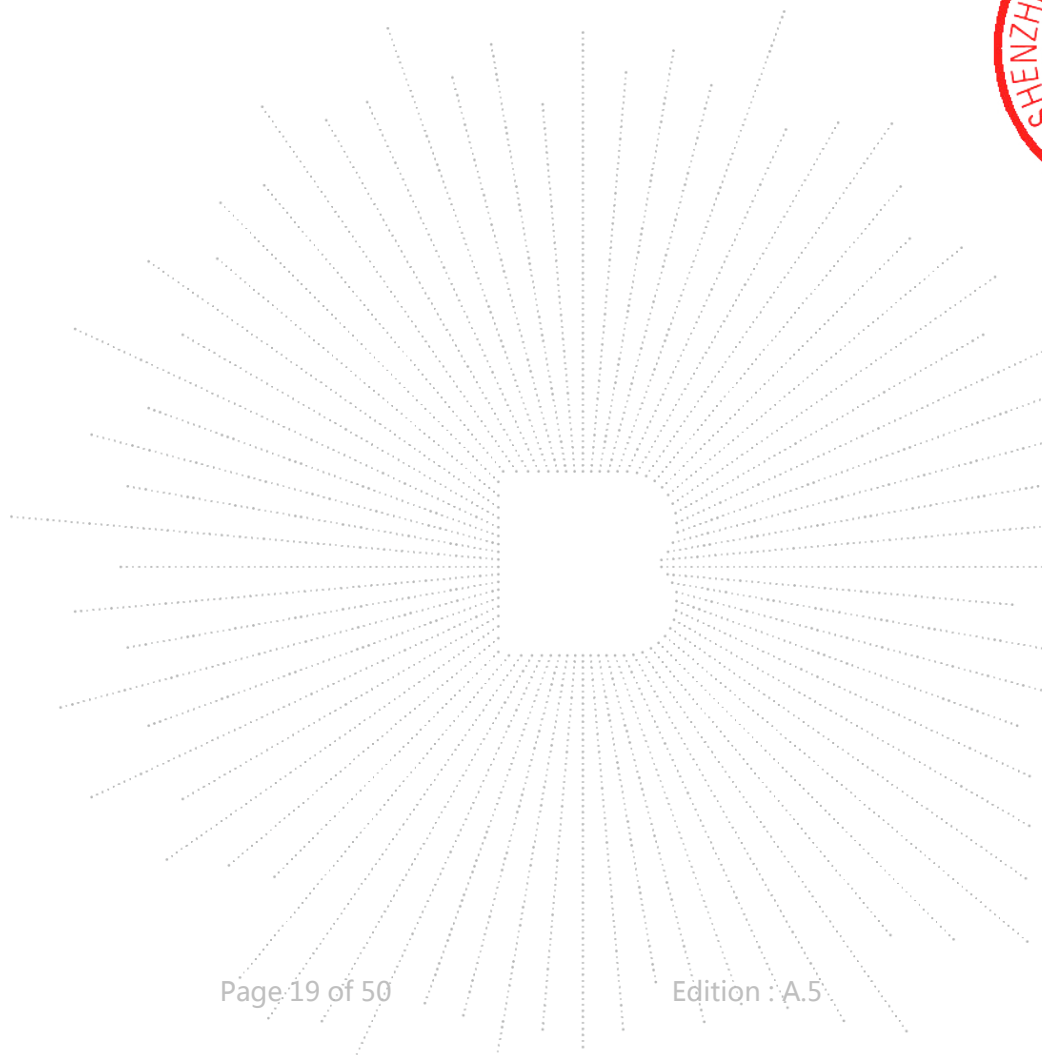
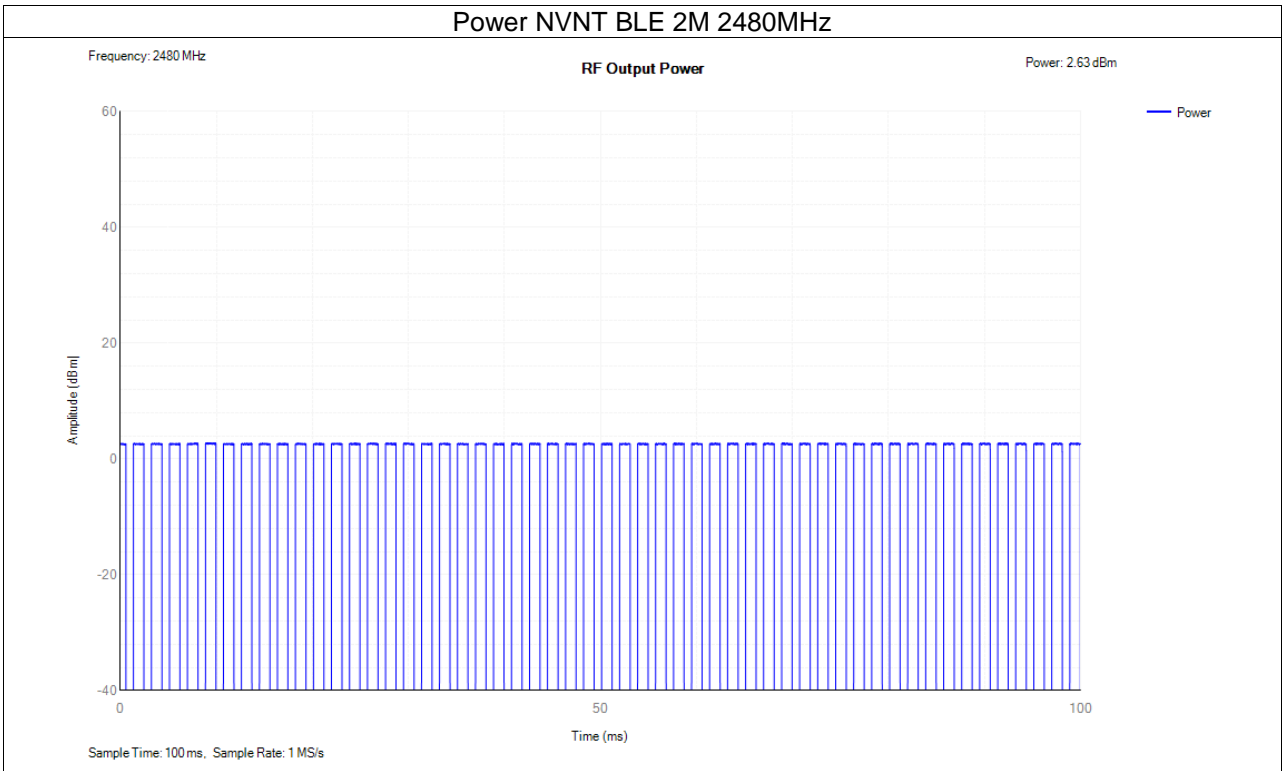

## 8. Power Spectral Density

### 8.1 Block Diagram Of Test Setup

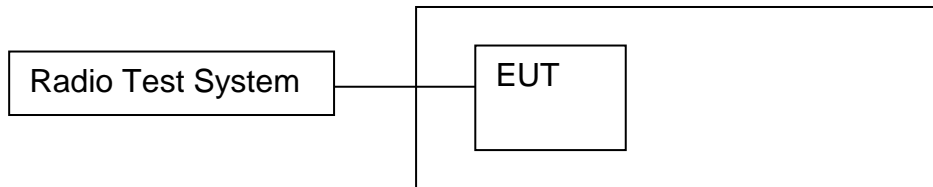

### 8.2 Limit

The maximum Power Spectral Density for non-FHSS equipment is 10 dBm per MHz

Limit
10dBm/MHz

### 8.3 Test Procedure

#### Step 1:

Connect the UUT to the spectrum analyzer and use the following settings:

- Start Frequency: 2 400 MHz
- Stop Frequency: 2 483,5 MHz
- Resolution BW: 10 kHz
- Video BW: 30 kHz
- Sweep Points: > 8 350 ;for spectrum analyzers not supporting this number of sweep points, the frequency band may be segmented
- Detector: RMS
- Trace Mode: Max Hold
- Sweep time: For non-continuous transmissions:  $2 \times \text{Channel Occupancy Time} \times \text{number of sweep points}$   
 For non-adaptive equipment use the maximum TX-sequence time in the formula above instead of the Channel Occupancy Time  
 For continuous transmissions: 10 s; the sweep time may be increased further until a value where the sweep time has no further impact anymore on the RMS value of the signal

For non-continuous signals, wait for the trace to stabilize. Save the data (trace data) set to a file.



**Step 2:**

For conducted measurements on smart antenna systems using either operating mode 2 or operating mode 3 (see clause 5.1.3.2), repeat the measurement for each of the transmit ports. For each sampling point (frequency domain), add up the coincident power values (in mW) for the different transmit chains and use this as the new data set.

**Step 3:**

Add up the values for power for all the samples in the file using the formula below.

$$P_{Sum} = \sum_{n=1}^k P_{sample}(n)$$

**Step 4:** with 'k' being the total number of samples and 'n' the actual sample number

Normalize the individual values for power (in dBm) so that the sum is equal to the RF Output Power (e.i.r.p.) measured in clause 5.3.2 and save the corrected data. The following formulas can be used:

$$C_{Corr} = P_{Sum} - P_{e.i.r.p.}$$

$$P_{Samplecorr}(n) = P_{Sample}(n) - C_{Corr}$$

**Step 5:** with 'n' being the actual sample number

Starting from the first sample  $P_{Samplecorr}(n)$  (lowest frequency), add up the power (in mW) of the following samples representing a 1 MHz segment and record the results for power and position (i.e. sample #1 to sample #100). This is the Power Spectral Density (e.i.r.p.) for the first 1 MHz segment which shall be recorded.

**Step 6:**

Shift the start point of the samples added up in step 5 by one sample and repeat the procedure in step 5 (i.e. sample #2 to sample #101).

**Step 7:**

Repeat step 6 until the end of the data set and record the Power Spectral Density values for each of the 1 MHz segments. From all the recorded results, the highest value is the maximum Power Spectral Density for the UUT. This value, which shall comply with the limit given in clause 4.3.2.3.3, shall be recorded in the test report.

## 8.4 Test Result

Condition	Mode	Frequency (MHz)	Max PSD (dBm/MHz)	Limit (dBm/MHz)	Verdict
NVNT	BLE 1M	2402	-0.77	10	Pass
NVNT	BLE 1M	2440	1.85	10	Pass
NVNT	BLE 1M	2480	2.87	10	Pass
NVNT	BLE 2M	2402	-2.72	10	Pass
NVNT	BLE 2M	2440	-0.39	10	Pass
NVNT	BLE 2M	2480	0.49	10	Pass

BCTC  
 3C  
 PPR  
 检测

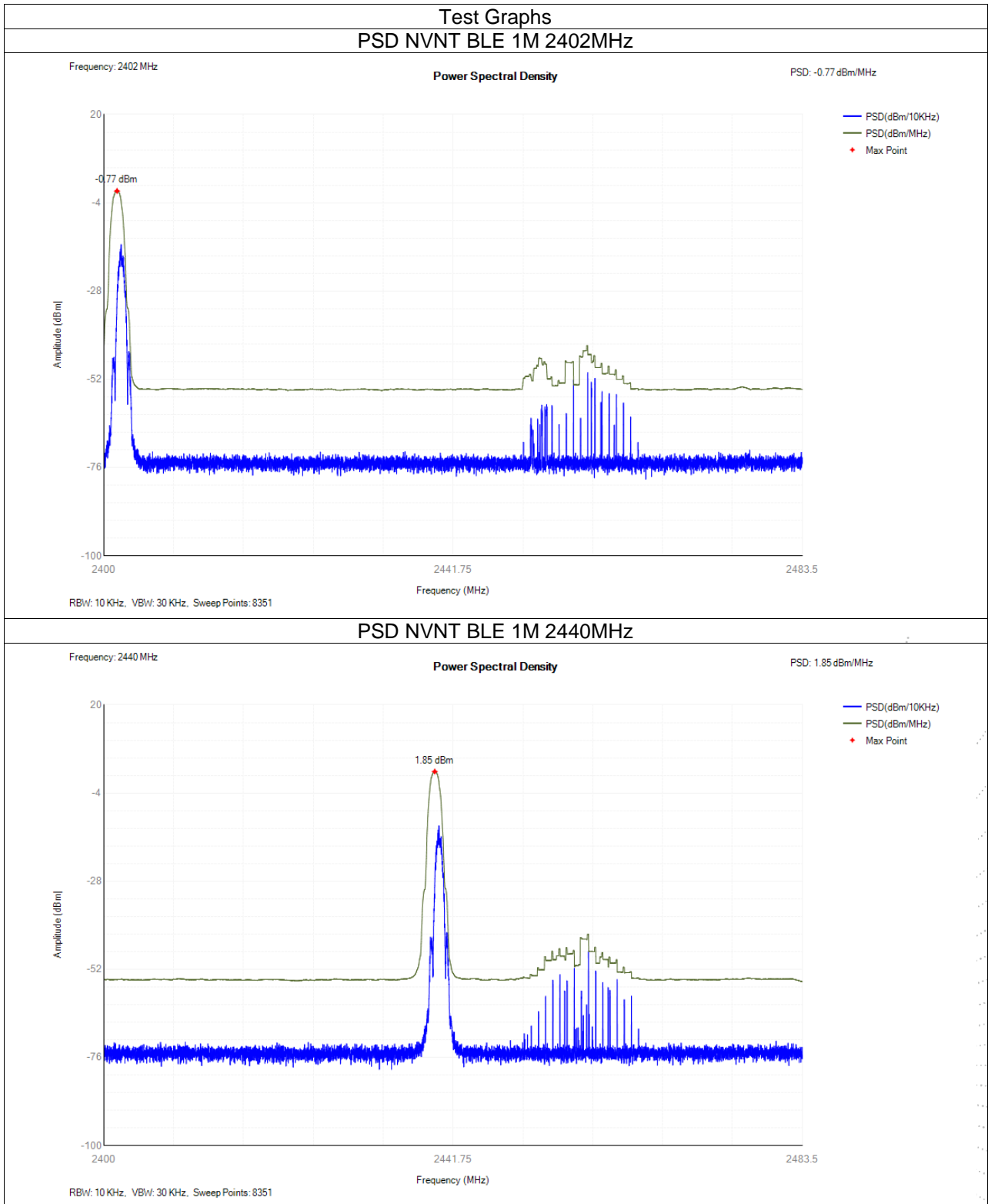

TEC  
TO  
OVER  
檢

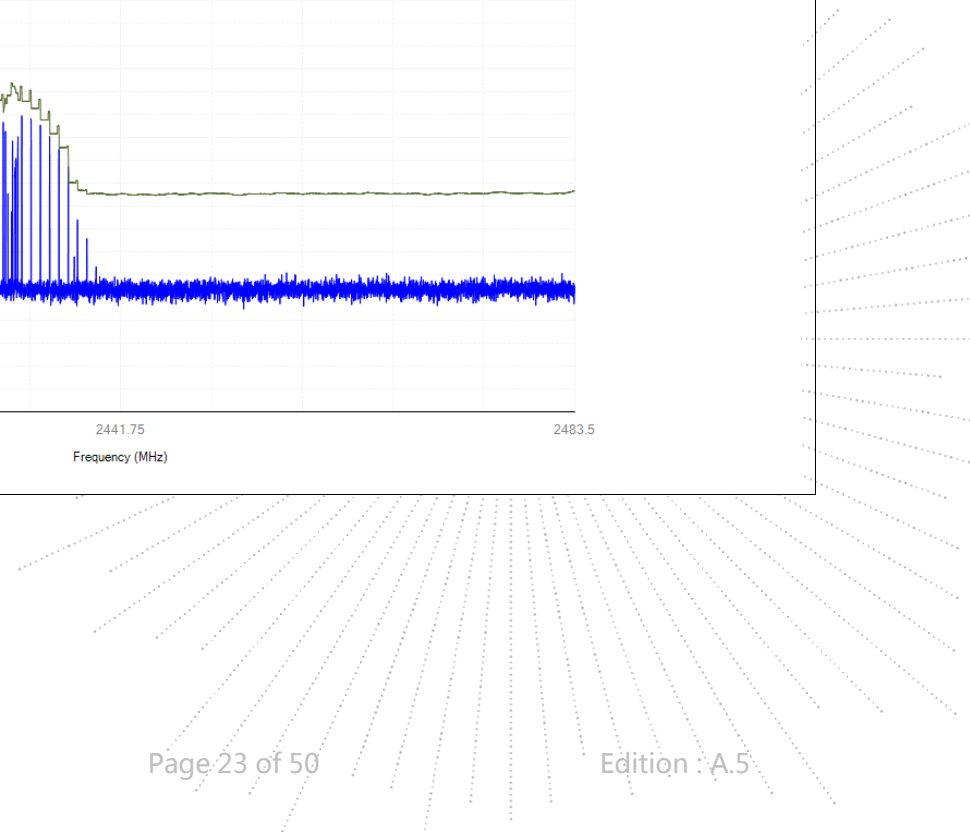
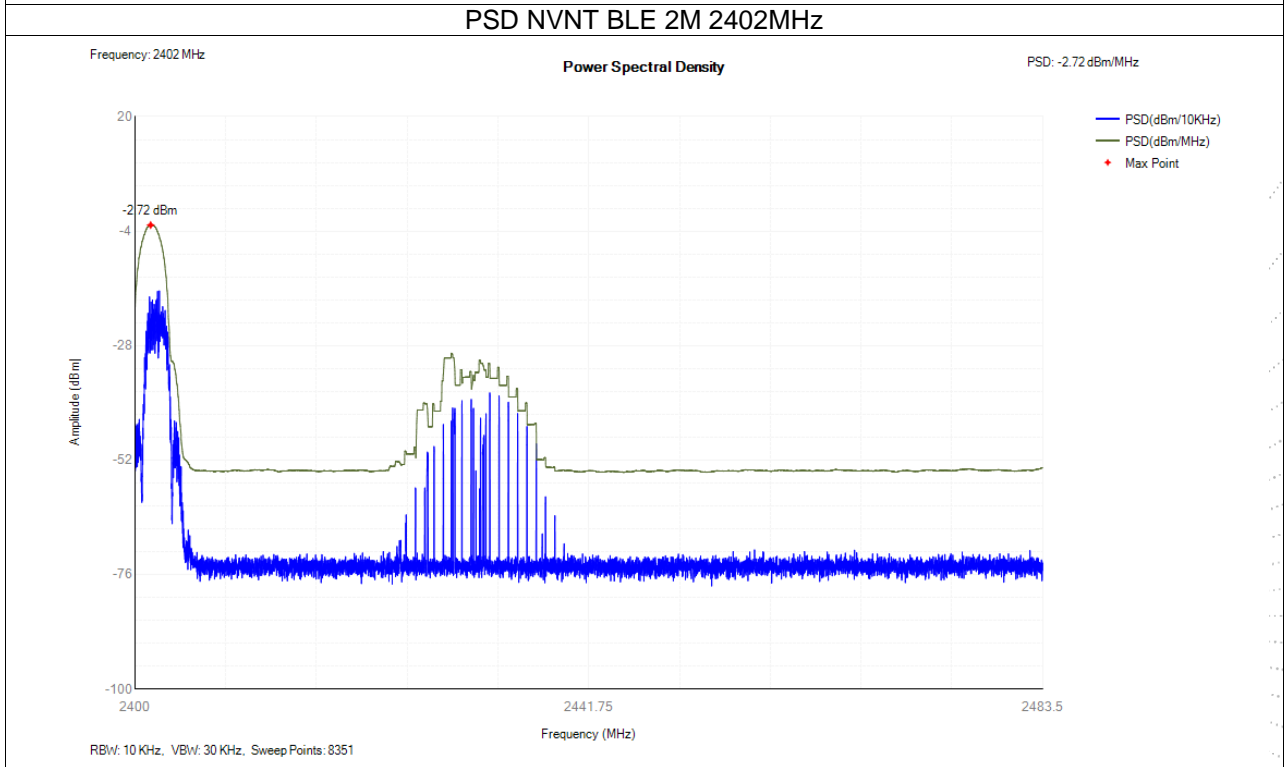
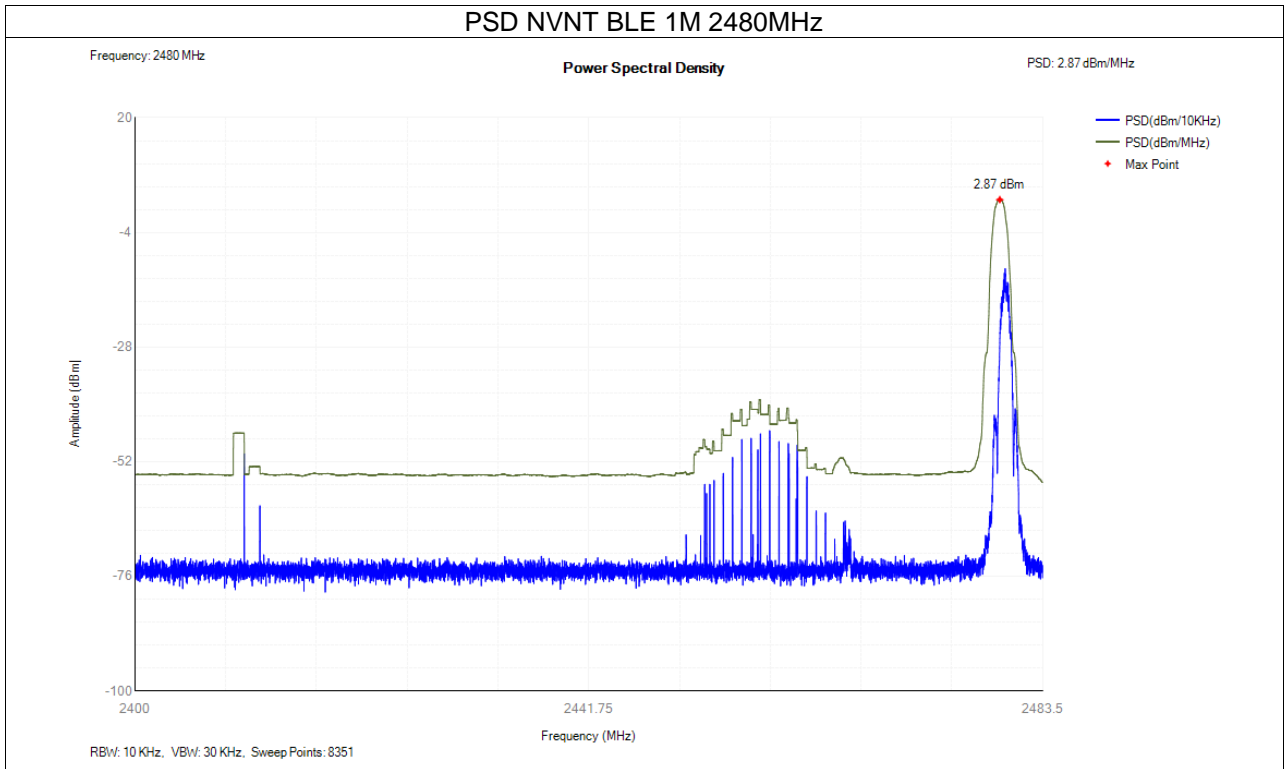

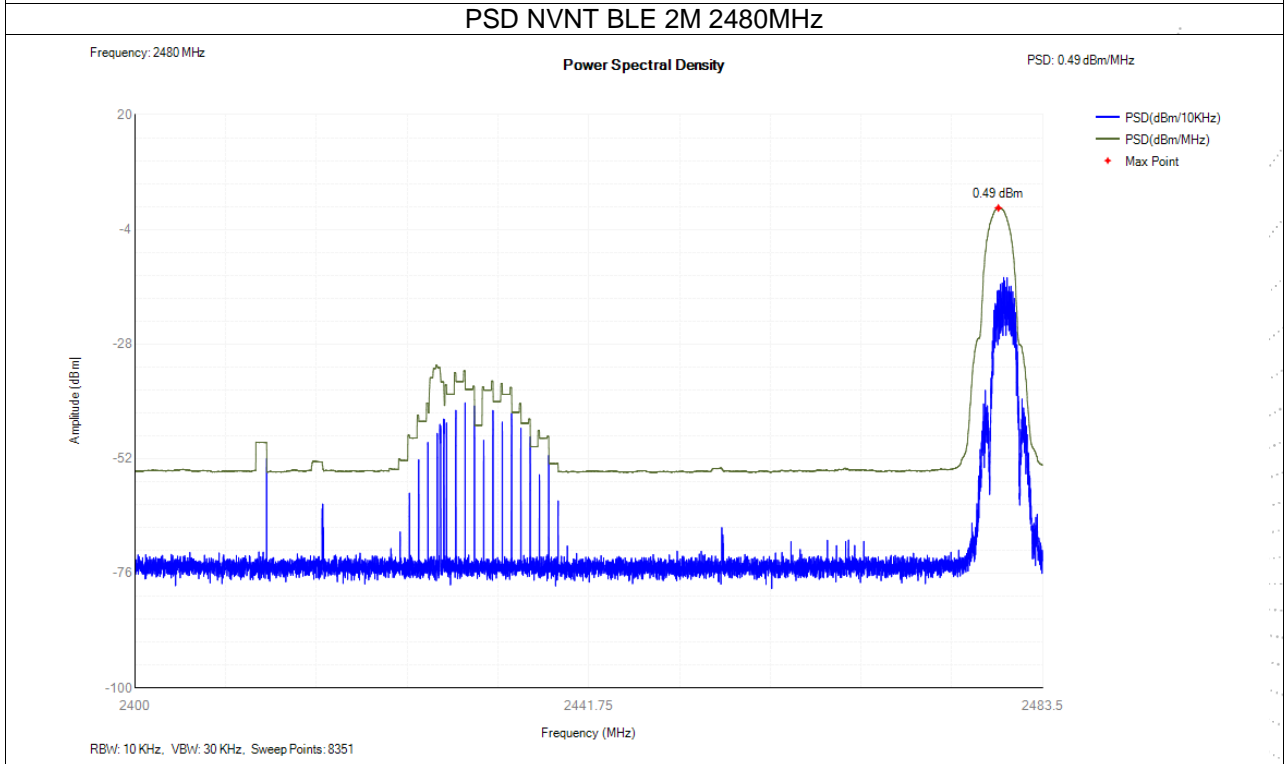
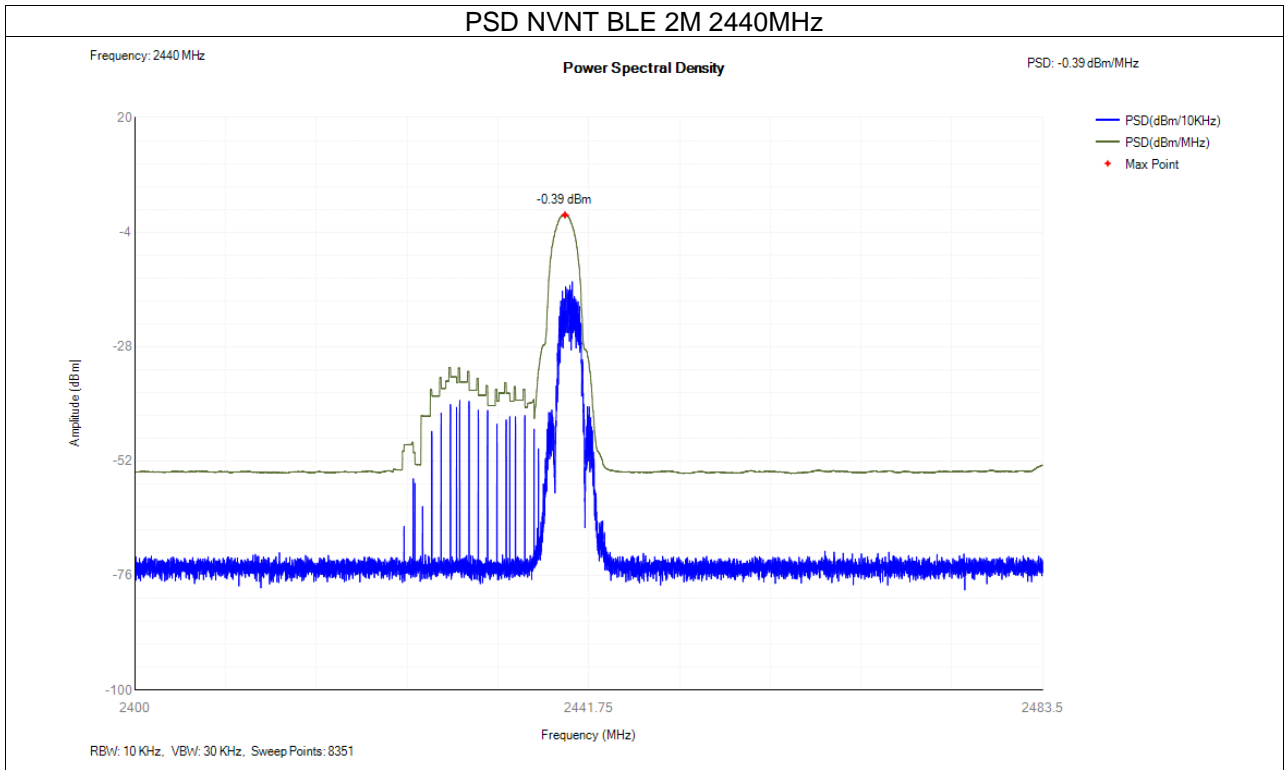

CO., LTD



## 9. Adaptivity

### 9.1 Block Diagram Of Test Setup

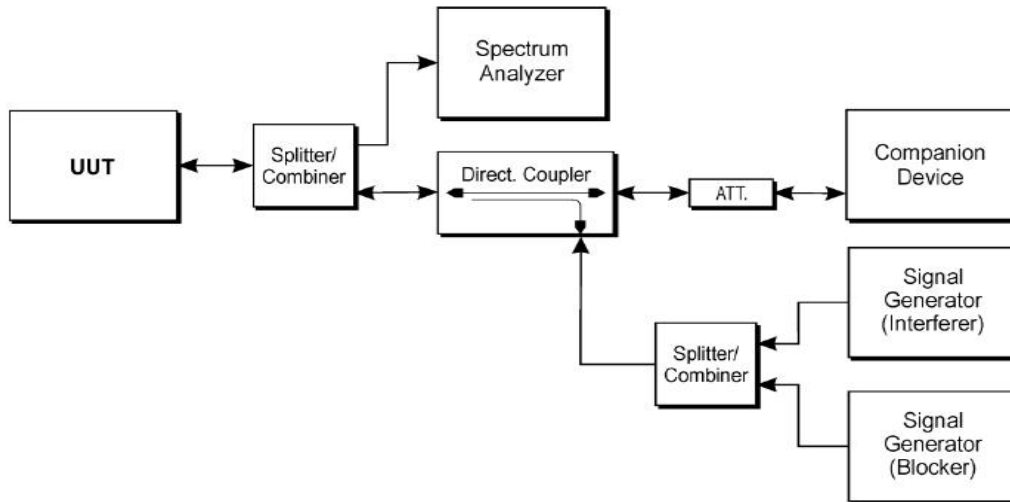

### 9.2 Limit

The frequency range of the equipment is determined by the lowest and highest

Non-LBT based Detect and Avoid: 1 The frequency shall remain unavailable for a minimum time equal to 1 second after which the channel maybe considered again as an 'available' channel; 2 COT $\leq$ 40 ms; 3 Idle Period = 5% of COT; 4 Detection threshold level = $-70\text{dBm/MHz} + 20 - \text{Pout E.I.R.P}$ (Pout in dBm);
LBT based Detect and Avoid (Frame Based Equipment): 1 Minimum Clear Channel Assessment (CCA) time = 20 $\mu$ s; 2 CCA observation time declared by the supplier; 3 COT = 1~10 ms; 4 Idle Period = 5% of COT; 5 Detection threshold level = $-70\text{dBm/MHz} + 20 - \text{Pout E.I.R.P}$ (Pout in dBm);
LBT based Detect and Avoid (Load Based Equipment): 1 Minimum Clear Channel Assessment (CCA) time = 20 $\mu$ s; 2 CCA declared by the manufacturer; 3 COT $\leq$ $(13 / 32) * q$ ms; q = [4~32]; 1.625ms~13ms; 4 Detection threshold level = $-73\text{dBm/MHz} + 20 - \text{Pout E.I.R.P}$ (dBm);
Short Control Signalling Transmissions: Short Control Signalling Transmissions shall have a maximum duty cycle of 10% within an observation period of 50ms.

## 9.3 Test Procedure

### Step 1:

The UUT may connect to a companion device during the test. The interference signal generator, the blocking signal generator, the spectrum analyzer, the UUT and the companion device are connected using a set-up equivalent to the example given by figure 5 although the interference and blocking signal generator do not generate any signals at this point in time. The spectrum analyzer is used to monitor the transmissions of the UUT in response to the interfering and the blocking signals.

Adjust the received signal level (wanted signal from the companion device) at the UUT to the value defined in table 6

The analyzer shall be set as follows:

- RBW:  $\geq$  Occupied Channel Bandwidth (if the analyzer does not support this setting, the highest available setting shall be used)
- VBW:  $3 \times$  RBW (if the analyzer does not support this setting, the highest available setting shall be used)
- Detector Mode: RMS
- Centre Frequency: Equal to the centre frequency of the operating channel
- Span: 0 Hz
- Sweep time:  $>$  Channel Occupancy Time of the UUT
- Trace Mode: Clear/Write
- Trigger Mode: Video

### Step 2:

Configure the UUT for normal transmissions with a sufficiently high payload to allow demonstration of compliance of the adaptive mechanism on the channel being tested

Using the procedure defined in clause 5.3.7.2.1.4, it shall be verified that the UUT complies with the maximum Channel Occupancy Time and minimum Idle Period

### Step 3: Adding the interference signal

A 100 % duty cycle interference signal is injected on the current operating channel of the UUT. This interference signal shall be a band limited noise signal which has a flat power spectral density, and shall have a bandwidth greater than the Occupied Channel Bandwidth of the UUT. The maximum ripple of this interfering signal shall be  $\pm 1,5$  dB within the Occupied Channel Bandwidth and the power spectral density.

### Step 4: Verification of reaction to the interference signal

The spectrum analyzer shall be used to monitor the transmissions of the UUT on the selected operating channel with the interfering signal injected. This may require the spectrum analyzer sweep to be triggered by the start of the interfering signal.

Using the procedure defined in clause 5.3.7.2.1.4, it shall be verified that:

The UUT shall stop transmissions on the current operating channel being tested.

Apart from Short Control Signalling Transmissions (see iii) below), there shall be no subsequent transmissions on this operating channel for a (silent) period defined in clause 4.3.2.5.1.2 step 2. After that, the UUT may have normal transmissions again for the duration of a single Channel Occupancy Time period. Because the interference signal is still present, another silent period as defined in clause 4.3.2.5.1.2 step 2 needs to be included. This sequence is repeated as long as the interfering signal is present.

The UUT may continue to have Short Control Signalling Transmissions on the operating channel while the interference signal is present. These transmissions shall comply with the limits  
Alternatively, the equipment may switch to a non-adaptive mode

### Step 5: Adding the blocking signal

With the interfering signal present, a 100 % duty cycle CW signal is inserted as the blocking signal  
Repeat step 4 to verify that the UUT does not resume any normal transmissions



**Step 6: Removing the interference and blocking signal**

On removal of the interference and blocking signal the UUT is allowed to start transmissions again on this channel however, it shall be verified that this shall only be done after the period defined in clause 4.3.2.5.1.2 step 2.

**Step 7:**

The steps 2 to 6 shall be repeated for each of the frequencies to be tested.

**9.4 Test Result**

Remark: this requirement does not apply for equipment when operating in a mode where the RF Output power is less than 10 dBm e.i.r.p.

TC  
3C  
PPR  
測

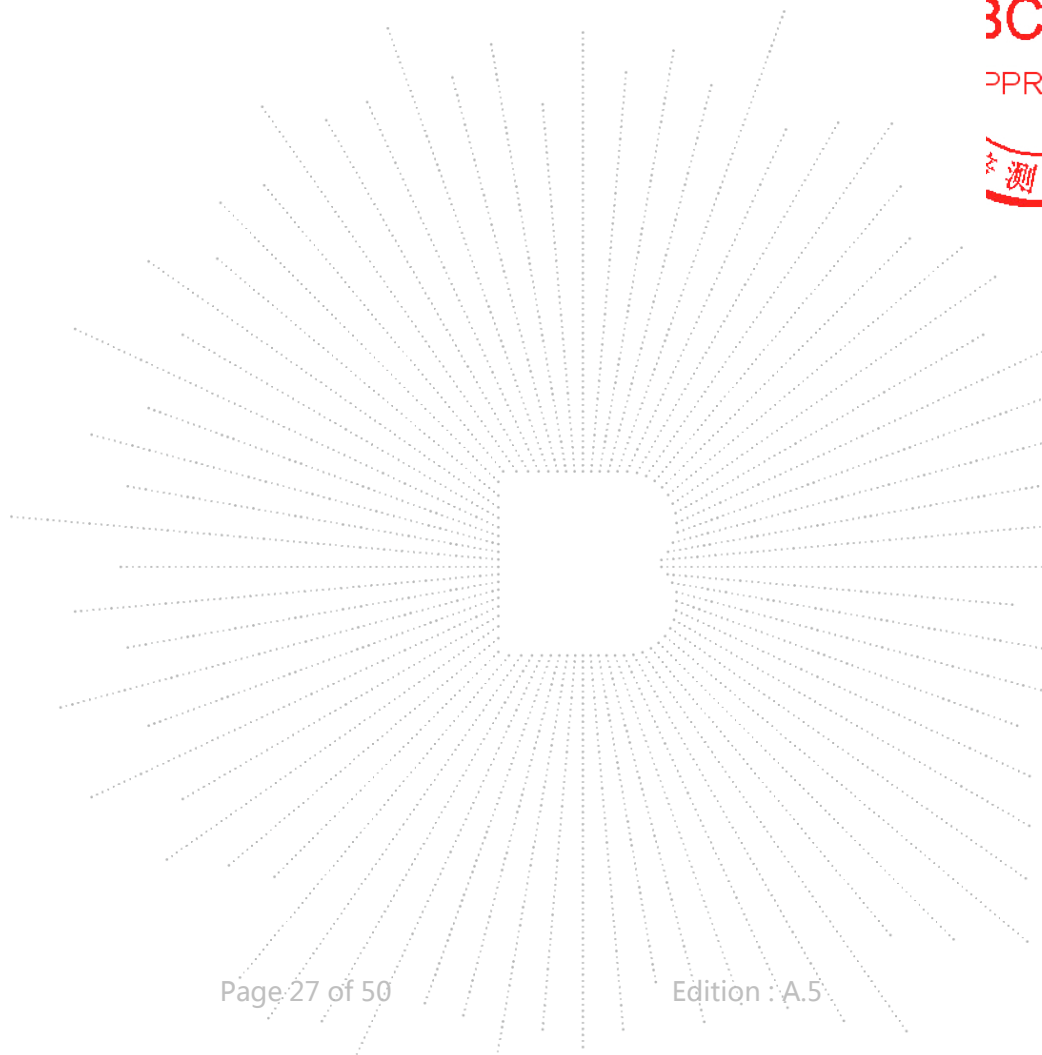

## 10. Occupied Channel Bandwidth

### 10.1 Block Diagram Of Test Setup

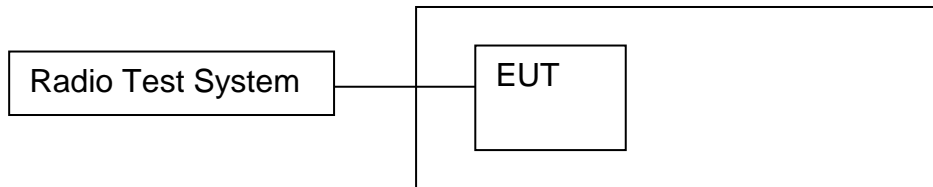

### 10.2 Limit

The Occupied Channel Bandwidth shall fall completely within the band given in 2.4GHz to 2.4835GHz. In addition, for non-adaptive non-FHSS equipment with e.i.r.p. greater than 10 dBm, the Occupied Channel Bandwidth shall be equal to or less than 20 MHz.

### 10.3 Test Procedure

#### Step 1:

Connect the UUT to the spectrum analyzer and use the following settings:

- Centre Frequency: The centre frequency of the channel under test
- Resolution BW: ~ 1 % of the span without going below 1 %
- Video BW: 3 × RBW
- Frequency Span: 2 × Nominal Channel Bandwidth
- Detector Mode: RMS
- Trace Mode: Max Hold
- Sweep time: 1 s

#### Step 2:

Wait for the trace to stabilize.

Find the peak value of the trace and place the analyzer marker on this peak.

#### Step 3:

Use the 99 % bandwidth function of the spectrum analyzer to measure the Occupied Channel Bandwidth of the UUT.

This value shall be recorded.

NOTE: Make sure that the power envelope is sufficiently above the noise floor of the analyzer to avoid the noise signals left and right from the power envelope being taken into account by this measurement.

## 10.4 Test Result

Condition	Mode	Frequency (MHz)	Center Frequency (MHz)	OBW (MHz)	Lower Edge (MHz)	Upper Edge (MHz)	Limit OBW (MHz)	Verdict
NVNT	BLE 1M	2402	2402.087	1.056	2401.559	2402.615	2400 - 2483.5MHz	Pass
NVNT	BLE 1M	2480	2480.099	1.055	2479.572	2480.627	2400 - 2483.5MHz	Pass
NVNT	BLE 2M	2402	2402	<b>2.207</b>	2400.897	2403.104	2400 - 2483.5MHz	Pass
NVNT	BLE 2M	2480	2480.01	2.206	2478.907	2481.113	2400 - 2483.5MHz	Pass

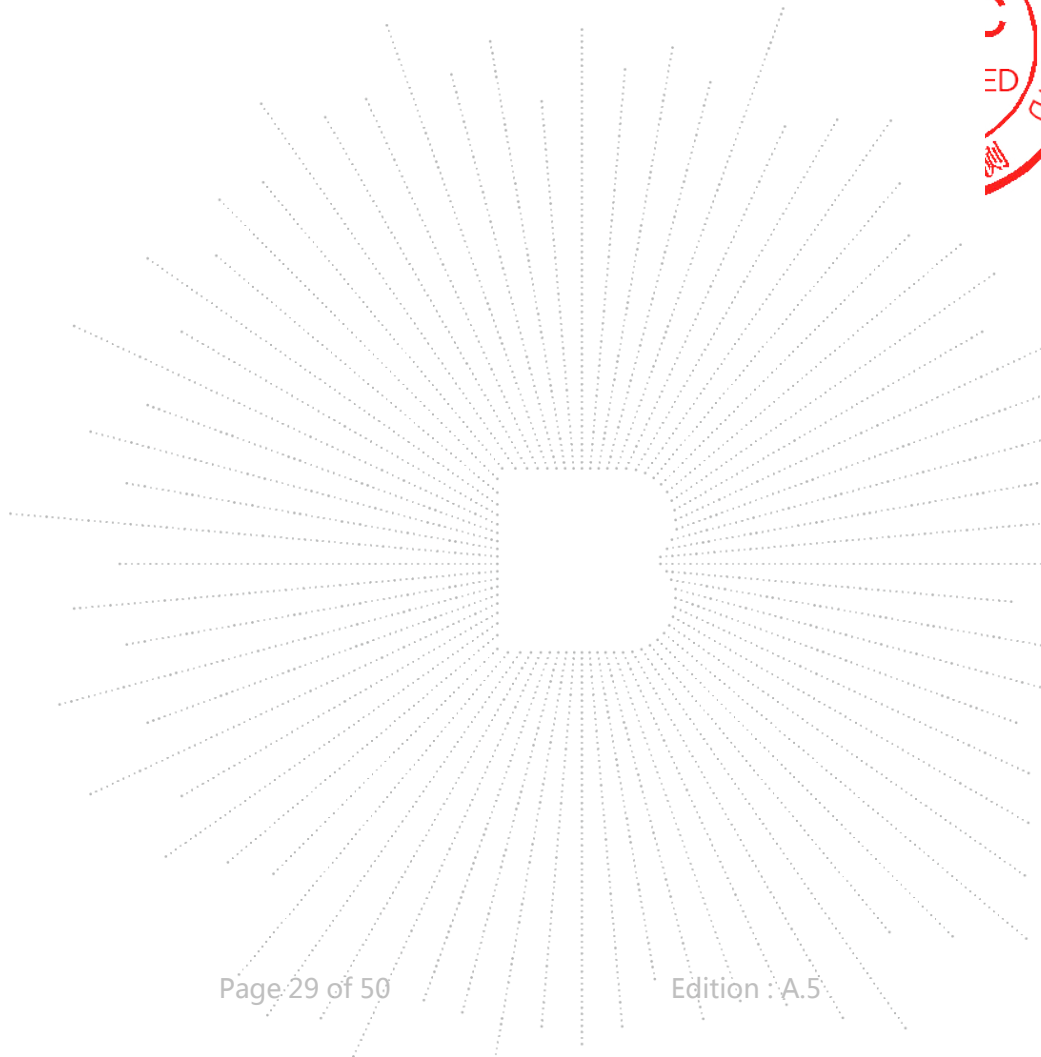

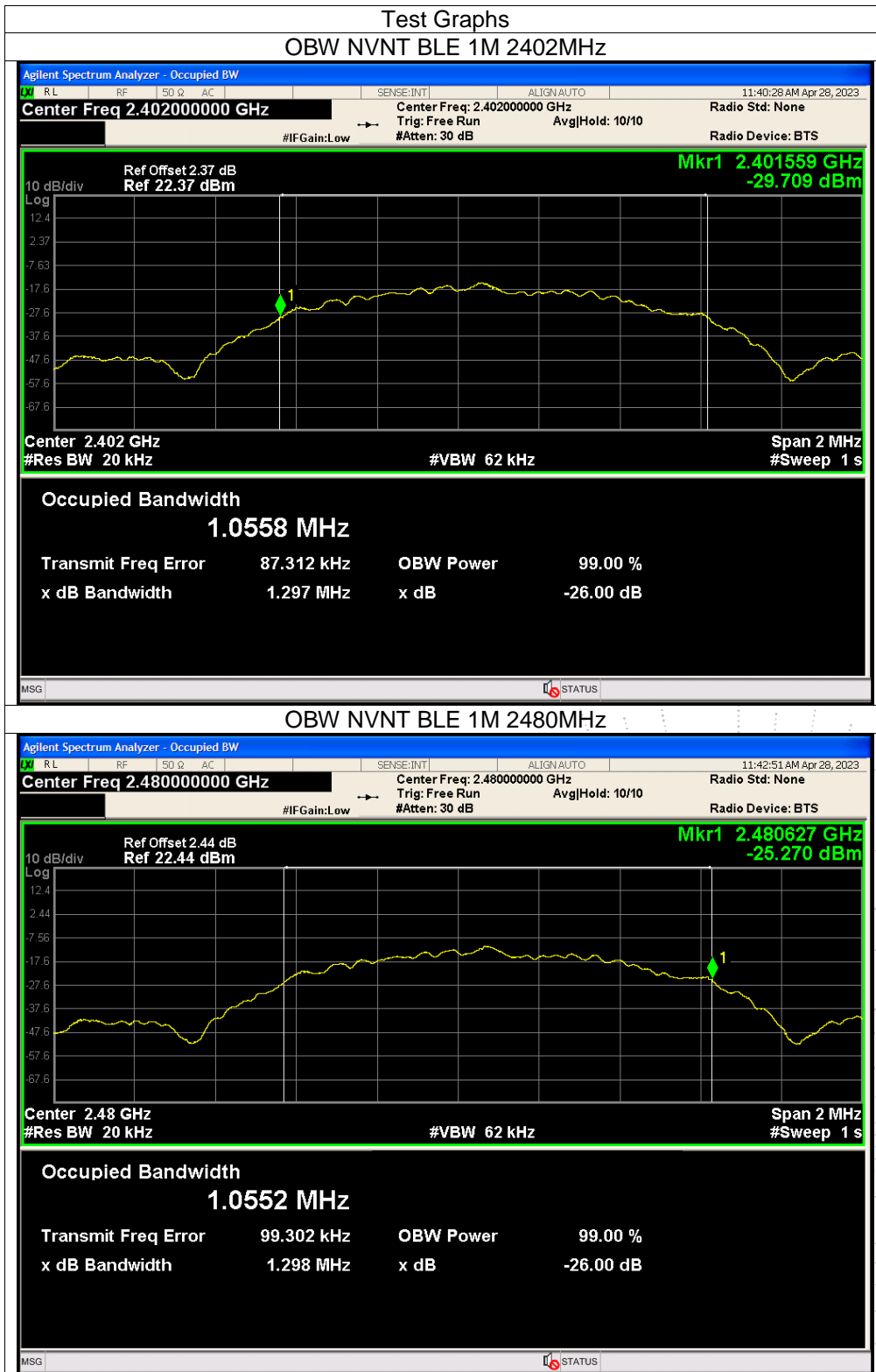

CO., LTD

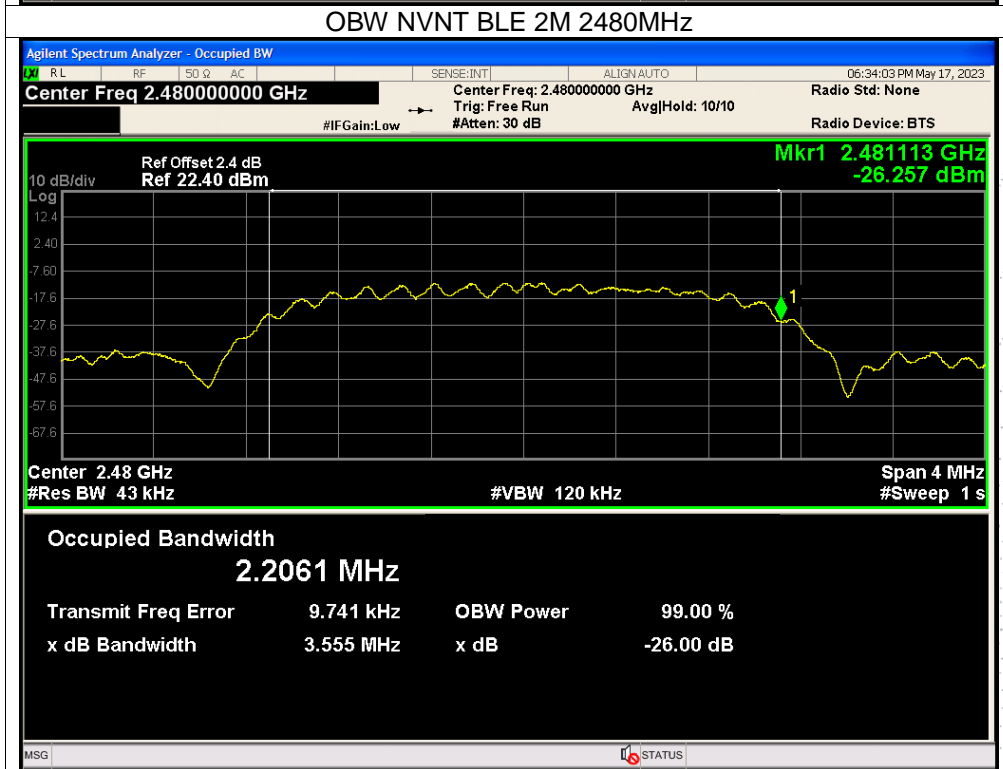
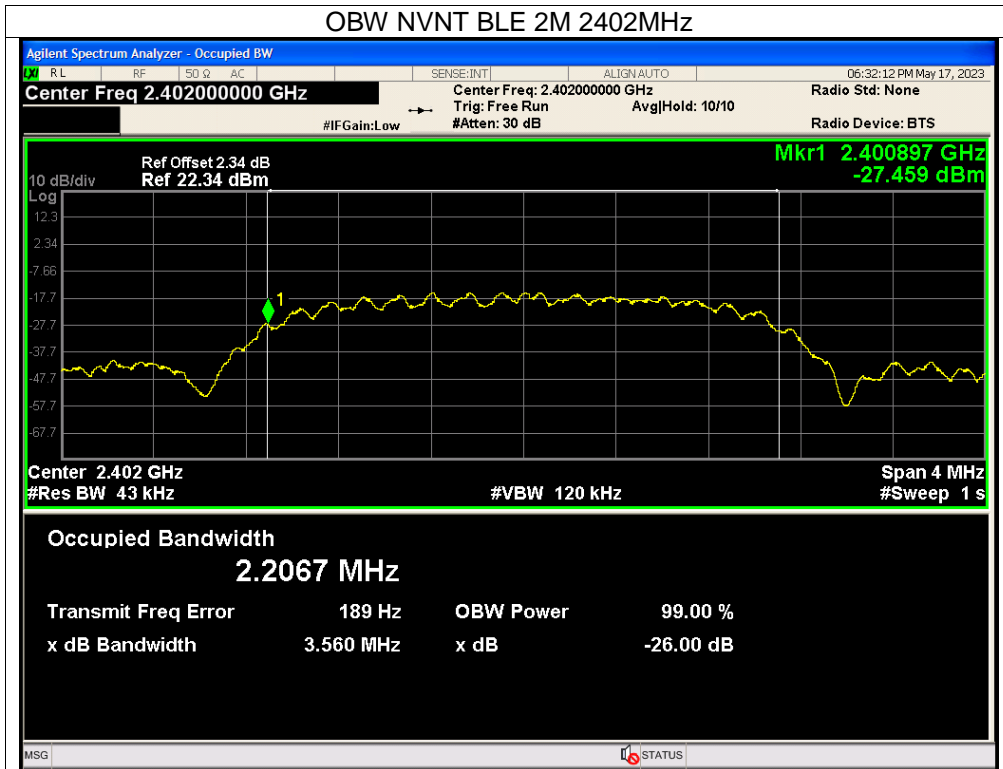

## 11. Transmitter Unwanted Emissions In The Out-Of-Band Domain

### 11.1 Block Diagram Of Test Setup

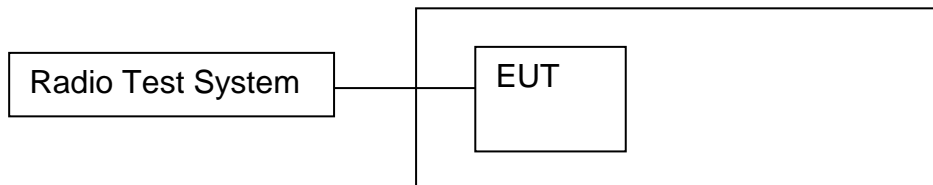

### 11.2 Limit

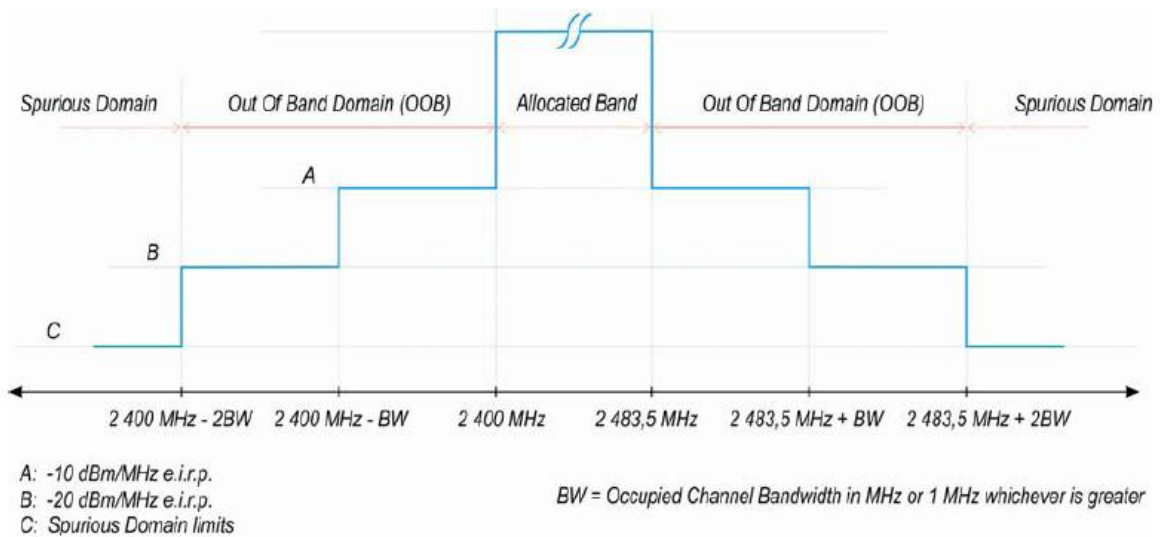

**Figure 3: Transmit mask**

### 11.3 Test Procedure

The applicable mask is defined by the measurement results from the tests performed under clause 5.4.7 (Occupied Channel Bandwidth).

The Out-of-band emissions within the different horizontal segments of the mask provided in figure 1 and figure 3 shall be measured using the procedure in step 1 to step 6 below. This method assumes the spectrum analyzer is equipped with the Time Domain Power option.

#### Step 1:

- Connect the UUT to the spectrum analyzer and use the following settings:
  - Measurement Mode: Time Domain Power
  - Centre Frequency: 2 484 MHz
  - Span: Zero Span
  - Resolution BW: 1 MHz
  - Filter mode: Channel filter
  - Video BW: 3 MHz
  - Detector Mode: RMS



- Trace Mode: Max Hold
- Sweep Mode: Single Sweep
- Sweep Points: Sweep time [ $\mu$ s] / (1  $\mu$ s) with a maximum of 30 000
- Trigger Mode: Video
- Sweep Time: >120 % of the duration of the longest burst detected during the measurement of the RF Output Power

**Step 2 (segment 2 483,5 MHz to 2 483,5 MHz + BW):**

- The measurement shall be performed and repeated while the trigger level is increased until no triggering takes place.
- For FHSS equipment operating in a normal hopping mode, the different hops will result in signal bursts with different power levels. In this case the burst with the highest power level shall be selected.
  - Set a window (start and stop lines) to match with the start and end of the burst and in which the RMS power shall be measured using the Time Domain Power function..
- Select RMS power to be measured within the selected window and note the result which is the RMS power within this 1 MHz segment (2 483,5 MHz to 2 484,5 MHz). Compare this value with the applicable limit provided by the mask.
- Increase the centre frequency in steps of 1 MHz and repeat this measurement for every 1 MHz segment within the range 2 483,5 MHz to 2 483,5 MHz + BW. The centre frequency of the last 1 MHz segment shall be set to 2 483,5 MHz + BW - 0,5 MHz (which means this may partly overlap with the previous 1 MHz segment).

**Step 3 (segment 2 483,5 MHz + BW to 2 483,5 MHz + 2BW):**

- Change the centre frequency of the analyzer to 2 484 MHz + BW and perform the measurement for the first 1 MHz segment within range 2 483,5 MHz + BW to 2 483,5 MHz + 2BW. Increase the centre frequency in 1 MHz steps and repeat the measurements to cover this whole range. The centre frequency of the last 1 MHz segment shall be set to 2 483,5 MHz + 2 BW - 0,5 MHz (which means this may partly overlap with the previous 1 MHz segment).

**Step 4 (segment 2 400 MHz - BW to 2 400 MHz):**

- Change the centre frequency of the analyzer to 2 399,5 MHz and perform the measurement for the first 1 MHz segment within range 2 400 MHz - BW to 2 400 MHz Reduce the centre frequency in 1 MHz steps and repeat the measurements to cover this whole range. The centre frequency of the last 1 MHz segment shall be set to 2 400 MHz - BW + 0,5 MHz (which means this may partly overlap with the previous 1 MHz segment).

**Step 5 (segment 2 400 MHz - 2BW to 2 400 MHz - BW):**

- Change the centre frequency of the analyzer to 2 399,5 MHz - BW and perform the measurement for the first 1 MHz segment within range 2 400 MHz - 2BW to 2 400 MHz - BW. Reduce the centre frequency in 1 MHz steps and repeat the measurements to cover this whole range. The centre frequency of the last 1 MHz segment shall be set to 2 400 MHz - 2BW + 0,5 MHz (which means this may partly overlap with the previous 1 MHz segment).

**Step 6:**

- In case of conducted measurements on equipment with a single transmit chain, the declared antenna assembly gain G in dBi shall be added to the results for each of the 1 MHz segments and compared with the limits provided by the mask given in figure 1 or figure 3. If more than one antenna assembly is intended for this power setting, the antenna with the highest gain shall be considered.
- In case of conducted measurements on smart antenna systems (equipment with multiple transmit chains), the measurements need to be repeated for each of the active transmit chains. The declared antenna assembly gain "G" in dBi for a single antenna shall be added to these results. If more than one antenna assembly is intended for this power setting, the antenna with the highest gain shall be considered. Comparison with the applicable limits shall be done using any of the options given below:
  - Option 1: the results for each of the transmit chains for the corresponding 1 MHz segments shall be added. The additional beamforming gain "Y" in dB shall be added as well and the resulting values compared with the limits provided by the mask given in figure 1 or figure 3.
  - Option 2: the limits provided by the mask given in figure 1 or figure 3 shall be reduced by  $10 \times \log_{10}(A_{ch})$  and the additional beamforming gain Y in dB. The results for each of the transmit chains shall be individually compared with these reduced limits.

NOTE:  $A_{ch}$  refers to the number of active transmit chains.

It shall be recorded whether the equipment complies with the mask provided in figure 1 or figure 3.

## 11.4 Test Result

Condition	Mode	Frequency (MHz)	OOB Frequency (MHz)	Level (dBm/MHz)	Limit (dBm/MHz)	Verdict
NVNT	BLE 1M	2402	2399.5	-60.31	-10	Pass
NVNT	BLE 1M	2402	2399.444	-60.88	-10	Pass
NVNT	BLE 1M	2402	2398.444	-65.26	-20	Pass
NVNT	BLE 1M	2402	2398.388	-65.34	-20	Pass
NVNT	BLE 1M	2402	2484	-65.5	-10	Pass
NVNT	BLE 1M	2402	2485	-65.76	-20	Pass
NVNT	BLE 1M	2480	2399.5	-65.78	-10	Pass
NVNT	BLE 1M	2480	2398.5	-65.74	-20	Pass
NVNT	BLE 1M	2480	2484	-63.86	-10	Pass
NVNT	BLE 1M	2480	2484.055	-63.94	-10	Pass
NVNT	BLE 1M	2480	2485.055	-64.14	-20	Pass
NVNT	BLE 1M	2480	2485.11	-64.56	-20	Pass
NVNT	BLE 2M	2402	2399.5	-35.87	-10	Pass
NVNT	BLE 2M	2402	2398.5	-60.54	-10	Pass
NVNT	BLE 2M	2402	2398.293	-61.34	-10	Pass
NVNT	BLE 2M	2402	2397.293	-65.39	-20	Pass
NVNT	BLE 2M	2402	2396.293	-65.81	-20	Pass
NVNT	BLE 2M	2402	2396.086	-65.49	-20	Pass
NVNT	BLE 2M	2480	2484	-65.79	-10	Pass
NVNT	BLE 2M	2480	2485	-65.71	-20	Pass
NVNT	BLE 2M	2480	2399.5	-65.81	-10	Pass
NVNT	BLE 2M	2480	2398.5	-65.73	-20	Pass
NVNT	BLE 2M	2480	2484	-59.99	-10	Pass
NVNT	BLE 2M	2480	2485	-64.11	-10	Pass

TEST  
 TO  
 OVER  
 检

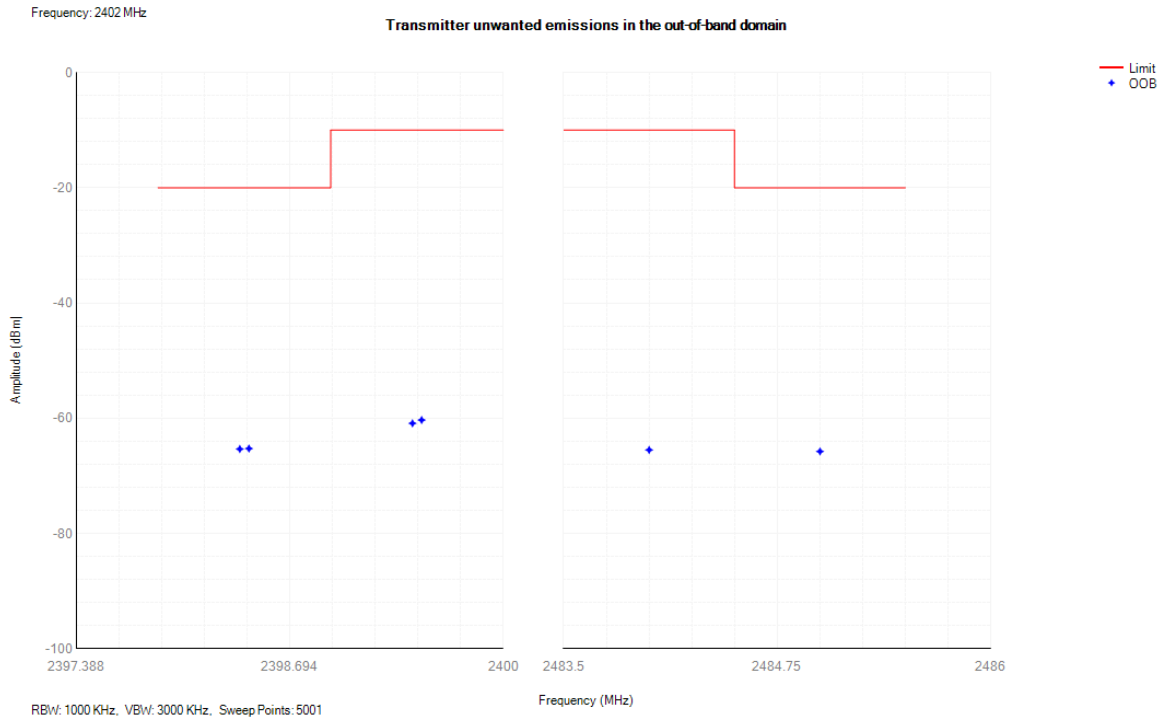
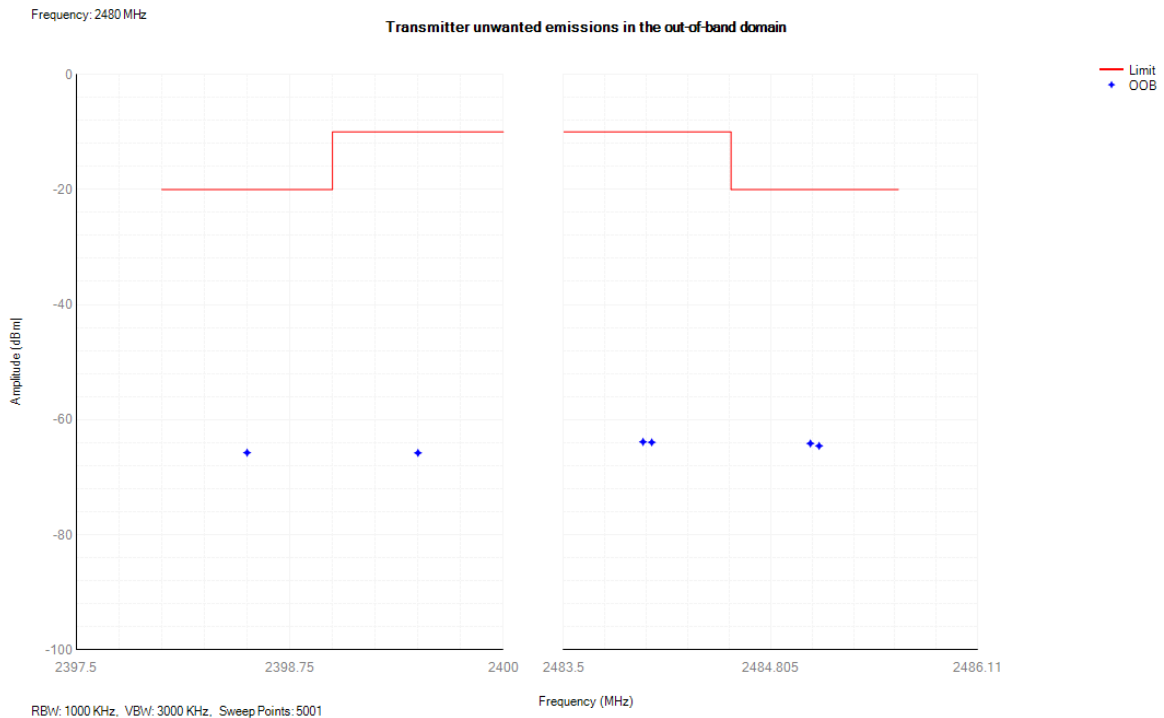
**Test Graphs**
**Tx. Emissions OOB NVNT BLE 1M 2402MHz**

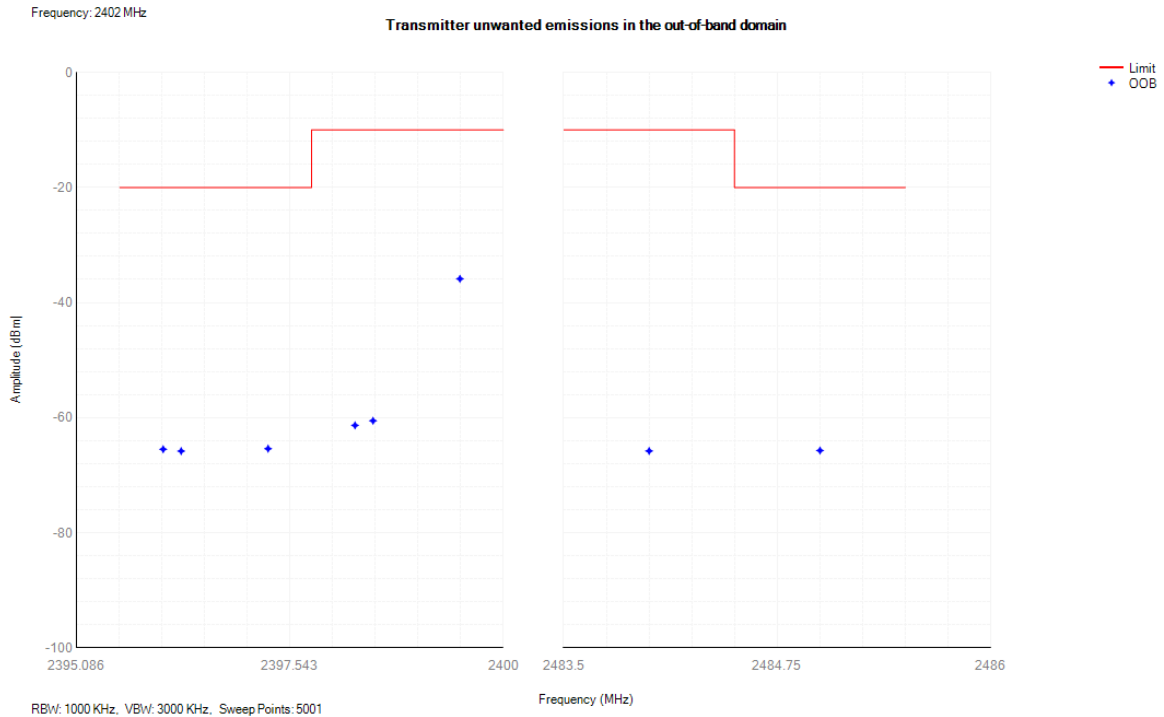
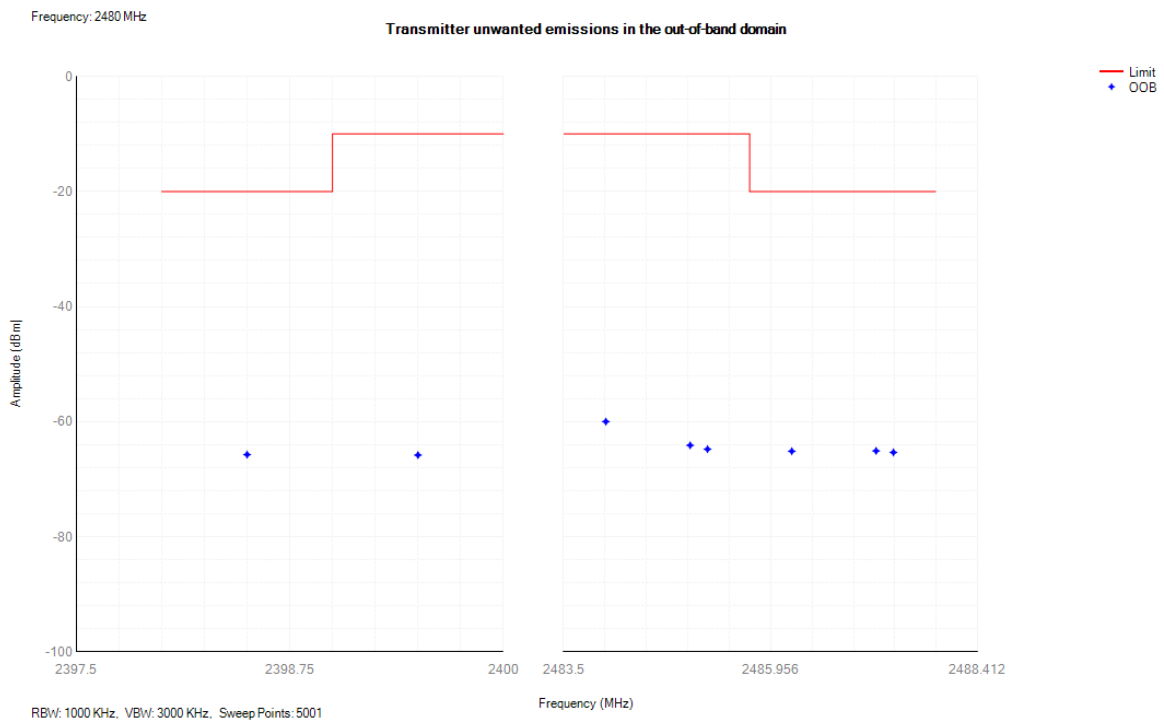
**Tx. Emissions OOB NVNT BLE 1M 2480MHz**

**Tx. Emissions OOB NVNT BLE 2M 2402MHz**

**Tx. Emissions OOB NVNT BLE 2M 2480MHz**

CO., LTD

## 12. Transmitter Unwanted Emissions In The Spurious Domain

### 12.1 Block Diagram Of Test Setup

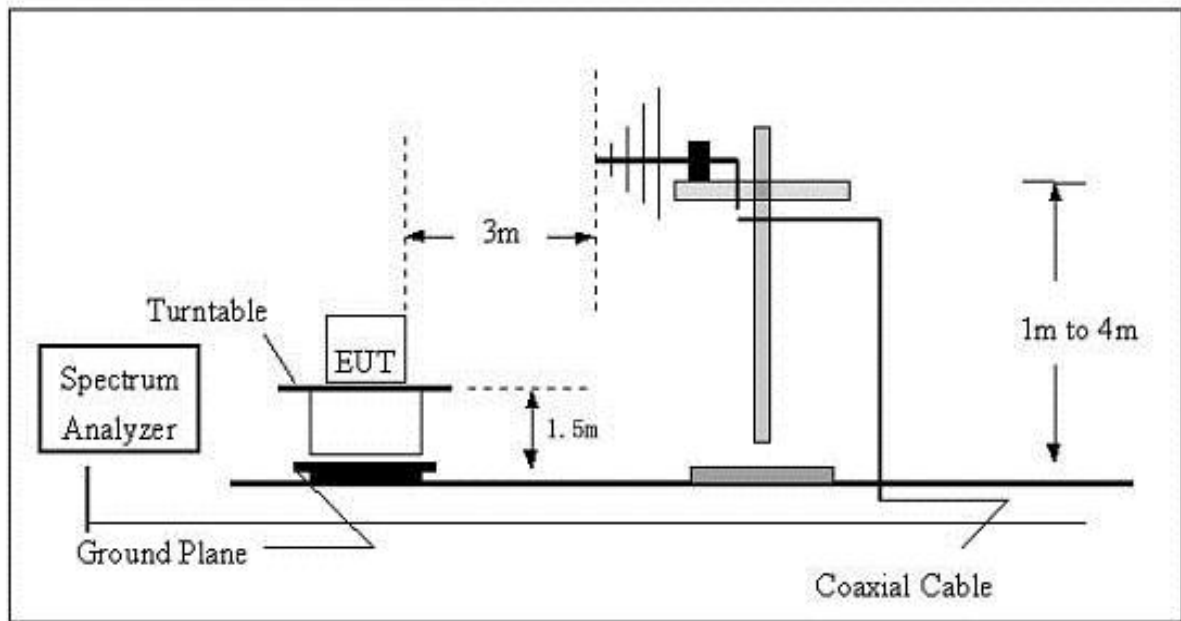
(A) Radiated Emission Test Set-Up Frequency Below 1GHz.



(B) Radiated Emission Test Set-Up Frequency Above 1GHz.

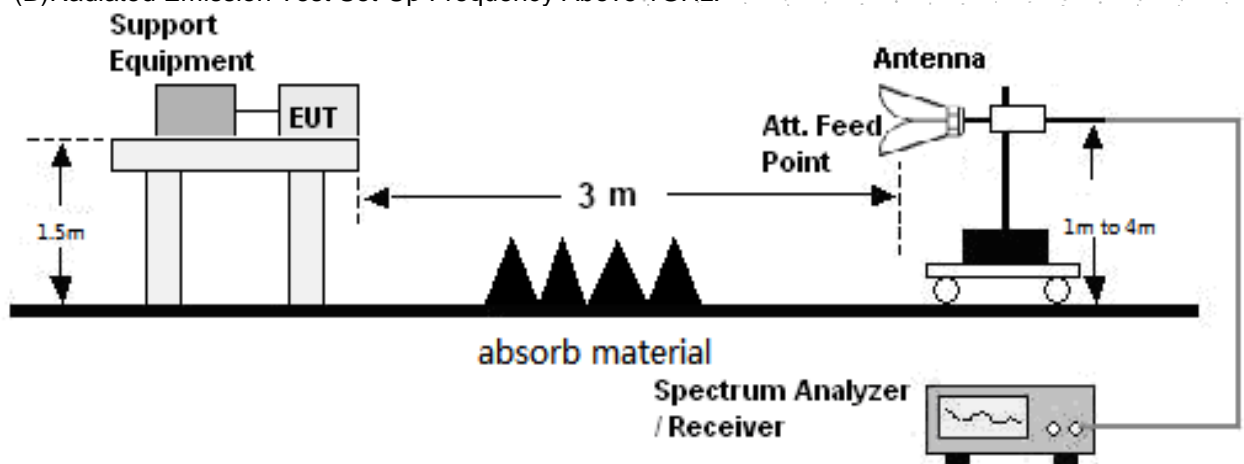

## 12.2 Limits

Frequency range	Maximum power, e.r.p. ( $\leq 1$ GHz) e.i.r.p. ( $> 1$ GHz)	Bandwidth
30 MHz to 47 MHz	-36 dBm	100 kHz
47 MHz to 74 MHz	-54 dBm	100 kHz
74 MHz to 87,5 MHz	-36 dBm	100 kHz
87,5 MHz to 118 MHz	-54 dBm	100 kHz
118 MHz to 174 MHz	-36 dBm	100 kHz
174 MHz to 230 MHz	-54 dBm	100 kHz
230 MHz to 470 MHz	-36 dBm	100 kHz
470 MHz to 694 MHz	-54 dBm	100 kHz
694 MHz to 1 GHz	-36 dBm	100 kHz
1 GHz to 12,75 GHz	-30 dBm	1 MHz

## 12.3 Test Procedure

### 30MHz ~ 1GHz:

- The Product was placed on the nonconductive turntable 1.5m above the ground in a full anechoic chamber.
- Set the spectrum analyzer/receiver in Peak detector, Max Hold mode, and 120 kHz RBW. Record the maximum field strength of all the pre-scan process in the full band when the antenna is varied between 1~4 m in both horizontal and vertical, and the turntable is rotated from 0 to 360 degrees.
- For each frequency whose maximum record was higher or close to limit, measure its QP value: vary the antenna's height and rotate the turntable from 0 to 360 degrees to find the height and degree where Product radiated the maximum emission, then set the test frequency analyzer/receiver to QP Detector and specified bandwidth with Maximum Hold Mode, and record the maximum value.

### Above 1GHz:

- The Product was placed on the non-conductive turntable 1.5 m above the ground in a full anechoic chamber..
- Set the spectrum analyzer/receiver in Peak detector, Max Hold mode, and 1MHz RBW. Record the maximum field strength of all the pre-scan process in the full band when the antenna is varied in both horizontal and vertical, and the turntable is rotated from 0 to 360 degrees.
- For each frequency whose maximum record was higher or close to limit, measure its AV value: rotate the turntable from 0 to 360 degrees to find the degree where Product radiated the maximum emission, then set the test frequency analyzer/receiver to AV value and specified bandwidth with Maximum Hold Mode, and record the maximum value.



## 12.4 Test Results

Modulation : GFSK 1Mbps (the worst data)

Frequency	Receiver Reading	Turn table Angle	RX Antenna		Correct	Absolute Level	Result	
			Height	Polar	Factor		Limit	Margin
(MHz)	(dBm)	Degree	(m)	(H/V)	(dBm)	(dBm)	(dBm)	(dB)
GFSK low channel								
561.69	-53.83	85	1.4	H	-7.39	-61.21	-54	-7.21
561.69	-52.21	98	1.7	V	-7.39	-59.59	-54	-5.59
4804.00	-40.97	240	1.3	H	-0.43	-41.40	-30	-11.40
4804.00	-40.38	50	1.9	V	-0.43	-40.81	-30	-10.81
7206.00	-56.33	338	1.4	H	8.31	-48.02	-30	-18.02
7206.00	-61.50	343	1.1	V	8.31	-53.19	-30	-23.19
GFSK Mid channel								
561.69	-54.20	234	1.7	H	-7.39	-61.59	-54	-7.59
561.69	-52.45	105	1.2	V	-7.39	-59.84	-54	-5.84
4880.00	-40.39	243	1.9	H	-0.38	-40.77	-30	-10.77
4880.00	-41.07	49	1.6	V	-0.38	-41.45	-30	-11.45
7320.00	-56.91	125	1.2	H	8.83	-48.08	-30	-18.08
7320.00	-61.01	322	1.7	V	8.83	-52.18	-30	-22.18
GFSK high channel								
561.69	-53.33	327	1.1	H	-7.39	-60.71	-54	-6.71
561.69	-52.34	341	1.5	V	-7.39	-59.73	-54	-5.73
4960.00	-40.21	182	1.6	H	-0.32	-40.53	-30	-10.53
4960.00	-41.33	66	1.4	V	-0.32	-41.65	-30	-11.65
7440.00	-56.29	298	1.3	H	9.35	-46.94	-30	-16.94
7440.00	-60.69	81	1.4	V	9.35	-51.34	-30	-21.34

Remark:

 $Absolute\ Level = Receiver\ Reading + Factor$ 
 $Factor = Antenna\ Factor + Cable\ Loss - Pre-amplifier.$ 

 BCTC  
 3C  
 PPR  
 检测



### 13. Receiver Spurious Emissions

#### 13.1 Block Diagram Of Test Setup

(A) Radiated Emission Test Set-Up Frequency Below 1GHz.

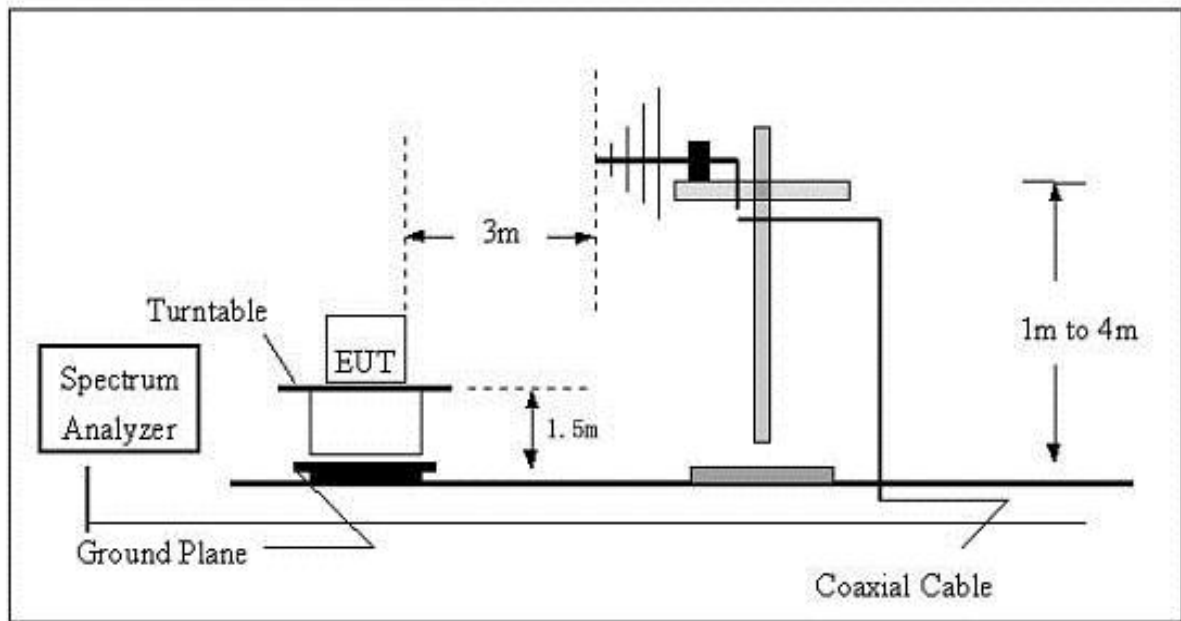

(B) Radiated Emission Test Set-Up Frequency Above 1GHz.

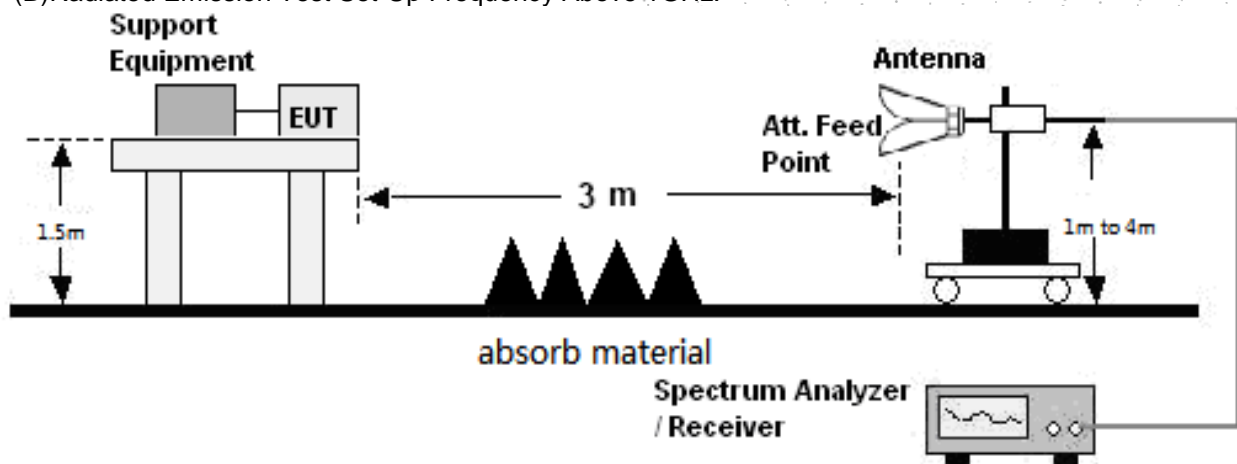

#### 13.2 Limits

Frequency(MHz)	Limit	Bandwidth
30-1000	-57dBm	100 kHz
1000-12750	-47dBm	1 MHz



### 13.3 Test Procedure

**30MHz ~ 1GHz:**

- a. The Product was placed on the nonconductive turntable 1.5m above the ground in a full anechoic chamber.
- b. Set the spectrum analyzer/receiver in Peak detector, Max Hold mode, and 120 kHz RBW. Record the maximum field strength of all the pre-scan process in the full band when the antenna is varied between 1~4 m in both horizontal and vertical, and the turntable is rotated from 0 to 360 degrees.
- c. For each frequency whose maximum record was higher or close to limit, measure its QP value: vary the antenna's height and rotate the turntable from 0 to 360 degrees to find the height and degree where Product radiated the maximum emission, then set the test frequency analyzer/receiver to QP Detector and specified bandwidth with Maximum Hold Mode, and record the maximum value.

**Above 1GHz:**

- a. The Product was placed on the non-conductive turntable 1.5 m above the ground in a full anechoic chamber..
- b. Set the spectrum analyzer/receiver in Peak detector, Max Hold mode, and 1MHz RBW. Record the maximum field strength of all the pre-scan process in the full band when the antenna is varied in both horizontal and vertical, and the turntable is rotated from 0 to 360 degrees.
- c. For each frequency whose maximum record was higher or close to limit, measure its AV value: rotate the turntable from 0 to 360 degrees to find the degree where Product radiated the maximum emission, then set the test frequency analyzer/receiver to AV value and specified bandwidth with Maximum Hold Mode, and record the maximum value.

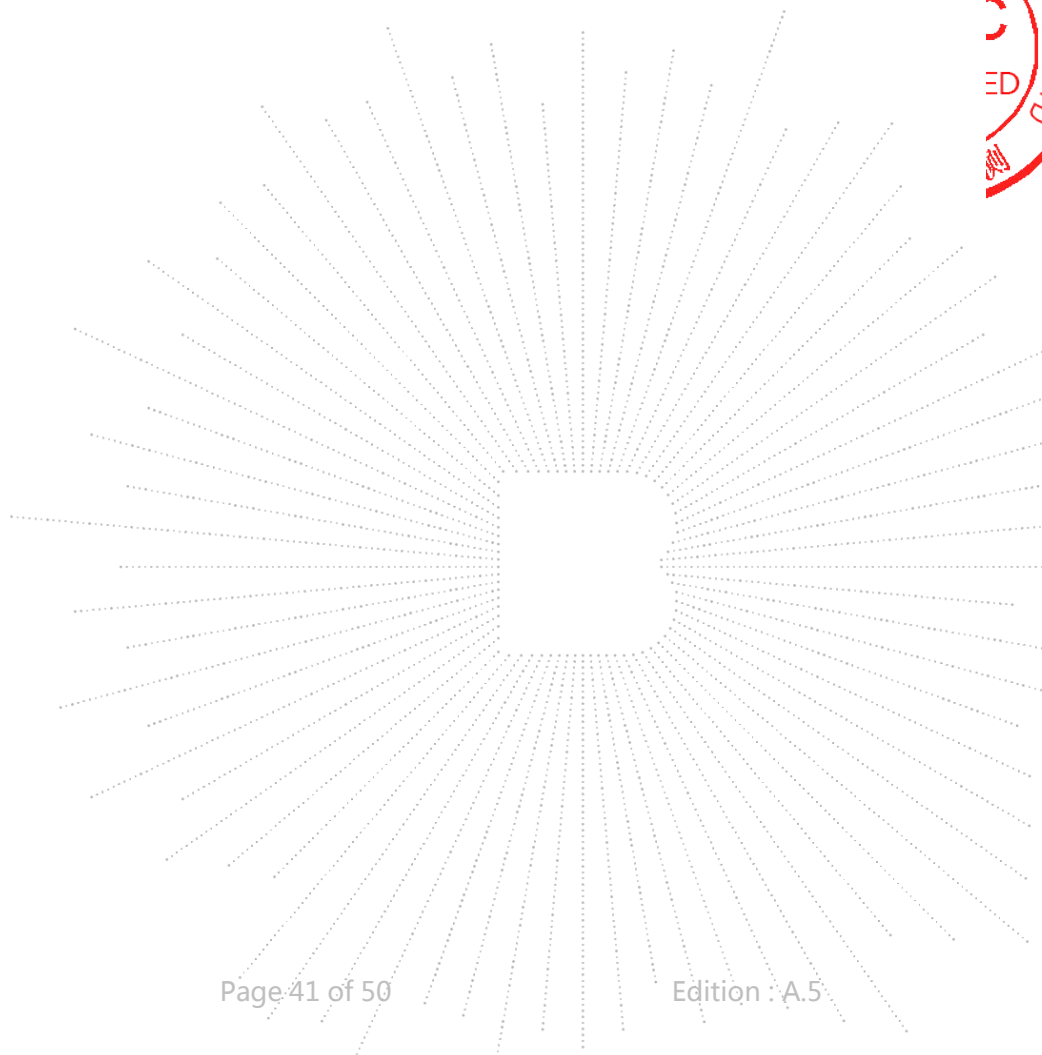

### 13.4 Test Results

Modulation : GFSK 1Mbps (the worst data)

Frequency (MHz)	Receiver Reading (dBm)	Turn table Angle Degree	RX Antenna		Correct	Absolute Level (dBm)	Result	
			Height (m)	Polar (H/V)	Factor (dBm)		Limit (dBm)	Margin (dB)
GFSK low channel								
372.11	-52.20	331	1.6	H	-11.71	-63.91	-57.00	-6.91
372.11	-52.53	297	1.5	V	-11.71	-64.25	-57.00	-7.25
2490.70	-51.44	41	1.5	H	-4.06	-55.50	-47.00	-8.50
2490.70	-54.16	24	1.9	V	-4.06	-58.22	-47.00	-11.22
GFSK Mid channel								
372.11	-51.65	103	1.1	H	-11.71	-63.36	-57.00	-6.36
372.11	-53.02	199	1.3	V	-11.71	-64.74	-57.00	-7.74
2490.70	-50.68	98	1.5	H	-4.06	-54.74	-47.00	-7.74
2490.70	-53.59	31	1.5	V	-4.06	-57.65	-47.00	-10.65
GFSK high channel								
372.11	-51.97	190	1.2	H	-11.71	-63.69	-57.00	-6.69
372.11	-53.06	190	1.5	V	-11.71	-64.77	-57.00	-7.77
2490.70	-50.82	292	1.1	H	-4.06	-54.88	-47.00	-7.88
2490.70	-54.76	186	1.7	V	-4.06	-58.82	-47.00	-11.82

Remark:

$$\text{Absolute Level} = \text{Receiver Reading} + \text{Factor}$$

$$\text{Factor} = \text{Antenna Factor} + \text{Cable Loss} - \text{Pre-amplifier.}$$

## 14. Receiver Blocking

### 14.1 Block Diagram Of Test Setup

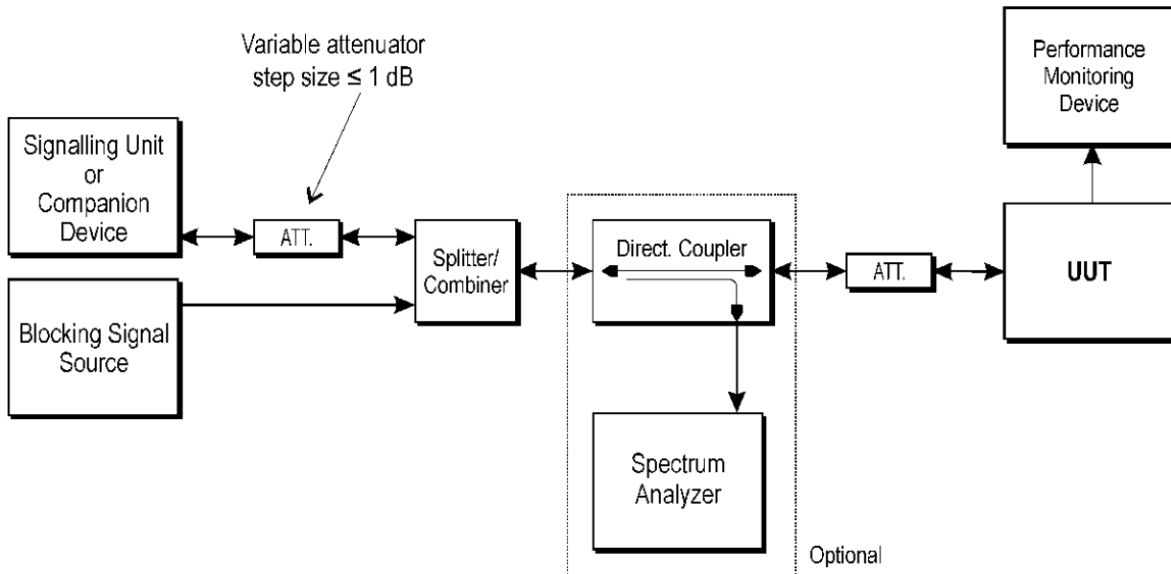

### 14.2 Limit

**Table 7: Receiver Blocking parameters receiver Category 2 equipment**

Wanted signal mean power from companion device (dBm) (see notes 1 and 3)	Blocking signal frequency (MHz)	Blocking signal power (dBm) (see note 3)	Type of blocking signal
$(-139 \text{ dBm} + 10 \times \log_{10}(\text{OCBW}) + 10 \text{ dB})$ or $(-74 \text{ dBm} + 10 \text{ dB})$ whichever is less (see note 2)	2 380 2 504 2 300 2 584	-34	CW
NOTE 1: OCBW is in Hz. NOTE 2: In case of radiated measurements using a companion device and the level of the wanted signal from the companion device cannot be determined, a relative test may be performed using a wanted signal up to $P_{\min} + 26 \text{ dB}$ where $P_{\min}$ is the minimum level of wanted signal required to meet the minimum performance criteria as defined in clause 4.3.1.12.3 in the absence of any blocking signal. NOTE 3: The level specified is the level at the UUT receiver input assuming a 0 dBi antenna assembly gain. In case of conducted measurements, this level has to be corrected for the (in-band) antenna assembly gain (G). In case of radiated measurements, this level is equivalent to a power flux density (PFD) in front of the UUT antenna with the UUT being configured/positioned as recorded in clause 5.4.3.2.2.			

### 14.3 Test Procedure

Refer to ETSI EN 300 328 V2.2.2 (2019-07) Clause 5.4.11.2.

### 14.4 Test Result

Modulation : GFSK (the worst data)

Receiver Category 2					
GFSK	Wanted Signal Power(dBm)	Blocking Frequency(MHz)	Blocking Power(dB)	Measured PER(%)	Limit (%)
2402	-68.76	2380	-34	1.78	10
2402	-68.76	2300	-34	4.19	10
2480	-68.76	2504	-34	3.25	10
2480	-68.76	2584	-34	2.60	10

Note: This report only shows the worst case test data.  
 OCBW=1056000Hz  
 $(-139\text{dBm} + 10 \cdot \log_{10}(\text{OCBW}) + 10\text{dB}) = -68.76\text{dBm}$   
 $(-74\text{dBm} + 10\text{dB}) = -64\text{dBm}$   
 $-68.76\text{dBm} \leq -64\text{dBm}$   
 Wanted Signal Power= -68.76dBm

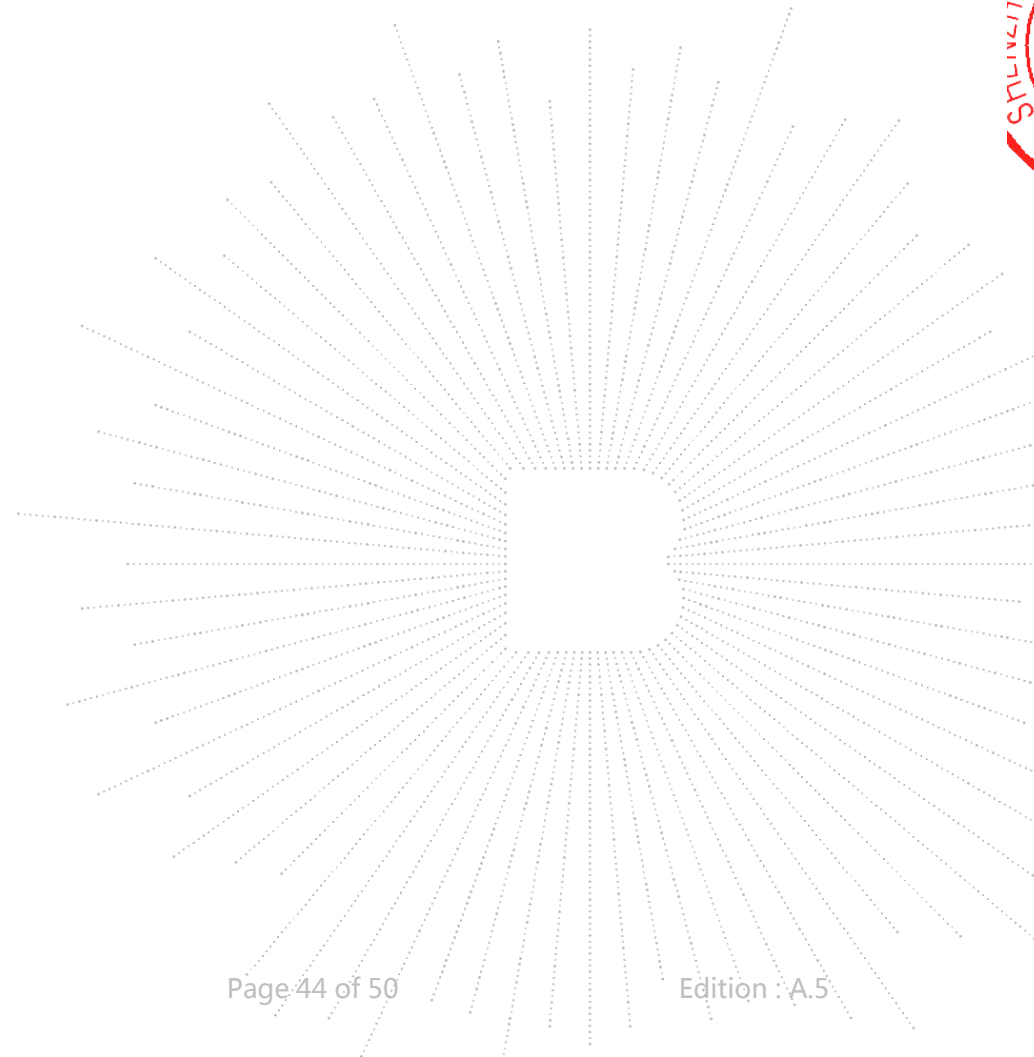



### 15. EUT Photographs

EUT Photo 1



EUT Photo 2



BCTC  
B  
AP  
停

EUT Photo 3

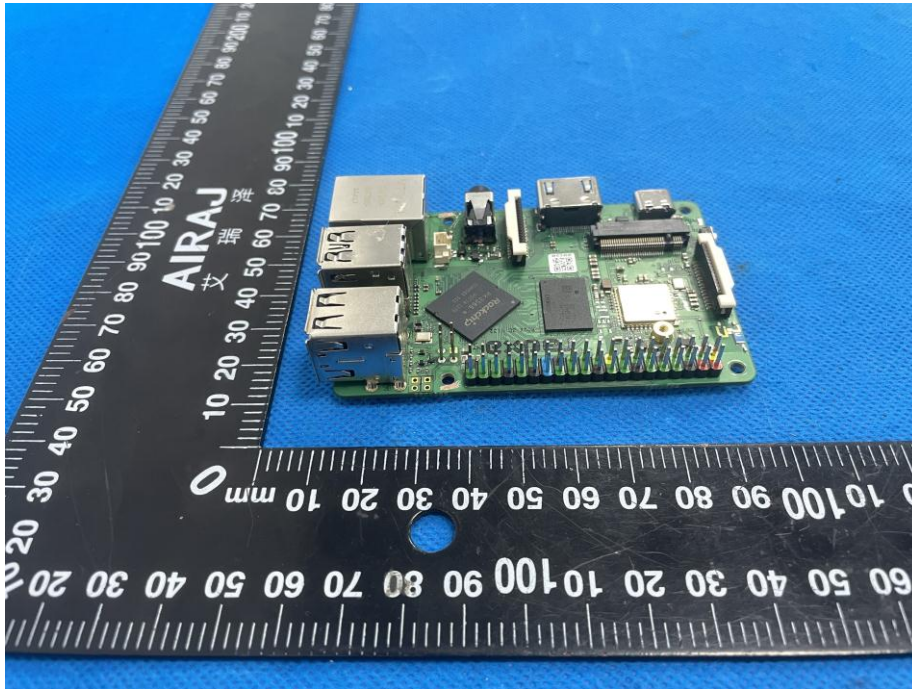

EUT Photo 4

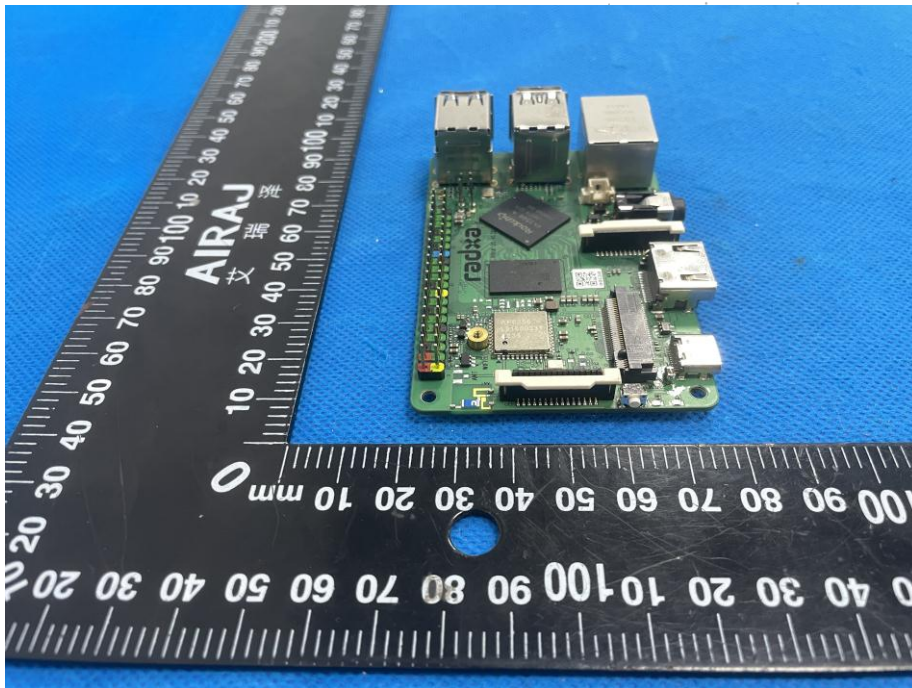

IC  
C  
PR  
测



EUT Photo 5

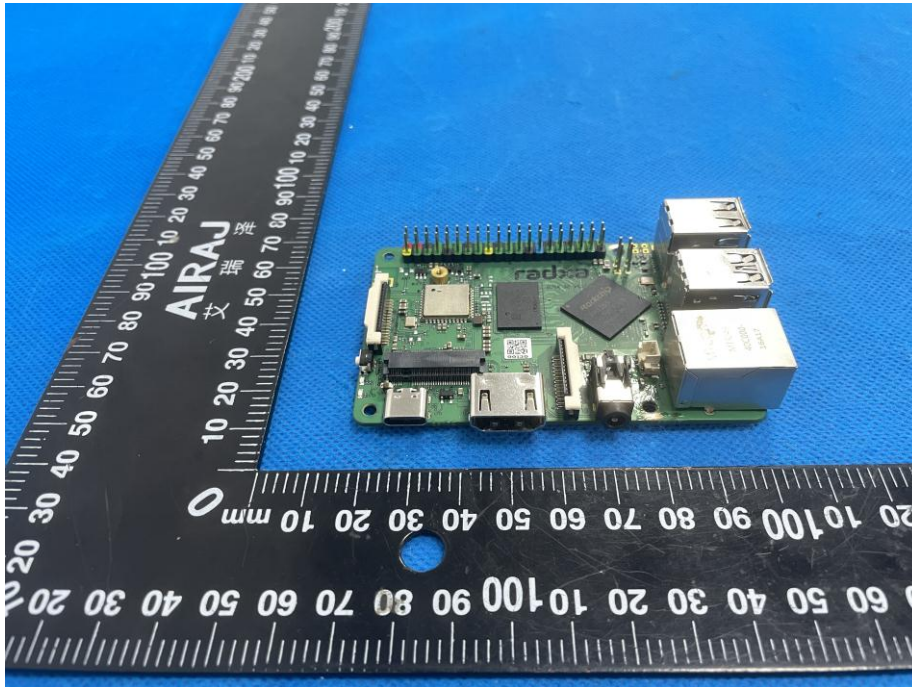

EUT Photo 6

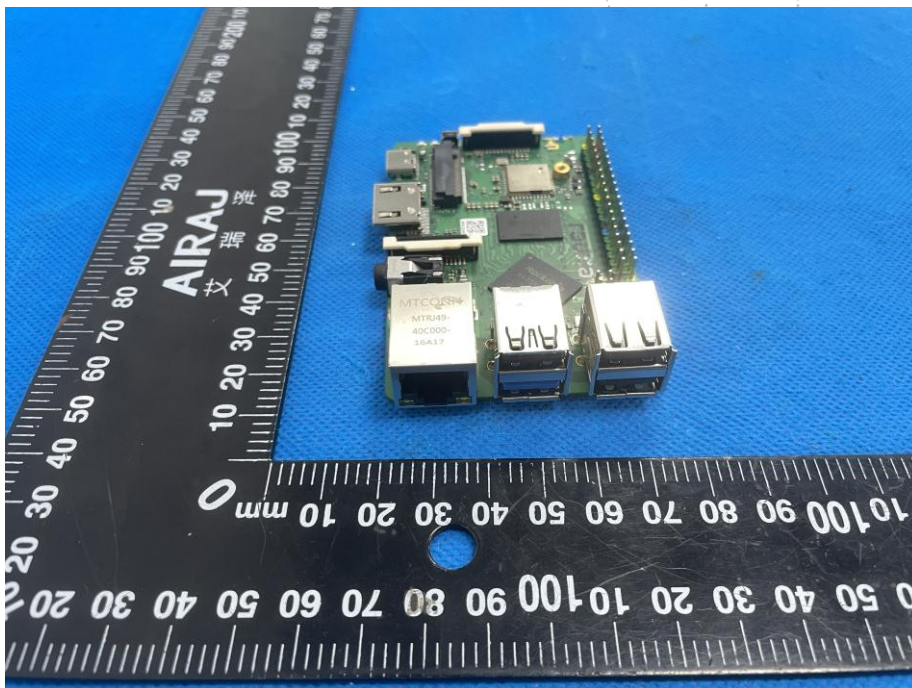

TE  
T  
OV  
檢

EUT Photo 7

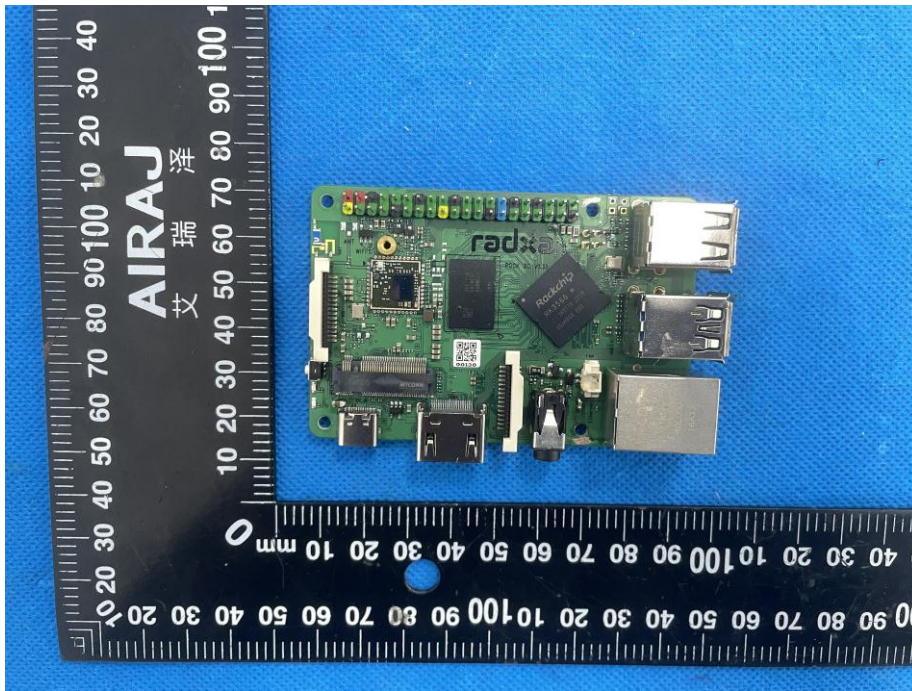

EUT Photo 8

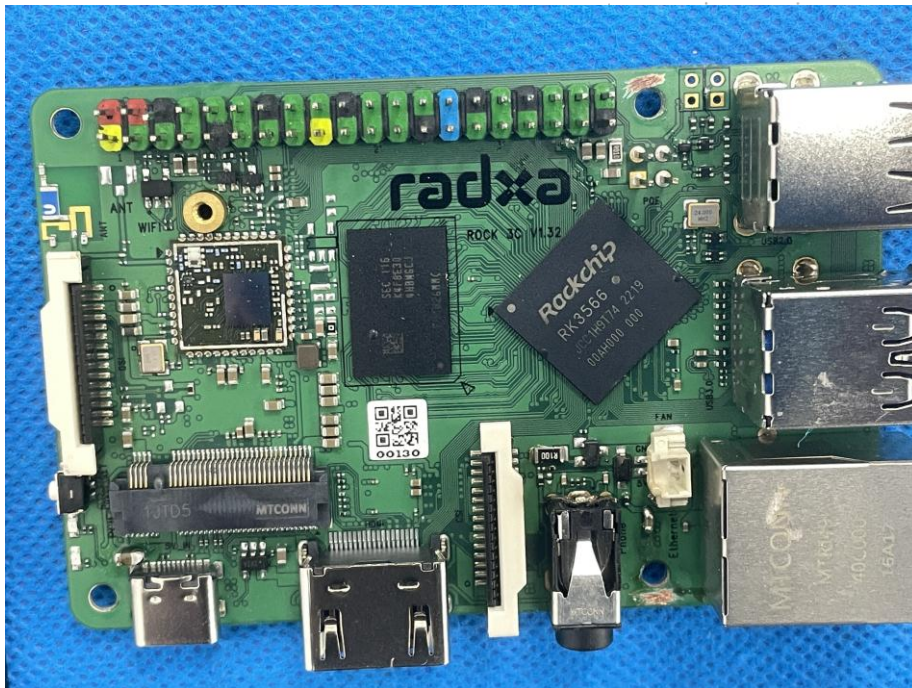

ST  
C  
ED  
测



## 16. EUT Test Setup Photographs

Spurious emissions



**STATEMENT**

1. The equipment lists are traceable to the national reference standards.
2. The test report can not be partially copied unless prior written approval is issued from our lab.
3. The test report is invalid without the "special seal for inspection and testing".
4. The test report is invalid without the signature of the approver.
5. The test process and test result is only related to the Unit Under Test.
6. Sample information is provided by the client and the laboratory is not responsible for its authenticity.
7. The test report without CMA mark is only used for scientific research, teaching, enterprise product development and internal quality control purposes.
8. The quality system of our laboratory is in accordance with ISO/IEC17025.
9. If there is any objection to this test report, the client should inform issuing laboratory within 15 days from the date of receiving test report.

**Address:**

1-2/F., Building B, Pengzhou Industrial Park, No.158, Fuyuan 1st Road, Zhancheng, Fuhai Subdistrict, Bao'an District, Shenzhen, Guangdong, China

TEL : 400-788-9558

P.C.: 518103

FAX : 0755-33229357

Website : <http://www.chnbctc.com>

E-Mail : [bctc@bctc-lab.com.cn](mailto:bctc@bctc-lab.com.cn)

\*\*\*\*\* **END** \*\*\*\*\*

2017