

TEST REPORT

Report No.: BCTC2408996918-6E

Applicant: Radxa Computer (Shenzhen) Co.,Ltd.

Product Name: Radxa ROCK 5C

Test Model: Radxa ROCK 5C D16R26

Tested Date: 2024-08-21 to 2024-08-30

Issued Date: 2024-09-12

Shenzhen BCTC Testing Co., Ltd.



Product Name: Radxa ROCK 5C

Trademark: 
Radxa ROCK 5C D16R26

Model/Type reference: Radxa ROCK 5C D1R26, Radxa ROCK 5C D2R26, Radxa ROCK 5C D4R26,
Radxa ROCK 5C D8R26, Radxa ROCK 5C D32R26, Radxa ROCK 5C D1R27,
Radxa ROCK 5C D2R27, Radxa ROCK 5C D4R27, Radxa ROCK 5C D8R27,
Radxa ROCK 5C D16R27, Radxa ROCK 5C D32R27

Prepared For: Radxa Computer (Shenzhen) Co.,Ltd.

Address: 1602, Smart Valley, tiezai Road, Gongle community, Xixiang, Baoan, Shenzhen

Manufacturer: Radxa Computer (Shenzhen) Co.,Ltd.

Address: 1602, Smart Valley, tiezai Road, Gongle community, Xixiang, Baoan, Shenzhen

Prepared By: Shenzhen BCTC Testing Co., Ltd.

Address: 1-2/F., Building B, Pengzhou Industrial Park, No.158, Fuyuan 1st Road, Zhancheng,
Fuhai Subdistrict, Bao'an District, Shenzhen, Guangdong, China

Sample Received Date: 2024-08-21

Sample tested Date: 2024-08-21 to 2024-08-30

Issue Date: 2024-09-12

Report No.: BCTC2408996918-6E

Test Standards ETSI EN 301 893 V2.1.1 (2017-05)

Test Results PASS

Remark: This is WIFI-5.1GHz band radio test report.

Tested by:

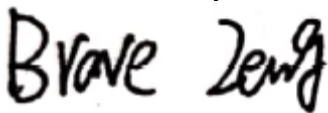

Brave Zeng/ Project Handler

Approved by:



Zero Zhou/Reviewer

The test report is effective only with both signature and specialized stamp. This result(s) shown in this report refer only to the sample(s) tested. Without written approval of Shenzhen BCTC Testing Co., Ltd, this report can't be reproduced except in full. The tested sample(s) and the sample information are provided by the client.



Table Of Content

Test Report Declaration	Page
1. Version	5
2. Test Summary	6
3. Measurement Uncertainty	7
4. Product Information And Test Setup	8
4.1 Product Information.....	8
4.2 Test Setup Configuration	8
4.3 Support Equipment	9
4.4 Channel List	9
4.5 Test Mode	9
4.6 Test Environment.....	10
5. Test Facility And Test Instrument Used.....	11
5.1 Test Facility.....	11
5.2 Test Instrument Used.....	11
6. Information As Required.....	12
7. Nominal Centre Frequencies.....	14
7.1 Block Diagram Of Test Setup.....	14
7.2 Limit	14
7.3 Test Procedure	14
7.4 Test Result.....	15
8. Nominal Channel Bandwidth And Occupied Channel Bandwidth.....	19
8.1 Block Diagram Of Test Setup.....	19
8.2 Limit	19
8.3 Test Procedure	19
8.4 Test Result.....	20
9. RF Output Power, Transmit Power Control (TPC).....	31
9.1 Block Diagram Of Test Setup.....	31
9.2 Limit	31
9.3 Test Procedure	31
9.4 Test Result.....	32
10. Power Spectral Density	35
10.1 Block Diagram Of Test Setup.....	35
10.2 Limit	35
10.3 Test Procedure	35
10.4 Test Result.....	36
11. Transmitter Unwanted Emissions In The Spurious Domain	37
11.1 Block Diagram Of Test Setup.....	37
11.2 Limits.....	38
11.3 Test Procedure	38
11.4 Test Results	39
12. Transmitter Unwanted Emissions In The Out-Of-Band Domain	40
12.1 Block Diagram Of Test Setup.....	40
12.2 Limit	40
12.3 Test Procedure	40

BCTC
 BCTC
 PPR
 Report

12.4	Test Result.....	41
13.	Receiver Spurious Emissions.....	61
13.1	Block Diagram Of Test Setup.....	61
13.2	Limits.....	61
13.3	Test Procedure	62
13.4	Test Results	62
14.	Adaptivity.....	63
14.1	Block Diagram Of Test Setup.....	63
14.2	Limit	63
14.3	Test Procedure	64
14.4	Test Result.....	64
15.	Receiver Blocking.....	65
15.1	Block Diagram Of Test Setup.....	65
15.2	Limit	65
15.3	Test Procedure	66
15.4	Test Result.....	66
16.	EUT Photographs.....	67
17.	EUT Test Setup Photographs.....	68

(Note: N/A Means Not Applicable)

TEC
TC
OVB
t See

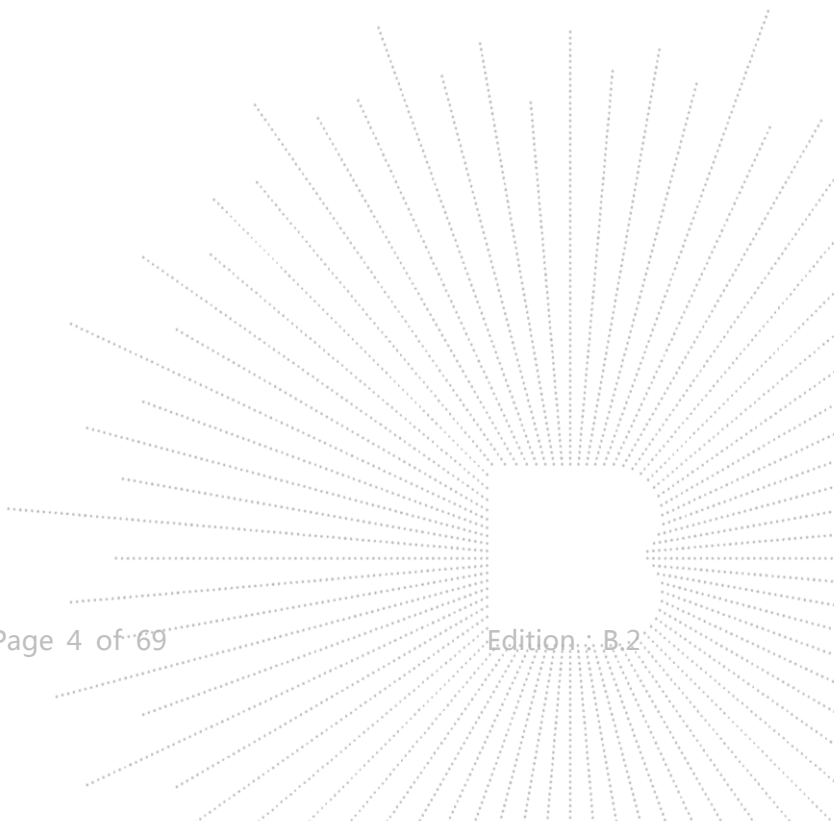

1. Version

Report No.	Issue Date	Description	Approved
BCTC2408996918-6E	2024-09-12	Original	Valid

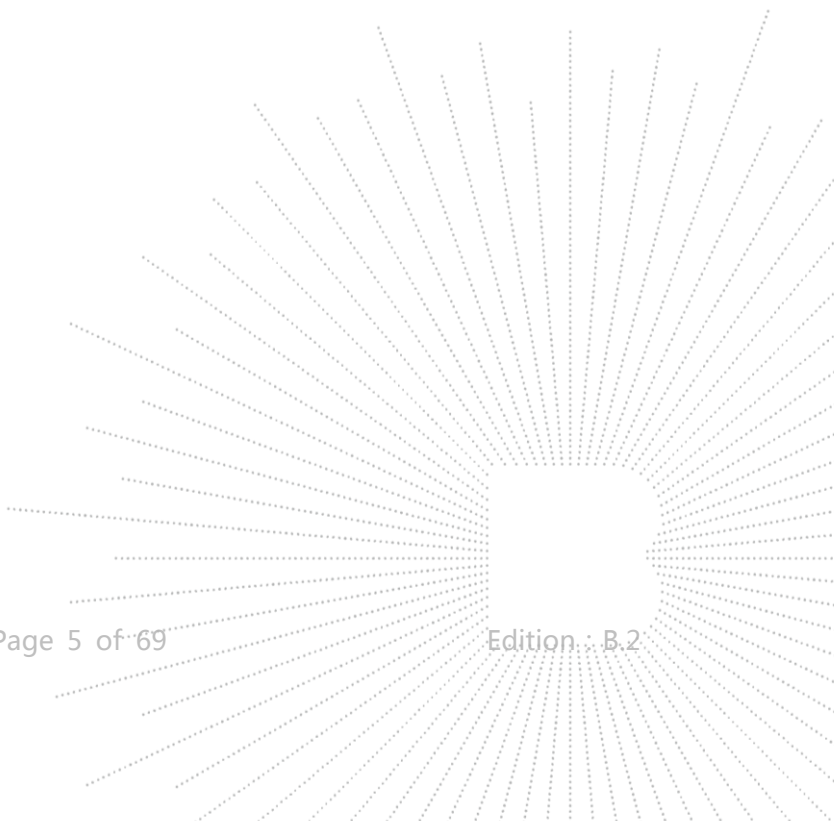

2. Test Summary

The Product has been tested according to the following specifications:

No.	Test Parameter	Clause No.	Results
1	Nominal Centre frequencies	4.2.1	PASS
2	Nominal Channel Bandwidth and Occupied Channel Bandwidth	4.2.2	PASS
3	RF output power, Transmit Power Control (TPC) and Power Density	4.2.3	PASS
4	Transmitter unwanted emissions	4.2.4	PASS
5	Receiver spurious emissions	4.2.5	PASS
6	Dynamic Frequency Selection (DFS)	4.2.6	PASS
7	Adaptivity (Channel Access Mechanism)	4.2.7	PASS
8	Receiver Blocking	4.2.8	PASS
9	User Access Restrictions	4.2.9	PASS

Note: N/A is an abbreviation for Not Applicable and means this test item is not applicable for this device according to the technology characteristic of device.

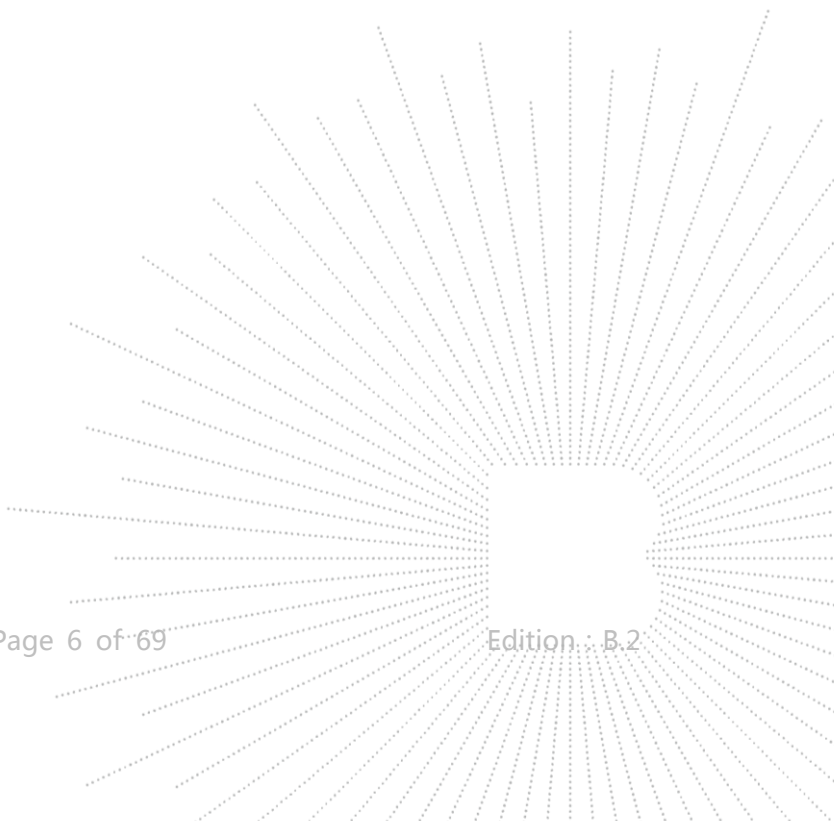
3. Measurement Uncertainty

Where relevant, the following measurement uncertainty levels have been estimated for tests performed on the Product as specified in CISPR 16-4-2. This uncertainty represents an expanded uncertainty expressed at approximately the 95% confidence level using a coverage factor of k=2.

RF frequency	1×10^{-7}
RF power, conducted	± 1.0 dB
Conducted emission of receivers	± 1 dB
Radiated emission of transmitter	± 6 dB
Radiated emission of receiver	± 6 dB
Temperature	± 1 degree
Humidity	± 5 %

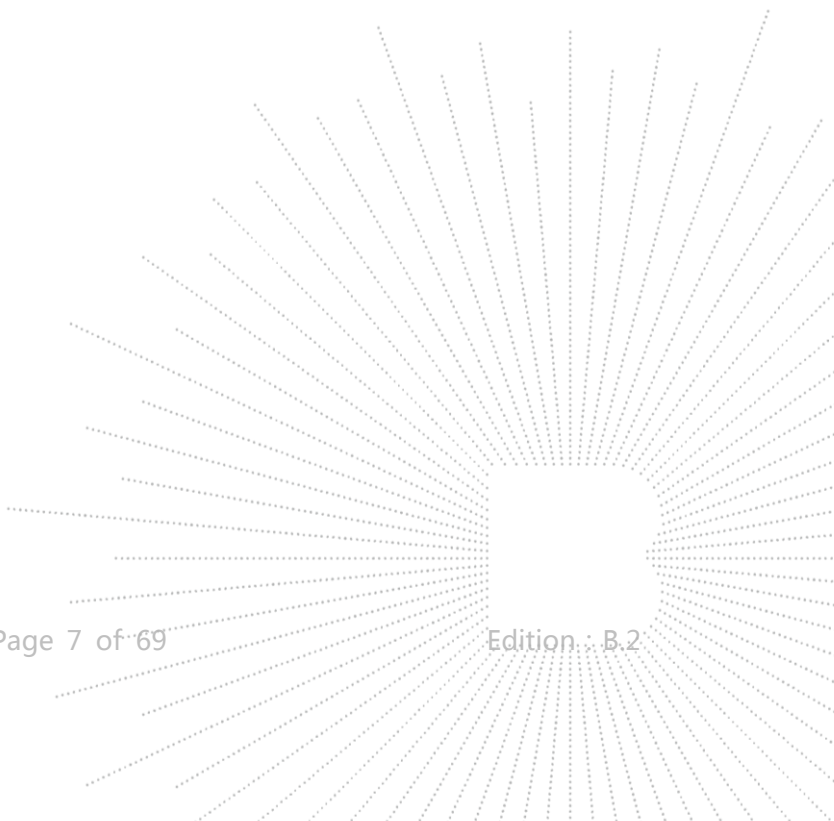

4. Product Information And Test Setup

4.1 Product Information

Model/Type reference	Radxa ROCK 5C D16R26 Radxa ROCK 5C D1R26, Radxa ROCK 5C D2R26, Radxa ROCK 5C D4R26, Radxa ROCK 5C D8R26, Radxa ROCK 5C D32R26, Radxa ROCK 5C D1R27, Radxa ROCK 5C D2R27, Radxa ROCK 5C D4R27, Radxa ROCK 5C D8R27, Radxa ROCK 5C D16R27, Radxa ROCK 5C D32R27
Model differences:	All models are the same circuit and RF module, only the model name and memory size and SoC differ.
Hardware Version:	N/A
Software Version:	N/A
Operation Frequency:	WIFI(5.1GHz): IEEE 802.11a/n/ac HT20/ax HT20:5180MHz-5240MHz IEEE 802.11n/ac HT40/ ax HT40:5190MHz-5230MHz IEEE 802.11ac HT80/ ax HT80:5210MHz
Max. RF output power:	WIFI(5.1GHz): 11.3 dBm
Type of Modulation:	WIFI(5.1GHz): OFDM-BPSK, QPSK, 16QAM, 64QAM, 256QAM
Antenna installation:	WIFI(5.1GHz): FPC antenna WIFI(5.1GHz):1.42 dBi
Antenna Gain:	Remark: <input type="checkbox"/> The antenna gain of the product comes from the antenna report provided by the customer, and the test data is affected by the customer information. <input checked="" type="checkbox"/> The antenna gain of the product is provided by the customer, and the test data is affected by the customer information.
Ratings:	DC 5V from adapter

Cable of Product

No.	Cable Type	Quantity	Provider	Length (m)	Shielded	Note
1	--	--	Applicant	---	No	With a ferrite ring in mid Detachable
2	--	--	BCTC	--	No	--

4.2 Test Setup Configuration

See test photographs attached in EUT TEST SETUP PHOTOGRAPHS for the actual connections between Product and support equipment.

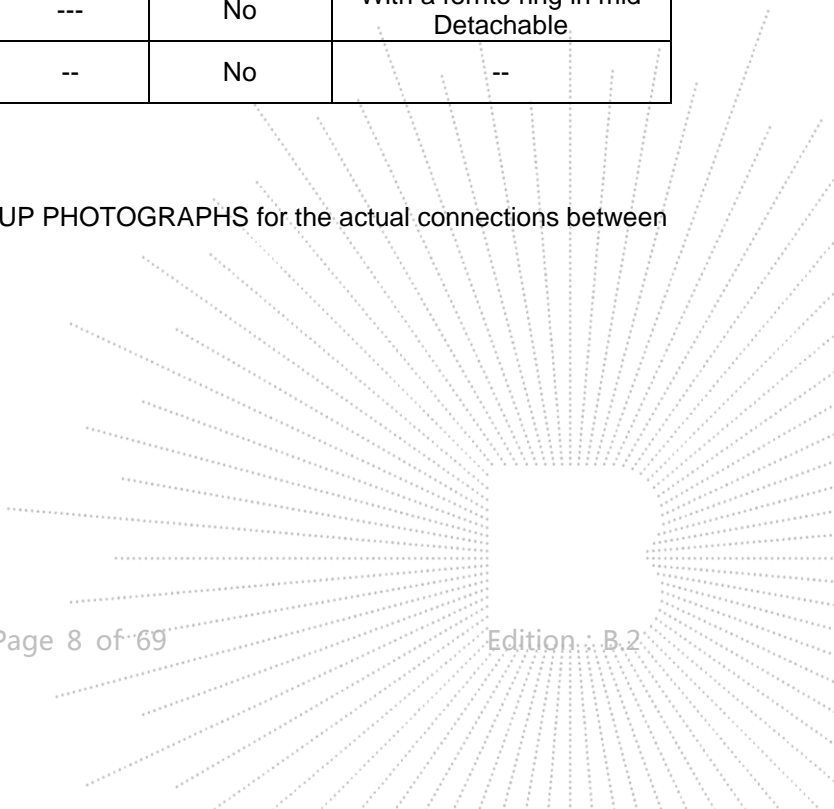

4.3 Support Equipment

No.	Device Type	Brand	Model	Series No.	Note
1.	Adapter	HP	TPN-LA22	---	---
2.	keyboard	Logitech	1641MG01DLZ8	---	---
3.	Mouse	Logitech	M-U0026	---	---
4.	Earphone	IHIP	SBGE1	---	---
5.	U disk	SanDisk	32G	---	---
6.	Router	HUAWEI	WS318	---	---
7.	HDMI Cable	Belkin	HDMI2.0	---	---
8.	Display	ChangHong	55DBK	---	---

Notes:

1. All the equipment/cables were placed in the worst-case configuration to maximize the emission during the test.
2. Grounding was established in accordance with the manufacturer's requirements and conditions for the intended use.

4.4 Channel List

CH	Frequency (MHz)	CH	Frequency (MHz)	CH	Frequency (MHz)	CH	Frequency (MHz)
36	5180	38	5190	40	5200	42	5210
44	5220	46	5230	48	5240		

4.5 Test Mode

All test mode(s) and condition(s) mentioned were considered and evaluated respectively by performing full tests, the worst data were recorded and reported.

Test mode	Low channel	Middle channel	High channel
Transmitting(802.11a)	5180 MHz	5200 MHz	5240 MHz
Transmitting(802.11n HT20)	5180 MHz	5200 MHz	5240 MHz
Transmitting(802.11n HT40)	5190 MHz	/	5230 MHz
Transmitting(802.11ac HT20)	5180 MHz	5200 MHz	5240 MHz
Transmitting(802.11ac HT40)	5190 MHz	/	5230 MHz
Transmitting(802.11ac HT80)	/	5210 MHz	/
Transmitting(802.11ax HT20)	5180 MHz	5200 MHz	5240 MHz
Transmitting(802.11ax HT40)	5190 MHz	/	5230 MHz
Transmitting(802.11ax HT80)	/	5210 MHz	/
Receiving(802.11a)	5180 MHz	5200 MHz	5240 MHz
Receiving(802.11n HT20)	5180 MHz	5200 MHz	5240 MHz
Receiving(802.11n HT40)	5190 MHz	/	5230 MHz
Receiving(802.11ac HT20)	5180 MHz	5200 MHz	5240 MHz
Receiving(802.11ac HT40)	5190 MHz	/	5230 MHz
Receiving(802.11ac HT80)	/	5210 MHz	/
Receiving(802.11ax HT20)	5180 MHz	5200 MHz	5240 MHz
Receiving(802.11ax HT40)	5190 MHz	/	5230 MHz
Receiving(802.11ax HT80)	/	5210 MHz	/

4.6 Test Environment

1. Normal Test Conditions:

Humidity(%):	54
Atmospheric Pressure(kPa):	101
Temperature(°C):	26
Test Voltage(DC):	5V

2. Extreme Test Conditions:

For tests at extreme temperatures, measurements shall be made over the extremes of the operating temperature range as declared by the manufacturer.

Test Conditions	LT	HT
Temperature (°C)	0	35

TEC
TC
OVB
t See

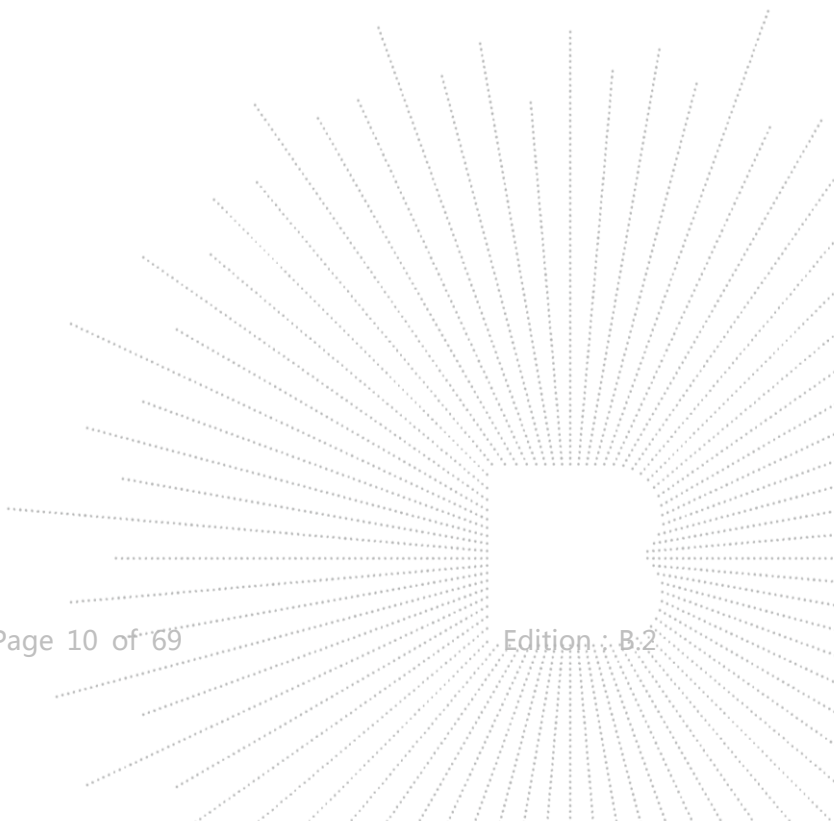

5. Test Facility And Test Instrument Used

5.1 Test Facility

All measurement facilities used to collect the measurement data are located at 1-2/F., Building B, Pengzhou Industrial Park, No.158, Fuyuan 1st Road, Zhancheng, Fuhai Subdistrict, Bao'an District, Shenzhen, Guangdong, China. The site and apparatus are constructed in conformance with the requirements of ANSI C63.4 and CISPR 16-1-1 other equivalent standards.

5.2 Test Instrument Used

Item	Equipment	Manufacturer	Type No.	Serial No.	Last calibration	Calibrated until
1	966 chamber	ChengYu	966 Room	966	May 15, 2023	May 14, 2026
2	Receiver	R&S	ESR3	102075	May 16, 2024	May 15, 2025
3	Receiver	R&S	ESRP	101154	May 16, 2024	May 15, 2025
4	Amplifier	Schwarzbeck	BBV9744	9744-0037	May 16, 2024	May 15, 2025
5	TRILOG Broadband Antenna	Schwarzbeck	VULB 9163	942	May 21, 2024	May 20, 2025
6	Loop Antenna	Schwarzbeck	FMZB1519B	00014	May 21, 2024	May 20, 2025
7	Amplifier	SKET	LAPA_01G18 G-45dB	SK2021040901	May 16, 2024	May 15, 2025
8	Horn Antenna	Schwarzbeck	BBHA9120D	1541	May 21, 2024	May 20, 2025
9	Preamplifier	MITEQ	TTA1840-35- HG	2034381	May 16, 2024	May 15, 2025
10	Horn antenna	Schwarzbeck	BBHA9170	00822	May 21, 2024	May 20, 2025
11	Spectrum Analyzer 9kHz-40GHz	R&S	FSP 40	100363	May 16, 2024	May 15, 2025
12	Software	Frad	EZ-EMC	FA-03A2 RE	\	\
13	Spectrum Analyzer	Keysight	N9020A	MY49100060	May 16, 2024	May 15, 2025
14	Signal Generator	Keysight	N5182B	MY56200519	May 16, 2024	May 15, 2025
15	Signal Generator	Keysight	83711B	US37100131	May 16, 2024	May 15, 2025
16	Communication test set	R&S	CMW500	126173	Nov. 13. 2023	Nov. 12, 2024
17	D.C. Power Supply	LongWei	TPR-6405D	\	Nov. 13. 2023	Nov. 12, 2024
18	Programmable constant temperature and humidity test chamber	DGBELL	BTKS5-150C	\	Jul. 01, 2024	Jun. 30, 2025
19	Radio frequency control box	MAIWEI	MW100-RFC B	\	\	\
20	Software	MAIWEI	MTS 8310	\	\	\

6. Information As Required

ETSI EN 301 893 V2.1.1 Annex G

a) The Nominal Channel Bandwidth(s):
Refer to section 4.4 channel list.
b) For Load Based Equipment that supports multi-channel operation:
N/A
c) The different transmit operating modes (see clause 5.3.3.2) (tick all that apply):
<input type="checkbox"/> Operating mode 1: Single Antenna Equipment
<input type="checkbox"/> a) Equipment with only 1 antenna
d) In case of Smart Antenna Systems or multiple antenna systems:
<ul style="list-style-type: none"> • The number of Receive chains: • The number of Transmit chains: • Equal power distribution among the transmit chains: <input type="checkbox"/> Yes <input type="checkbox"/> No • In case of beamforming, the maximum (additional) beamforming gain: Db NOTE: Beamforming gain does not include the basic gain of a single antenna (assembly).
e) TPC feature available:
<input type="checkbox"/> Yes <input checked="" type="checkbox"/> No
f) For equipment with TPC range:
The lowest and highest power level (or lowest and highest e.i.r.p. level in case of integrated antenna equipment), intended antenna assemblies and corresponding operating frequency range for the TPC range (or for each of the TPC ranges if more than one is implemented).
g) For equipment without a TPC range:
Power Setting 1: Max.
h) The DFS related operating mode(s) of the equipment:
N/A
i) User access restrictions (please check box below to confirm):
N/A
j) For equipment with Off-Channel CAC functionality:
N/A
k) The equipment can operate in ad-hoc mode:
N/A
l) Operating Frequency Range(s):
Refer to section 4.1.
m) The extreme operating temperature and supply voltage range that apply to the equipment:
Refer to section 4.6
n) The test sequence/test software used (see also ETSI EN 301 893 (V2.1.1), clause 5.3.1.2):
Provide by manufacturer.
o) Type of Equipment:
<input checked="" type="checkbox"/> Stand-alone
<input type="checkbox"/> Combined Equipment (Equipment where the radio part is fully integrated within another type of equipment)
<input type="checkbox"/> Plug-in radio device (Equipment intended for a variety of host systems)
<input type="checkbox"/> Other
p) Adaptivity (Channel Access Mechanism):
<input type="checkbox"/> Frame Based Equipment
<input checked="" type="checkbox"/> Load Based Equipment
q) With regards to Adaptivity for Frame Based Equipment
<input type="checkbox"/> The Frame Based Equipment operates as an Initiating Device
<input type="checkbox"/> The Frame Based Equipment operates as an Responding Device
<input type="checkbox"/> The Frame Based Equipment can operate as an Initiating Device and as a Responding Device
r) With regards to Adaptivity for Load Based Equipment
N/A
s) The equipment supports a geo-location capability as defined in clause 4.2.10 of ETSI EN 301 893 V2.1.1:

CO.LTD

Yes No

t) The minimum performance criteria (see ETSI EN 301 893 V2.1.1, clause 4.2.8.3) that corresponds to the intended use of the equipment:

The minimum performance criterion is a PER of less than or equal to 10 %.

u) The theoretical maximum radio performance of the equipment (e.g. maximum throughput) (see ETSI EN 301 893 V2.1.1, clause 5.4.9.3.1):

N/A

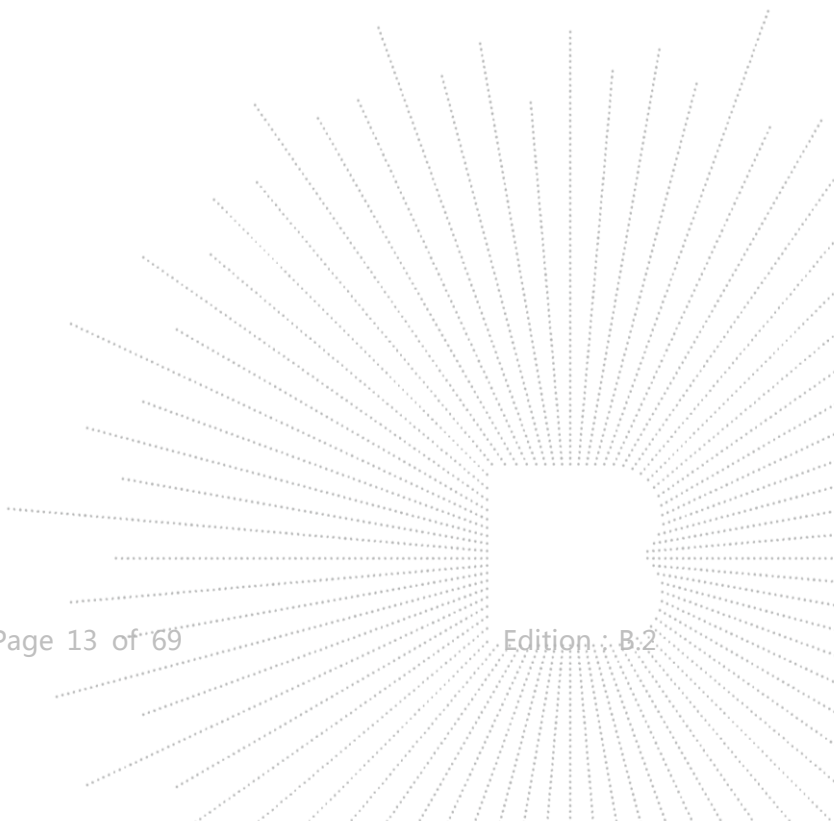

7. Nominal Centre Frequencies

7.1 Block Diagram Of Test Setup

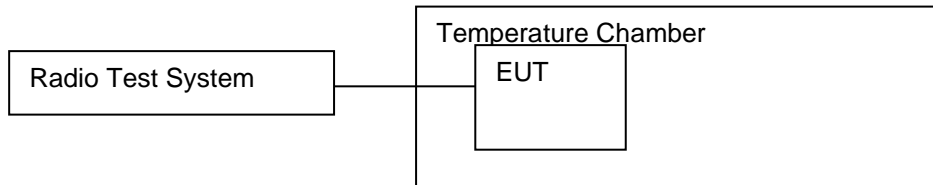

7.2 Limit

The Nominal Centre Frequencies (f_c) for a Nominal Channel Bandwidth of 20 MHz are defined by equation (1). See also figure 3.

$f_c = 5\,160 + (g \times 20)$ MHz, where $0 \leq g \leq 9$ or $16 \leq g \leq 27$ and where g shall be an integer.

A maximum offset of the Nominal Centre Frequency of ± 200 kHz is permitted. Where the manufacturer decides to make use of this frequency offset, the manufacturer shall declare the actual centre frequencies used by the equipment.

See clause 5.4.1, item a).

The actual centre frequency for any given channel shall be maintained within the range $f_c \pm 20$ ppm.

Equipment may have simultaneous transmissions on more than one Operating Channel with a Nominal Channel Bandwidth of 20 MHz.

7.3 Test Procedure

This method is an alternative to the above method in case the UUT cannot be operated in an un-modulated mode.

The UUT shall be connected to spectrum analyzer.

Max Hold shall be selected and the centre frequency adjusted to that of the UUT.

The peak value of the power envelope shall be measured and noted. The span shall be reduced and the marker moved in a positive frequency increment until the upper, (relative to the centre frequency), -10 dBc point is reached. This value shall be noted as f_1 .

The marker shall then be moved in a negative frequency increment until the lower, (relative to the centre frequency), -10 dBc point is reached. This value shall be noted as f_2 .

The centre frequency is calculated as $(f_1 + f_2) / 2$.



7.4 Test Result

Condition	Frequency (MHz)	Measured Frequency (MHz)	Frequency Error (Hz)	Deviation (ppm)	Limit (ppm)	Verdict
NVNT	5180	5179.957	-43000	-8.3	20	Pass
NVNT	5200	5199.9565	-43500	-8.37	20	Pass
NVNT	5240	5239.956	-44000	-8.4	20	Pass
NVNT	5190	5189.957	-43000	-8.29	20	Pass
NVNT	5230	5229.956	-44000	-8.41	20	Pass
NVNT	5210	5209.957	-43000	-8.25	20	Pass

BCTC
BCTC
PPR
Report

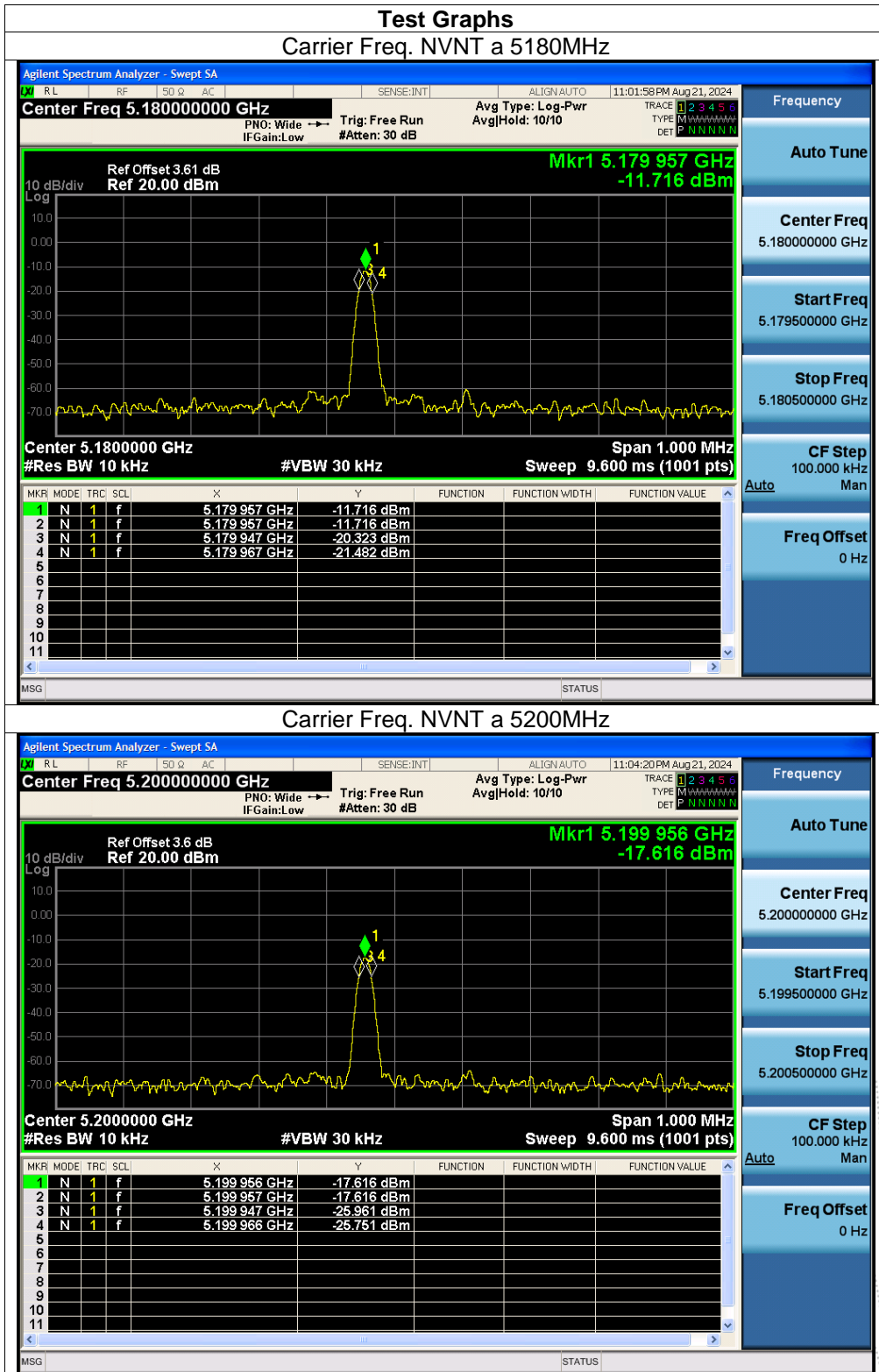

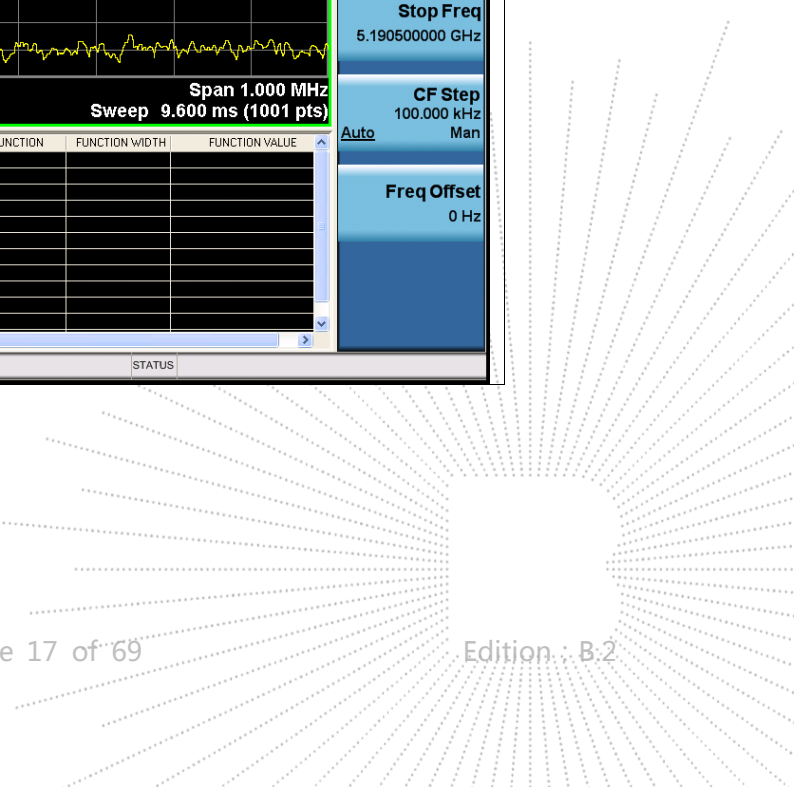
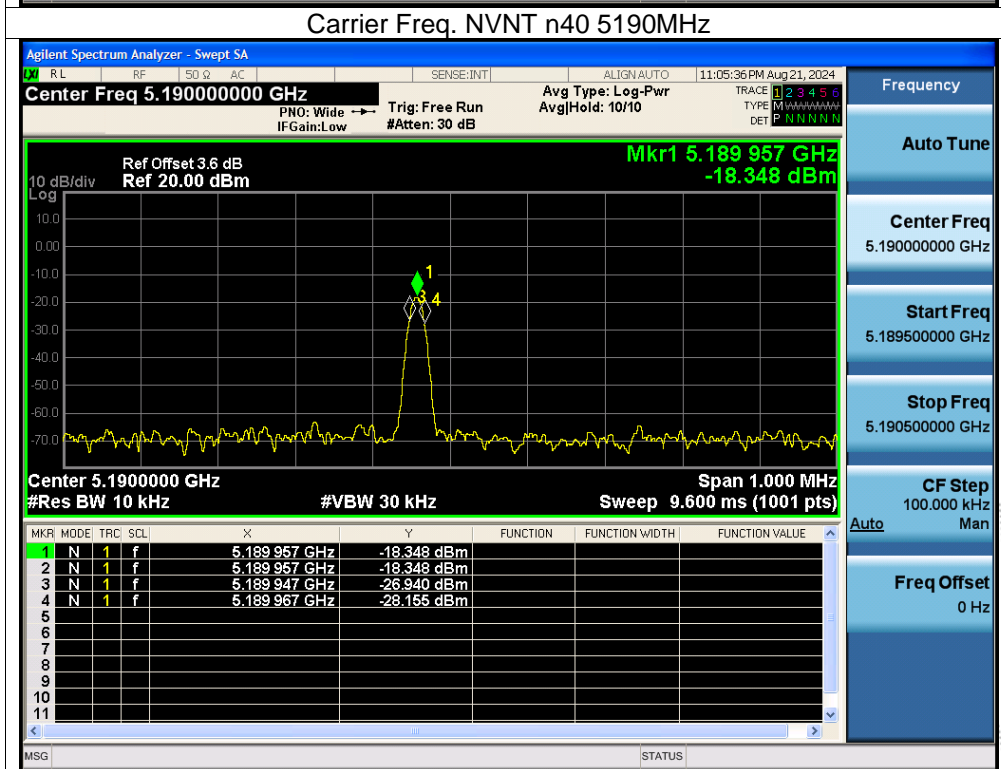
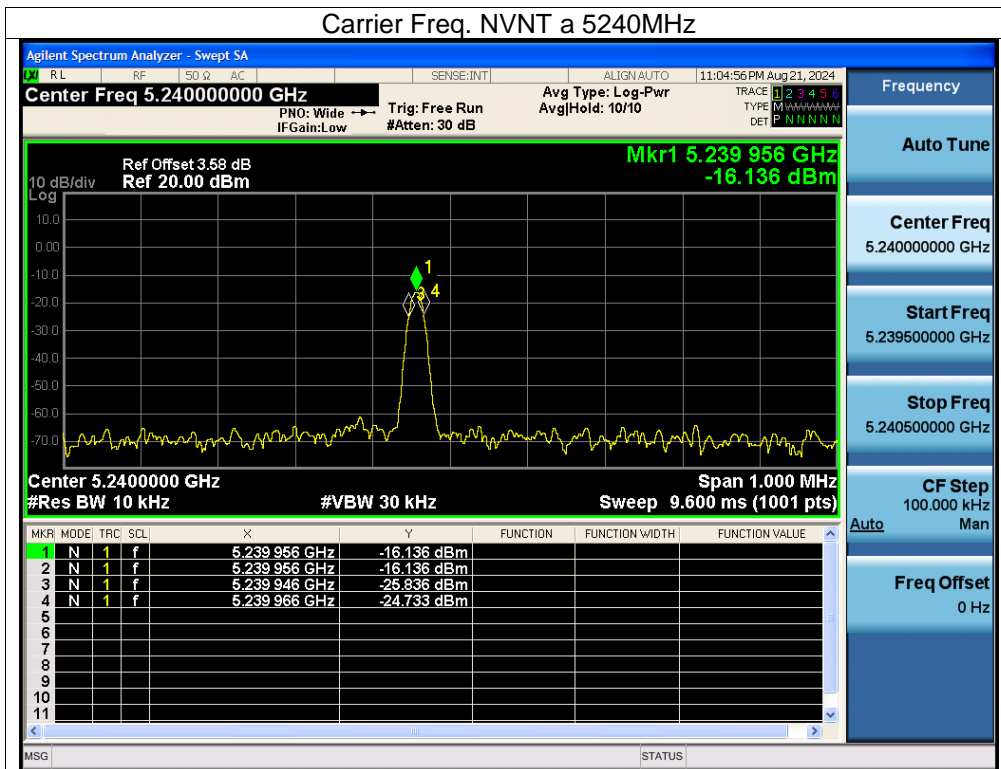

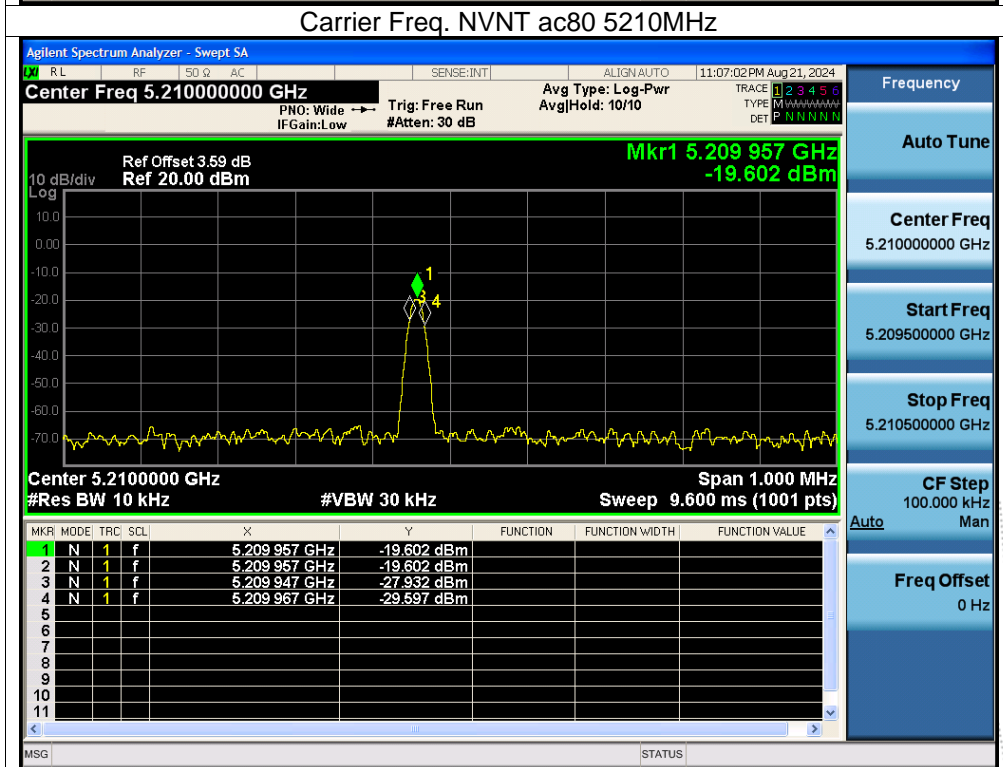
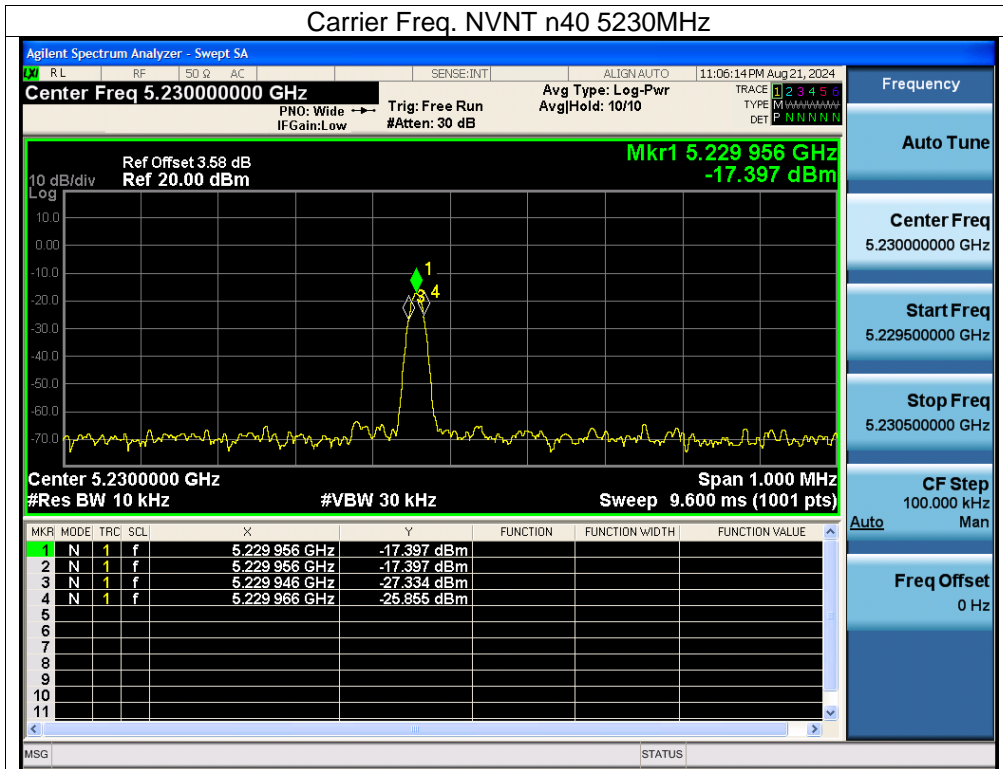

CO. LTD

8. Nominal Channel Bandwidth And Occupied Channel Bandwidth

8.1 Block Diagram Of Test Setup

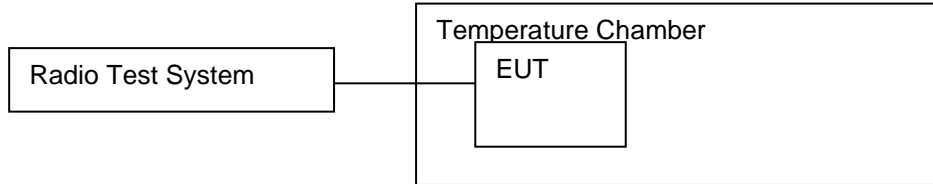

8.2 Limit

The Nominal Channel Bandwidth for a single Operating Channel shall be 20 MHz. Alternatively, equipment may implement a lower Nominal Channel Bandwidth with a minimum of 5 MHz, providing they still comply with the Nominal Centre Frequencies defined in clause 4.2.1 (20 MHz raster). The Occupied Channel Bandwidth shall be between 80 % and 100 % of the Nominal Channel Bandwidth. In case of smart antenna systems (devices with multiple transmit chains) each of the transmit chains shall meet this requirement. The Occupied Channel Bandwidth might change with time/payload.

8.3 Test Procedure

Step 1:

- Connect the UUT to the spectrum analyzer and use the following settings:
- Centre Frequency: The centre frequency of the channel under test
- Resolution Bandwidth: 100 kHz
- Video Bandwidth: 300 kHz
- Frequency Span: $2 \times$ Nominal Bandwidth (e.g. 40 MHz for a 20 MHz channel)
- Sweep time: > 1 s; for larger Nominal Bandwidths, the sweep time may be increased until a value where the sweep time has no impact on the RMS value of the signal
- Detector Mode: RMS
- Trace Mode: Max Hold

Step 2:

- Wait for the trace to stabilize.

Step 3:

- Make sure that the power envelope is sufficiently above the noise floor of the analyzer to avoid the noise signals left and right from the power envelope being taken into account by this measurement.
- Use the 99 % bandwidth function of the spectrum analyzer to measure the Occupied Channel Bandwidth of the UUT. This value shall be recorded.

The measurement described in step 1 to step 3 above shall be repeated in case of simultaneous transmissions in non-adjacent channels.

8.4 Test Result

Condition	Mode	Frequency (MHz)	Center Frequency (MHz)	OBW (MHz)	Verdict
NVNT	a	5180	5179.963	16.44	Pass
NVNT	a	5200	5199.964	16.435	Pass
NVNT	a	5240	5239.96	16.436	Pass
NVNT	n20	5180	5179.963	17.656	Pass
NVNT	n20	5200	5199.967	17.661	Pass
NVNT	n20	5240	5239.962	17.663	Pass
NVNT	n40	5190	5189.972	36.206	Pass
NVNT	n40	5230	5229.959	36.197	Pass
NVNT	ac20	5180	5179.968	17.652	Pass
NVNT	ac20	5200	5199.967	17.662	Pass
NVNT	ac20	5240	5239.964	17.657	Pass
NVNT	ac40	5190	5189.973	36.207	Pass
NVNT	ac40	5230	5229.957	36.206	Pass
NVNT	ac80	5210	5209.987	75.557	Pass
NVNT	ax20	5180	5179.971	18.935	Pass
NVNT	ax20	5200	5199.967	18.938	Pass
NVNT	ax20	5240	5239.961	18.932	Pass
NVNT	ax40	5190	5189.978	37.659	Pass
NVNT	ax40	5230	5229.923	37.603	Pass
NVNT	ax80	5210	5209.995	77.161	Pass



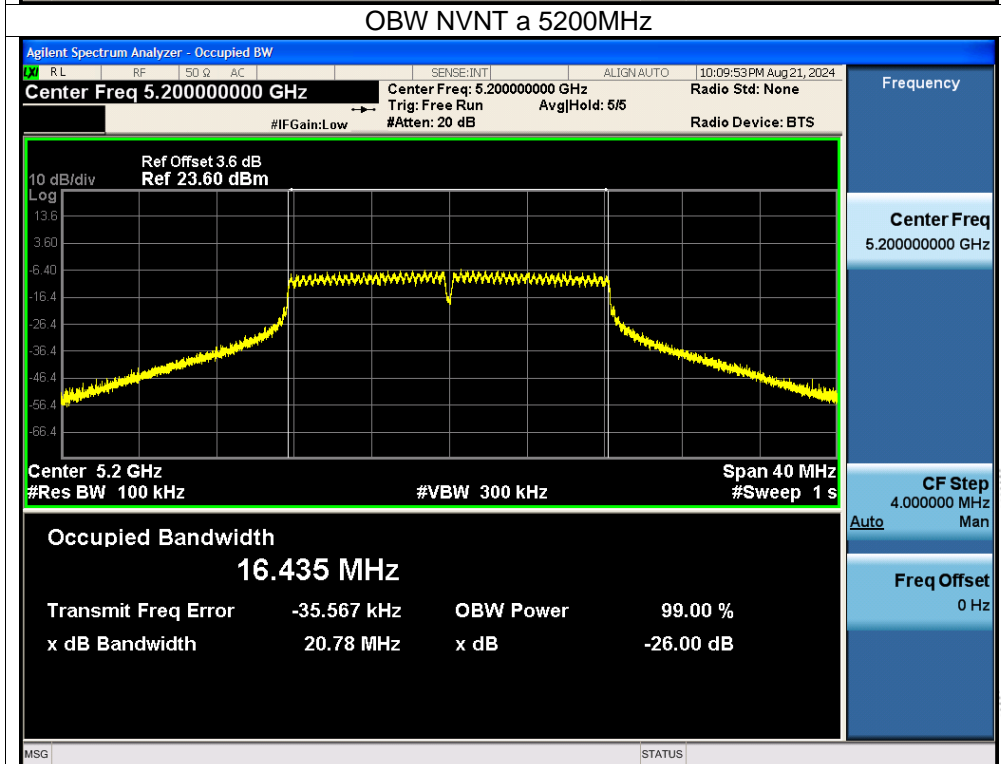
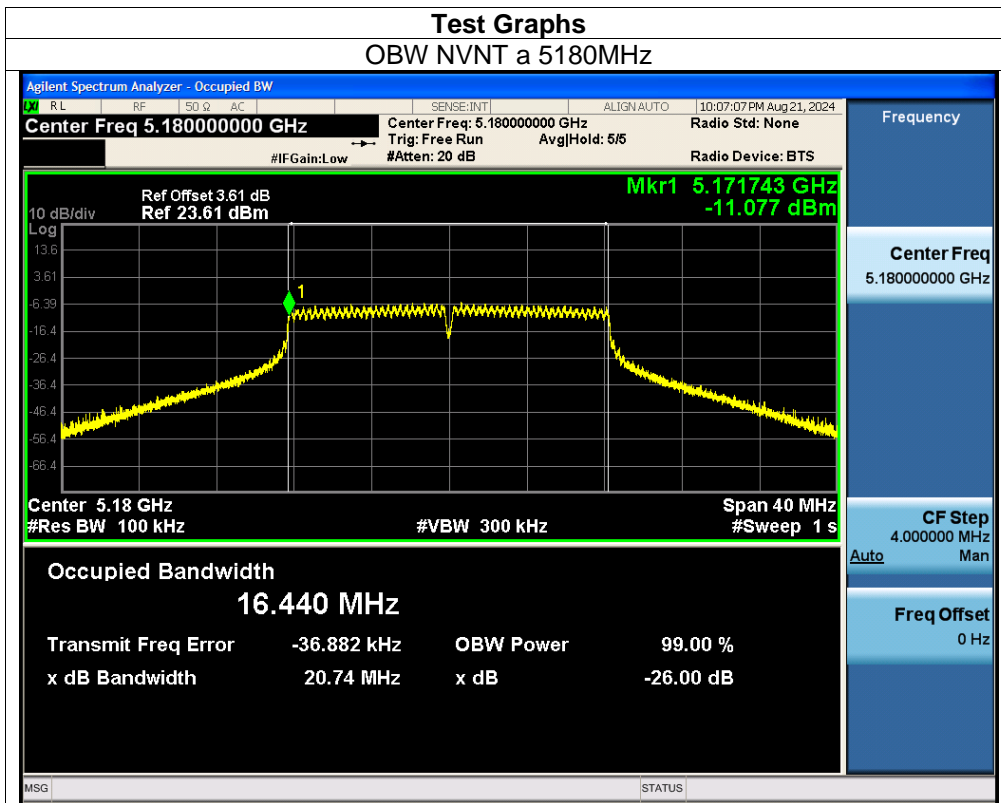

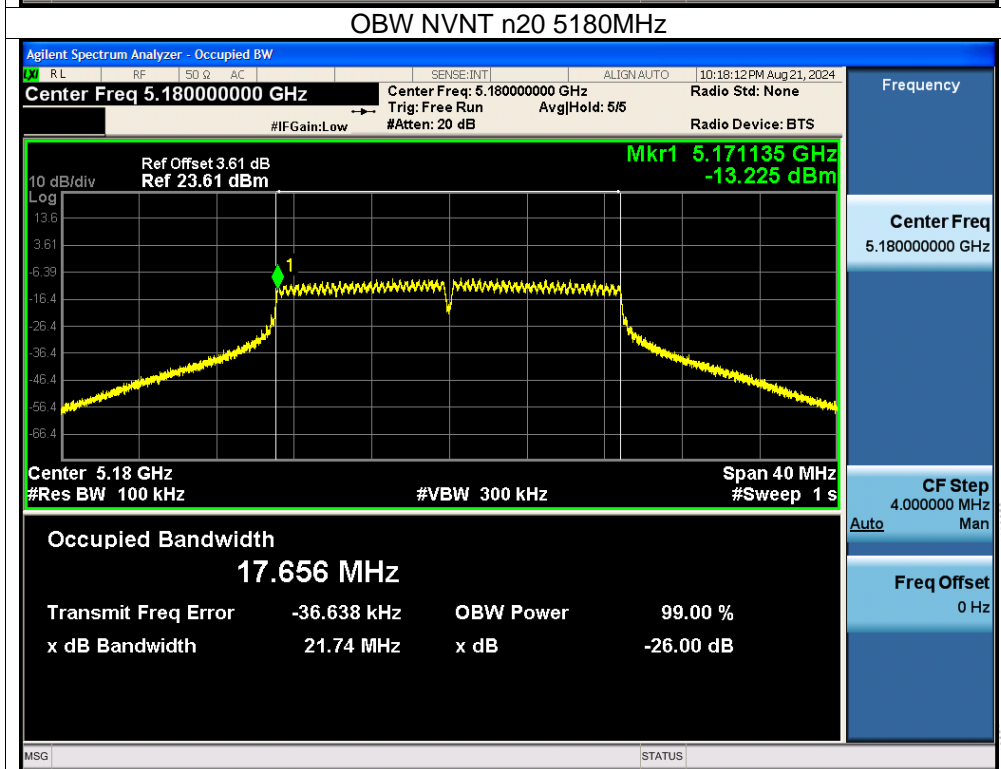
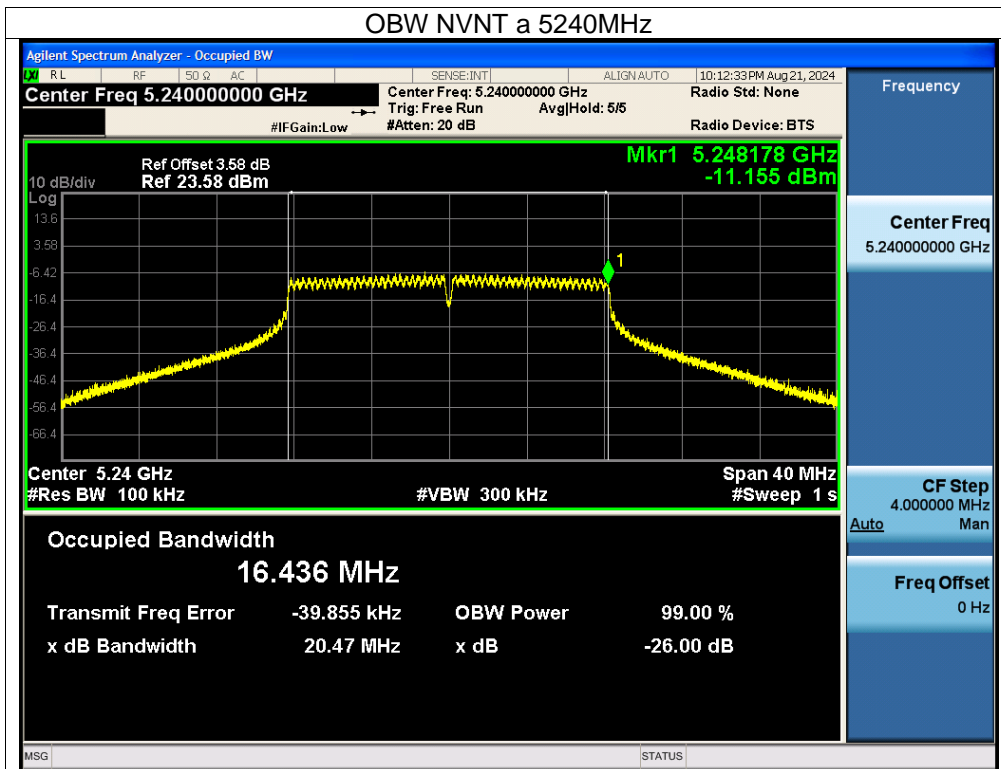

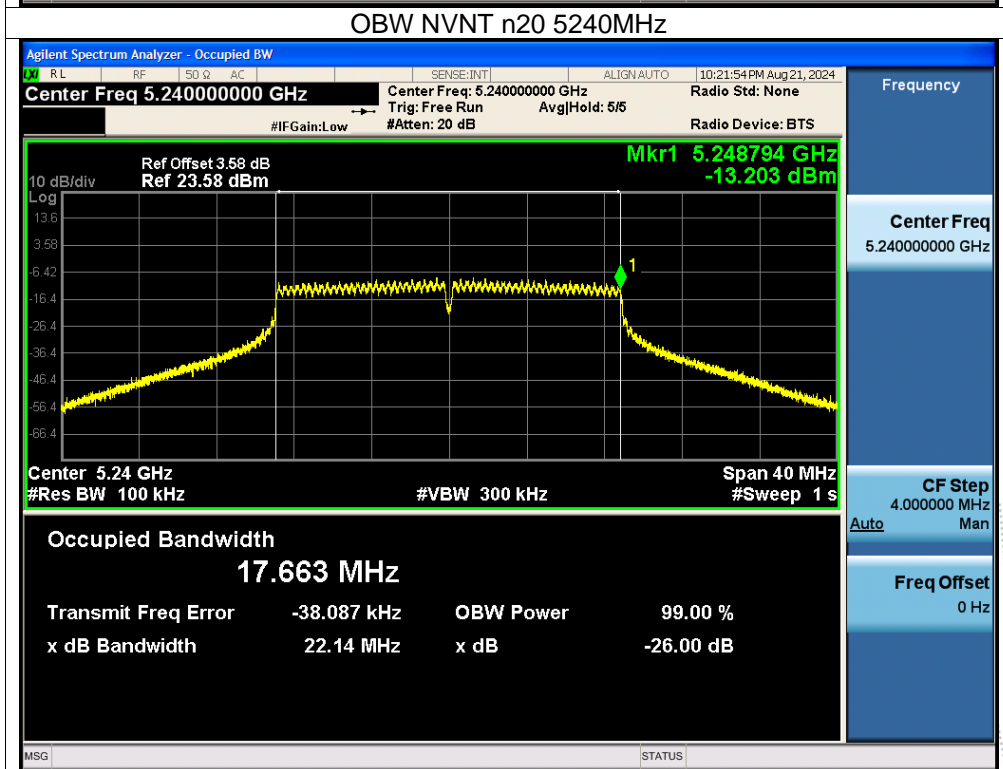
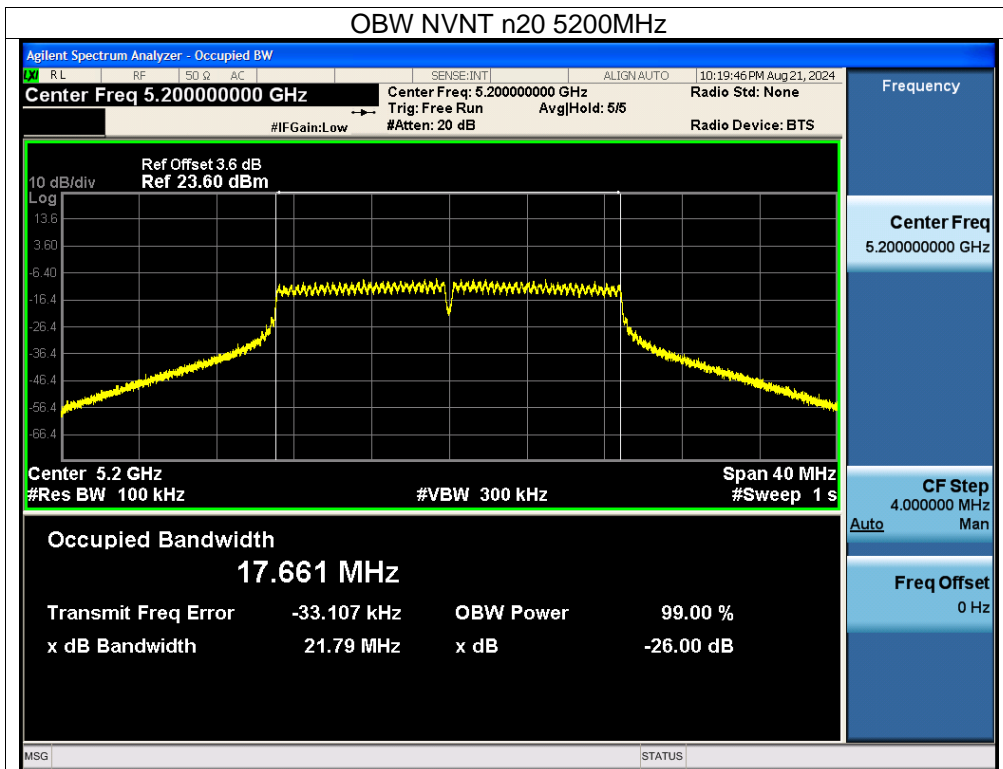

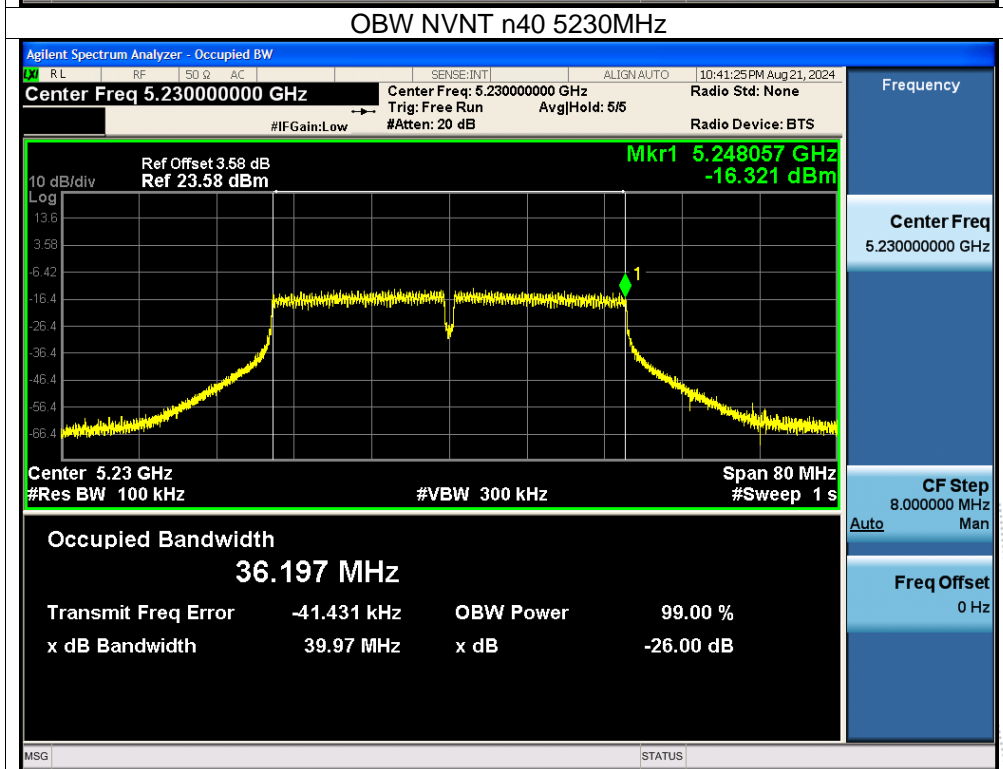
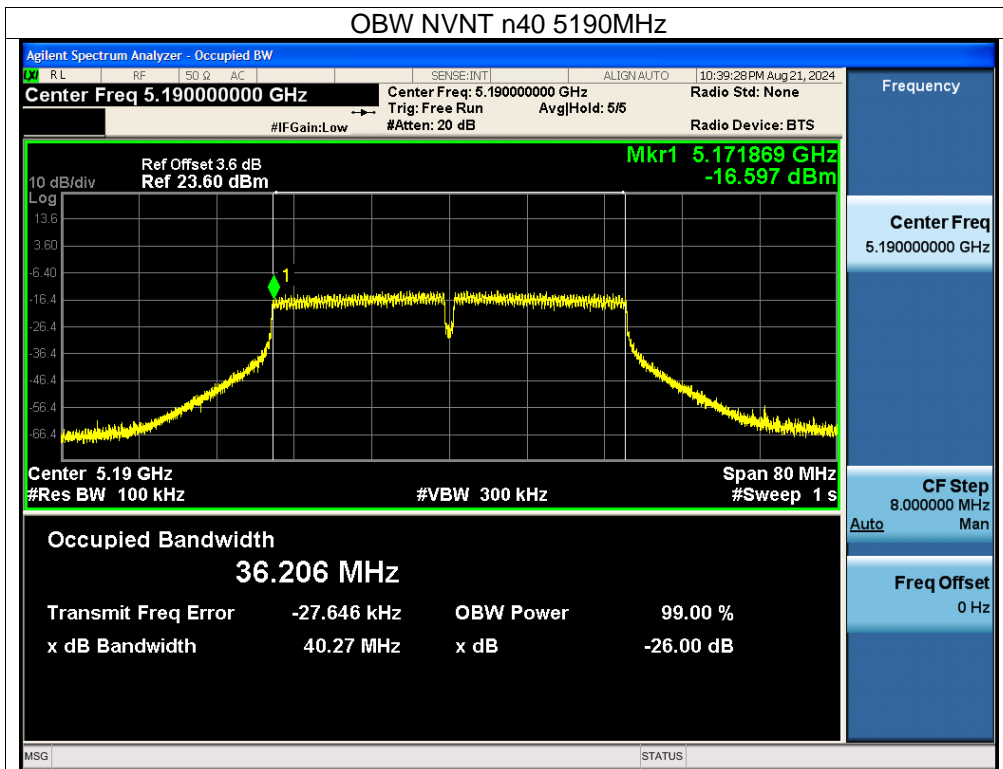

CO.LTD

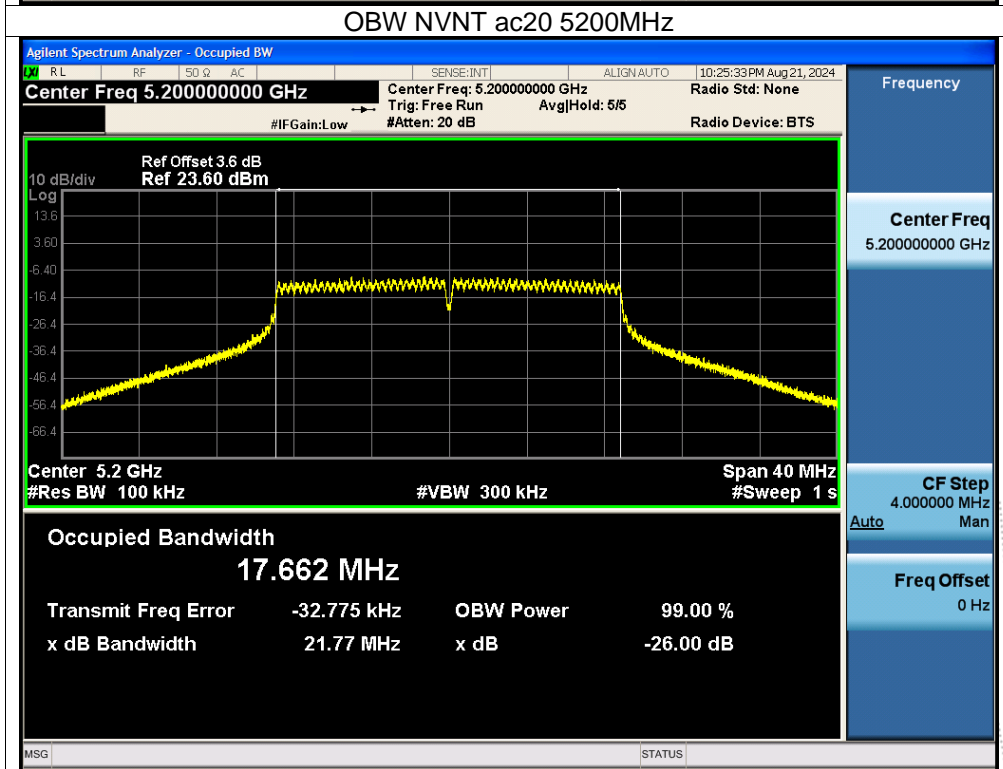
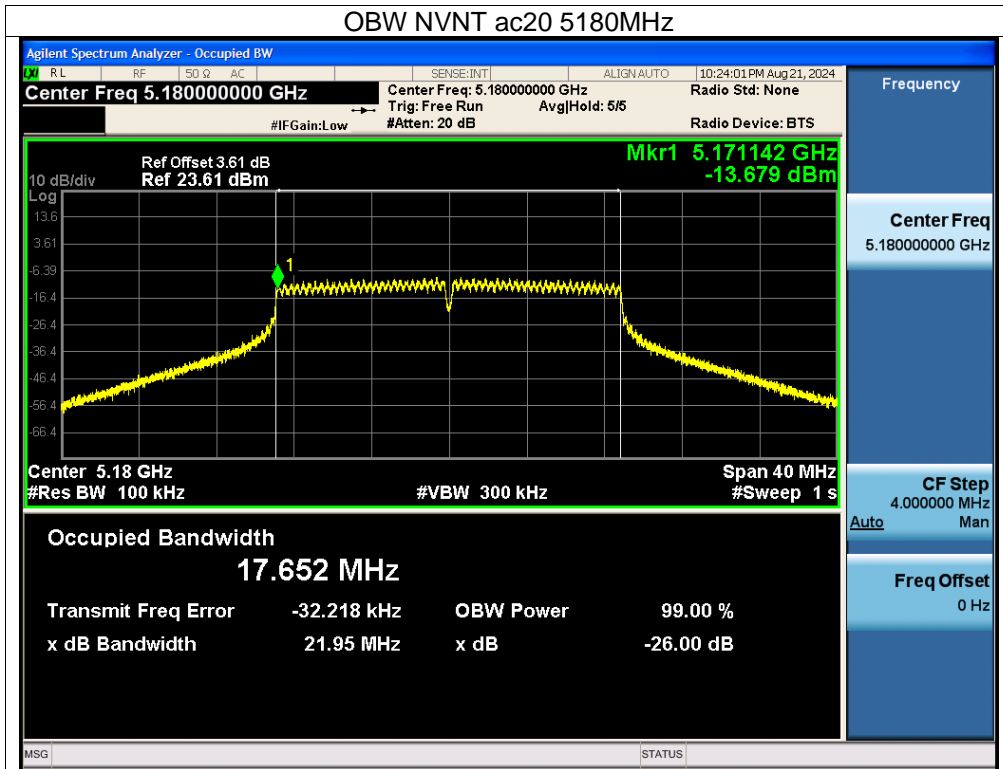

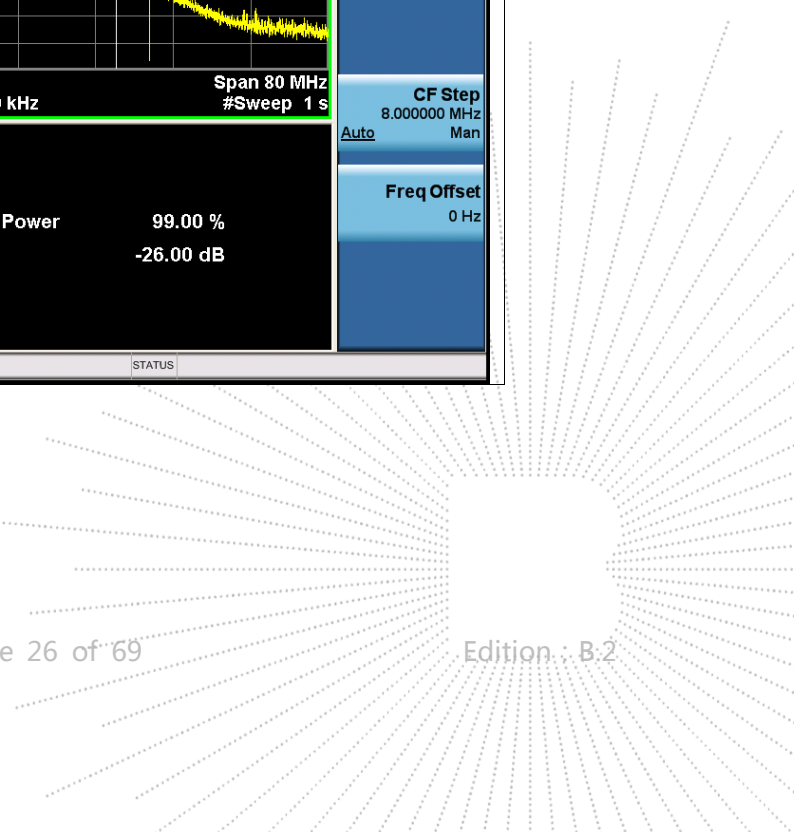
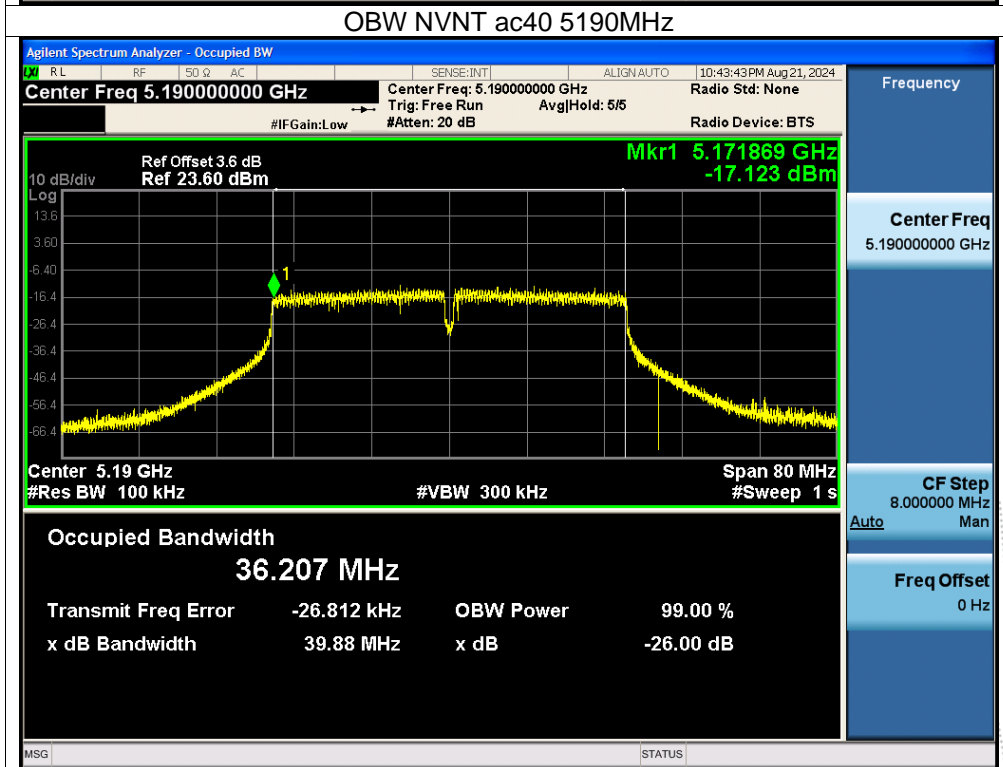
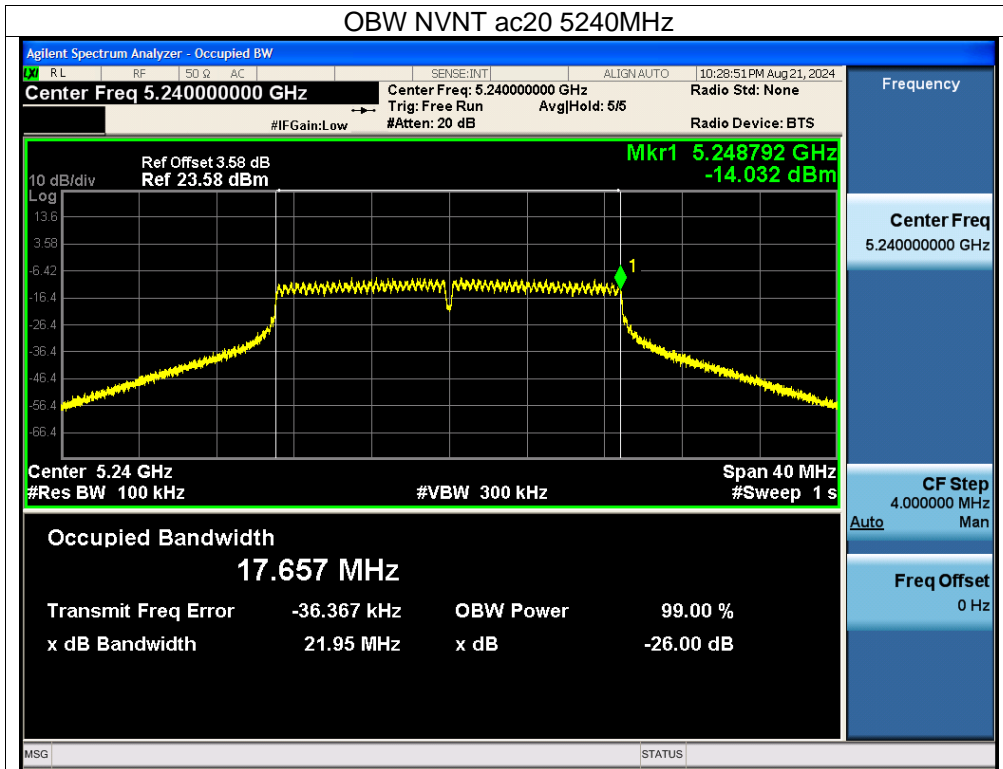

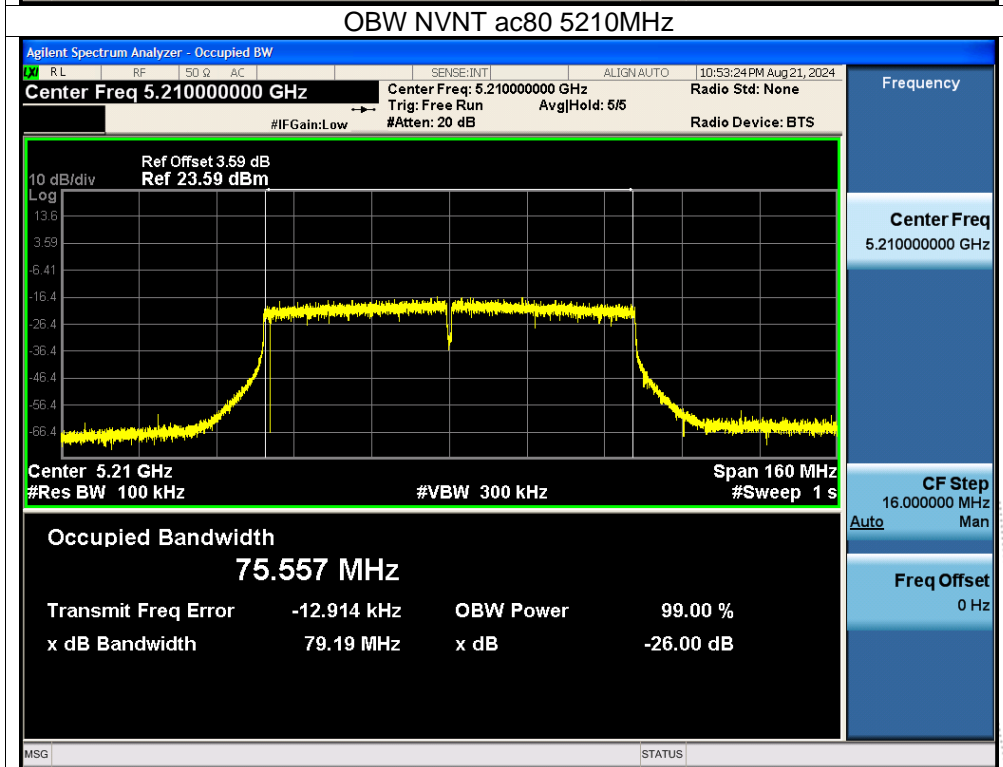
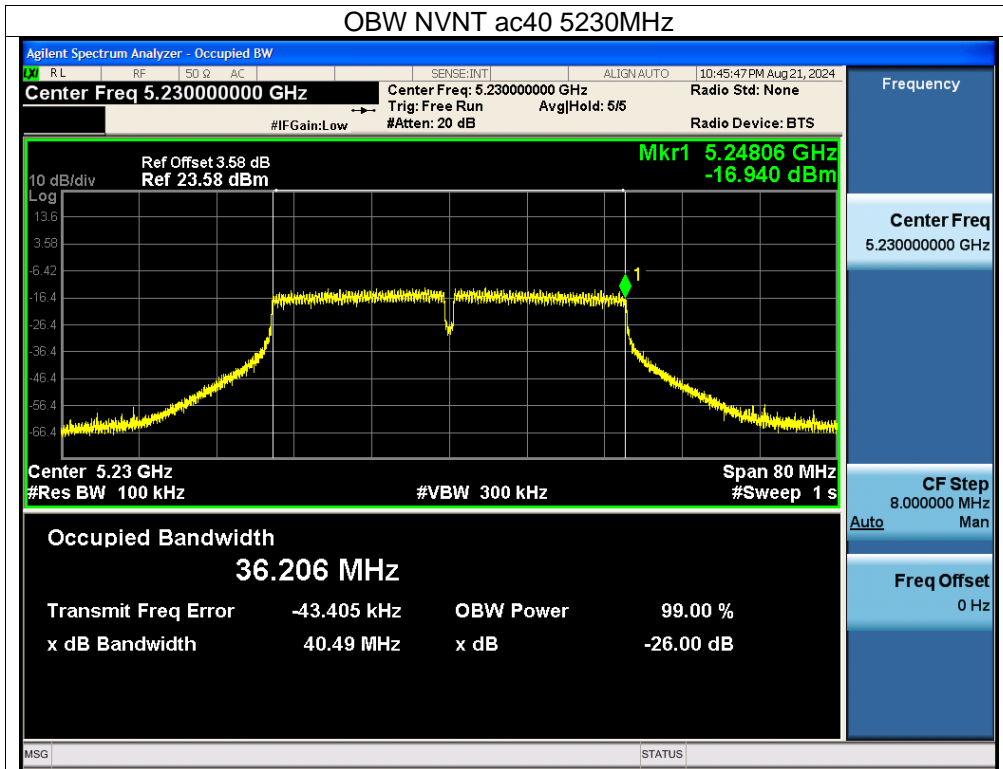

BCTC
3C
PPR
Report

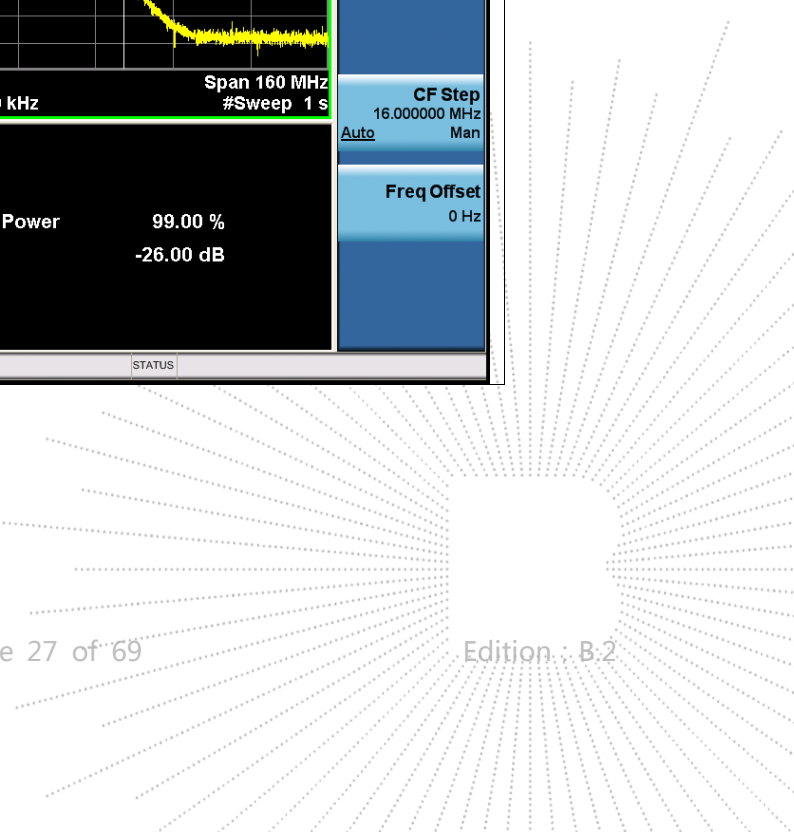

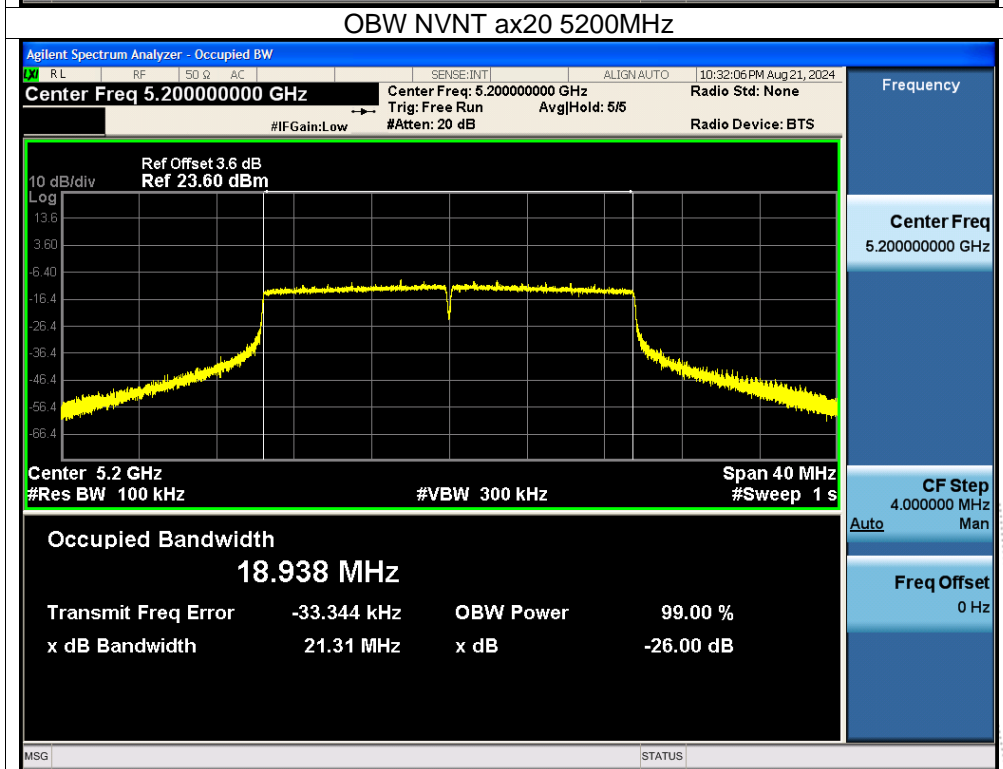
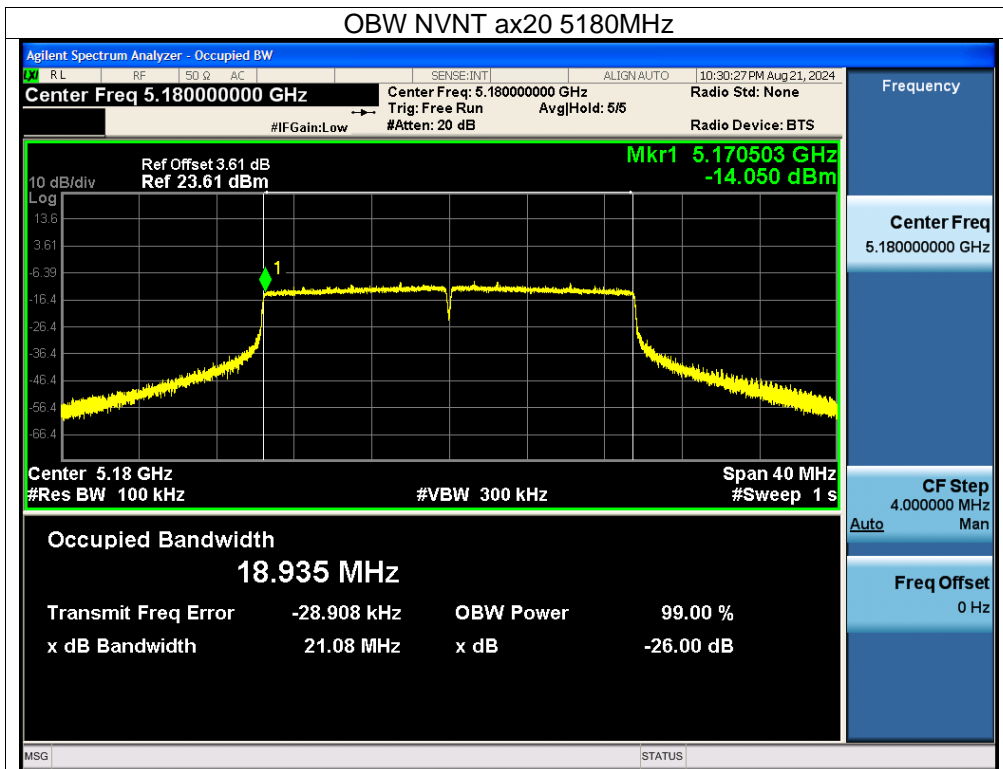

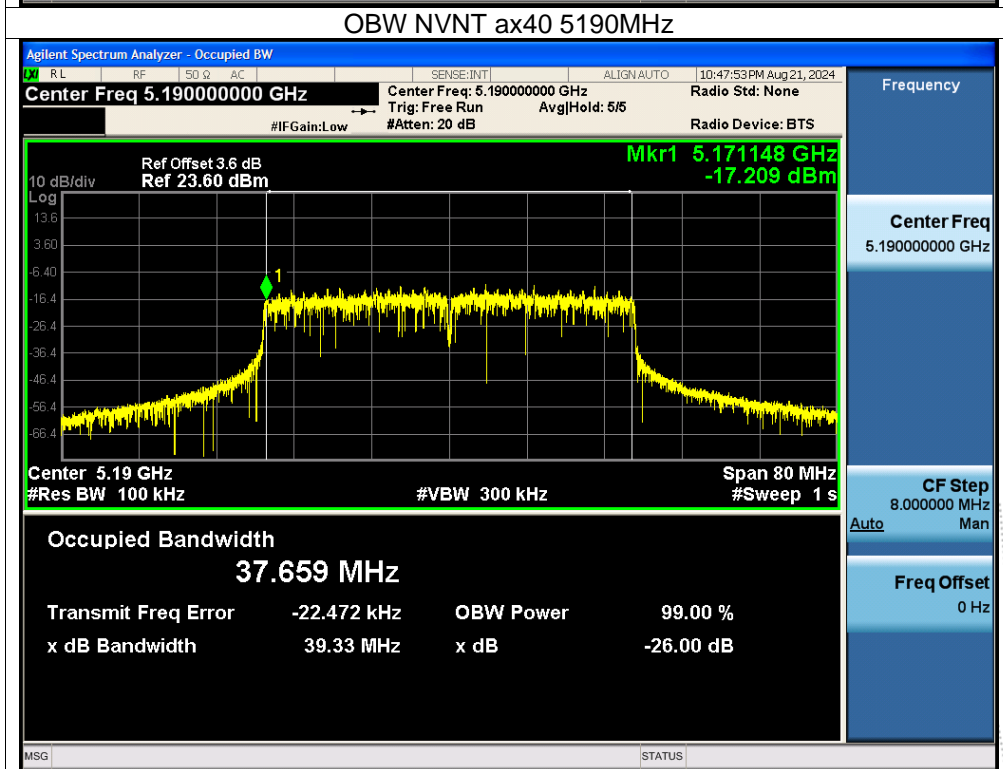
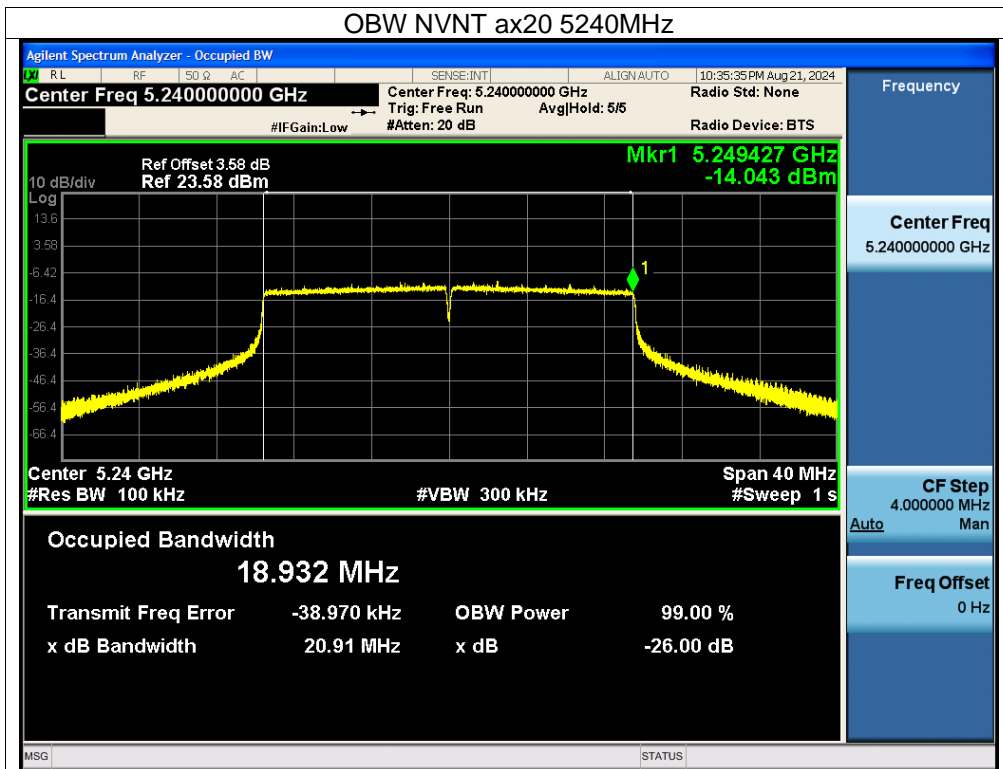

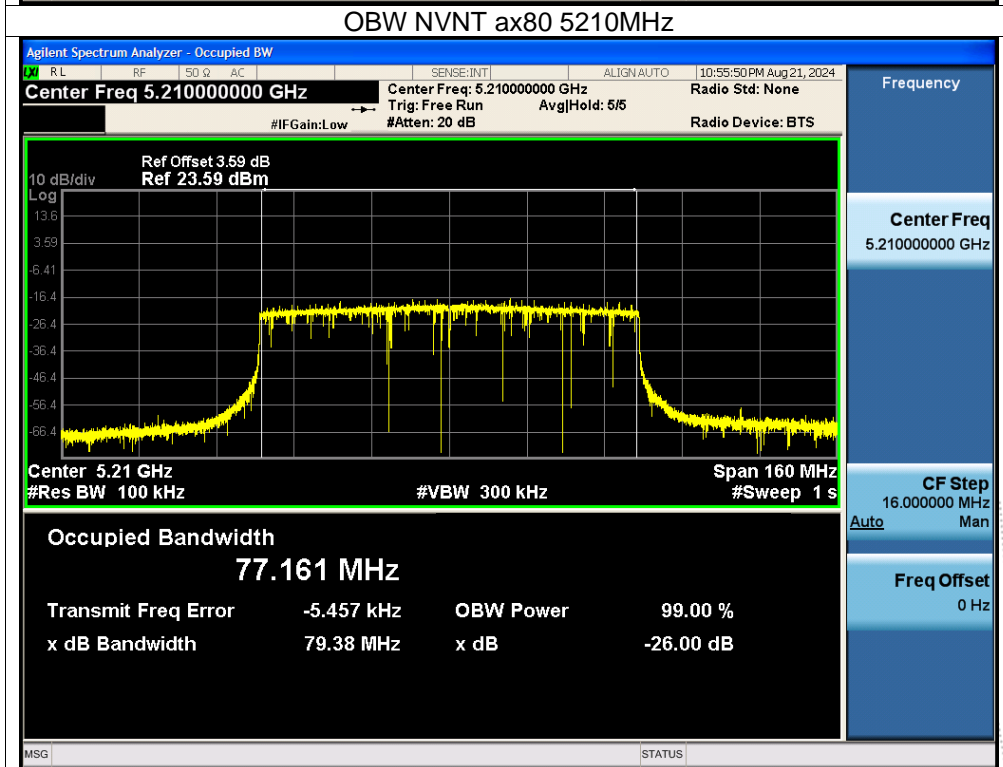
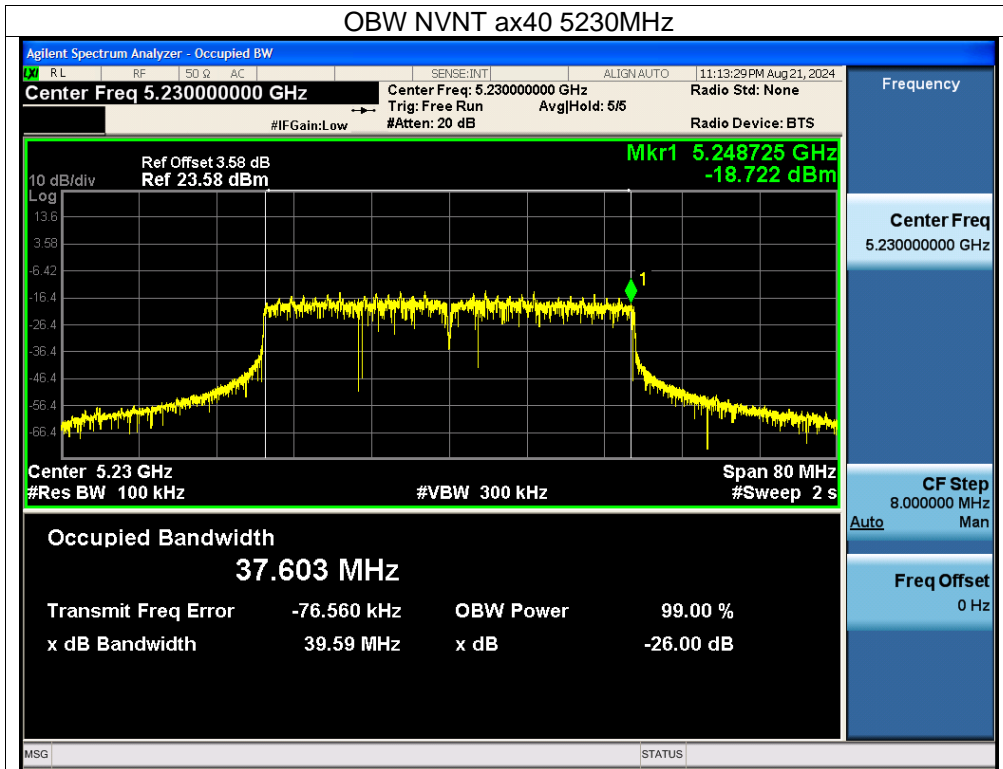

CO., LTD

9. RF Output Power, Transmit Power Control (TPC)

9.1 Block Diagram Of Test Setup

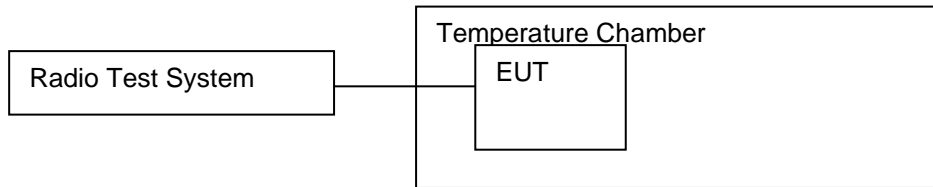

9.2 Limit

Frequency range (MHz)	Mean e.i.r.p. limit for P_H (dBm)		Mean e.i.r.p. density limit (dBm/MHz)	
	with TPC	without TPC	with TPC	without TPC
5 150 to 5 350	23	20/23 (see note 1)	10	7/10 (see note 2)
5 470 to 5 725	30 (see note 3)	27 (see note 3)	17 (see note 3)	14 (see note 3)

NOTE 1: The applicable limit is 20 dBm, except for transmissions whose nominal bandwidth falls completely within the band 5 150 MHz to 5 250 MHz, in which case the applicable limit is 23 dBm.

NOTE 2: The applicable limit is 7 dBm/MHz, except for transmissions whose nominal bandwidth falls completely within the band 5 150 MHz to 5 250 MHz, in which case the applicable limit is 10 dBm/MHz.

NOTE 3: Slave devices without a *Radar Interference Detection* function shall comply with the limits for the frequency range 5 250 MHz to 5 350 MHz.

9.3 Test Procedure

This option is for equipment that operates only in one sub-band or that is capable for operation in two sub-bands simultaneously but, for the purpose of the testing, the equipment can be configured to:

- operate in a continuous transmit mode or with a constant duty cycle (x), and
- operate only in one sub-band.

Step 1:

For equipment configured into a continuous transmit mode ($x = 1$), proceed immediately with step 2.

- The output power of the transmitter shall be coupled to a matched diode detector or equivalent thereof. The output of the diode detector shall be connected to the vertical channel of an oscilloscope.
- The combination of the diode detector and the oscilloscope shall be capable of faithfully reproducing the duty cycle of the transmitter output signal.
- The observed duty cycle of the transmitter (Tx on / (Tx on + Tx off)) shall be noted as x ($0 < x \leq 1$), and recorded in the test report.

Step 2:

- The RF output power shall be determined using a wideband RF power meter with a thermocouple detector or an equivalent thereof and with an integration period that exceeds the repetition period of the transmitter by a factor 5 or more. The observed value shall be noted as A (in dBm).
- In case of conducted measurements on smart antenna systems operating in a mode with multiple transmit chains active simultaneously, the output power of each transmit chain shall be measured separately to calculate the total power (value A in dBm) for the UUT.

Step 3:

• The RF output power at the highest power level PH (e.i.r.p.) shall be calculated from the above measured power output A (in dBm), the observed duty cycle x, the stated antenna gain G in dBi and if applicable the beamforming gain Y in dB, according to the formula below. This value shall be recorded in the test report. If more than one antenna assembly is intended for this power setting or TPC range, the gain of the antenna assembly with the highest gain shall be used.

$$PH = A + G + Y + 10 \times \log (1 / x) \text{ (dBm)}. \text{ (5)}$$

• This value PH shall be compared to the applicable limit contained in table 2 of clause 4.2.3.2.2.

9.4 Test Result

Remark: $PH = A + G + Y + 10 \times \log (1 / x) \text{ (dBm)}$

Antenna Gain $G=1.42 \text{ dBi}$, beamforming gain $Y= 0 \text{ dB}$, duty cycle $X=100\%$



Condition	Mode	Frequency (MHz)	Max Burst RMS Power (dBm)	Burst Number	Gain (dBi)	Max EIRP (dBm)	Limit (dBm)	Verdict
NVNT	a	5180	9.88	41	1.42	11.3	23	Pass
NVNT	a	5200	9.37	46	1.42	10.79	23	Pass
NVNT	a	5240	9.61	46	1.42	11.03	23	Pass
NVNT	n20	5180	8.11	49	1.42	9.53	23	Pass
NVNT	n20	5200	7.40	49	1.42	8.82	23	Pass
NVNT	n20	5240	7.63	51	1.42	9.05	23	Pass
NVNT	n40	5190	6.62	91	1.42	8.04	23	Pass
NVNT	n40	5230	6.60	74	1.42	8.02	23	Pass
NVNT	ac20	5180	7.59	43	1.42	9.01	23	Pass
NVNT	ac20	5200	7.45	50	1.42	8.87	23	Pass
NVNT	ac20	5240	7.60	50	1.42	9.02	23	Pass
NVNT	ac40	5190	6.54	92	1.42	7.96	23	Pass
NVNT	ac40	5230	6.64	74	1.42	8.06	23	Pass
NVNT	ac80	5210	5.55	159	1.42	6.97	23	Pass
NVNT	ax20	5180	7.50	62	1.42	8.92	23	Pass
NVNT	ax20	5200	7.41	61	1.42	8.83	23	Pass
NVNT	ax20	5240	7.57	62	1.42	8.99	23	Pass
NVNT	ax40	5190	7.79	191	1.42	9.21	23	Pass
NVNT	ax40	5230	7.49	189	1.42	8.91	23	Pass
NVNT	ax80	5210	5.48	177	1.42	6.9	23	Pass
NVLT	a	5180	9.20	41	1.42	10.62	23	Pass
NVLT	a	5200	9.03	46	1.42	10.45	23	Pass
NVLT	a	5240	8.72	46	1.42	10.14	23	Pass
NVLT	n20	5180	7.24	49	1.42	8.66	23	Pass
NVLT	n20	5200	7.10	49	1.42	8.52	23	Pass
NVLT	n20	5240	7.44	51	1.42	8.86	23	Pass
NVLT	n40	5190	6.33	91	1.42	7.75	23	Pass
NVLT	n40	5230	5.73	74	1.42	7.15	23	Pass
NVLT	ac20	5180	7.27	43	1.42	8.69	23	Pass
NVLT	ac20	5200	7.28	50	1.42	8.70	23	Pass
NVLT	ac20	5240	6.78	50	1.42	8.20	23	Pass
NVLT	ac40	5190	5.60	92	1.42	7.02	23	Pass
NVLT	ac40	5230	5.78	74	1.42	7.20	23	Pass
NVLT	ac80	5210	5.05	159	1.42	6.47	23	Pass
NVLT	ax20	5180	7.36	62	1.42	8.78	23	Pass
NVLT	ax20	5200	7.02	61	1.42	8.44	23	Pass
NVLT	ax20	5240	6.79	62	1.42	8.21	23	Pass
NVLT	ax40	5190	7.31	191	1.42	8.73	23	Pass
NVLT	ax40	5230	6.50	189	1.42	7.92	23	Pass
NVLT	ax80	5210	4.87	177	1.42	6.29	23	Pass
NVHT	a	5180	8.44	41	1.42	9.86	23	Pass
NVHT	a	5200	9.00	46	1.42	10.42	23	Pass

NVHT	a	5240	8.45	46	1.42	9.87	23	Pass
NVHT	n20	5180	7.06	49	1.42	8.48	23	Pass
NVHT	n20	5200	6.18	49	1.42	7.60	23	Pass
NVHT	n20	5240	6.69	51	1.42	8.11	23	Pass
NVHT	n40	5190	5.37	91	1.42	6.79	23	Pass
NVHT	n40	5230	5.02	74	1.42	6.44	23	Pass
NVHT	ac20	5180	7.26	43	1.42	8.68	23	Pass
NVHT	ac20	5200	6.41	50	1.42	7.83	23	Pass
NVHT	ac20	5240	6.35	50	1.42	7.77	23	Pass
NVHT	ac40	5190	5.52	92	1.42	6.94	23	Pass
NVHT	ac40	5230	5.02	74	1.42	6.44	23	Pass
NVHT	ac80	5210	4.66	159	1.42	6.08	23	Pass
NVHT	ax20	5180	6.99	62	1.42	8.41	23	Pass
NVHT	ax20	5200	6.83	61	1.42	8.25	23	Pass
NVHT	ax20	5240	6.75	62	1.42	8.17	23	Pass
NVHT	ax40	5190	6.67	191	1.42	8.09	23	Pass
NVHT	ax40	5230	6.42	189	1.42	7.84	23	Pass
NVHT	ax80	5210	4.08	177	1.42	5.50	23	Pass

TEC
TC
OVER
t See



10. Power Spectral Density

10.1 Block Diagram Of Test Setup

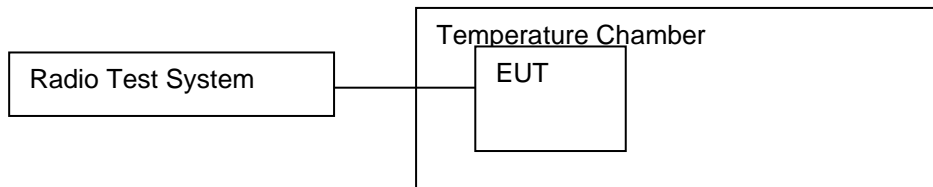

10.2 Limit

Frequency range (MHz)	Mean e.i.r.p. limit for P_H (dBm)		Mean e.i.r.p. density limit (dBm/MHz)	
	with TPC	without TPC	with TPC	without TPC
5 150 to 5 350	23	20/23 (see note 1)	10	7/10 (see note 2)
5 470 to 5 725	30 (see note 3)	27 (see note 3)	17 (see note 3)	14 (see note 3)

NOTE 1: The applicable limit is 20 dBm, except for transmissions whose nominal bandwidth falls completely within the band 5 150 MHz to 5 250 MHz, in which case the applicable limit is 23 dBm.

NOTE 2: The applicable limit is 7 dBm/MHz, except for transmissions whose nominal bandwidth falls completely within the band 5 150 MHz to 5 250 MHz, in which case the applicable limit is 10 dBm/MHz.

NOTE 3: Slave devices without a *Radar Interference Detection* function shall comply with the limits for the frequency range 5 250 MHz to 5 350 MHz.

10.3 Test Procedure

This option is for equipment that can be configured to operate in a continuous transmit mode or with a constant duty cycle (x).

Step 1:

- Connect the UUT to the spectrum analyzer and use the following settings:
 - Centre Frequency: The centre frequency of the channel under test
 - RBW: 1 MHz
 - VBW: 3 MHz
 - Frequency Span: 2 × Nominal Bandwidth (e.g. 40 MHz for a 20 MHz channel)
 - Detector Mode: Peak
 - Trace Mode: Max Hold

Step 2:

- When the trace is complete, find the peak value of the power envelope and record the frequency.

Step 3:

- Make the following changes to the settings of the spectrum analyzer:
 - Centre Frequency: Equal to the frequency recorded in step 2
 - Frequency Span: 3 MHz
 - RBW: 1 MHz
 - VBW: 3 MHz
 - Sweep Time: 1 minute
 - Detector Mode: RMS
 - Trace Mode: Max Hold

Step 4:

- When the trace is complete, the trace shall be captured using the "Hold" or "View" option on the spectrum analyzer.
- Find the peak value of the trace and place the analyzer marker on this peak. This level is recorded as the highest mean power (Power Density) D in a 1 MHz band.
- Alternatively, where a spectrum analyzer is equipped with a function to measure spectral Power Density, this function may be used to display the Power Density D in dBm / MHz.
- In case of conducted measurements on smart antenna systems operating in a mode with multiple transmit chains active simultaneously, the Power Density of each transmit chain shall be measured separately to calculate the total Power Density (value D in dBm / MHz) for the UUT.

Step 5:

- The maximum spectral Power Density e.i.r.p. is calculated from the above measured Power Density D, the observed duty cycle x (see clause 5.4.4.2.1.1.2, step 1), the applicable antenna assembly gain G in dBi and if applicable the beamforming gain Y in dB, according to the formula below. This value shall be recorded in the test report. If more than one antenna assembly is intended for this power setting, the gain of the antenna assembly with the highest gain shall be used:

$$PD = D + G + Y + 10 \times \log (1 / x) \text{ (dBm / MHz) (14)}$$

10.4 Test Result

Remark: $PH = A + G + Y + 10 \times \log (1 / x) \text{ (dBm)}$

G= Antenna Gain=1.42 dBi, beamforming gain Y= 0 dB, duty cycle X=100%

Condition	Mode	Frequency (MHz)	Max PSD (dBm/MHz)	Limit (dBm/MHz)	Verdict
NVNT	a	5180	0.02	10	Pass
NVNT	a	5200	-0.53	10	Pass
NVNT	a	5240	-0.31	10	Pass
NVNT	n20	5180	-2.11	10	Pass
NVNT	n20	5200	-2.66	10	Pass
NVNT	n20	5240	-2.49	10	Pass
NVNT	n40	5190	-6.38	10	Pass
NVNT	n40	5230	-6.51	10	Pass
NVNT	ac20	5180	-2.51	10	Pass
NVNT	ac20	5200	-2.71	10	Pass
NVNT	ac20	5240	-2.7	10	Pass
NVNT	ac40	5190	-6.45	10	Pass
NVNT	ac40	5230	-6.47	10	Pass
NVNT	ac80	5210	-10.36	10	Pass
NVNT	ax20	5180	-2.98	10	Pass
NVNT	ax20	5200	-3.08	10	Pass
NVNT	ax20	5240	-3.09	10	Pass
NVNT	ax40	5190	-5.28	10	Pass
NVNT	ax40	5230	-4.28	10	Pass
NVNT	ax80	5210	-10.73	10	Pass

11. Transmitter Unwanted Emissions In The Spurious Domain

11.1 Block Diagram Of Test Setup

(A) Radiated Emission Test Set-Up Frequency Below 1GHz.

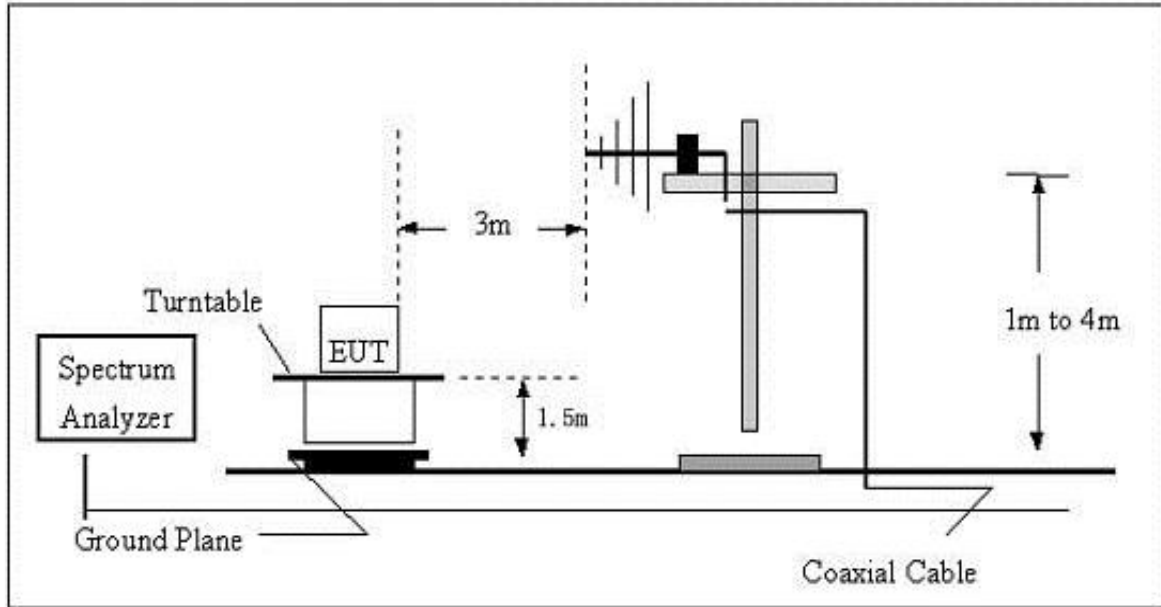

(B) Radiated Emission Test Set-Up Frequency Above 1GHz.

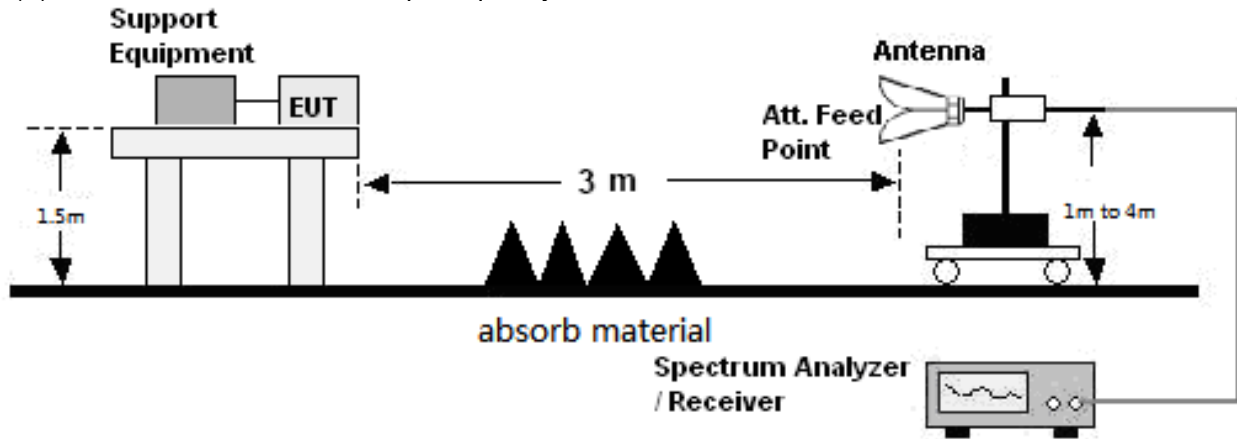

11.2 Limits

Frequency range	Maximum power, e.r.p. (≤ 1 GHz) e.i.r.p. (> 1 GHz)	Bandwidth
30 MHz to 47 MHz	-36 dBm	100 kHz/300KHz
47 MHz to 74 MHz	-54 dBm	100 kHz/300KHz
74 MHz to 87,5 MHz	-36 dBm	100 kHz/300KHz
87,5 MHz to 118 MHz	-54 dBm	100 kHz/300KHz
118 MHz to 174 MHz	-36 dBm	100 kHz/300KHz
174 MHz to 230 MHz	-54 dBm	100 kHz/300KHz
230 MHz to 470 MHz	-36 dBm	100 kHz/300KHz
470 MHz to 862 MHz	-54 dBm	100 kHz/300KHz
862 MHz to 1 GHz	-36 dBm	100 kHz/300KHz
1 GHz to 5.15 GHz	-30 dBm	1 MHz/3MHz
5.35 GHz to 5.47 GHz	-30 dBm	1 MHz/3MHz
5.725 GHz to 26 GHz	-30 dBm	1 MHz/3MHz

11.3 Test Procedure

30MHz ~ 1GHz:

- The Product was placed on the nonconductive turntable 1.5m above the ground in a full anechoic chamber.
- Set the spectrum analyzer/receiver in Peak detector, Max Hold mode, and 120 kHz RBW. Record the maximum field strength of all the pre-scan process in the full band when the antenna is varied between 1–4 m in both horizontal and vertical, and the turntable is rotated from 0 to 360 degrees.
- For each frequency whose maximum record was higher or close to limit, measure its QP value: vary the antenna's height and rotate the turntable from 0 to 360 degrees to find the height and degree where Product radiated the maximum emission, then set the test frequency analyzer/receiver to QP Detector and specified bandwidth with Maximum Hold Mode, and record the maximum value.

Above 1GHz:

- The Product was placed on the non-conductive turntable 1.5 m above the ground in a full anechoic chamber.
- Set the spectrum analyzer/receiver in Peak detector, Max Hold mode, and 1MHz RBW. Record the maximum field strength of all the pre-scan process in the full band when the antenna is varied in both horizontal and vertical, and the turntable is rotated from 0 to 360 degrees.
- For each frequency whose maximum record was higher or close to limit, measure its AV value: rotate the turntable from 0 to 360 degrees to find the degree where Product radiated the maximum emission, then set the test frequency analyzer/receiver to AV value and specified bandwidth with Maximum Hold Mode, and record the maximum value.

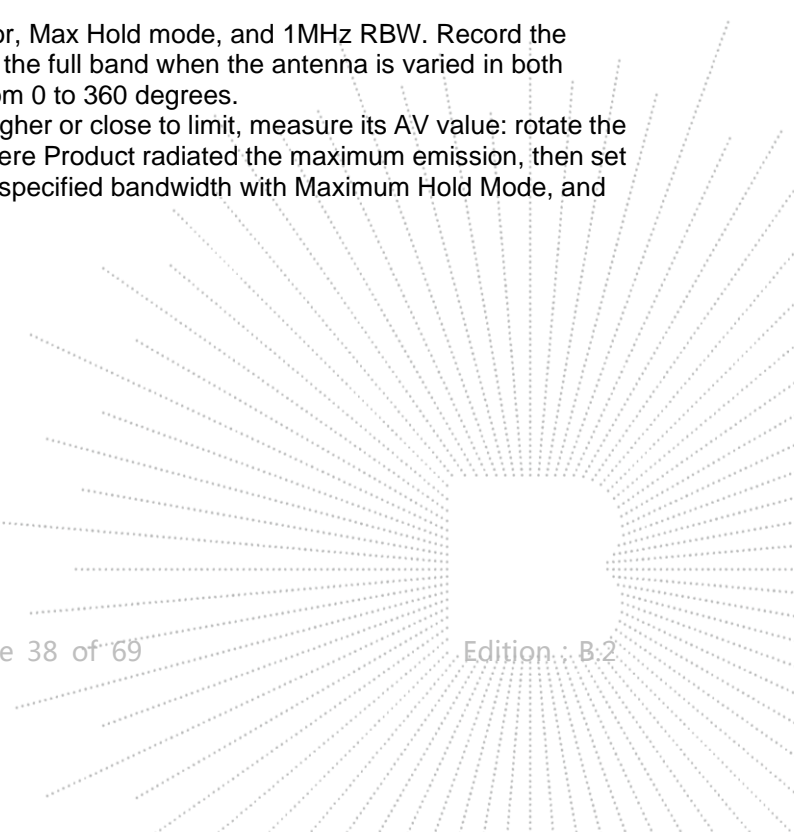

11.4 Test Results

All modes have been tested and reports show data in the worst mode
 Test Mode: Transmitting 802.11n20 (worst case)

Frequency (MHz)	Receiver Reading (dBm)	Turn table Angle Degree	RX Antenna		Correct Factor (dB)	Absolute Level (dBm)	Result	
			Height (m)	Polar (H/V)			Limit (dBm)	Margin (dB)
802.11n20 low channel								
590.52	-35.40	43	1.4	H	-27.81	-63.21	-54	-9.21
590.52	-32.66	340	1.5	V	-27.81	-60.47	-54	-6.47
10360.00	-34.41	82	1.6	H	-9.36	-43.77	-30	-13.77
10360.00	-35.34	272	1.0	V	-9.36	-44.70	-30	-14.70
15540.00	-39.65	274	1.6	H	-7.84	-47.49	-30	-17.49
15540.00	-46.62	160	1.9	V	-7.84	-54.46	-30	-24.46
802.11n20 Mid channel								
590.52	-36.19	204	1.9	H	-27.81	-64.01	-54	-10.01
590.52	-32.26	136	1.0	V	-27.81	-60.07	-54	-6.07
10400.00	-34.73	190	1.0	H	-9.30	-44.03	-30	-14.03
10400.00	-34.53	128	1.9	V	-9.30	-43.83	-30	-13.83
15600.00	-40.17	38	1.0	H	-7.82	-47.99	-30	-17.99
15600.00	-47.58	224	1.2	V	-7.82	-55.40	-30	-25.40
802.11n20 high channel								
590.52	-35.08	196	1.4	H	-27.81	-62.89	-54	-8.89
590.52	-32.65	63	1.6	V	-27.81	-60.46	-54	-6.46
10480.00	-33.64	350	1.1	H	-9.18	-42.82	-30	-12.82
10480.00	-35.57	295	1.0	V	-9.18	-44.75	-30	-14.75
15720.00	-39.85	181	1.7	H	-7.78	-47.63	-30	-17.63
15720.00	-47.33	172	1.3	V	-7.78	-55.11	-30	-25.11

BCTC
 BCTC
 PPR
 Report

12. Transmitter Unwanted Emissions In The Out-Of-Band Domain

12.1 Block Diagram Of Test Setup

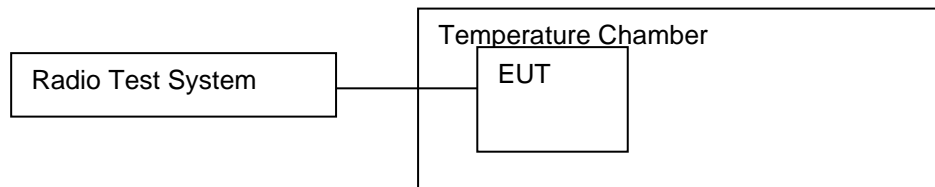

12.2 Limit

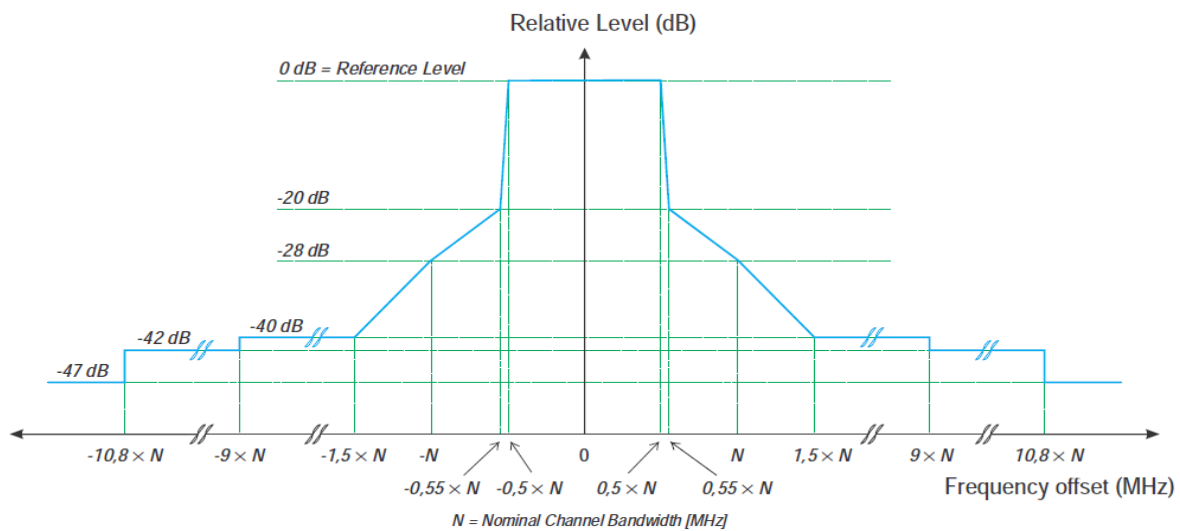

12.3 Test Procedure

The UUT shall be configured for continuous transmit mode (duty cycle equal to 100 %). If this is not possible, then option 2 shall be used.

Step 1: Determination of the reference average power level.

- Spectrum analyzer settings:
 - Resolution bandwidth: 1 MHz
 - Video bandwidth: 30 kHz
 - Detector mode: Peak
 - Trace mode: Video Average
 - Sweep Time: Coupled
 - Centre Frequency: Centre frequency of the channel being tested
 - Span: 2 × Nominal Channel Bandwidth

• Use the marker to find the highest average power level of the power envelope of the UUT. This level shall be used as the reference level for the relative measurements.

Step 2: Determination of the relative average power levels.

- Adjust the frequency range of the spectrum analyzer to allow the measurement to be performed within the sub-bands 5 150 MHz to 5 350 MHz and 5 470 MHz to 5 725 MHz. No other parameter of the spectrum analyzer should be changed.
- Compare the relative power envelope of the UUT with the limits defined in clause 4.2.4.2.2.

12.4 Test Result

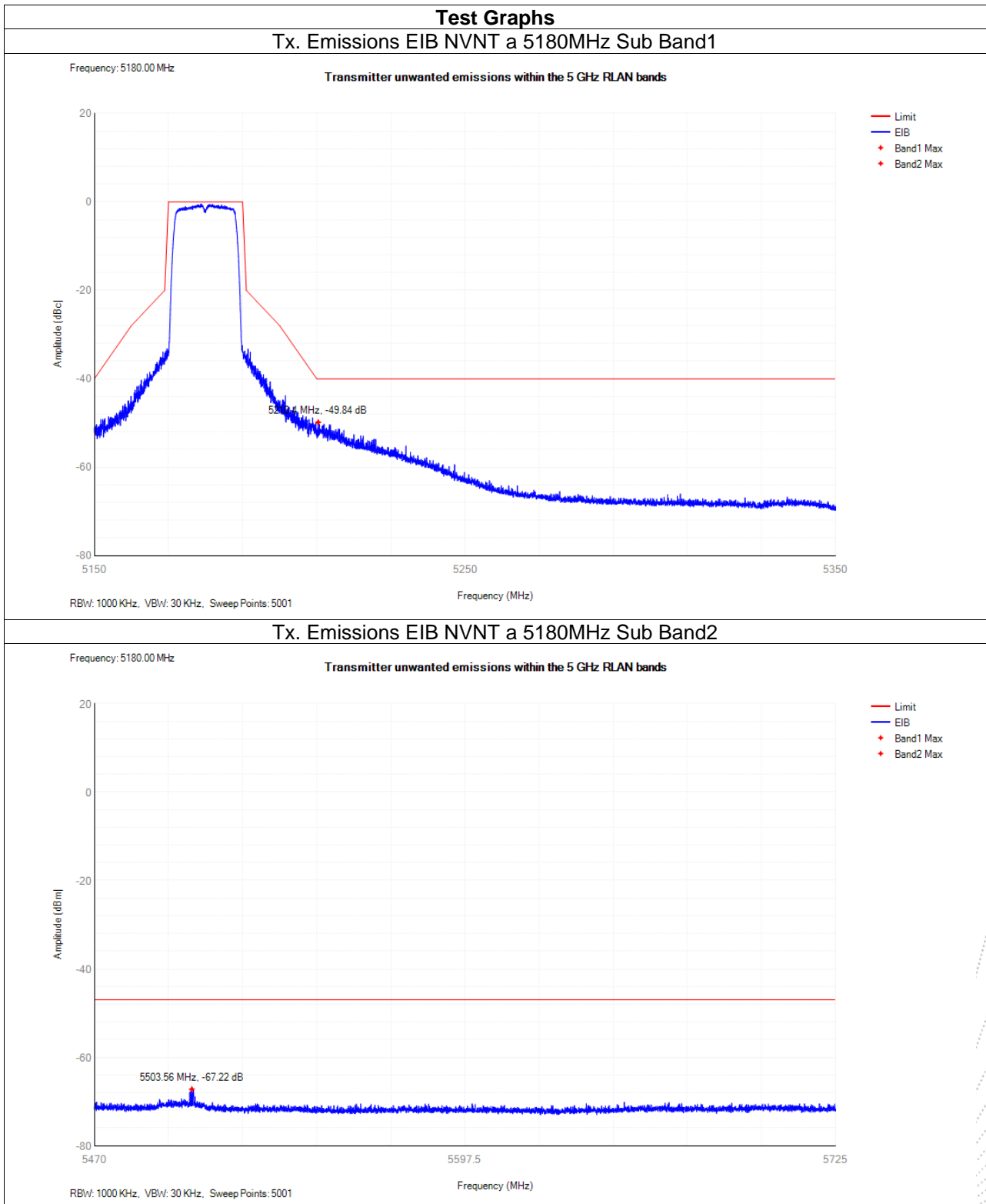

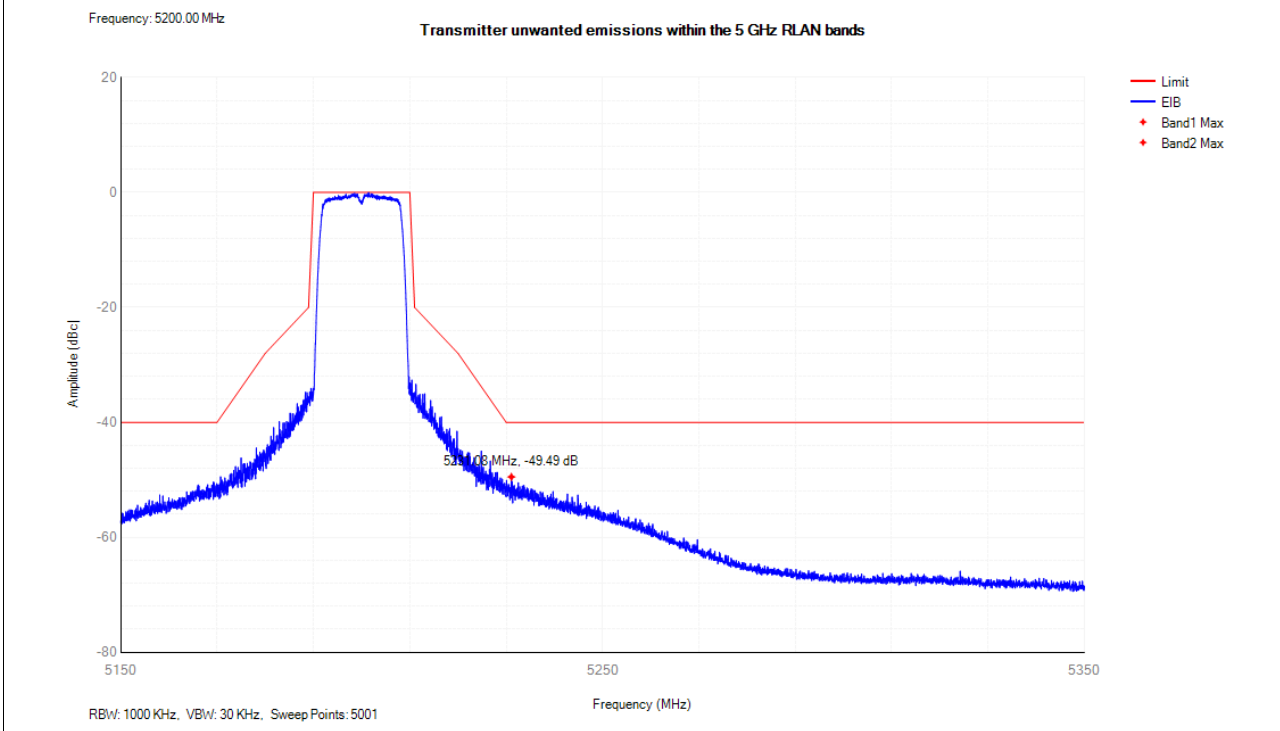
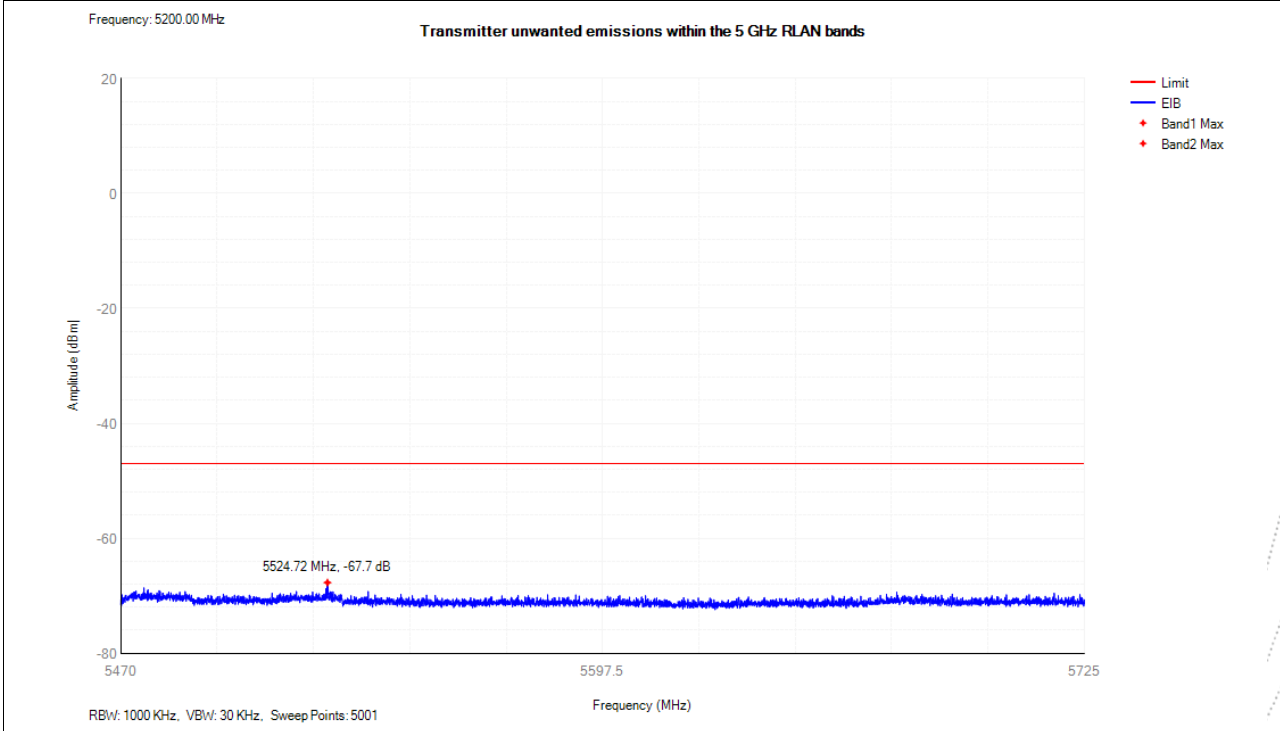
Tx. Emissions EIB NVNT a 5200MHz Sub Band1

Tx. Emissions EIB NVNT a 5200MHz Sub Band2

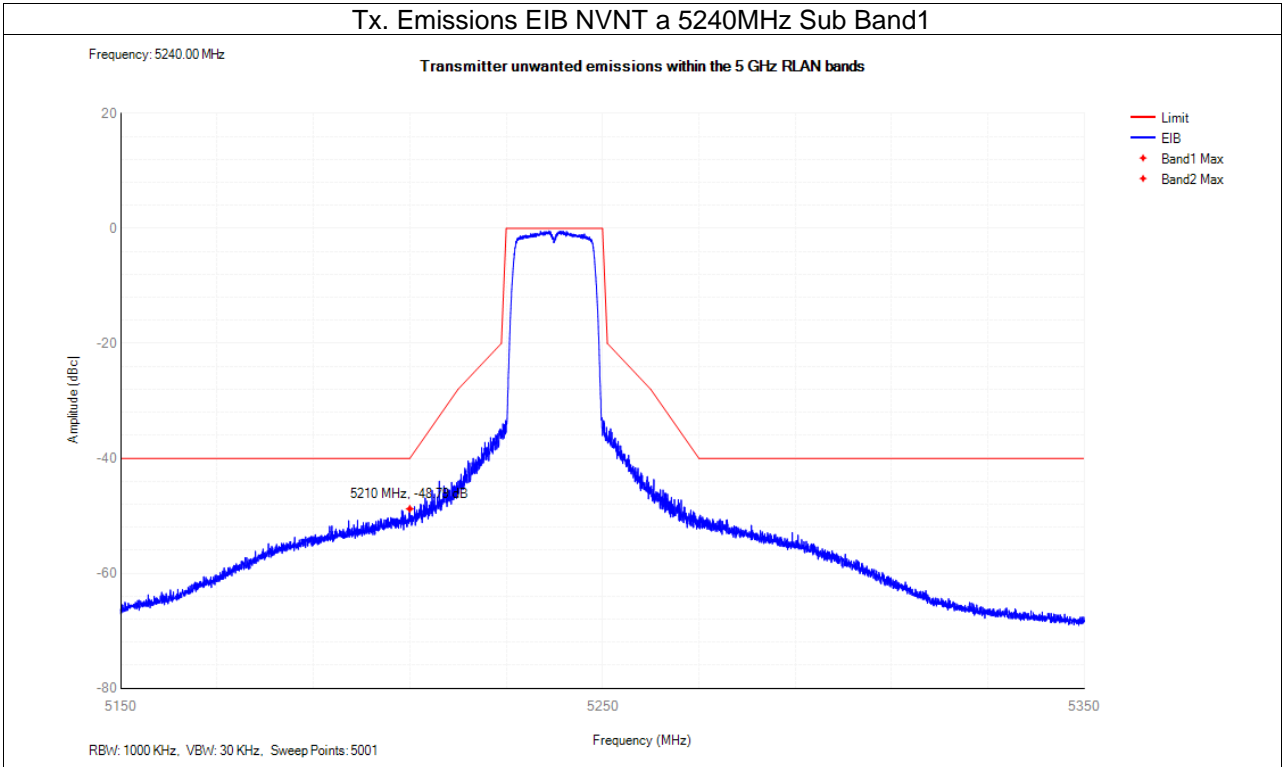
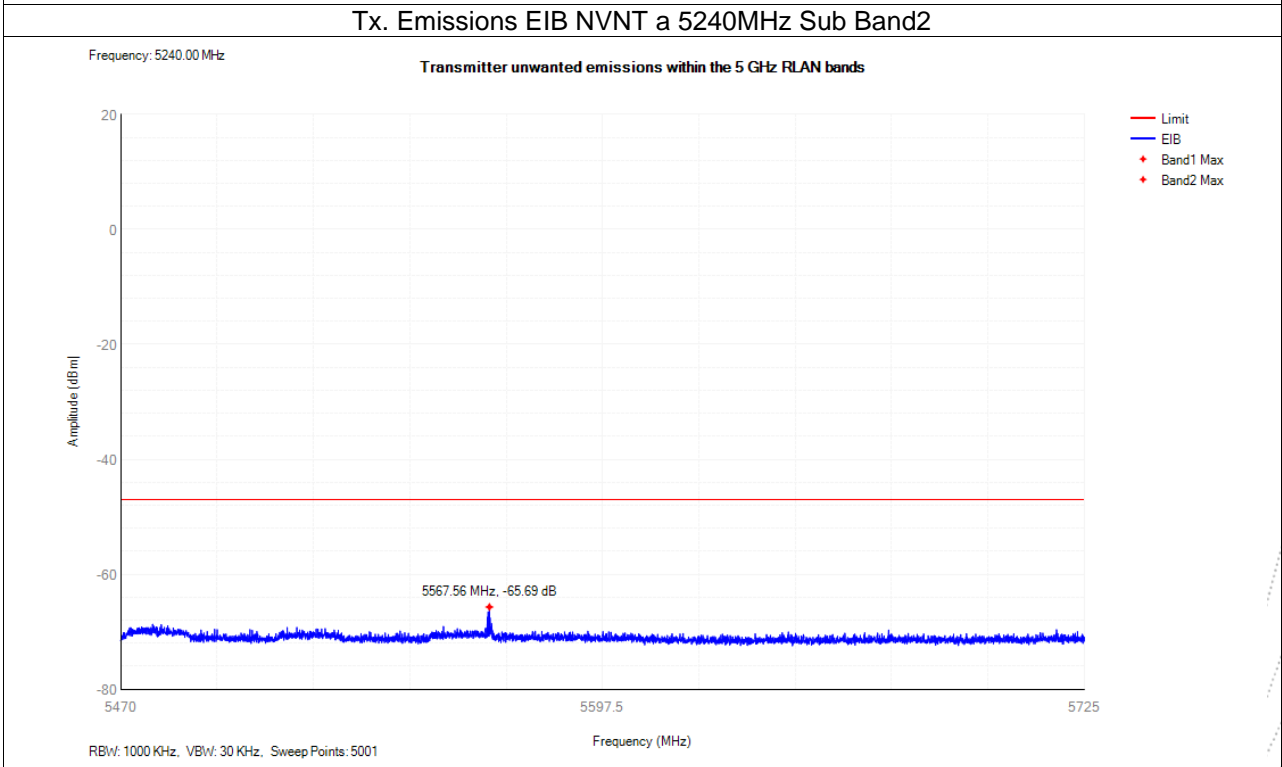
CO., LTD

Tx. Emissions EIB NVNT a 5240MHz Sub Band1

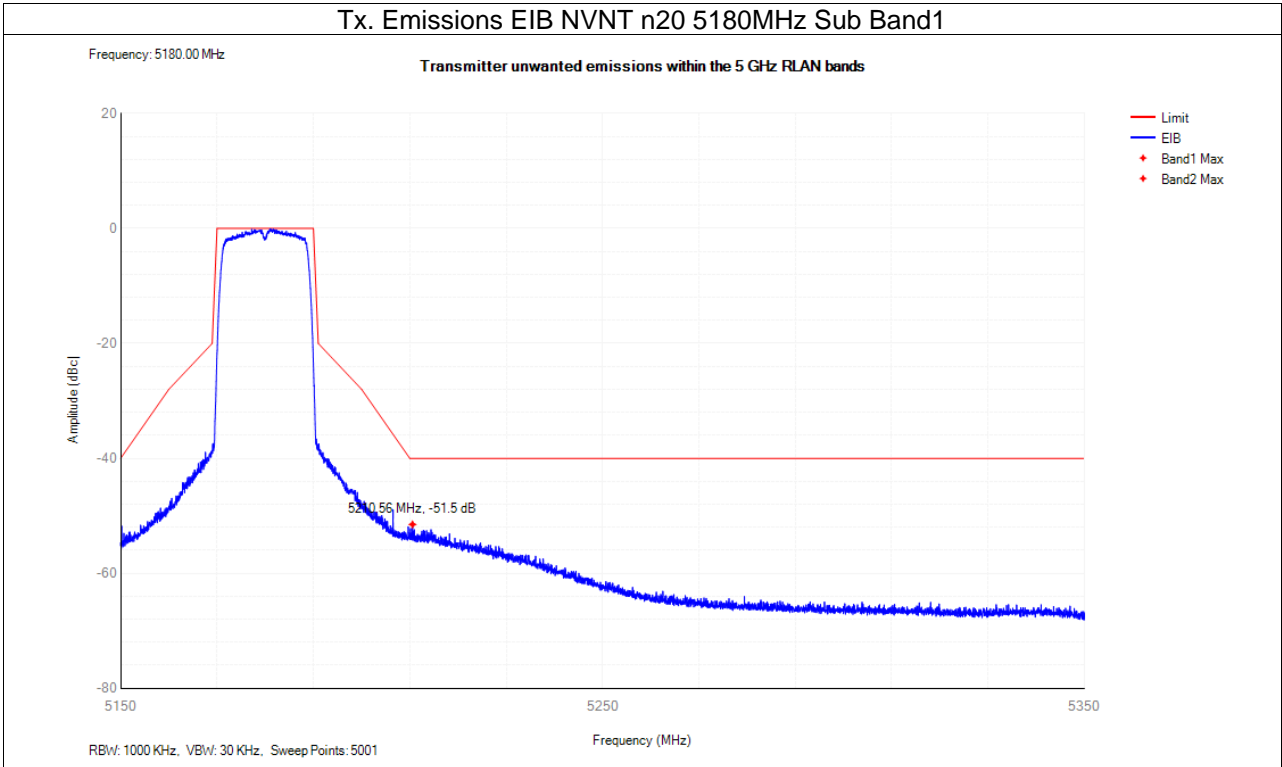
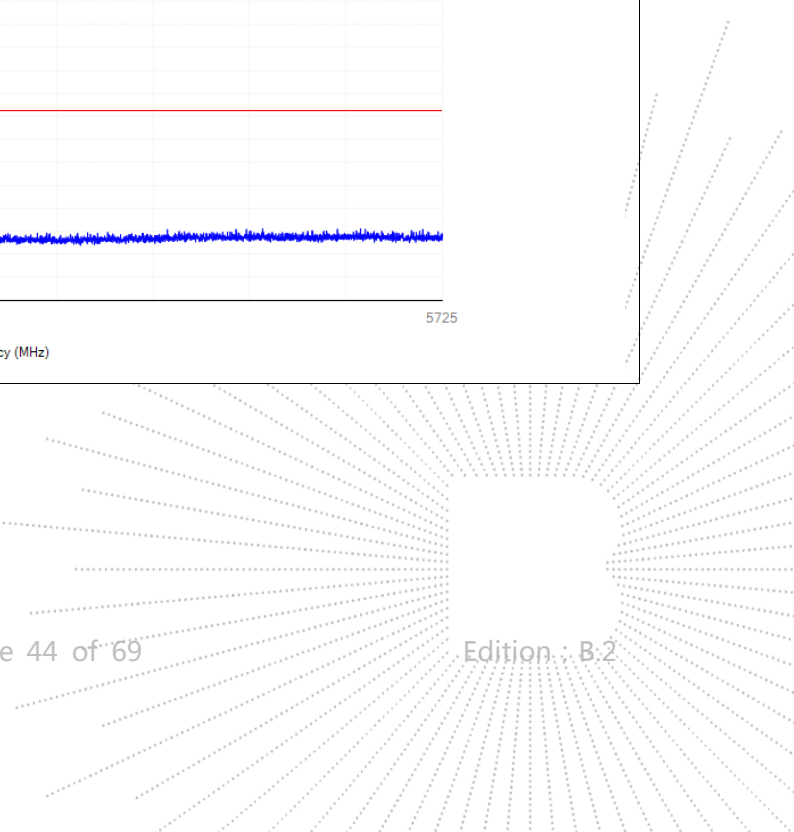
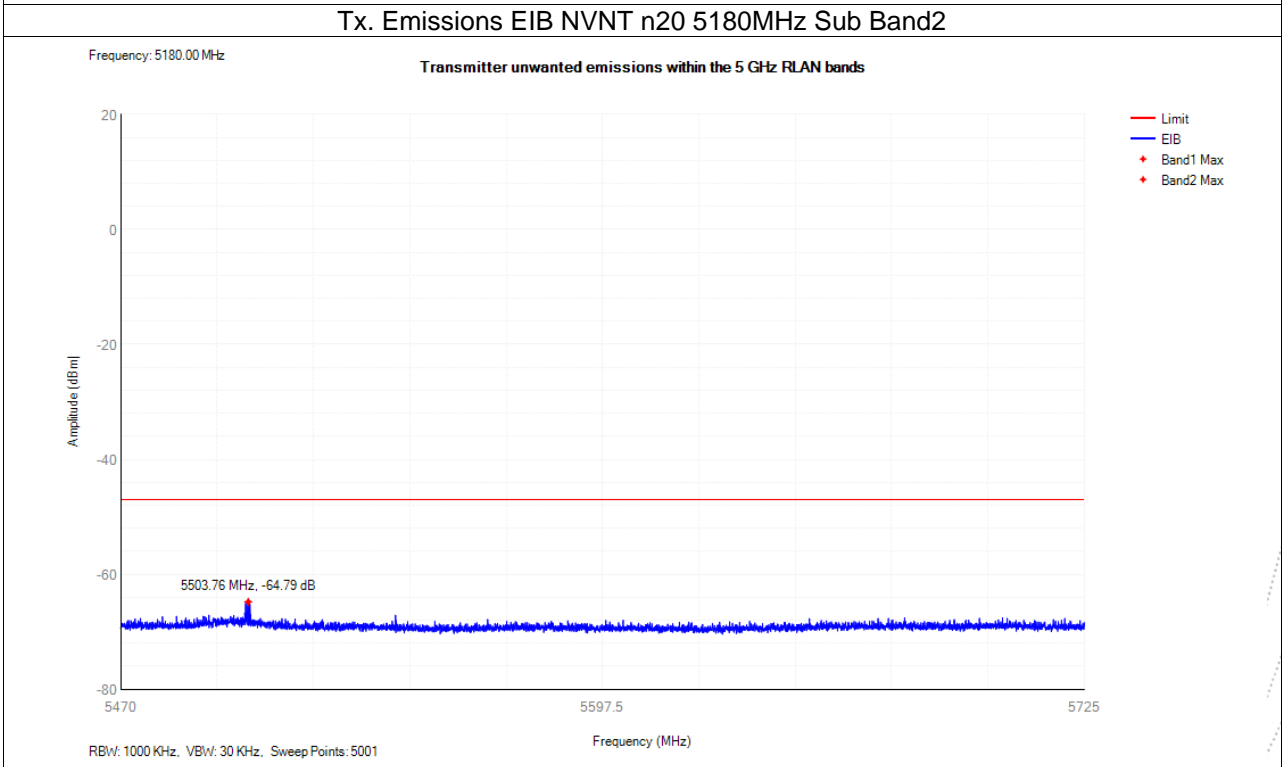
Tx. Emissions EIB NVNT a 5240MHz Sub Band2

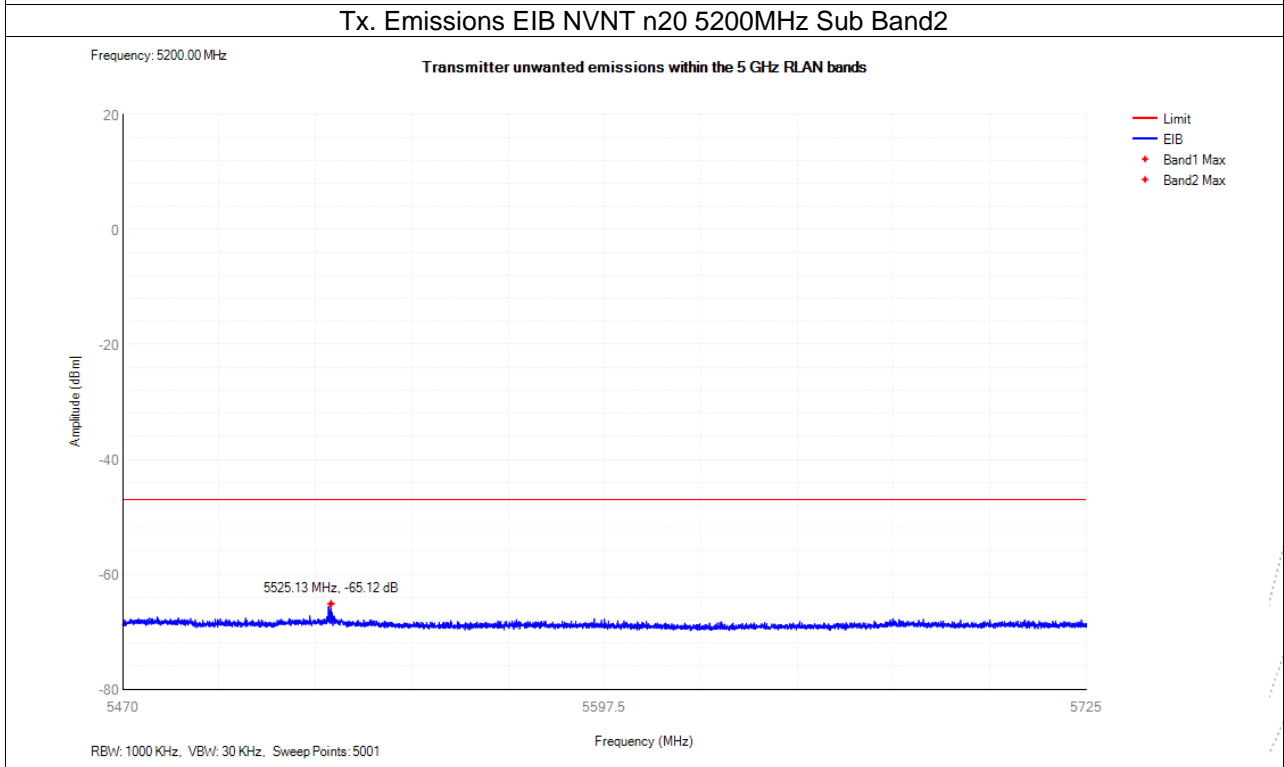
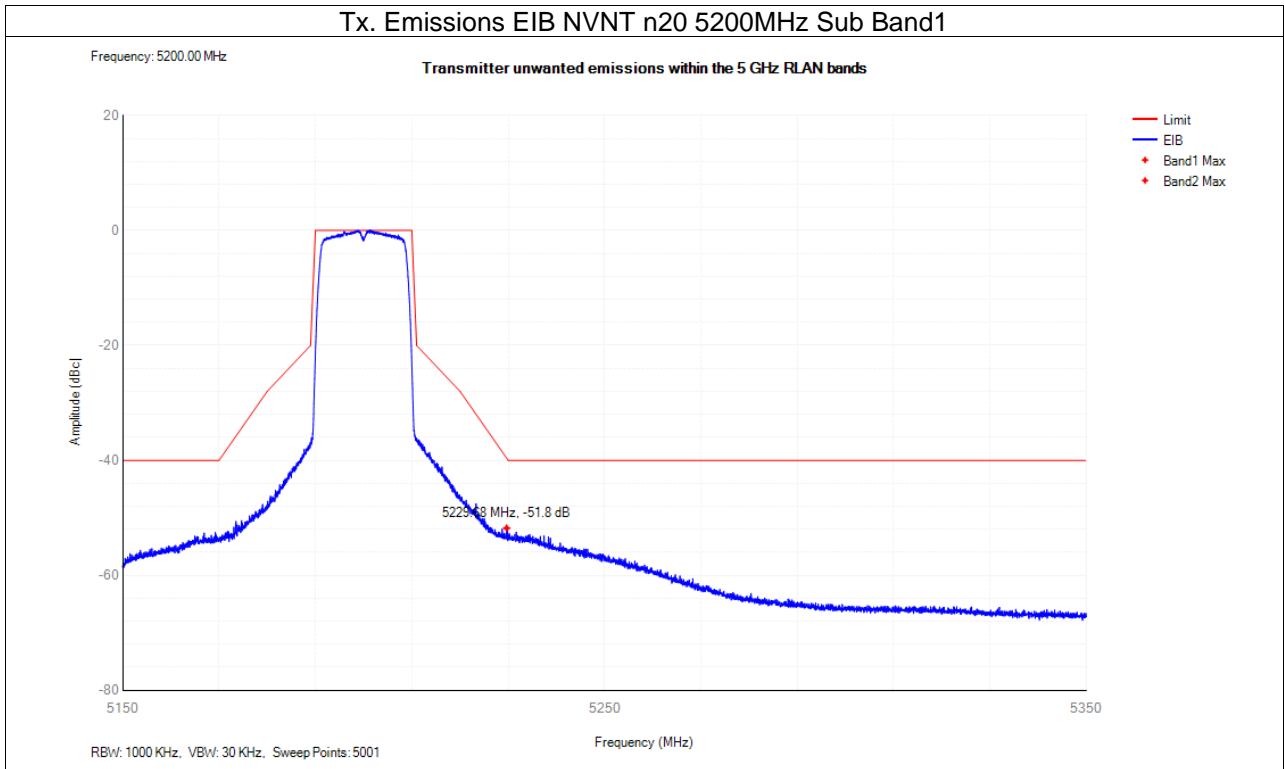
SHENZHEN

Tx. Emissions EIB NVNT n20 5180MHz Sub Band1

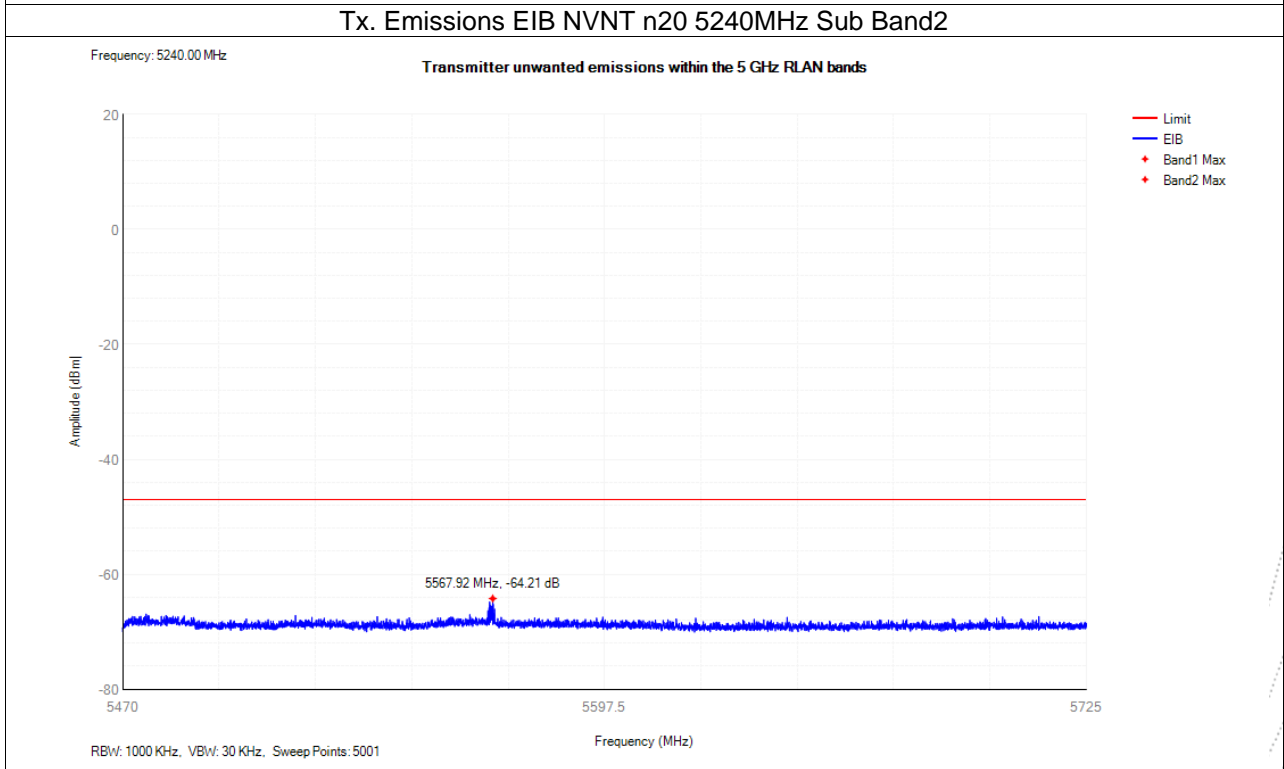
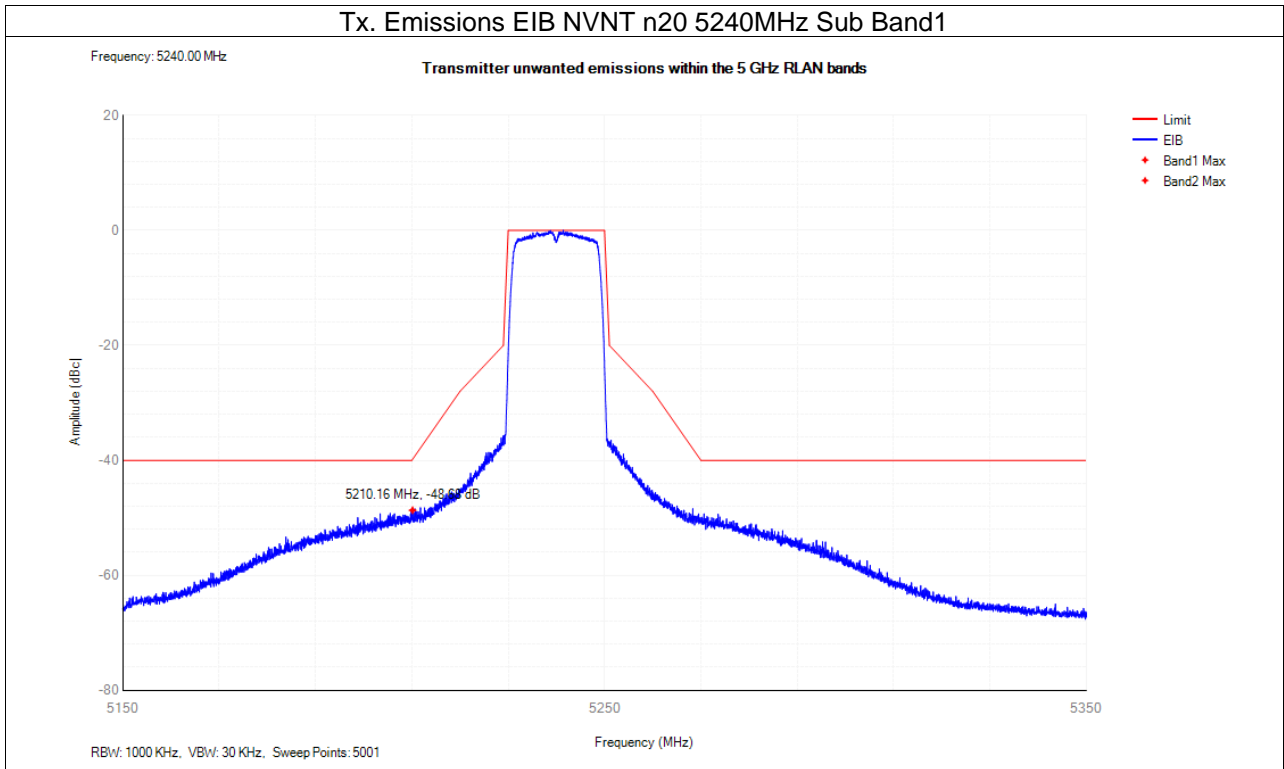
Tx. Emissions EIB NVNT n20 5180MHz Sub Band2

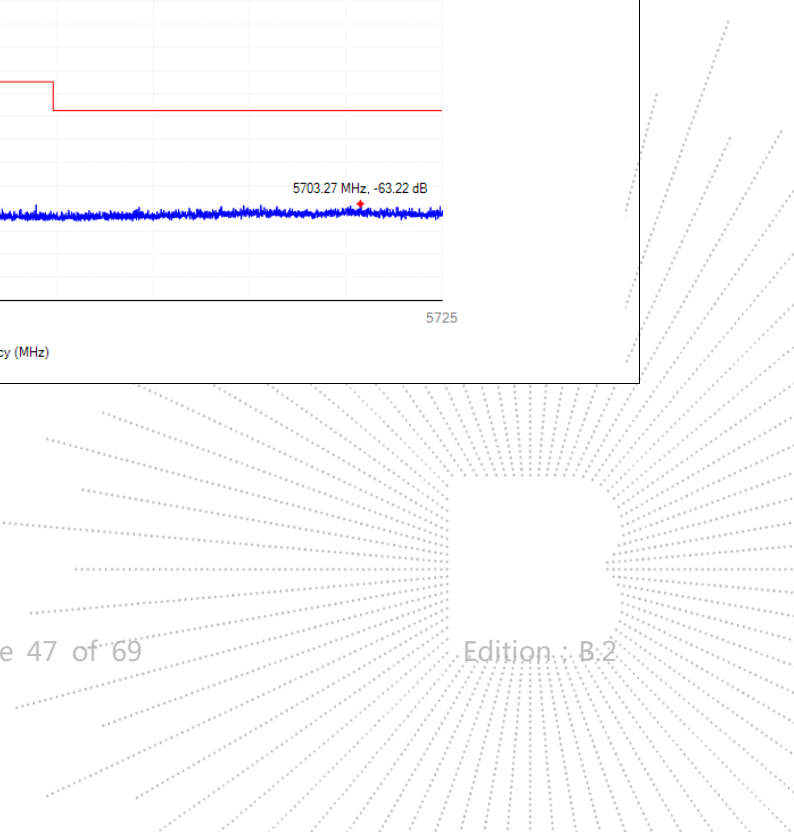
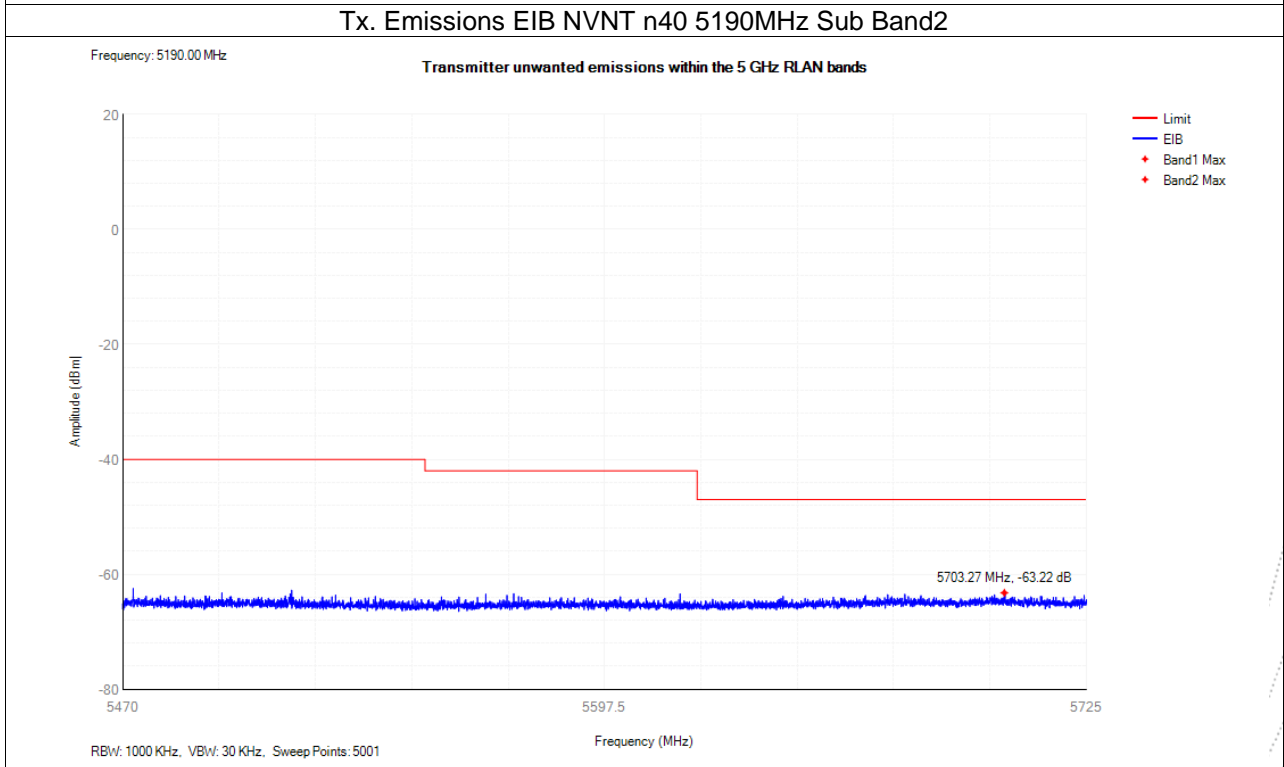
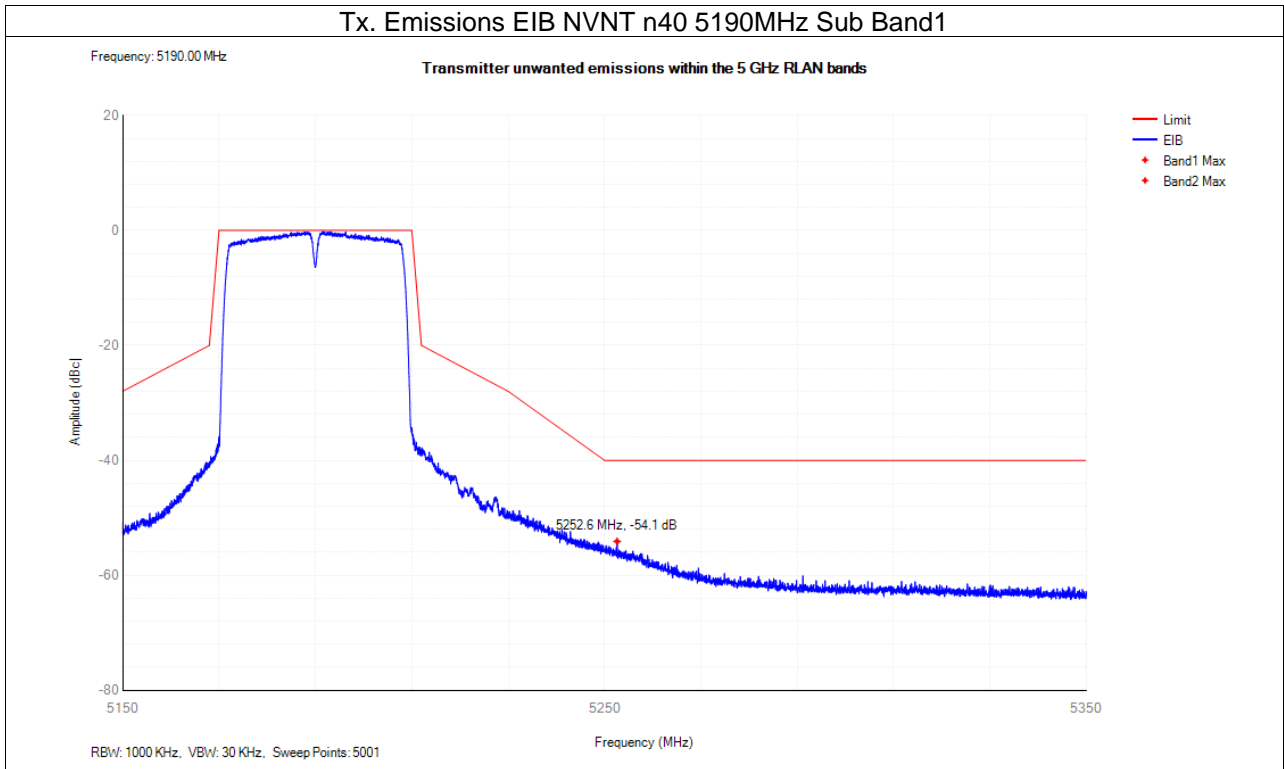



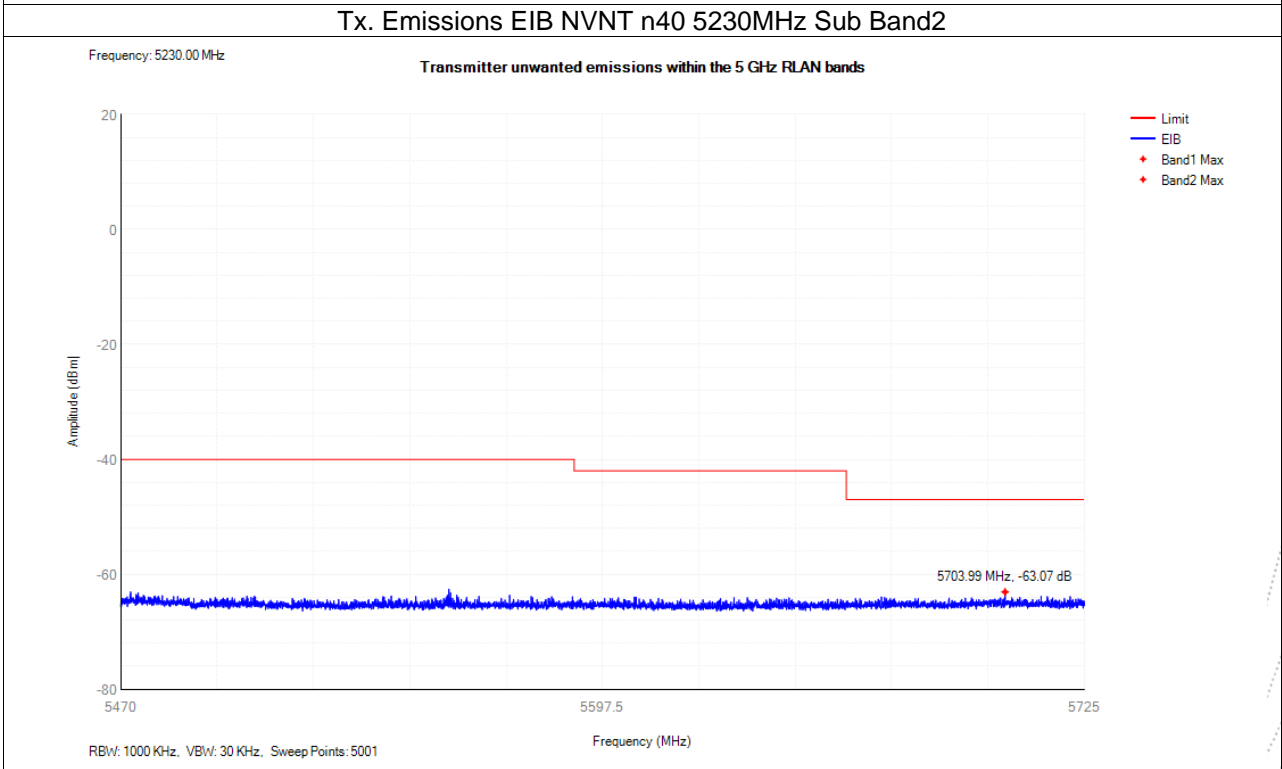
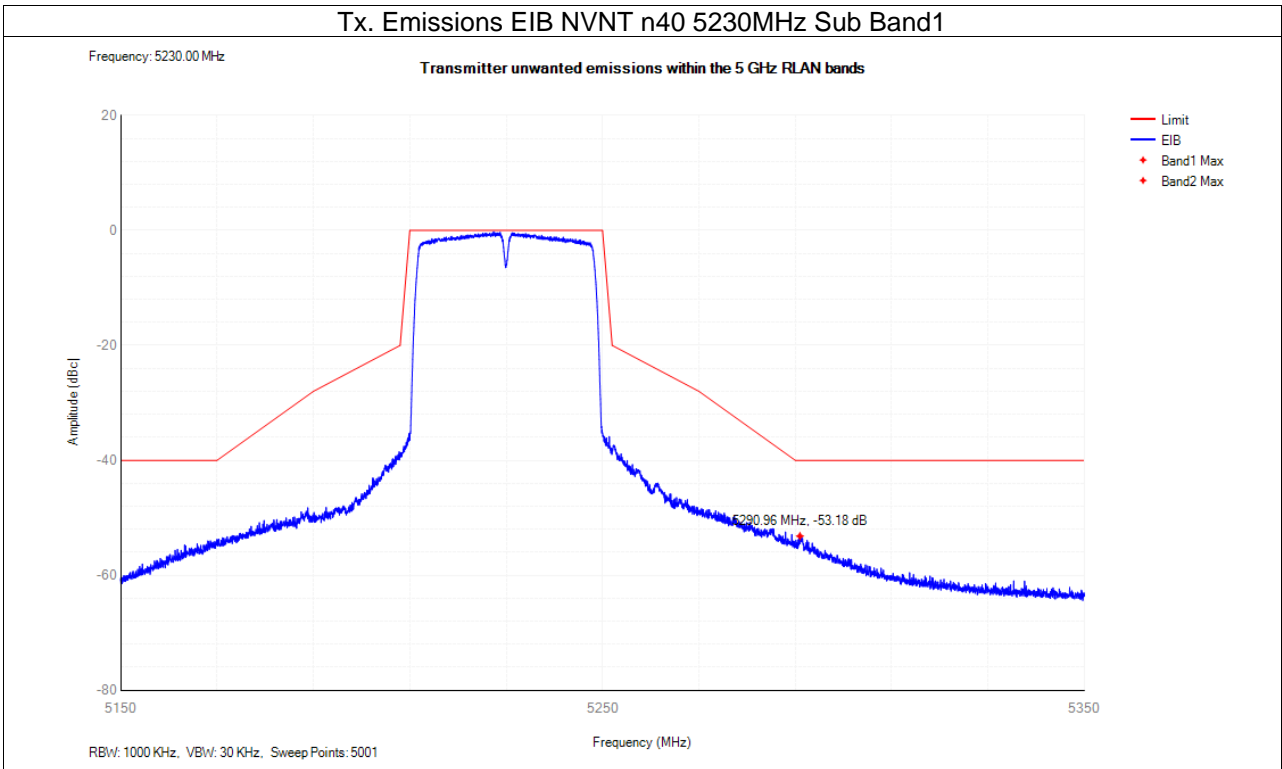



CO., LTD

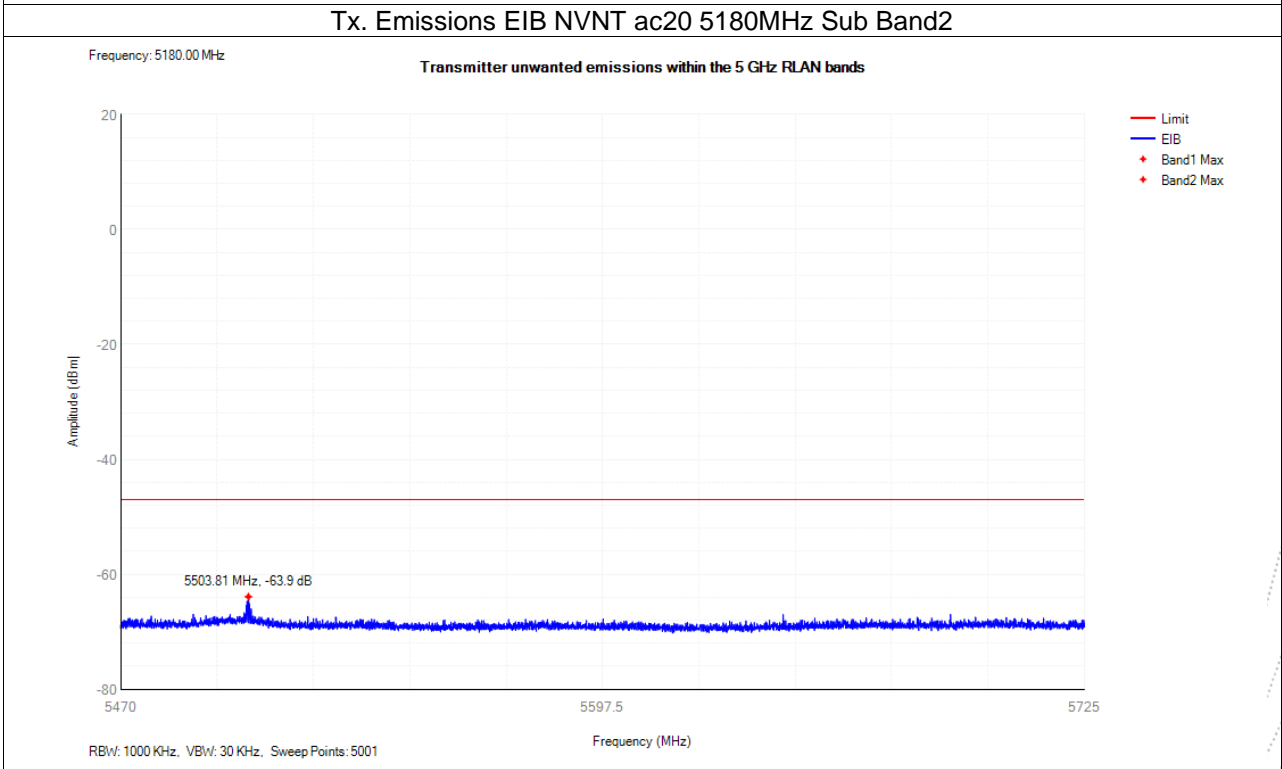
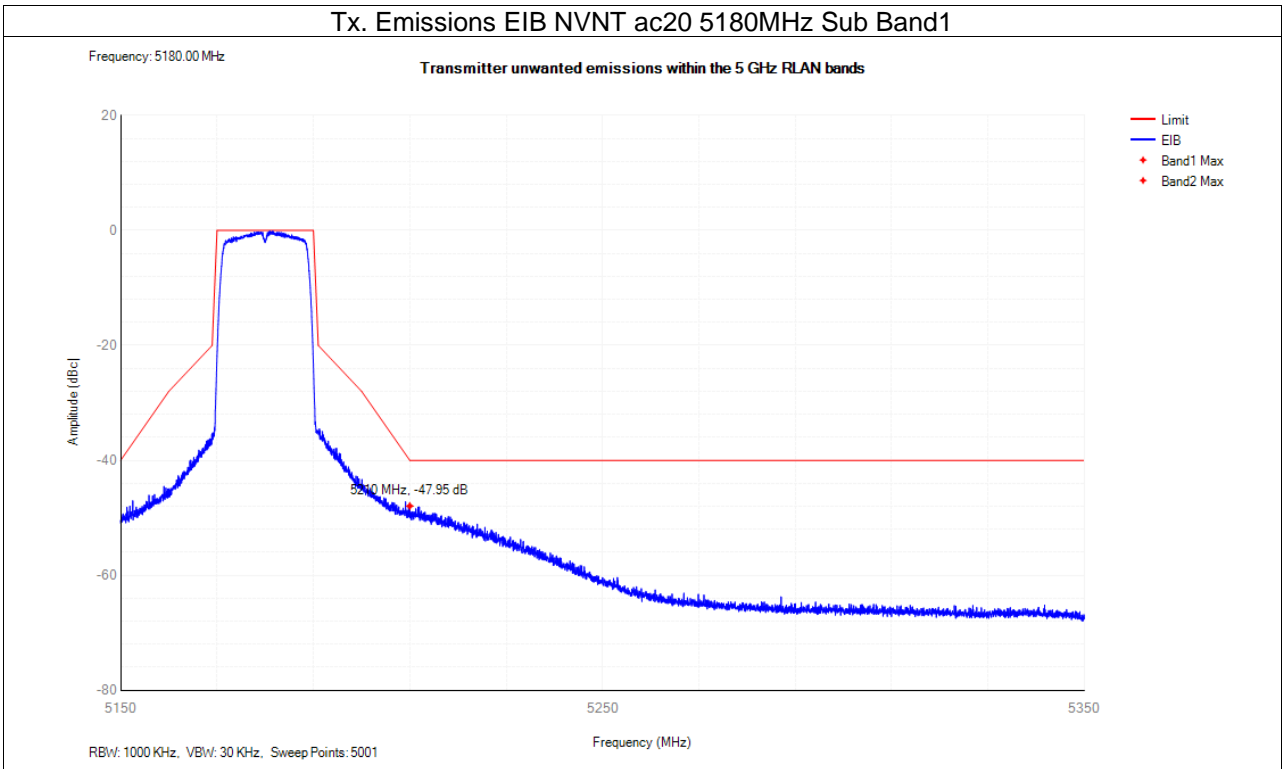

SHENZHEN

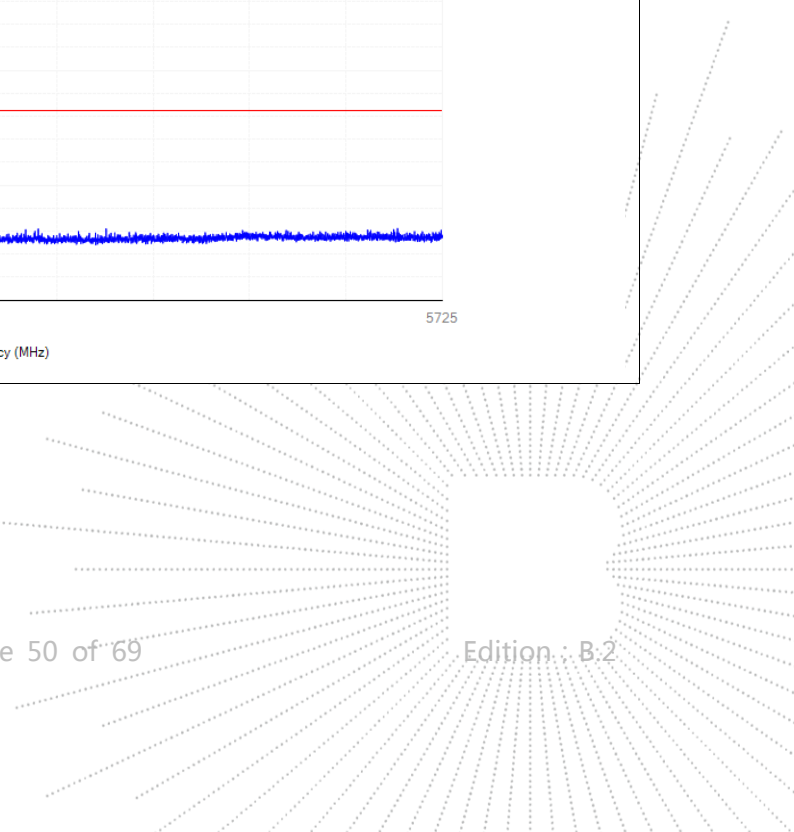
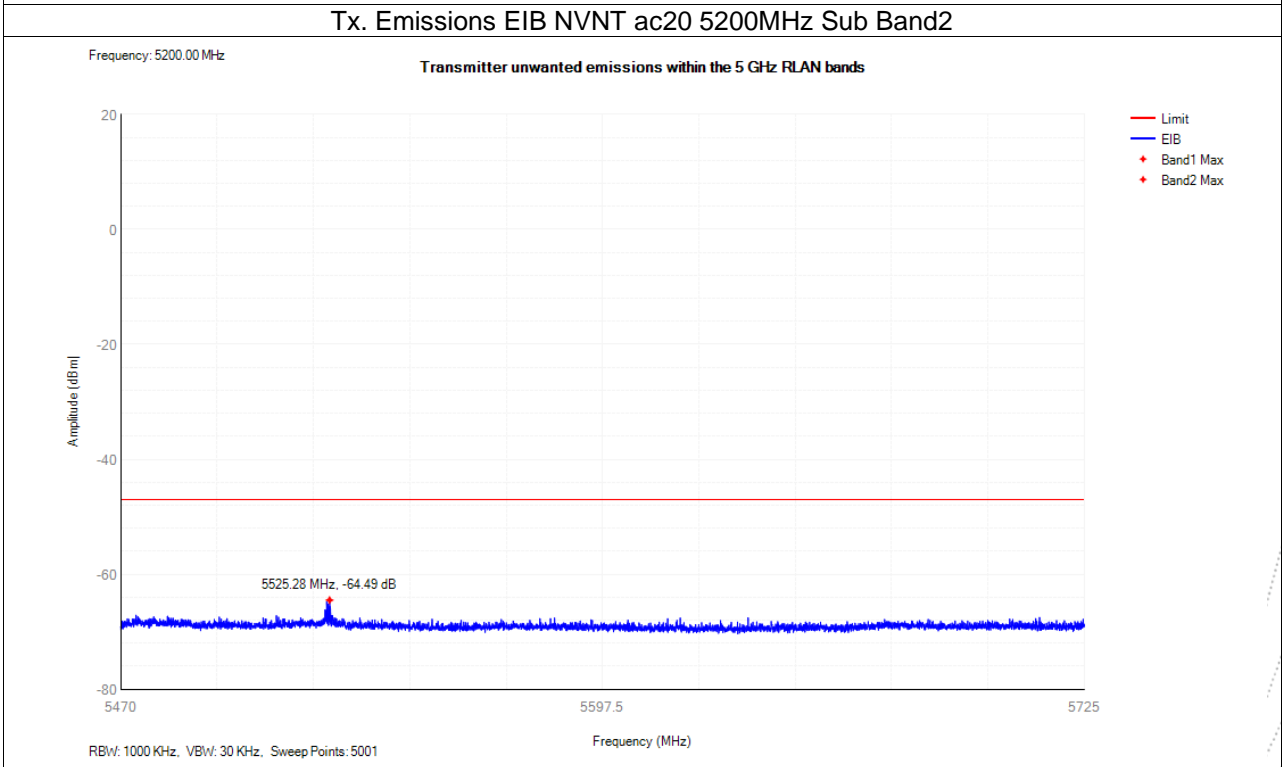
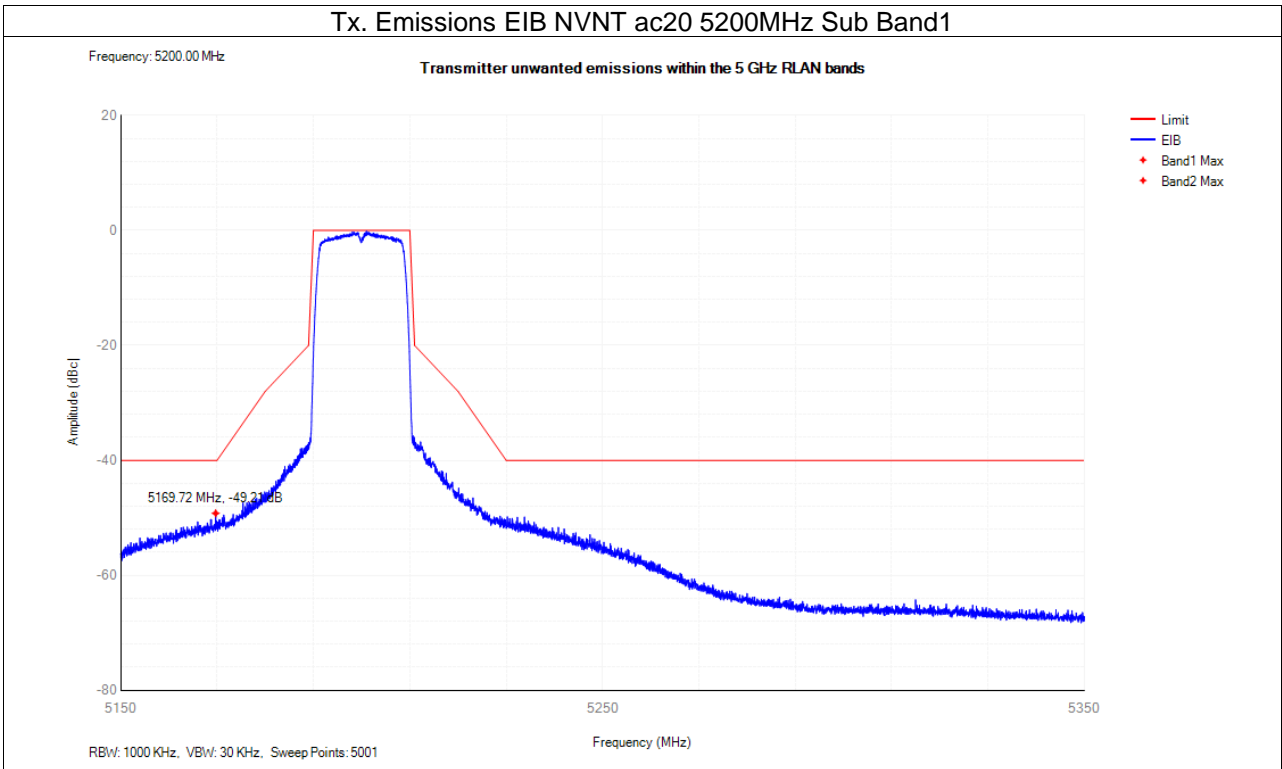

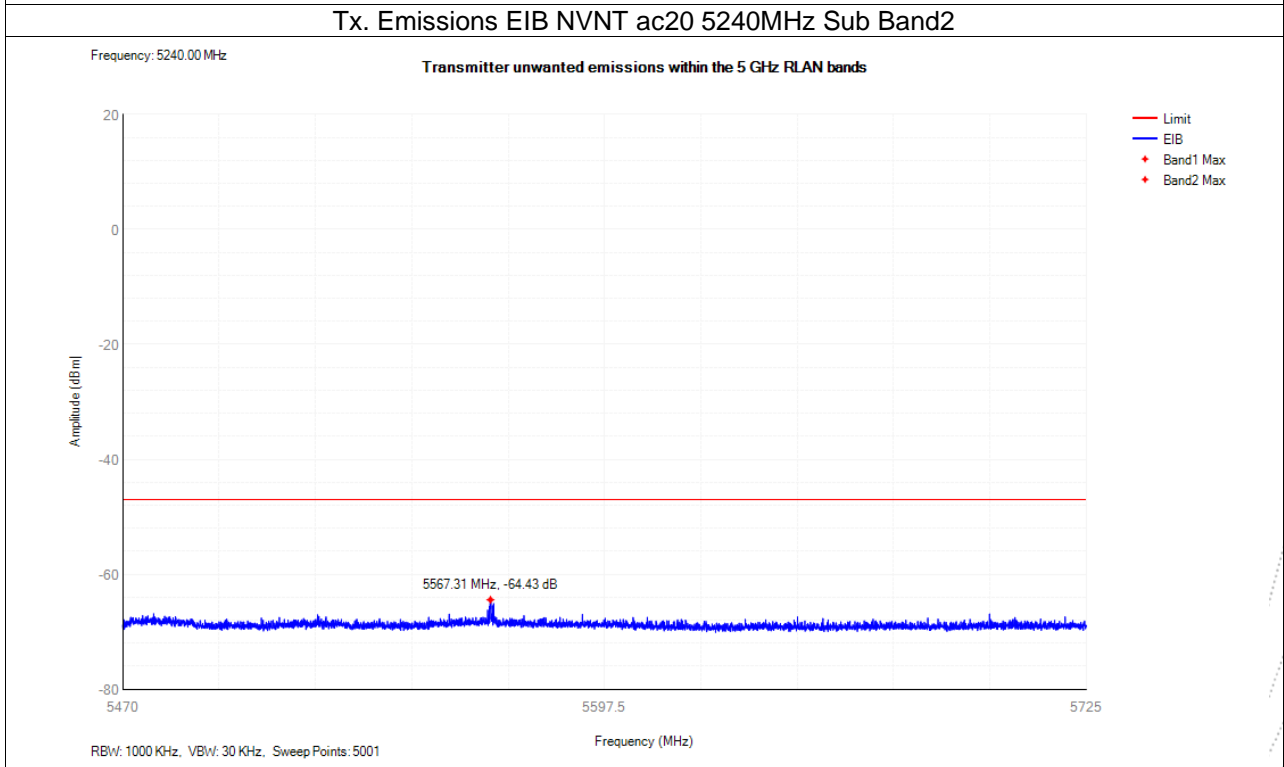
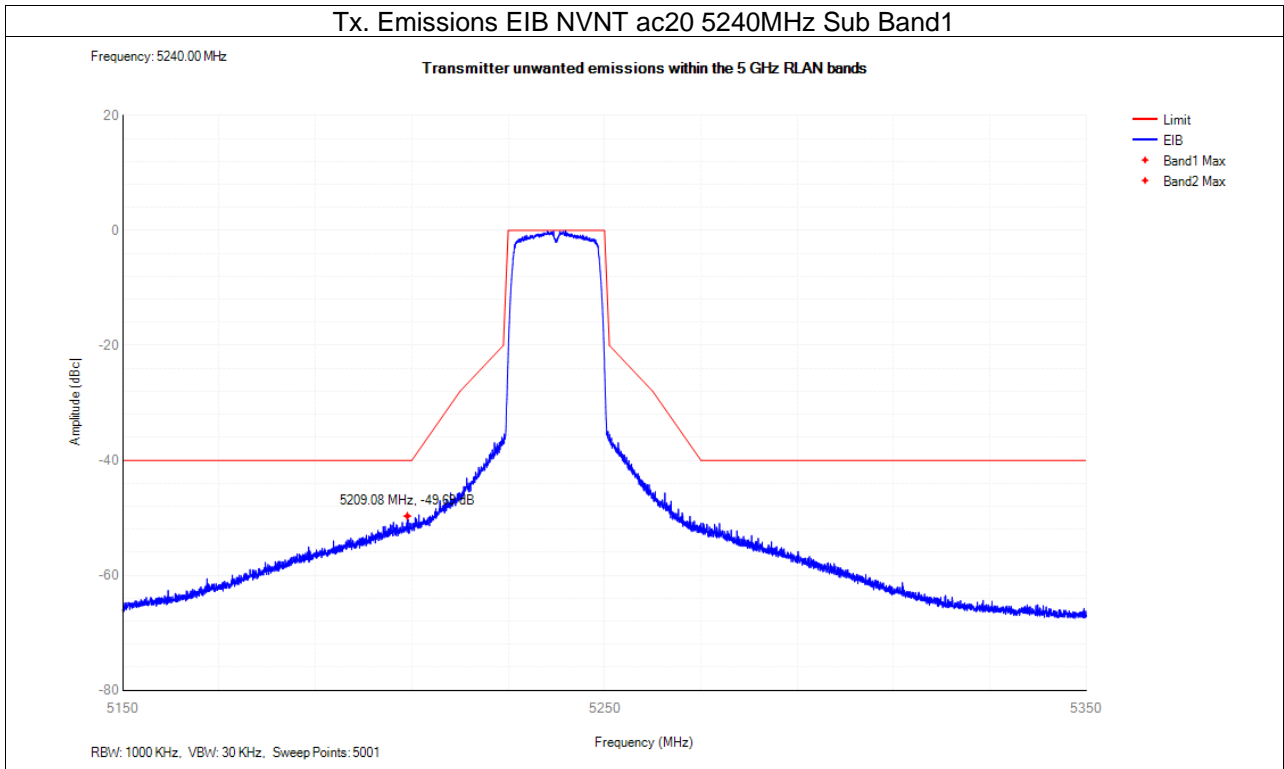

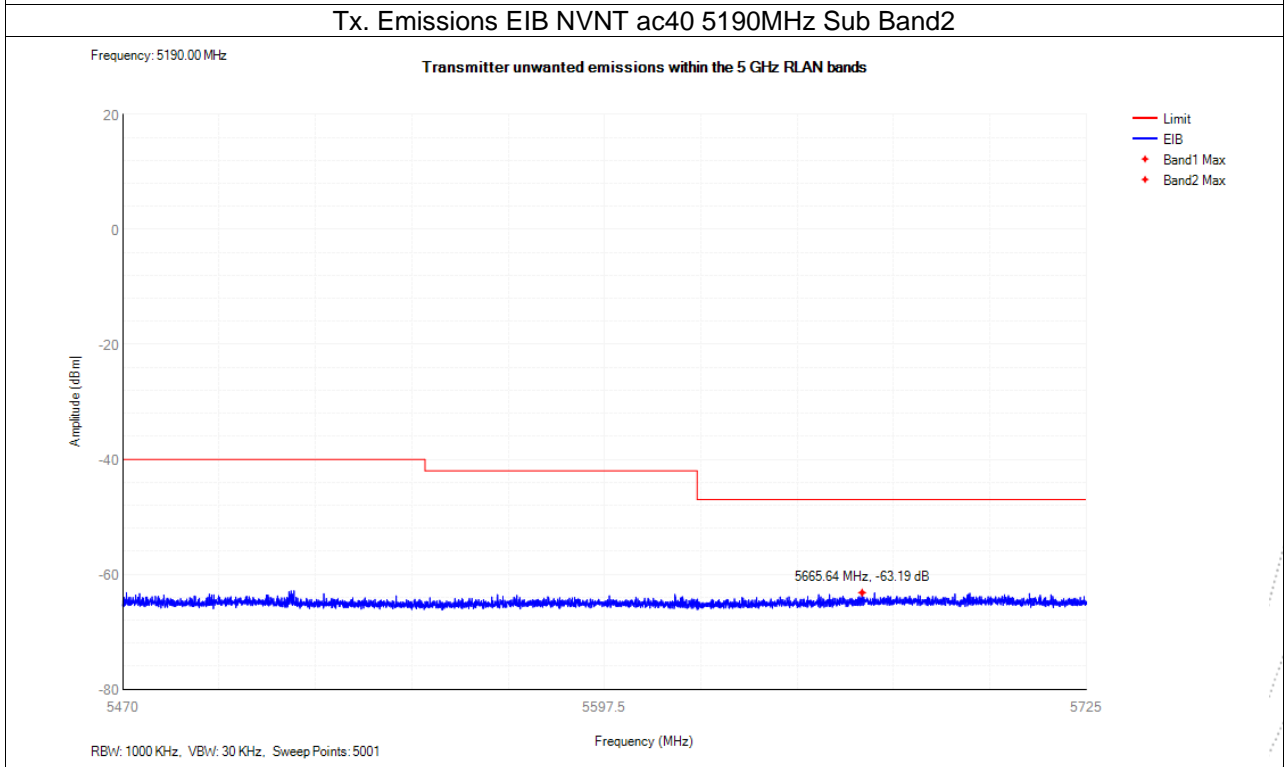
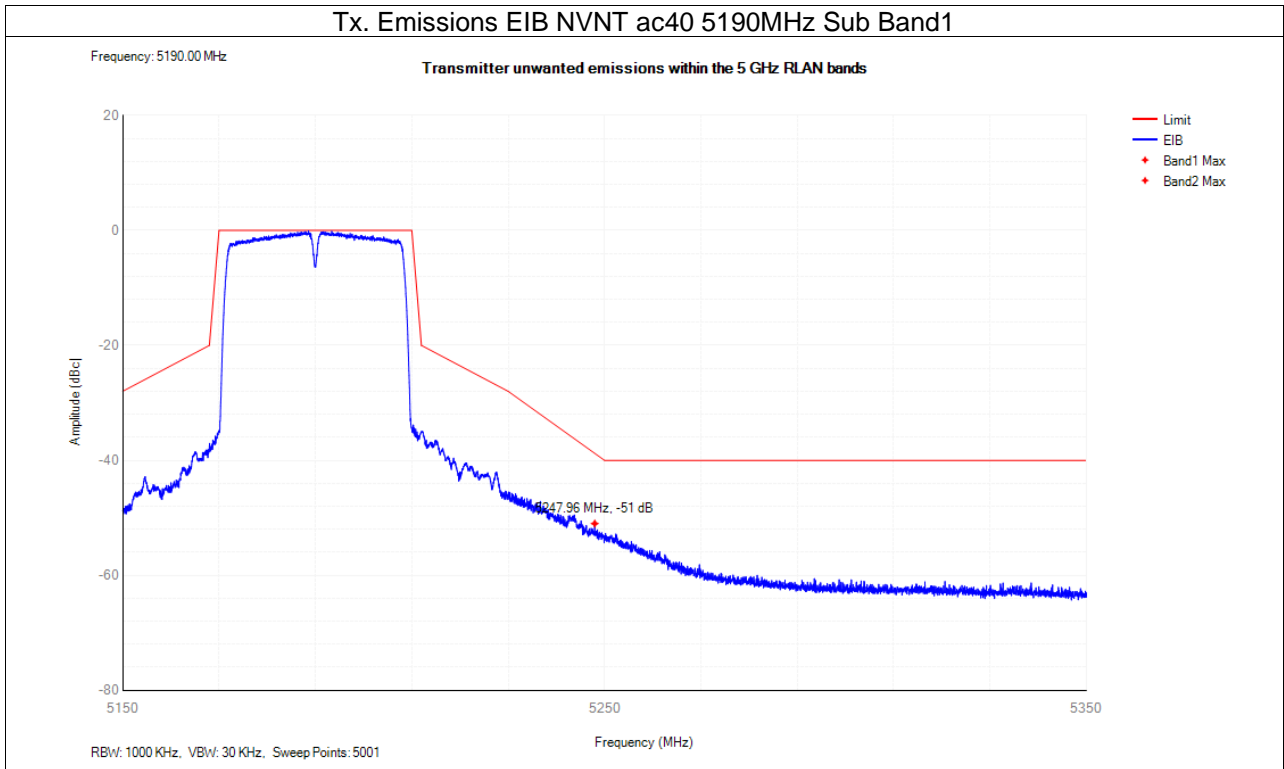

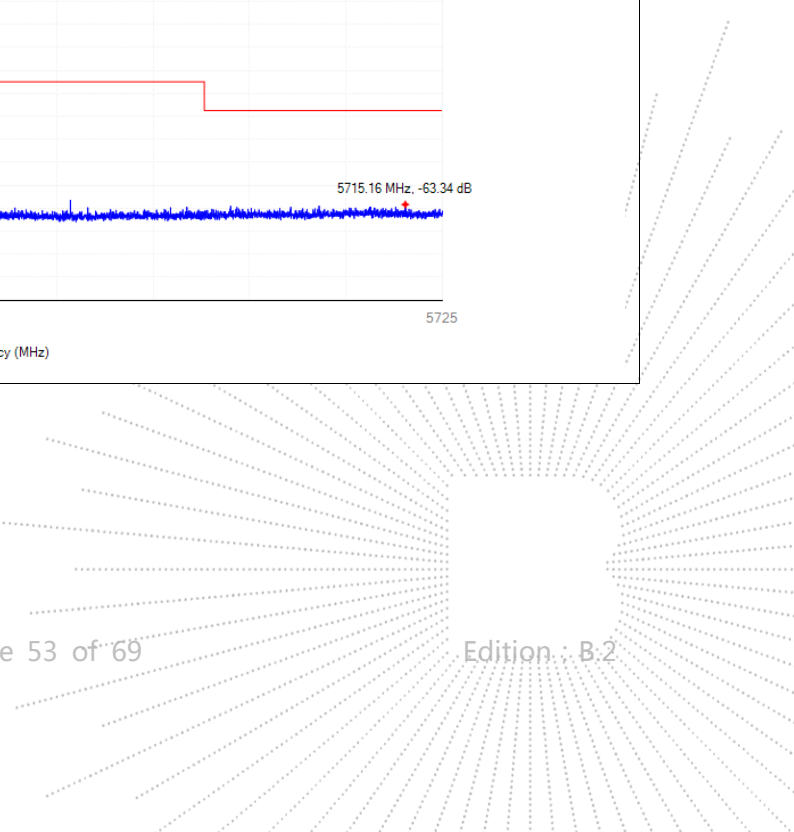
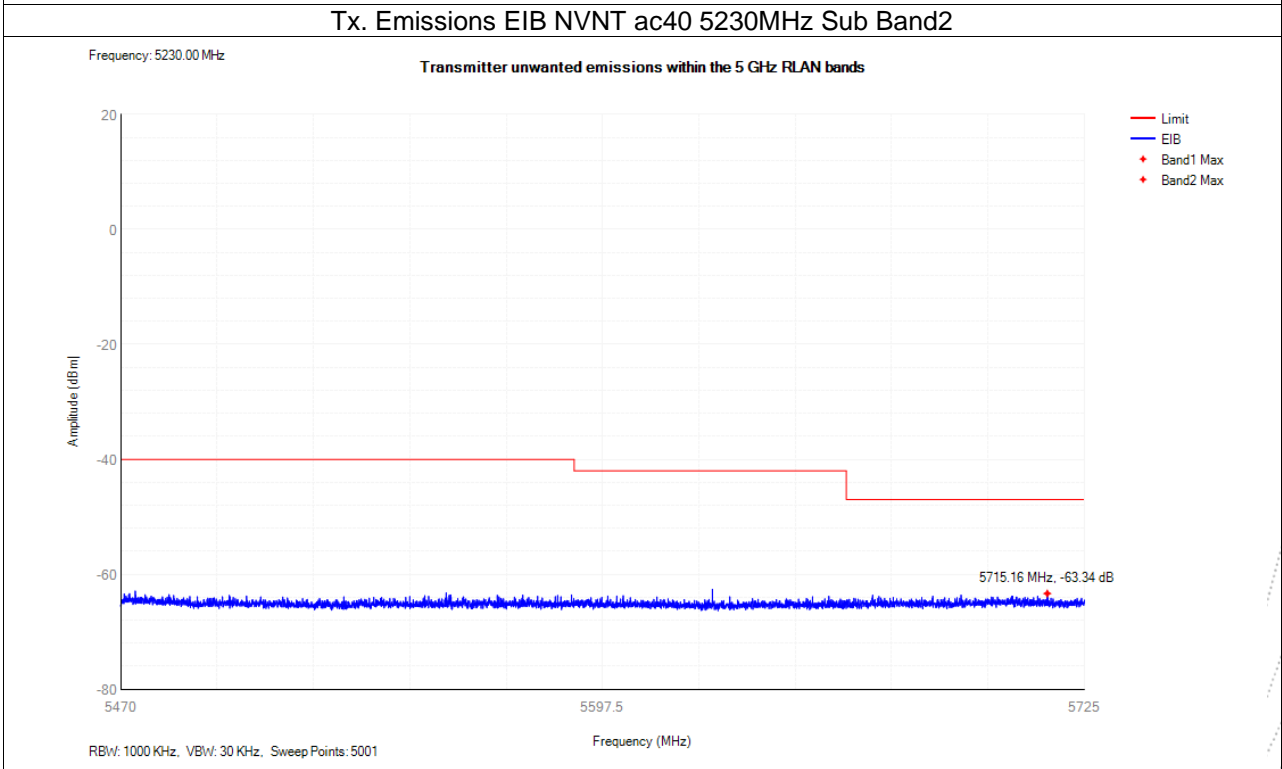
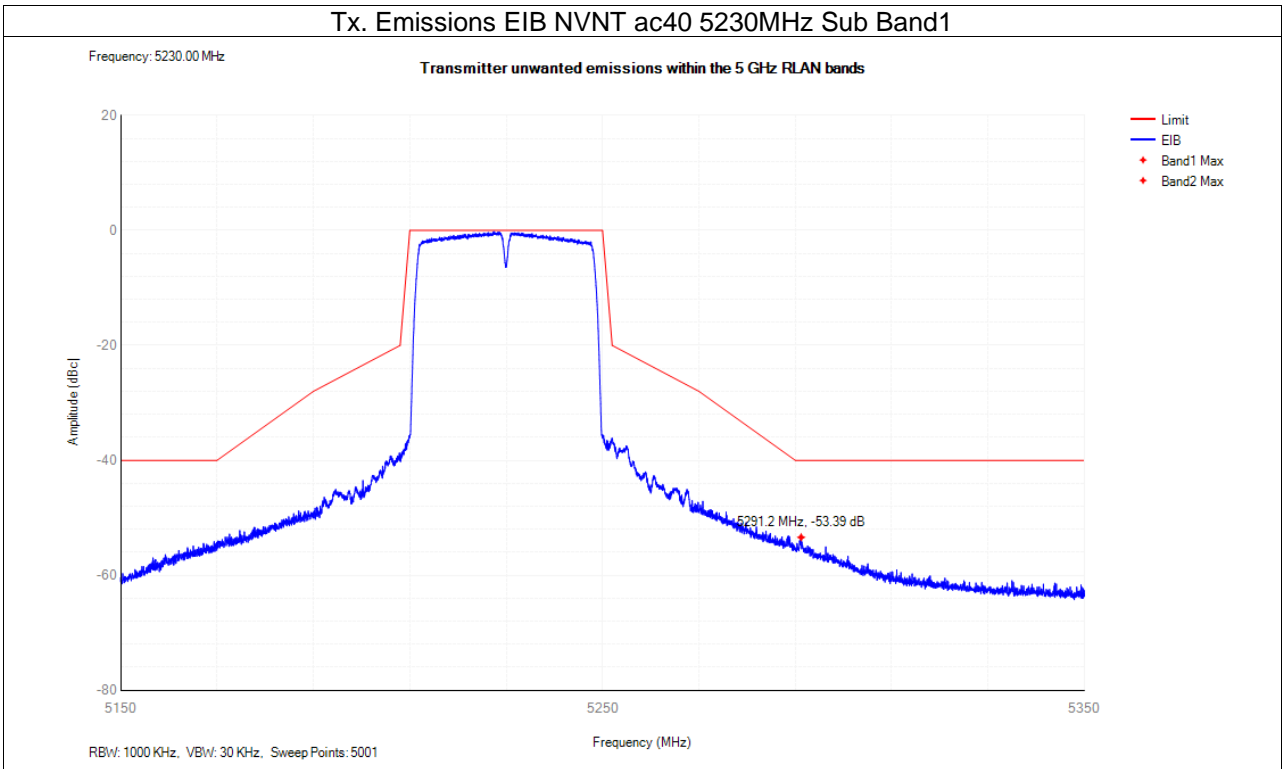

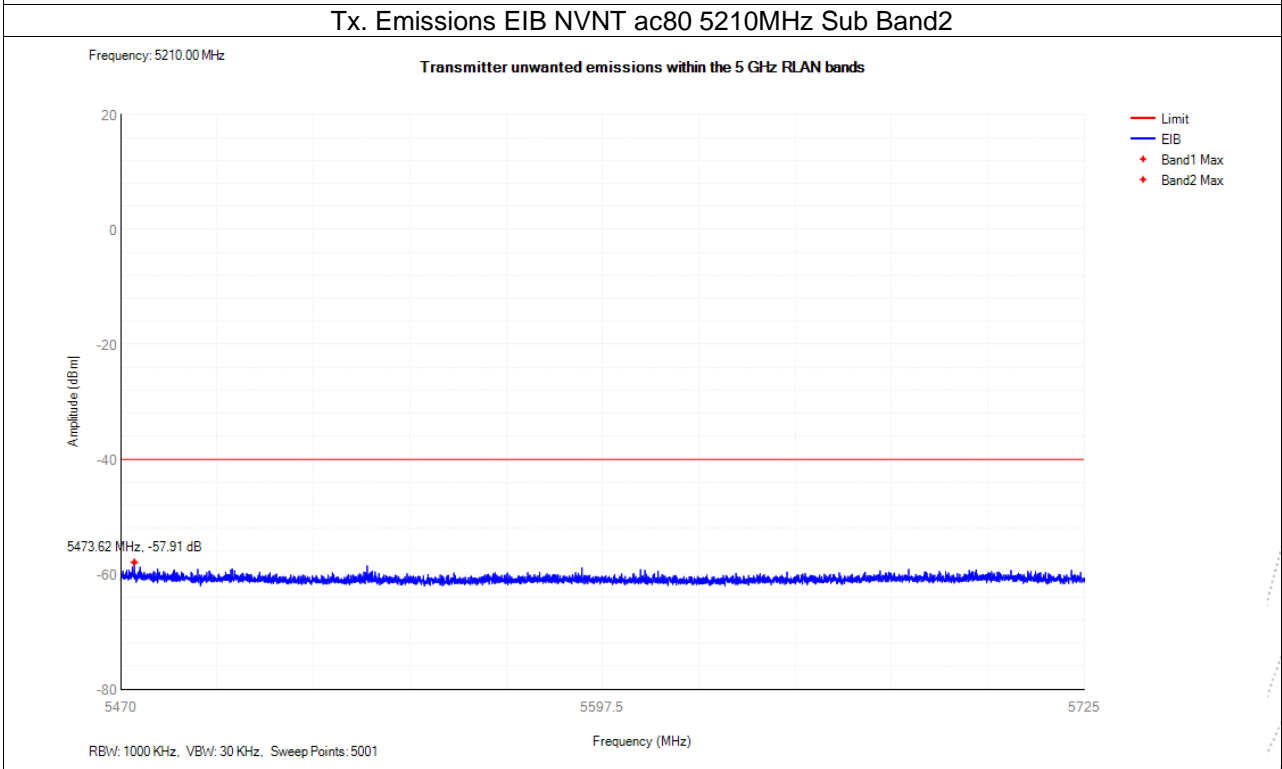
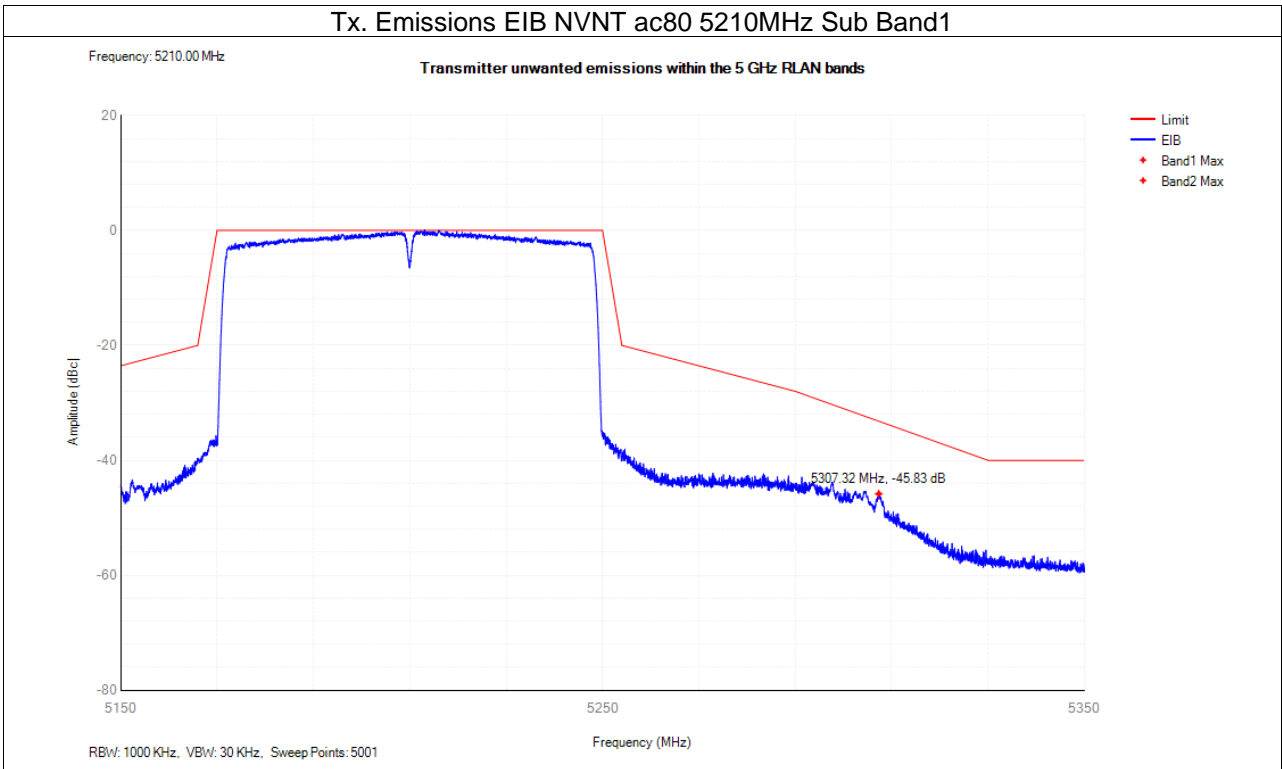

CO., LTD

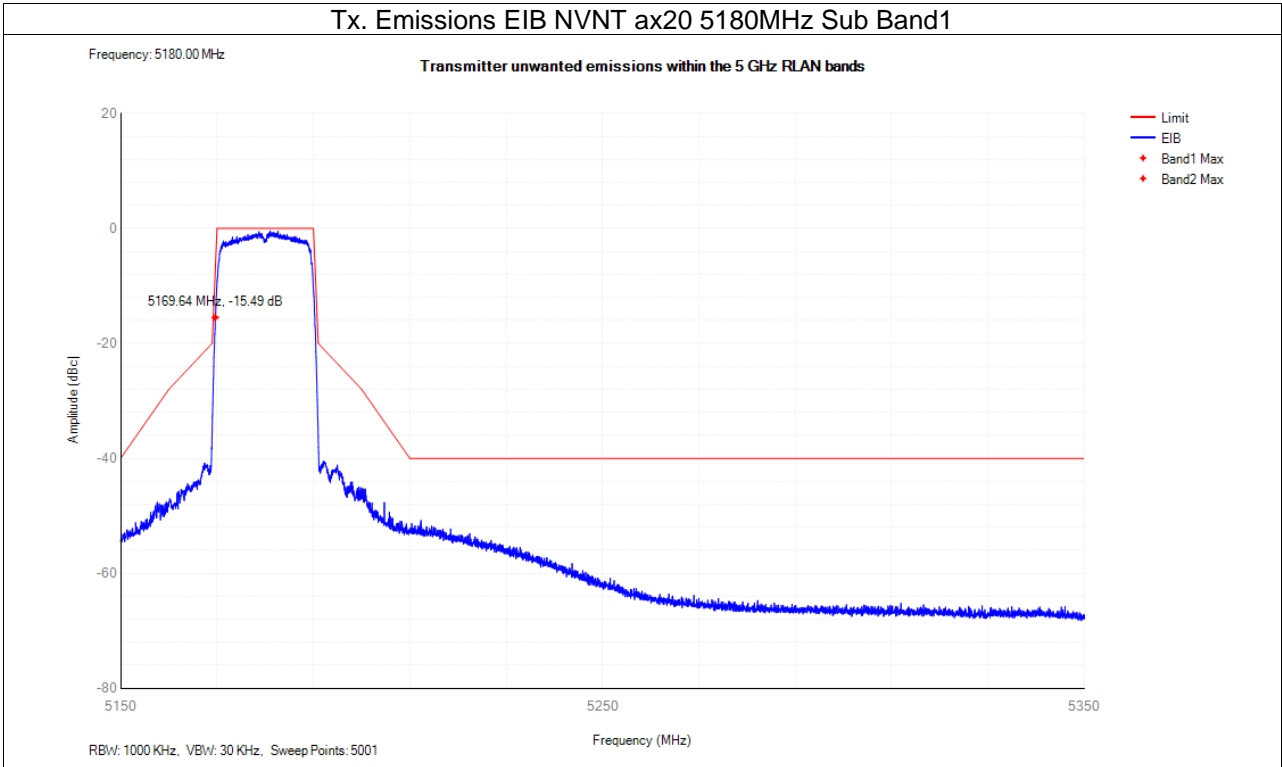
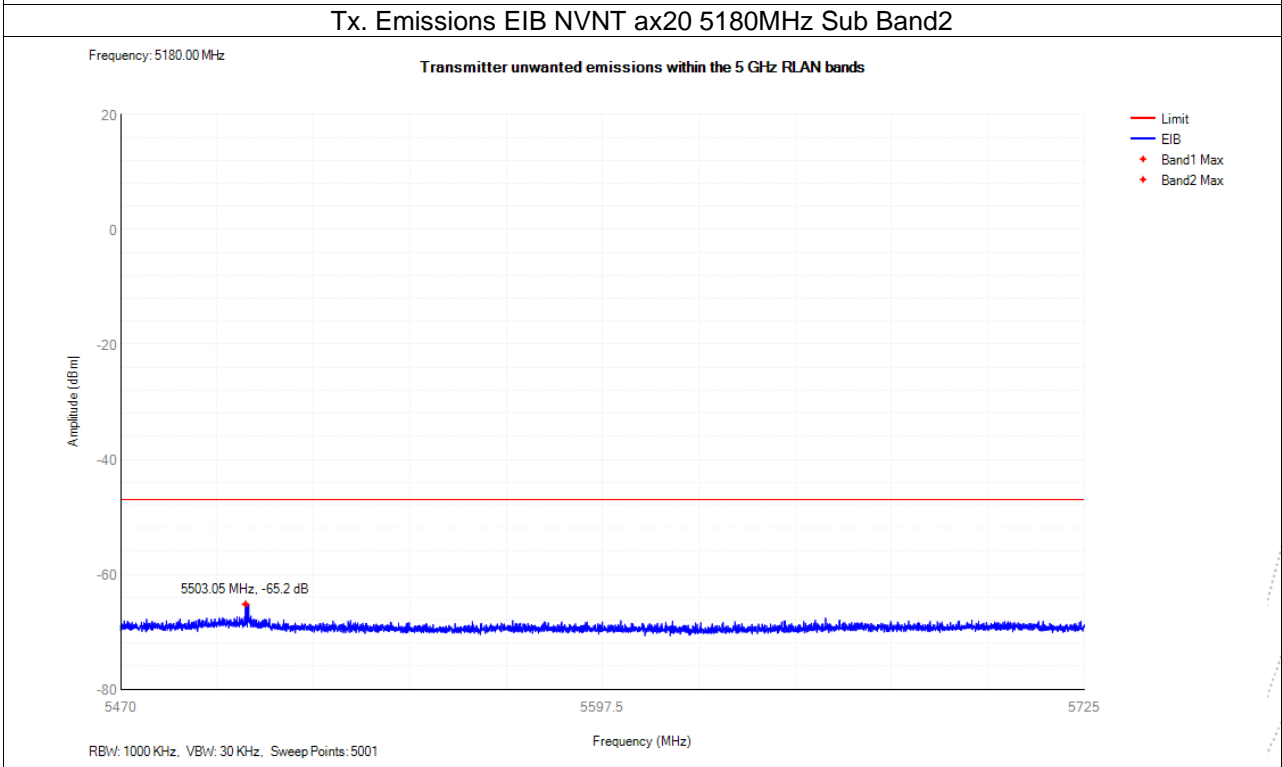
Tx. Emissions EIB NVNT ax20 5180MHz Sub Band1

Tx. Emissions EIB NVNT ax20 5180MHz Sub Band2

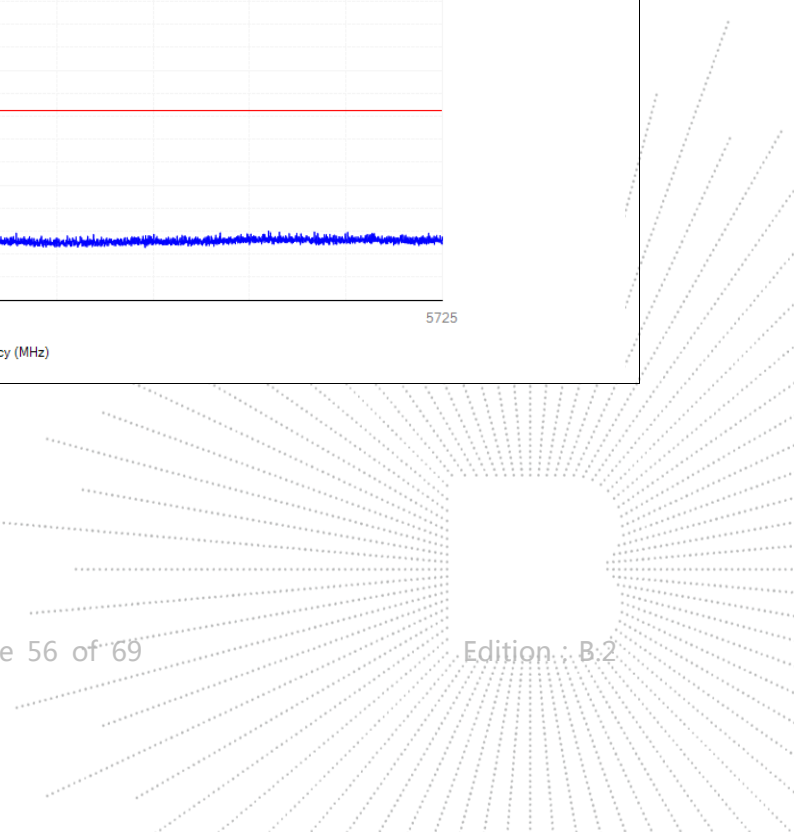
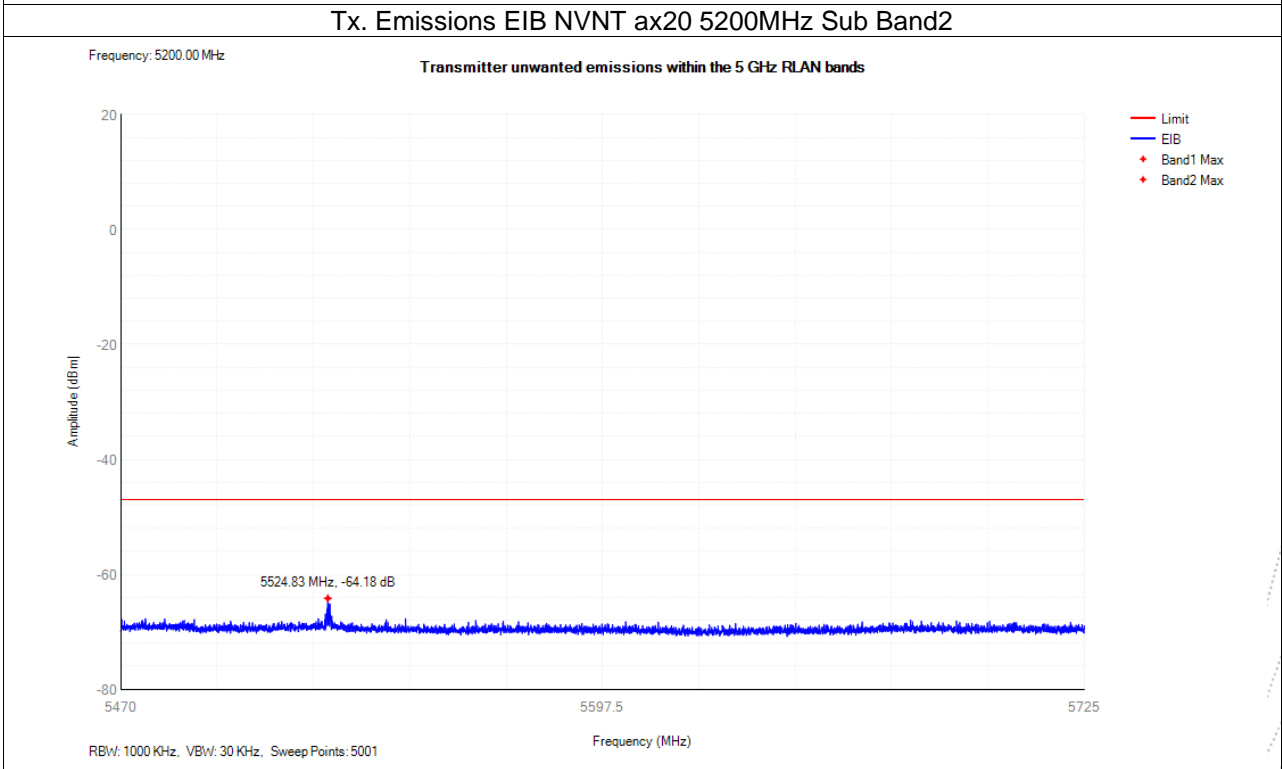
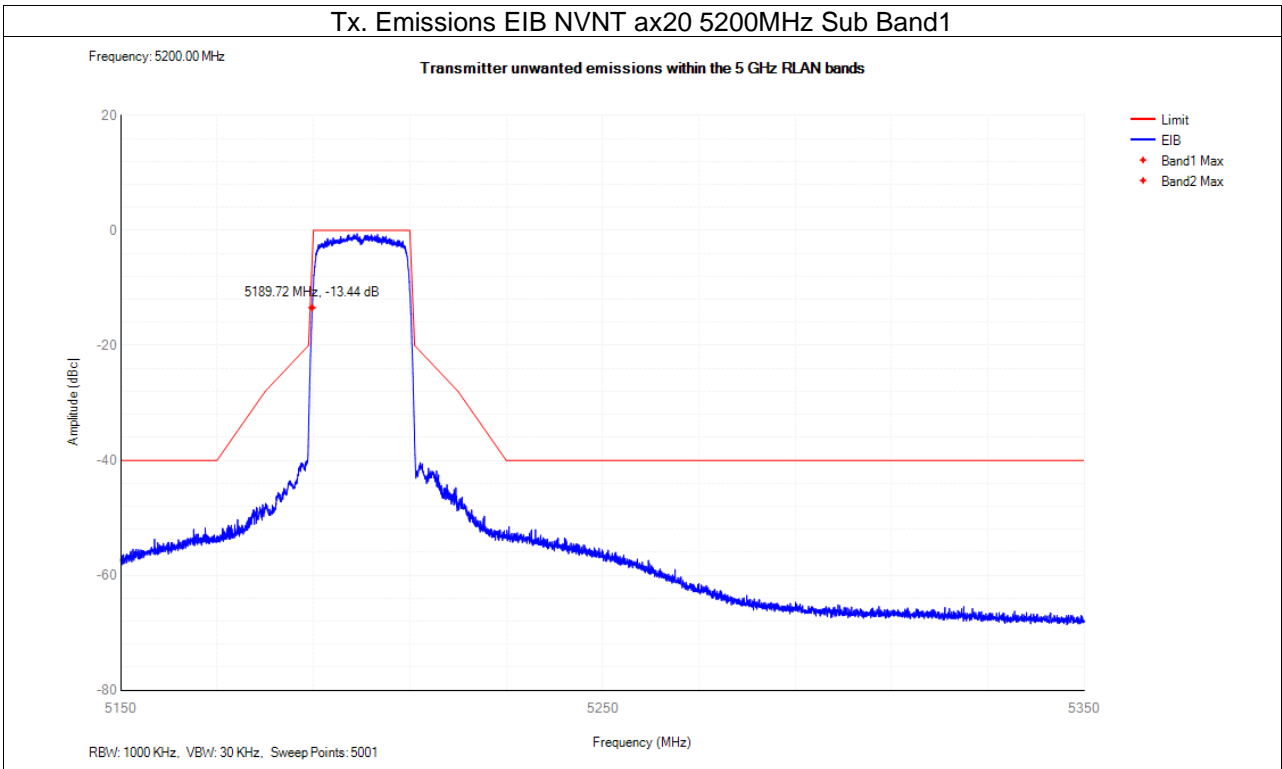
SHENZHEN

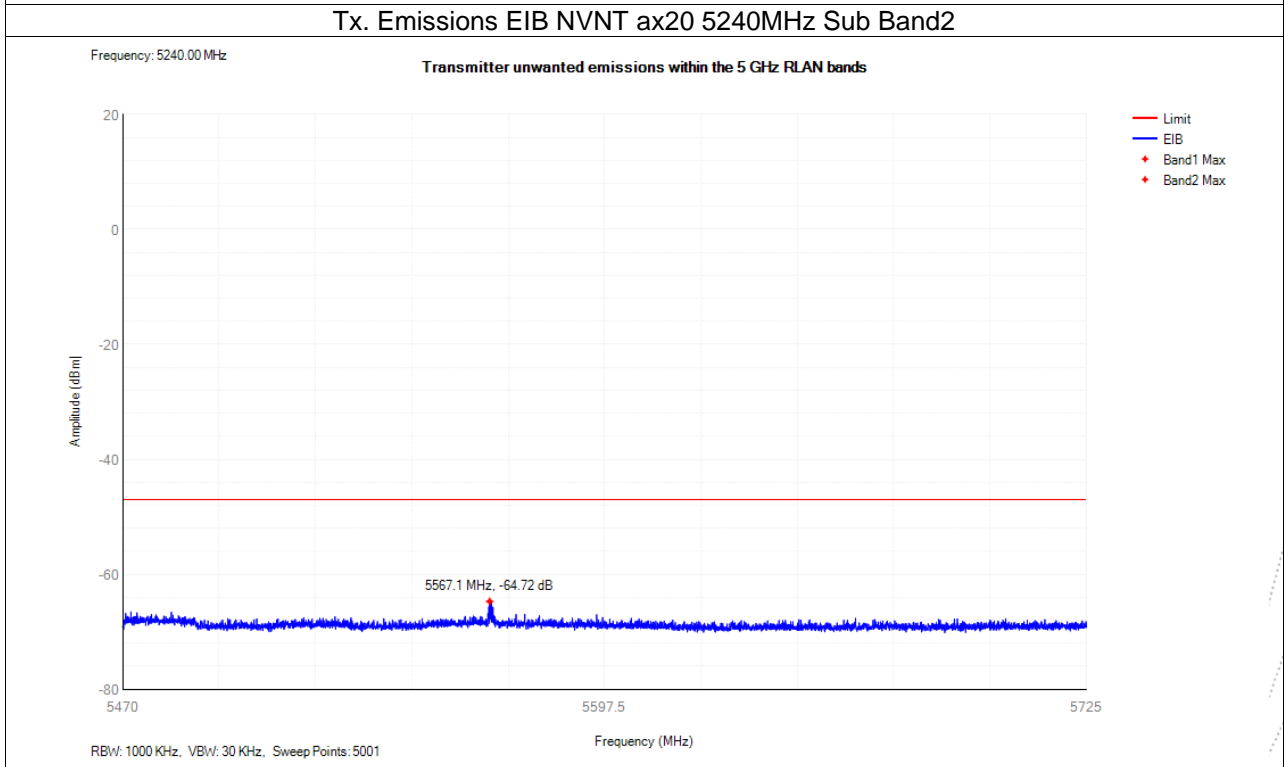
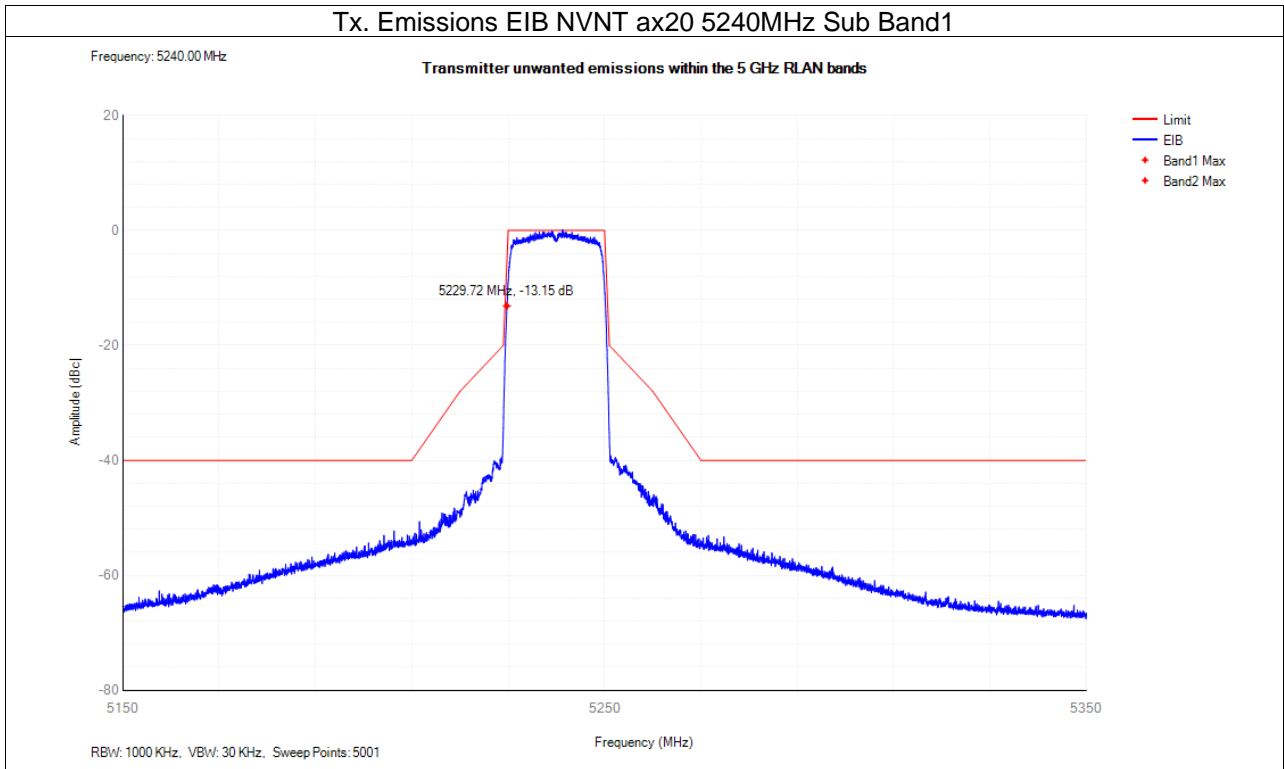

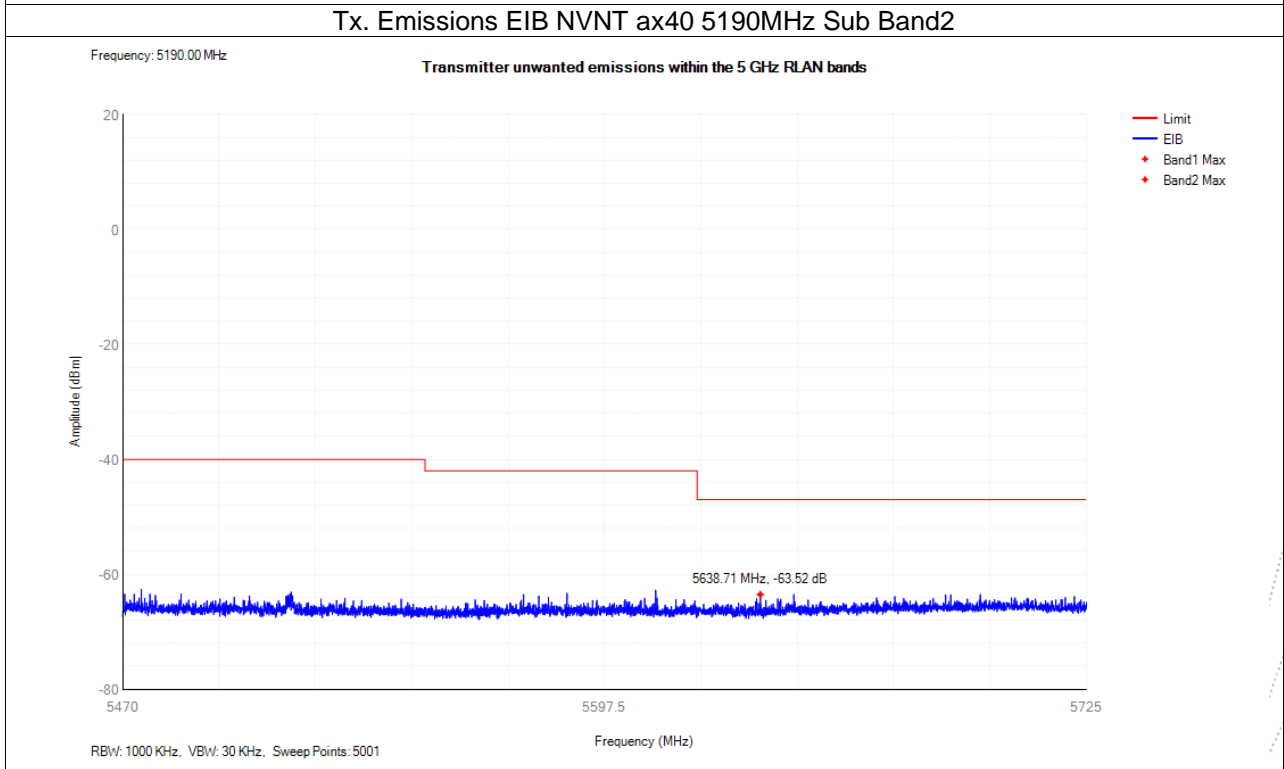
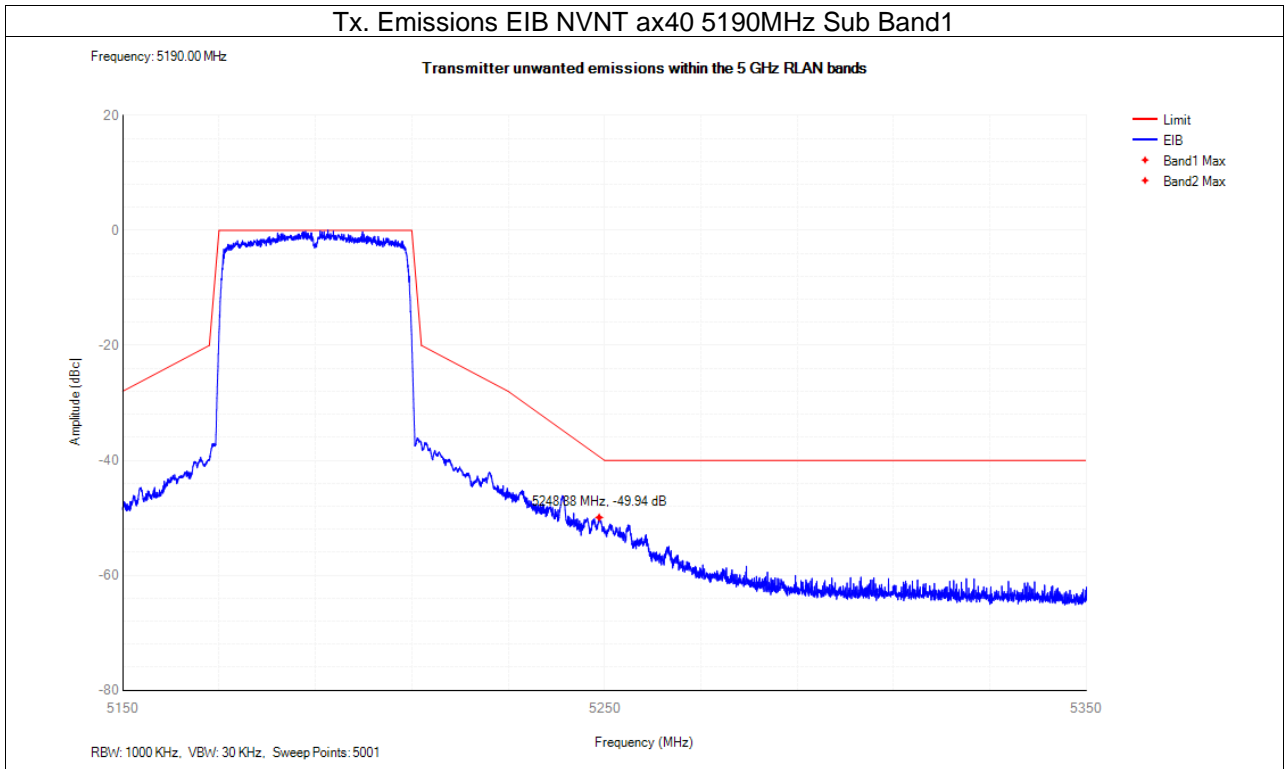

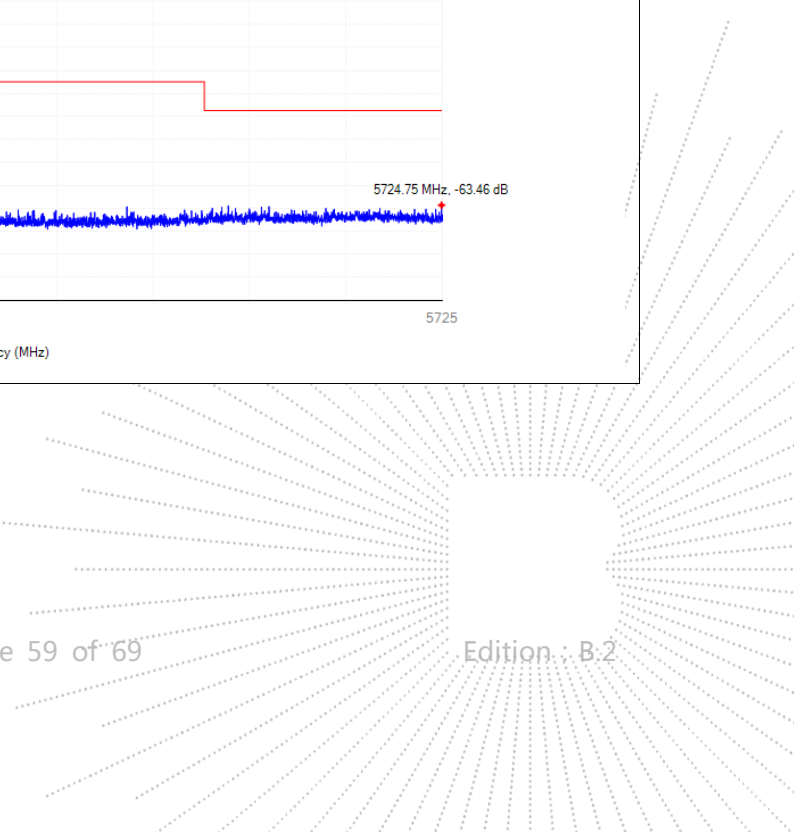
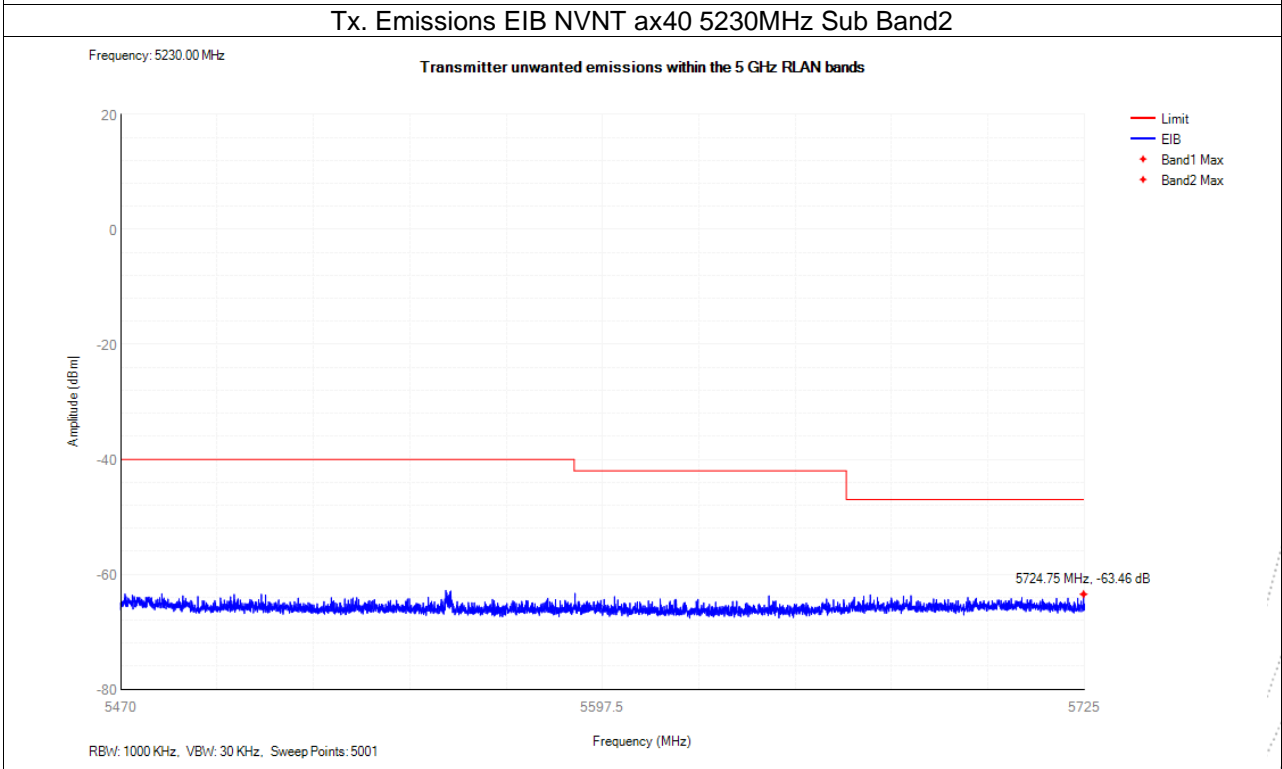
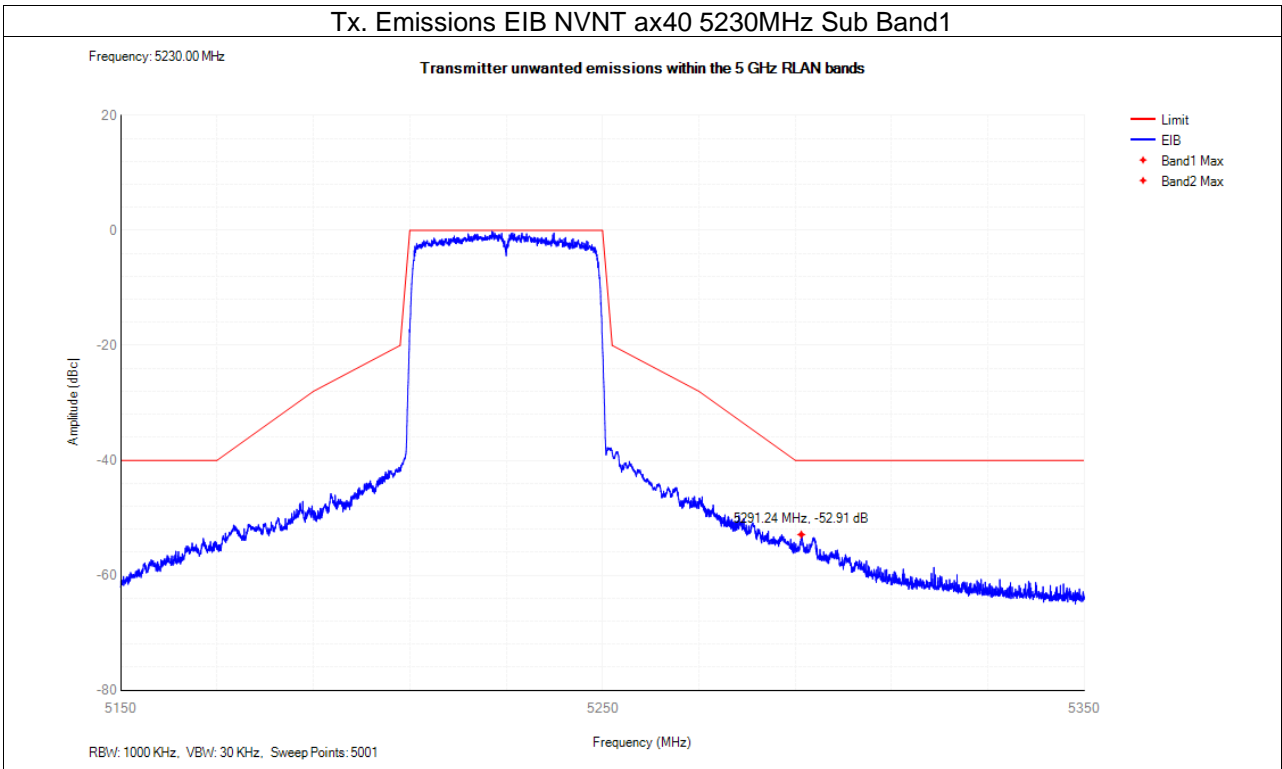

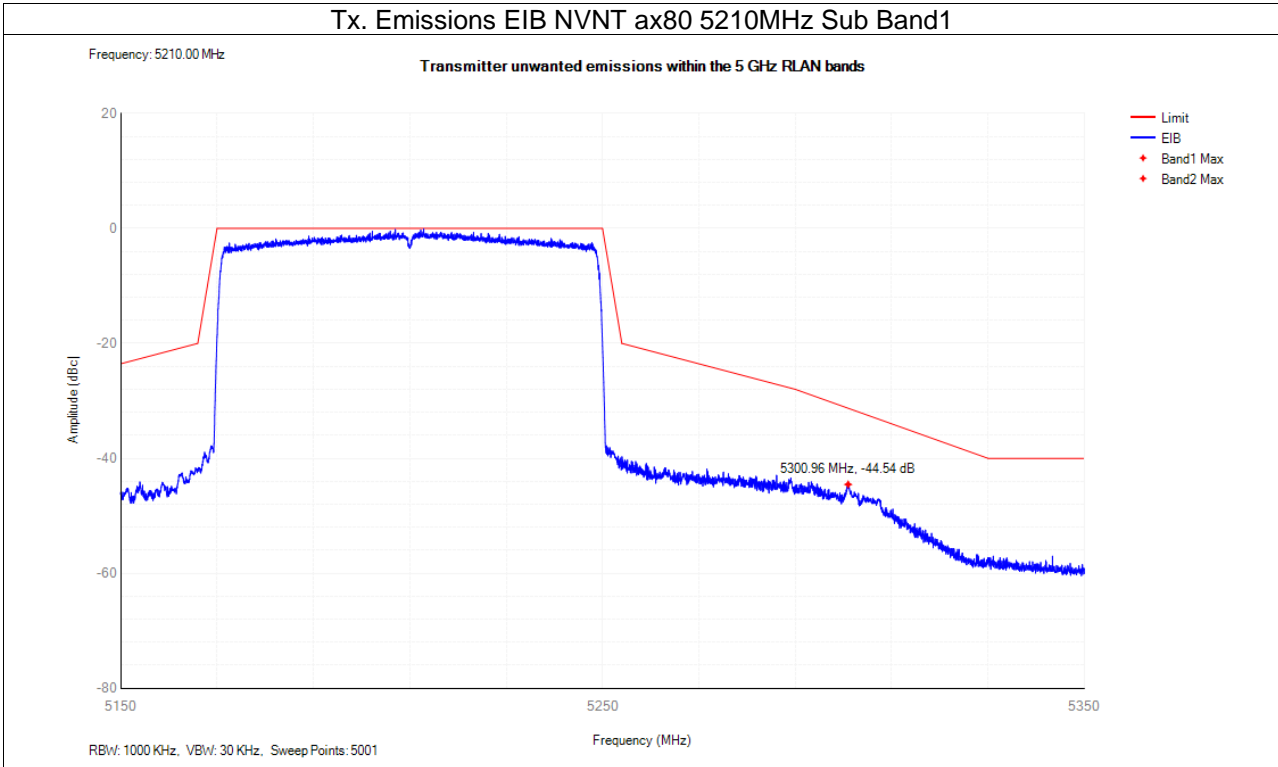
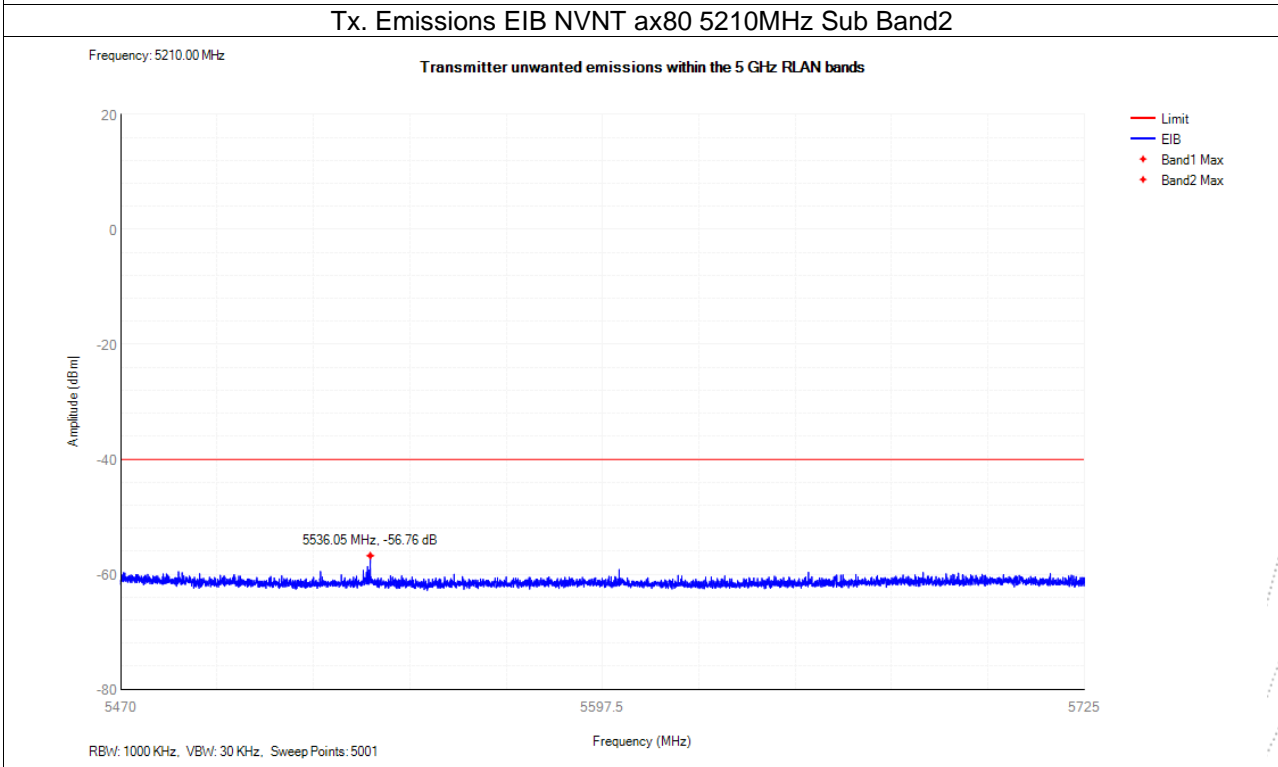

Tx. Emissions EIB NVNT ax80 5210MHz Sub Band1

Tx. Emissions EIB NVNT ax80 5210MHz Sub Band2

CO., LTD

13. Receiver Spurious Emissions

13.1 Block Diagram Of Test Setup

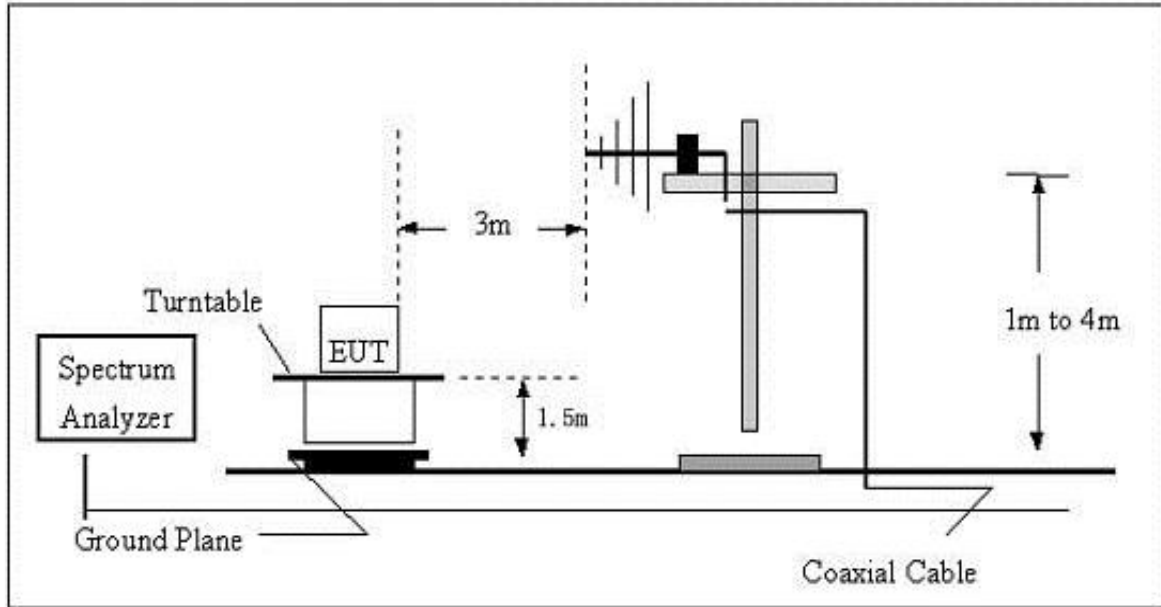
(A) Radiated Emission Test Set-Up Frequency Below 1GHz.



(B) Radiated Emission Test Set-Up Frequency Above 1GHz.

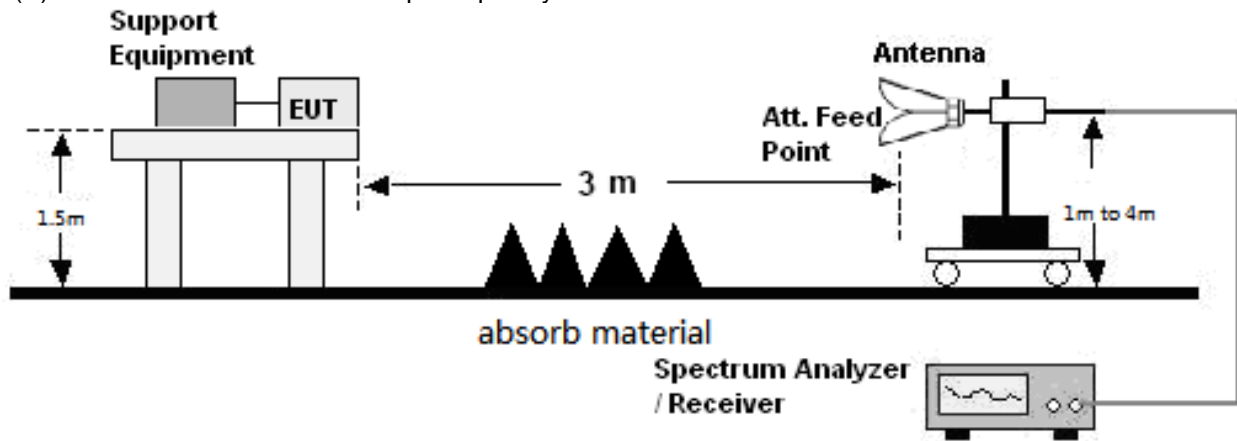

13.2 Limits

Frequency(MHz)	Limit
30-1000	-57dBm
1000-12750	-47dBm

13.3 Test Procedure

30MHz ~ 1GHz:

- a. The Product was placed on the nonconductive turntable 1.5m above the ground in a full anechoic chamber.
- b. Set the spectrum analyzer/receiver in Peak detector, Max Hold mode, and 120 kHz RBW. Record the maximum field strength of all the pre-scan process in the full band when the antenna is varied between 1~4 m in both horizontal and vertical, and the turntable is rotated from 0 to 360 degrees.
- c. For each frequency whose maximum record was higher or close to limit, measure its QP value: vary the antenna's height and rotate the turntable from 0 to 360 degrees to find the height and degree where Product radiated the maximum emission, then set the test frequency analyzer/receiver to QP Detector and specified bandwidth with Maximum Hold Mode, and record the maximum value.

Above 1GHz:

- a. The Product was placed on the non-conductive turntable 1.5 m above the ground in a full anechoic chamber.
- b. Set the spectrum analyzer/receiver in Peak detector, Max Hold mode, and 1MHz RBW. Record the maximum field strength of all the pre-scan process in the full band when the antenna is varied in both horizontal and vertical, and the turntable is rotated from 0 to 360 degrees.
- c. For each frequency whose maximum record was higher or close to limit, measure its AV value: rotate the turntable from 0 to 360 degrees to find the degree where Product radiated the maximum emission, then set the test frequency analyzer/receiver to AV value and specified bandwidth with Maximum Hold Mode, and record the maximum value.

13.4 Test Results

All modes have been tested and reports show data in the worst mode
 Test Mode: Transmitting 802.11n20 (worst case)

Frequency (MHz)	Receiver Reading (dBm)	Turn table Angle Degree	RX Antenna		Correct Factor (dBm)	Absolute Level (dBm)	Result	
			Height (m)	Polar (H/V)			Limit (dBm)	Margin (dB)
802.11n20 low channel								
262.70	-36.05	307	1.3	H	-29.33	-65.38	-57.00	-8.38
262.70	-37.21	216	1.1	V	-29.33	-66.54	-57.00	-9.54
3132.16	-38.56	144	1.9	H	-23.34	-61.89	-47.00	-14.89
3132.16	-36.10	182	1.8	V	-23.34	-59.44	-47.00	-12.44
802.11n20 Mid channel								
262.70	-36.69	99	1.6	H	-29.33	-66.02	-57.00	-9.02
262.70	-37.37	150	1.8	V	-29.33	-66.70	-57.00	-9.70
3132.16	-38.18	165	1.1	H	-23.34	-61.51	-47.00	-14.51
3132.16	-36.87	322	1.1	V	-23.34	-60.20	-47.00	-13.20
802.11n20 high channel								
262.70	-37.60	215	1.1	H	-29.33	-66.93	-57.00	-9.93
262.70	-38.15	175	1.2	V	-29.33	-67.48	-57.00	-10.48
3132.16	-38.55	322	1.6	H	-23.34	-61.89	-47.00	-14.89
3132.16	-35.51	267	1.1	V	-23.34	-58.84	-47.00	-11.84

14. Adaptivity

14.1 Block Diagram Of Test Setup

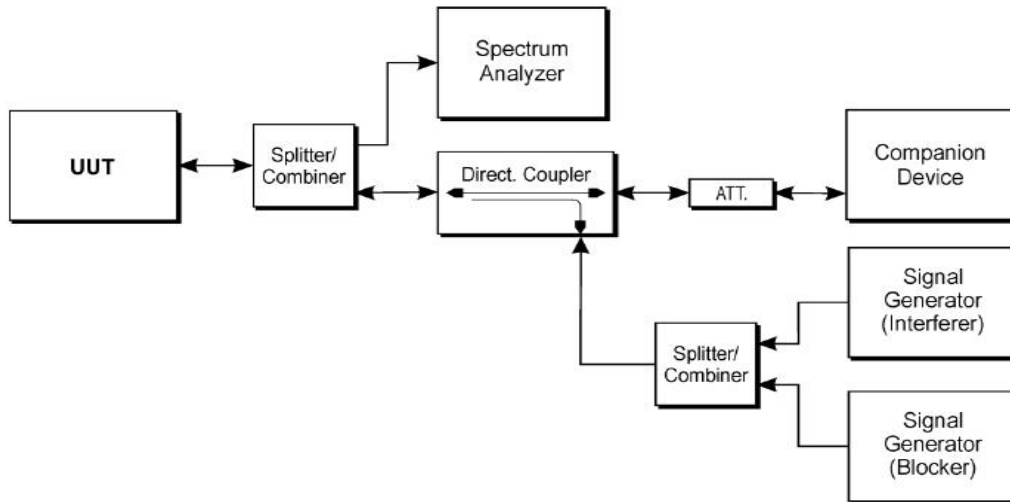

14.2 Limit

Requirement	Operational Mode		
	Frame Based Equipment	Load Based Equipment (CCA using 'energy detect')	Load Based Equipment (CCA not using any of the mechanisms referenced)
Minimum Clear Channel Assessment (CCA) Time	20 us (see note 1)	(see note 2)	20 us (see note 1)
Maximum Channel Occupancy (COT) Time	1ms to 10 ms	(see note 2)	(13/32)*q ms (see note 3)
Minimum Idle Period	5% of COT	(see note 2)	NA
Extended CCA check	NA	(see note 2)	N*CCA (see note 4)
Short Control Signalling Transmissions	Maximum duty cycle of 5% within an observation period of 50 ms (see note 5)		

Note 1: The CCA time used by the equipment shall be declared by the manufacturer.

Note 2: LBT based spectrum sharing mechanism based on the Clear Channel Assessment (CCA) mode using 'energy detect', as described in IEEE 802.11TM-2007[9], clauses 15 and 17, in IEEE 802.11nTM-2009[10], clauses 20.

Note 3: q is selected by the manufacturer in the range [4...32]

Note 4: The value of N shall be randomly selected in the range [1...q]

Note 5: Adaptive equipment may or may not have Short Control Signaling Transmissions.

14.3 Test Procedure

Step 1:

- The UUT shall connect to a companion device during the test. The signal generator, the spectrum analyzer, the UUT, the traffic source and the companion device are connected using a set-up equivalent to the example given by figure 14 although the interference source is switched off at this point in time. The spectrum analyzer is used to monitor the transmissions of the UUT in response to the interference signal. The traffic source might be part of the UUT itself.
- The received signal level (wanted signal from the companion device) at the UUT shall be sufficient to maintain a reliable link for the duration of the test. A typical value for the received signal level which can be used in most cases is -50 dBm/MHz.
- The analyzer shall be set as follows:
 - RBW: \geq Occupied Channel Bandwidth (if the analyzer does not support this setting, the highest available setting shall be used)
 - VBW: \geq RBW (if the analyzer does not support this setting, the highest available setting shall be used)
 - Detector Mode: RMS
 - Centre Frequency: Equal to the centre frequency of the operating channel
 - Span: 0 Hz
 - Sweep time: $> 2 \times$ Channel Occupancy Time
 - Trace Mode: Clear/Write
 - Trigger Mode: Video or RF/IF Power

Step 2:

- Configure the traffic source so that it fills the UUT's buffers to a level causing the UUT to always have transmissions queued (buffer-ready-for-transmission condition) towards the companion device. Where this is not possible, the UUT shall be configured to occupy the Channel Occupancy Time of the Fixed Frame Period to the highest extent possible.
- To avoid adverse effects on the measurement results, a unidirectional traffic source should be used. An example of such a unidirectional traffic source not triggering reverse traffic on higher layer protocols is UDP.

14.4 Test Result

PASS

15. Receiver Blocking

15.1 Block Diagram Of Test Setup

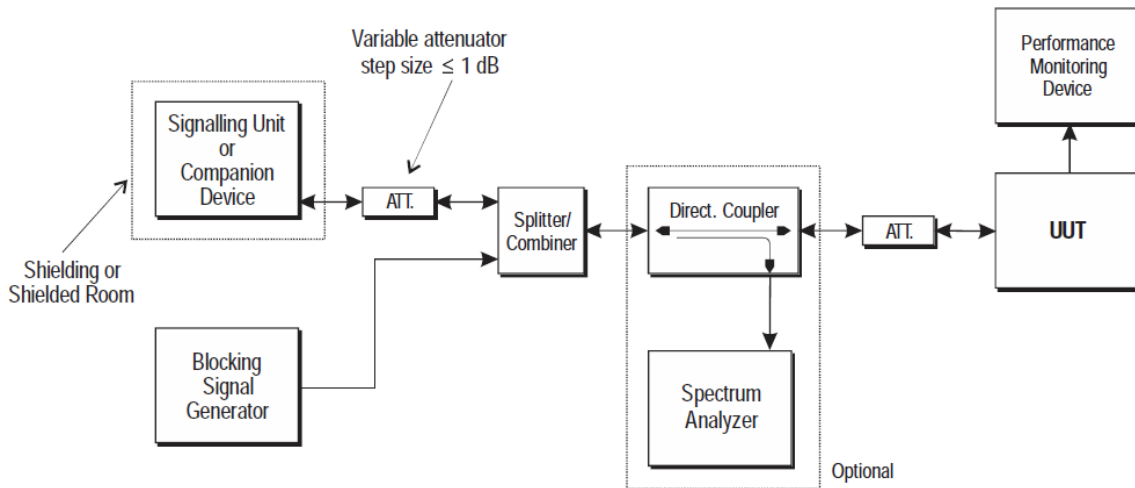

15.2 Limit

Wanted signal mean power from companion device (dBm)	Blocking signal frequency (MHz)	Blocking signal power (dBm) (see note 2)		Type of blocking signal
		Master or Slave with radar detection (see table D.2, note 2)	Slave without radar detection (see table D.2, note 2)	
$P_{min} + 6$ dB	5 100	-53	-59	Continuous Wave
$P_{min} + 6$ dB	4 900 5 000 5 975	-47	-53	Continuous Wave

NOTE 1: P_{min} is the minimum level of the wanted signal (in dBm) required to meet the minimum performance criteria as defined clause 4.2.8.3 in the absence of any blocking signal.

NOTE 2: The levels specified are levels in front of the UUT antenna. In case of conducted measurements, the same levels should be used at the antenna connector irrespective of antenna gain.

15.3 Test Procedure

Step 1:

- The UUT shall be set to the first operating frequency to be tested (see clause 5.3.2).

Step 2:

- The blocking signal generator is set to the first frequency as defined in table 9.

Step 3:

- With the blocking signal generator switched off a communication link is set up between the UUT and the associated companion device using the test setup shown in figure 18. The attenuation of the variable attenuator shall be increased in 1 dB steps to a value at which the minimum performance criteria as specified in clause 4.2.8.3 is still met. The resulting level for the wanted signal at the input of the UUT is P_{min} .
- This signal level (P_{min}) is increased by 6 dB resulting in a new level ($P_{min} + 6$ dB) of the wanted signal at the UUT receiver input.

Step 4:

- The level of the blocking signal at the UUT input is set to the level provided in table 9. It shall be verified and recorded in the test report that the performance criteria as specified in clause 4.2.8.3 are met.
- If the performance criteria as specified in clause 4.2.8.3 are met, the level of the blocking signal at the UUT may be further increased (e.g. in steps of 1 dB) until the level whereby the performance criteria as specified in clause 4.2.8.3 are no longer met. The highest level at which the performance criteria are met is recorded in the test report.

Step 5:

- Repeat step 4 for each remaining combination of frequency and level as specified in table 9.

Step 6:

- Repeat step 2 to step 5 with the UUT operating at the other operating frequencies at which the blocking test has to be performed. See clause 5.3.2.

15.4 Test Result

All modes have been tested and reports show data in the worst mode
The worst mode(802.11a)

Transmitting	$P_{min}(dBm)$	Blocking Frequency (MHz)	Blocking Power(dBm)	Measured PER(%)	Limit (%)
5180	-74	5100	-59	9.16	10
5180	-74	4900	-53	8.15	10
5180	-74	5000	-53	9.64	10
5180	-74	5975	-53	1.08	10
5700	-73	5100	-59	8.52	10
5700	-73	4900	-53	4.83	10
5700	-73	5000	-53	6.78	10
5700	-73	5975	-53	5.25	10

16. EUT Photographs

EUT Photo 1

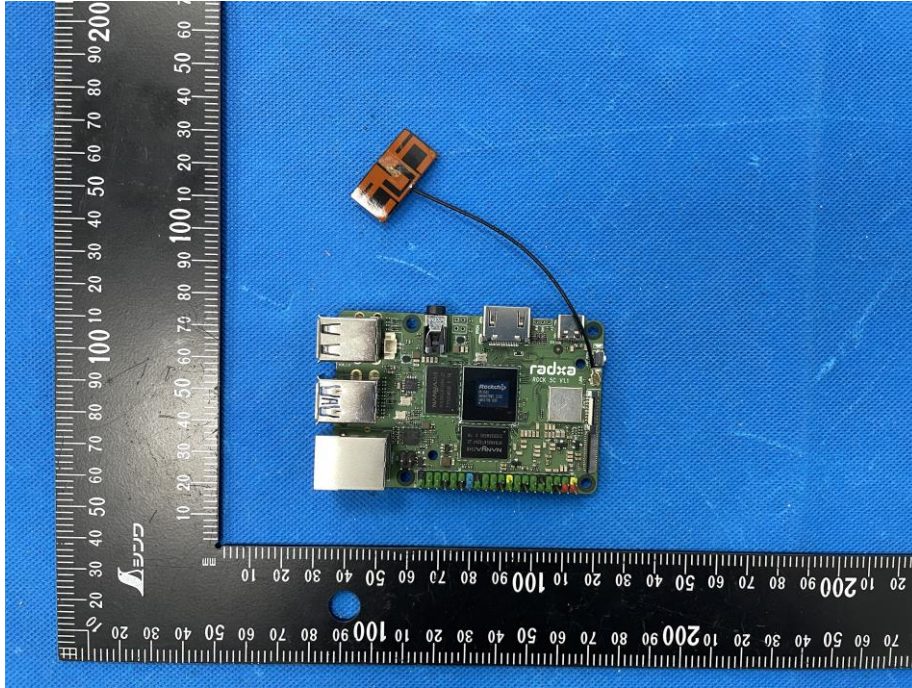

EUT Photo 2

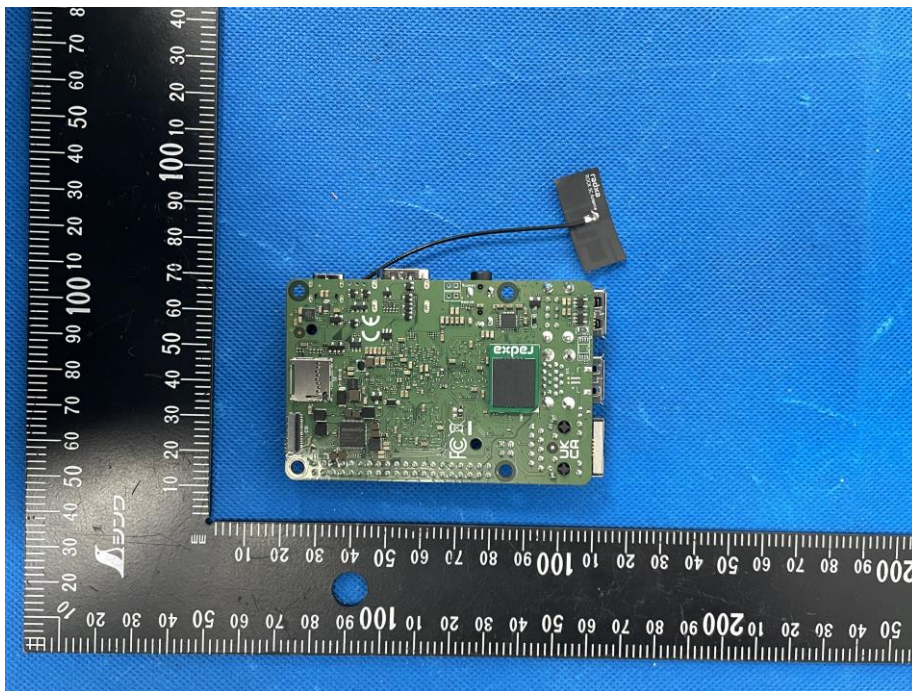

NOTE: Appendix-Photographs Of EUT Constructional Details

17. EUT Test Setup Photographs

Spurious emissions



STATEMENT

1. The equipment lists are traceable to the national reference standards.
2. The test report can not be partially copied unless prior written approval is issued from our lab.
3. The test report is invalid without the "special seal for inspection and testing".
4. The test report is invalid without the signature of the approver.
5. The test process and test result is only related to the Unit Under Test.
6. Sample information is provided by the client and the laboratory is not responsible for its authenticity.
7. The quality system of our laboratory is in accordance with ISO/IEC17025.
8. If there is any objection to this test report, the client should inform issuing laboratory within 15 days from the date of receiving test report.

Address:

1-2/F., Building B, Pengzhou Industrial Park, No.158, Fuyuan 1st Road, Zhancheng, Fuhai Subdistrict, Bao'an District, Shenzhen, Guangdong, China

TEL: 400-788-9558

P.C.: 518103

FAX: 0755-33229357

Website: <http://www.chnbctc.com>Consultation E-mail: bctc@bctc-lab.com.cnComplaint/Advice E-mail: advice@bctc-lab.com.cn

***** END *****