

TEST REPORT

Report No.: BCTC2210671499-3E

Applicant: OKdo Technology Limited

Product Name: ROCK Pi 4/ROCK 4

Model/Type Ref.: ROCK 4C Plus

Tested Date: 2022-10-19 to 2022-12-06

Issued Date: 2022-12-06

Shenzhen BCTC Testing Co., Ltd.



IC: 29530-ROCK4CPLUS

Product Name: ROCK Pi 4/ROCK 4
Trademark: N/A
Model/Type Ref.: ROCK 4C Plus
Prepared For: OKdo Technology Limited
Address: 5th Floor, 2 Pancras Square, King's Cross, London N1C 4AG, United Kingdom
Manufacturer: OKdo Technology Limited
Address: 5th Floor, 2 Pancras Square, King's Cross, London N1C 4AG, United Kingdom
Prepared By: Shenzhen BCTC Testing Co., Ltd.
Address: 1-2/F., Building B, Pengzhou Industrial Park, No.158, Fuyuan 1st Road, Zhancheng, Fuhai Subdistrict, Bao'an District, Shenzhen, Guangdong, China
Sample Received Date: 2022-10-19
Sample Tested Date: 2022-10-19 to 2022-12-06
Issue Date: 2022-12-06
Report No.: BCTC2210671499-3E
Test Standards: Rss-247 Issue 2: February 2017
RSS-Gen Issue 5: Amendment 2 (February 2021)
Ansi C63.10:2013
Test Results: Pass
Remark: This Is WIFI-2.4G Radio Test Report.

Tested by:

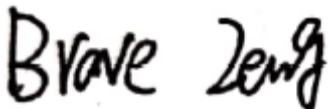

Brave Zeng/ Project Handler

Approved by:



Zero Zhou/Reviewer

The test report is effective only with both signature and specialized stamp. This result(s) shown in this report refer only to the sample(s) tested. Without written approval of Shenzhen BCTC Testing Co., Ltd, this report can't be reproduced except in full. The tested sample(s) and the sample information are provided by the client.

Table Of Content

	Page
Test Report Declaration	
1. Version	5
2. Test Summary	6
3. Measurement Uncertainty	7
4. Product Information And Test Setup	8
4.1 Product Information.....	8
4.2 Test Setup Configuration	8
4.3 Support Equipment	9
4.4 Channel List.....	9
4.5 Test Mode	9
4.6 Table Of Parameters Of Text Software Setting.....	11
5. Test Facility And Test Instrument Used.....	12
5.1 Test Facility.....	12
5.2 Test Instrument Used.....	12
6. Conducted Emissions.....	14
6.1 Block Diagram Of Test Setup.....	14
6.2 Limit	14
6.3 Test Procedure	14
6.4 EUT Operating Conditions	14
6.5 Test Result.....	15
7. Radiated Emissions.....	17
7.1 Block Diagram Of Test Setup.....	17
7.2 Limit	18
7.3 Test Procedure	19
7.4 EUT Operating Conditions	20
7.5 Test Result.....	20
8. Radiated Band Emission Measurement And Restricted Bands Of Operation	26
8.1 Block Diagram Of Test Setup.....	26
8.2 Limit	26
8.3 Test Procedure	27
8.4 EUT Operating Conditions	27
8.5 Test Result.....	28
9. Power Spectral Density Test	30
9.1 Block Diagram Of Test Setup.....	30
9.2 Limit	30
9.3 Test Procedure	30
9.4 EUT Operating Conditions	30
9.5 Test Result.....	31
10. 99% & 6dB Bandwidth Test.....	37
10.1 Block Diagram Of Test Setup.....	37
10.2 Limit	37
10.3 Test Procedure	37
10.4 EUT Operating Conditions	37
10.5 Test Result.....	38

11. Peak Output Power Test	49
11.1 Block Diagram Of Test Setup.....	49
11.2 Limit	49
11.3 Test Procedure	49
11.4 EUT Operating Conditions	49
11.5 Test Result.....	50
12. 100 KHz Bandwidth Of Frequency Band Edge.....	51
12.1 Block Diagram Of Test Setup.....	51
12.2 Limit	51
12.3 Test Procedure	51
12.4 EUT Operating Conditions	51
12.5 Test Result.....	52
13. Duty Cycle Of Test Signal	67
13.1 Standard Requirement.....	67
13.2 Formula:.....	67
14. Antenna Requirement	73
14.1 Limit	73
14.2 Test Result.....	73
15. EUT Photographs.....	74
16. EUT Test Setup Photographs.....	75

(Note: N/A Means Not Applicable)

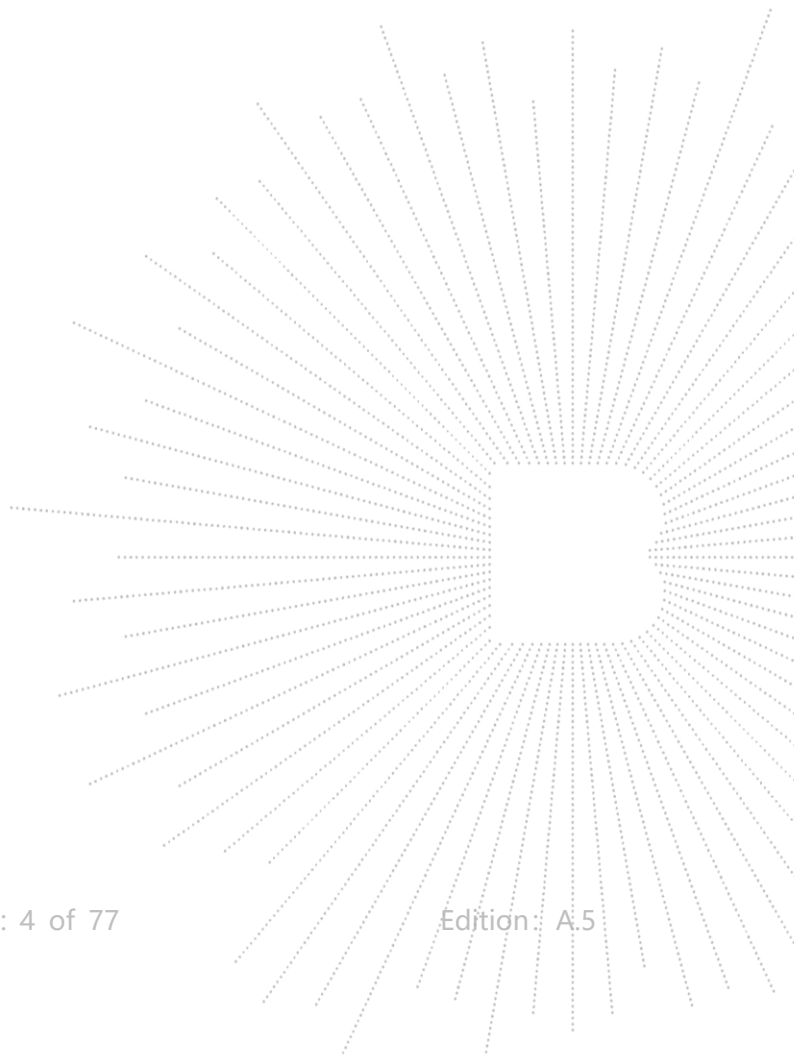

1. Version

Report No.	Issue Date	Description	Approved
BCTC2210671499-3E	2022-12-06	Original	Valid

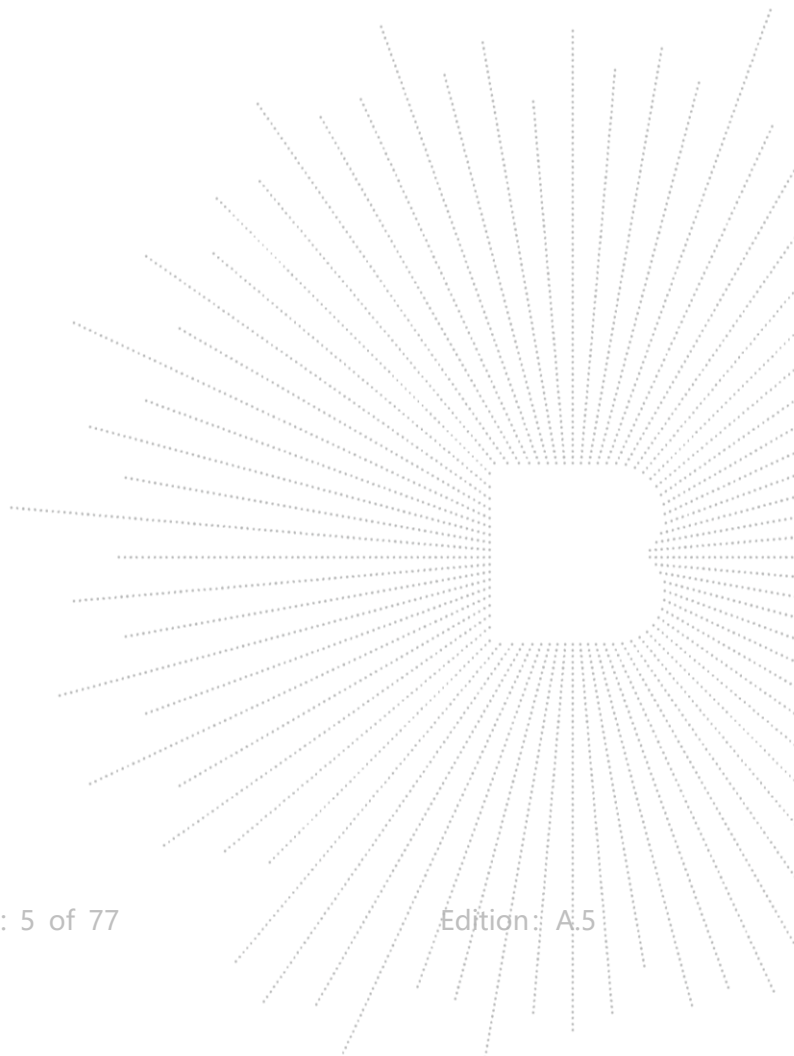

2. Test Summary

Test procedures according to the technical standards:

RSS-247 Issue 2: February 2017			
Standard Section	Test Item	Judgment	Remark
RSS-GEN 8.8 RSS-247 3.1	Conducted Emission	PASS	N/A
RSS-247 5.2 (a)	6dB Bandwidth	PASS	N/A
RSS-Gen.6.7	99% Bandwidth	PASS	N/A
RSS-247 5.4 (d)	Peak Output Power	PASS	N/A
RSS-247 5.5	Radiated Spurious Emission	PASS	N/A
RSS-247 5.2 (b)	Power Spectral Density	PASS	N/A
RSS-247 5.5	Restricted Band of Operation	PASS	N/A
RSS-247 5.5	Band Edge (Out of Band Emissions)	PASS	N/A
RSS-Gen.6.8	Antenna Requirement	PASS	N/A

NOTE:

(1) "N/A" denotes test is not applicable in this Test Report

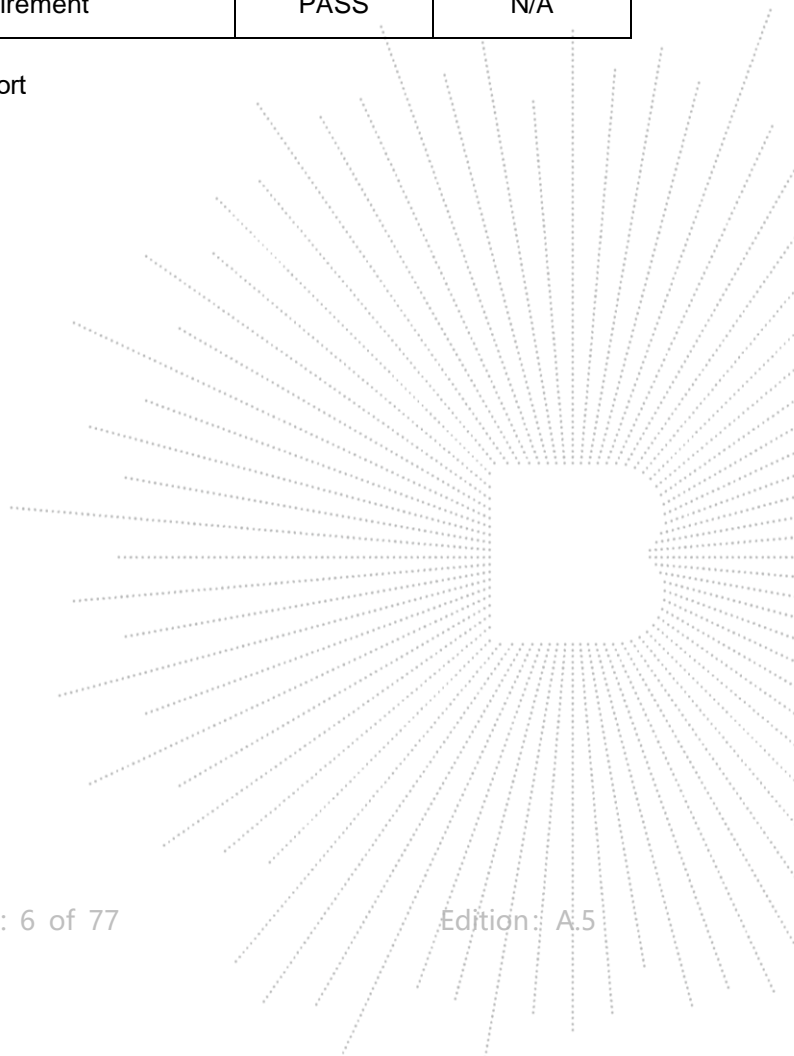

3. Measurement Uncertainty

The reported uncertainty of measurement $y \pm U$, where expanded uncertainty U is based on a standard uncertainty multiplied by a coverage factor of $k=2$, providing a level of confidence of approximately 95 %.

No.	Item	Uncertainty
1	3m chamber Radiated spurious emission(30MHz-1GHz)	U=4.3dB
2	3m chamber Radiated spurious emission(1GHz-18GHz)	U=4.5dB
3	3m chamber Radiated spurious emission(18GHz-40GHz)	U=3.34dB
4	Conducted Adjacent channel power	U=1.38dB
5	Conducted output power uncertainty Above 1G	U=1.576dB
6	Conducted output power uncertainty below 1G	U=1.28dB
7	humidity uncertainty	U=5.3%
8	Temperature uncertainty	U=0.59°C

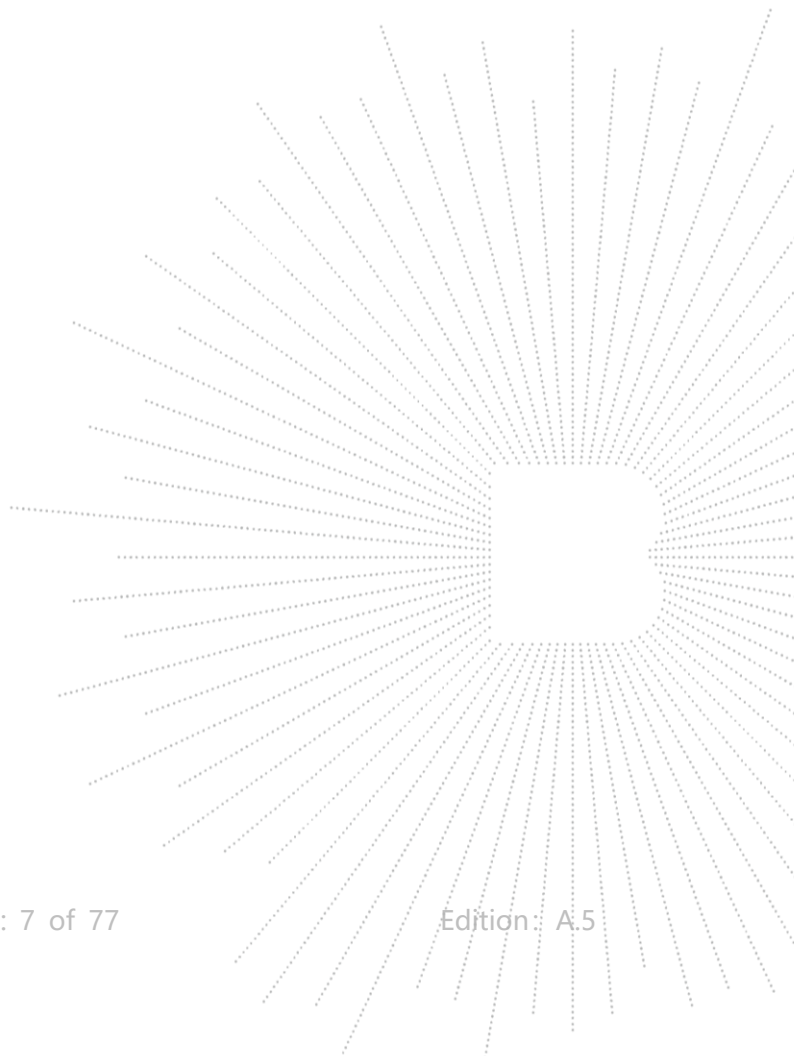

4. Product Information And Test Setup

4.1 Product Information

Model/Type Ref.:	ROCK 4C Plus
Model differences:	N/A
Hardware Version:	V1.0
Software Version:	V1.0
Operation Frequency:	802.11b/g/n20MHz:2412~2462 MHz
Bit Rate of Transmitter	802.11b:11/5.5/2/1 Mbps
	802.11g:54/48/36/24/18/12/9/6Mbps
	802.11n Up to 75Mbps
Type of Modulation:	OFDM/DSSS
Number Of Channel	802.11b/g/n20MHz:11 CH
Antenna installation:	FPC antenna
Antenna Gain:	-7.23 dBi
Ratings:	DC 5V from adapter

4.2 Test Setup Configuration

See test photographs attached in *EUT TEST SETUP PHOTOGRAPHS* for the actual connections between Product and support equipment.

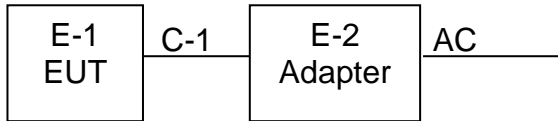

Radiated Spurious Emission

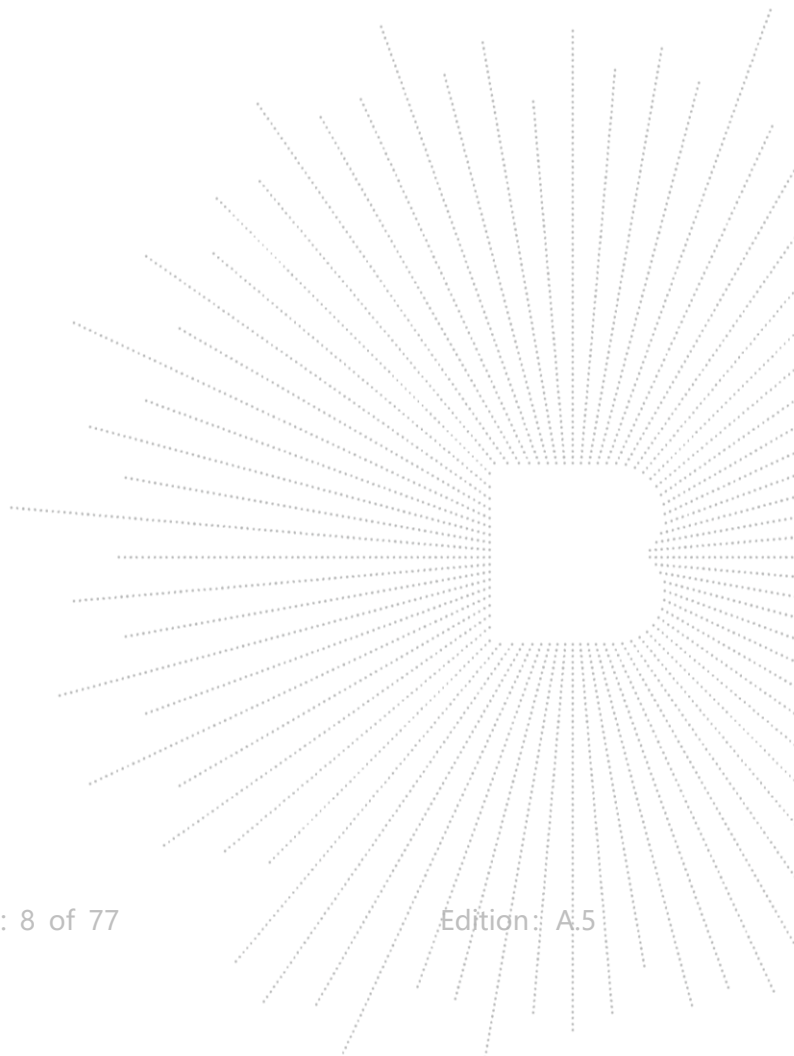
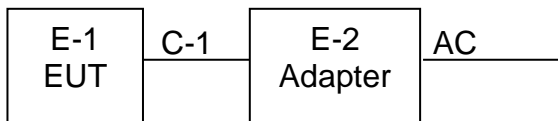

4.3 Support Equipment

No.	Device Type	Brand	Model	Series No.	Note
E-1	ROCK Pi 4/ROCK 4	N/A	ROCK 4C Plus	N/A	EUT
E-2	Adapter	N/A	BCTC001	N/A	Auxiliary
E-3	Mouse	N/A	N/A	N/A	Auxiliary
E-4	Keyboard	N/A	N/A	N/A	Auxiliary
E-5	earphone	N/A	N/A	N/A	Auxiliary
E-6	Router	N/A	N/A	N/A	Auxiliary

Item	Shielded Type	Ferrite Core	Length	Note
C-1	N/A	N/A	1M	DC cable unshielded

Notes:

- All the equipment/cables were placed in the worst-case configuration to maximize the emission during the test.
- Grounding was established in accordance with the manufacturer's requirements and conditions for the intended use.

4.4 Channel List

Channel List for 802.11b/g/n(20)					
Channel	Frequency (MHz)	Channel	Frequency (MHz)	Channel	Frequency (MHz)
01	2412	02	2417	03	2422
04	2427	05	2432	06	2437
07	2442	08	2447	09	2452
10	2457	11	2462	12	2467
13	2472				

4.5 Test Mode

To investigate the maximum EMI emission characteristics generated from EUT, the test system was pre-scanning tested based on the consideration of following EUT operation mode or test configuration mode which possibly have effect on EMI emission level. Each of these EUT operation mode(s) or test configuration mode(s) mentioned above was evaluated respectively.

For All Mode	Description	Modulation Type
Mode 1	CH 01	802.11b
Mode 2	CH 06	
Mode 3	CH 11	
Mode 4	CH 01	802.11g
Mode 5	CH 06	
Mode 6	CH 11	
Mode 7	CH 01	802.11n20
Mode 8	CH 06	
Mode 9	CH 11	
Mode 10	Link mode (Conducted emission and Radiated emission)	

Notes:

- The measurements are performed at the highest, middle, lowest available channels.

2. The measurements are performed at all Bit Rate of Transmitter, the worst data was reported
3. According to ANSI C63.10 standards, the test results are both the “worst case” and “worst setup”
11Mbps for 802.11b, 6Mbps for 802.11g, 13Mbps for 802.11n(H20), 54Mbps for 802.11n(H40),

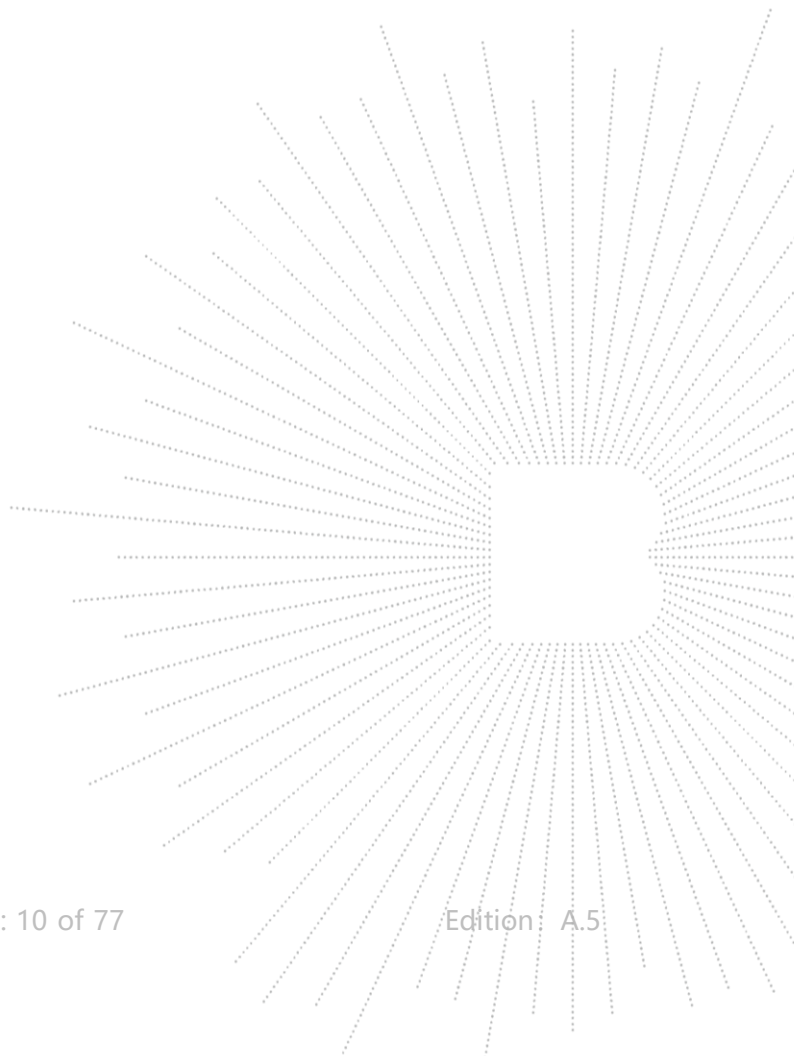

4.6 Table Of Parameters Of Text Software Setting

During testing channel & power controlling software provided by the customer was used to control the operating channel as well as the output power level. The RF output power selection is for the setting of RF output power expected by the customer and is going to be fixed on the firmware of the final end product power parameters

Test software Version	CMD		
Frequency	2412 MHz	2437 MHz	2462 MHz
Parameters	DEF	DEF	DEF

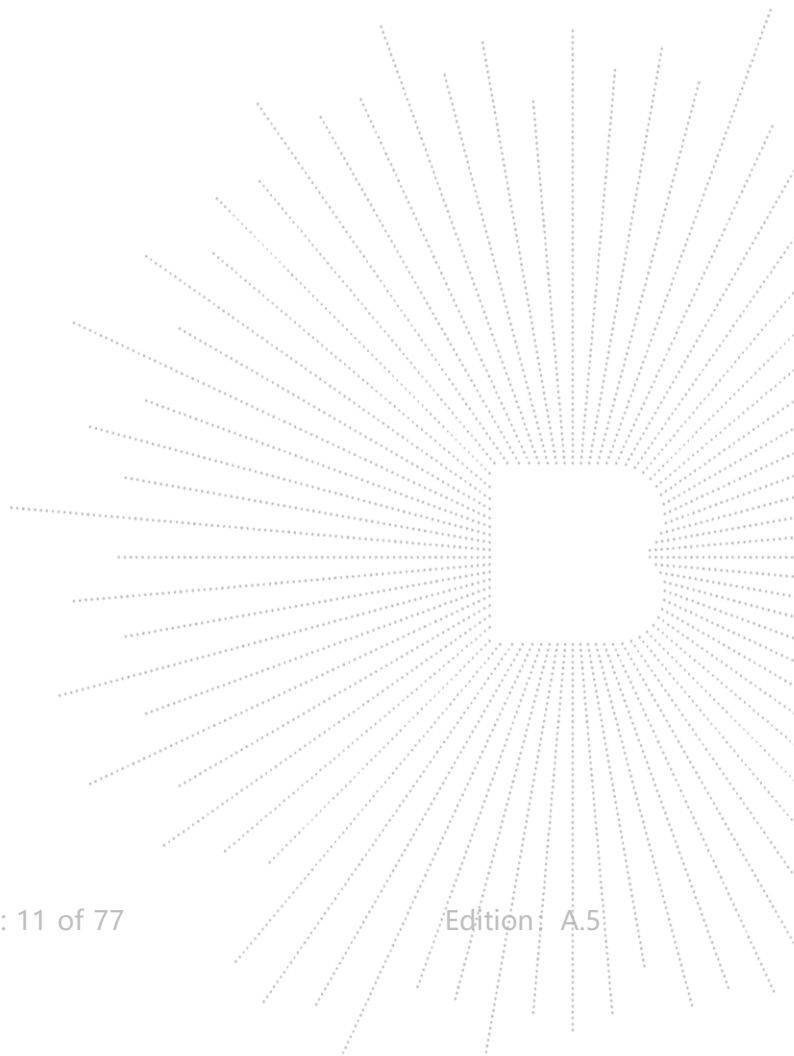

5. Test Facility And Test Instrument Used

5.1 Test Facility

All measurement facilities used to collect the measurement data are located at Shenzhen BCTC Testing Co., Ltd. Address:1-2/F., Building B, Pengzhou Industrial Park, No.158, Fuyuan 1st Road, Zhancheng, Fuhai Subdistrict, Bao'an District, Shenzhen, Guangdong, China. The site and apparatus are constructed in conformance with the requirements of ANSI C63.4 and CISPR 16-1-1 other equivalent standards. FCC Test Firm Registration Number: 712850
IC Registered No.: 23583

5.2 Test Instrument Used

Conducted emissions Test					
Equipment	Manufacturer	Model#	Serial#	Last Cal.	Next Cal.
Receiver	R&S	ESR3	102075	May 24, 2022	May 23, 2023
LISN	R&S	ENV216	101375	May 24, 2022	May 23, 2023
Software	Frad	EZ-EMC	EMC-CON 3A1	\	\
Attenuator	\	10dB DC-6GHz	1650	May 24, 2022	May 23, 2023

RF Conducted Test					
Equipment	Manufacturer	Model#	Serial#	Last Cal.	Next Cal.
Power Metter	Keysight	E4419	\	May 24, 2022	May 23, 2023
Power Sensor (AV)	Keysight	E9300A	\	May 24, 2022	May 23, 2023
Signal Analyzer20kHz- 26.5GHz	Keysight	N9020A	MY49100060	May 24, 2022	May 23, 2023
Spectrum Analyzer9kHz- 40GHz	R&S	FSP40	\	May 24, 2022	May 23, 2023

Radiated Emissions Test (966 Chamber01)					
Equipment	Manufacturer	Model#	Serial#	Last Cal.	Next Cal.
966 chamber	ChengYu	966 Room	966	Jun. 06. 2020	Jun. 05, 2023
Receiver	R&S	ESR3	102075	May 24, 2022	May 23, 2023
Receiver	R&S	ESRP	101154	May 24, 2022	May 23, 2023
Amplifier	SKET	LAPA_01G18 G-45dB	\	May 24, 2022	May 23, 2023
Amplifier	Schwarzbeck	BBV9744	9744-0037	May 24, 2022	May 23, 2023
TRILOG Broadband Antenna	Schwarzbeck	VULB9163	942	May 26, 2022	May 25, 2023
Horn Antenna	Schwarzbeck	BBHA9120D	1541	Jun. 06, 2022	Jun. 05, 2023
Horn Antenna(18G Hz-40GHz)	Schwarzbeck	BBHA9170	00822	Jun. 06, 2022	Jun. 05, 2023
Amplifier(18G Hz-40GHz)	MITEQ	TTA1840-35- HG	2034381	May 26, 2022	May 25, 2023
Loop Antenna(9KHz -30MHz)	Schwarzbeck	FMZB1519B	00014	May 26, 2022	May 25, 2023
Power Metter	Keysight	E4419	\	May 26, 2022	May 25, 2023
Power Sensor (AV)	Keysight	E9300A	\	May 26, 2022	May 25, 2023
Signal Analyzer20kH z-26.5GHz	Keysight	N9020A	MY49100060	May 26, 2022	May 25, 2023
Spectrum Analyzer9kHz- 40GHz	R&S	FSP40	\	May 26, 2022	May 25, 2023
Software	Frad	EZ-EMC	FA-03A2 RE	\	\

6. Conducted Emissions

6.1 Block Diagram Of Test Setup

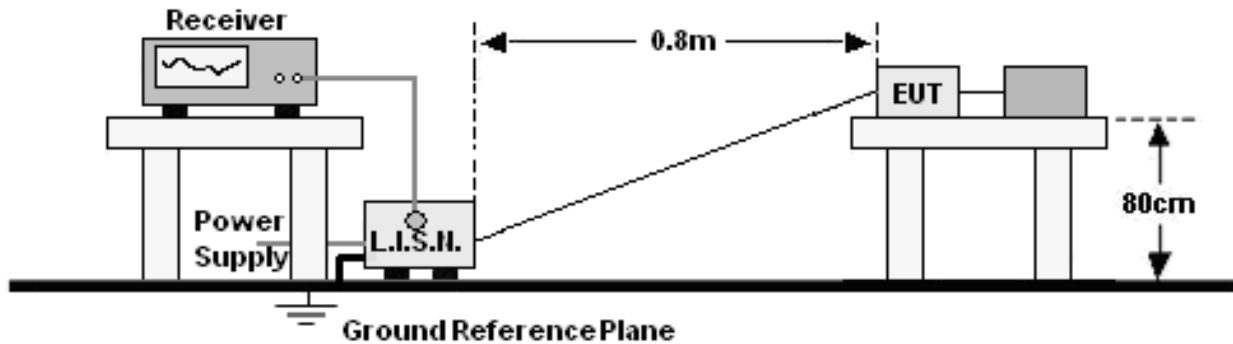

6.2 Limit

FREQUENCY (MHz)	Limit (dBuV)	
	Quas-peak	Average
0.15 -0.5	66 - 56 *	56 - 46 *
0.50 -5.0	56.00	46.00
5.0 -30.0	60.00	50.00

Notes:
 1. *Decreasing linearly with logarithm of frequency.
 2. The lower limit shall apply at the transition frequencies.

6.3 Test Procedure

Receiver Parameters	Setting
Attenuation	10 dB
Start Frequency	0.15 MHz
Stop Frequency	30 MHz
IF Bandwidth	9 kHz

- The Product was placed on a nonconductive table 0.8 m above the horizontal ground reference plane, and 0.4 m from the vertical ground reference plane, and connected to the main through Line Impedance Stability Network (L.I.S.N).
- The RBW of the receiver was set at 9 kHz in 150 kHz ~ 30MHz with Peak and AVG detector in Max Hold mode. Run the receiver's pre-scan to record the maximum disturbance generated from Product in all power lines in the full band.
- For each frequency whose maximum record was higher or close to limit, measure its QP and AVG values and record.

6.4 EUT Operating Conditions

The EUT was configured for testing in a typical fashion (as a customer would normally use it). The EUT has been programmed to continuously transmit during test. This operating condition was tested and used to collect the included data.

6.5 Test Result

Temperature:	26 °C	Relative Humidity:	54%
Pressure:	101KPa	Phase :	L
Test Mode:	Mode 1	Test Voltage :	AC120V/60Hz

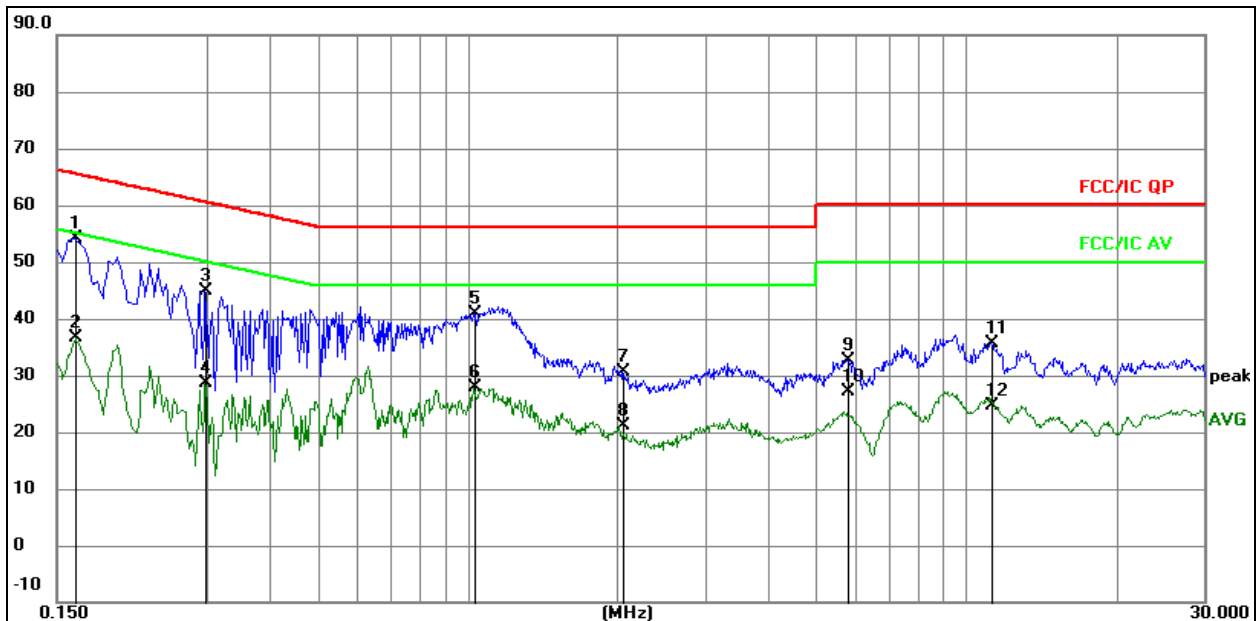

Remark:

1. All readings are Quasi-Peak and Average values.
2. Factor = Insertion Loss + Cable Loss.
3. Measurement=Reading Level+ Correct Factor
4. Over= Measurement-Limit

No.	Mk.	Freq. MHz	Reading Level	Correct Factor dB	Measure- ment dBuV	Limit dBuV	Over dB	Detector
1	*	0.1635	34.42	19.71	54.13	65.28	-11.15	QP
2		0.1635	16.89	19.71	36.60	55.28	-18.68	AVG
3		0.2985	25.21	19.77	44.98	60.28	-15.30	QP
4		0.2985	8.84	19.77	28.61	50.28	-21.67	AVG
5		1.0275	21.09	19.76	40.85	56.00	-15.15	QP
6		1.0275	8.18	19.76	27.94	46.00	-18.06	AVG
7		2.0535	10.78	19.89	30.67	56.00	-25.33	QP
8		2.0535	1.23	19.89	21.12	46.00	-24.88	AVG
9		5.7930	12.60	20.15	32.75	60.00	-27.25	QP
10		5.7930	6.99	20.15	27.14	50.00	-22.86	AVG
11		11.2470	15.41	20.28	35.69	60.00	-24.31	QP
12		11.2470	4.23	20.28	24.51	50.00	-25.49	AVG

Temperature:	26 °C	Relative Humidity:	54%
Pressure :	101kPa	Phase :	Neutral
Test Mode:	Mode 1	Test Voltage :	AC120V/60Hz

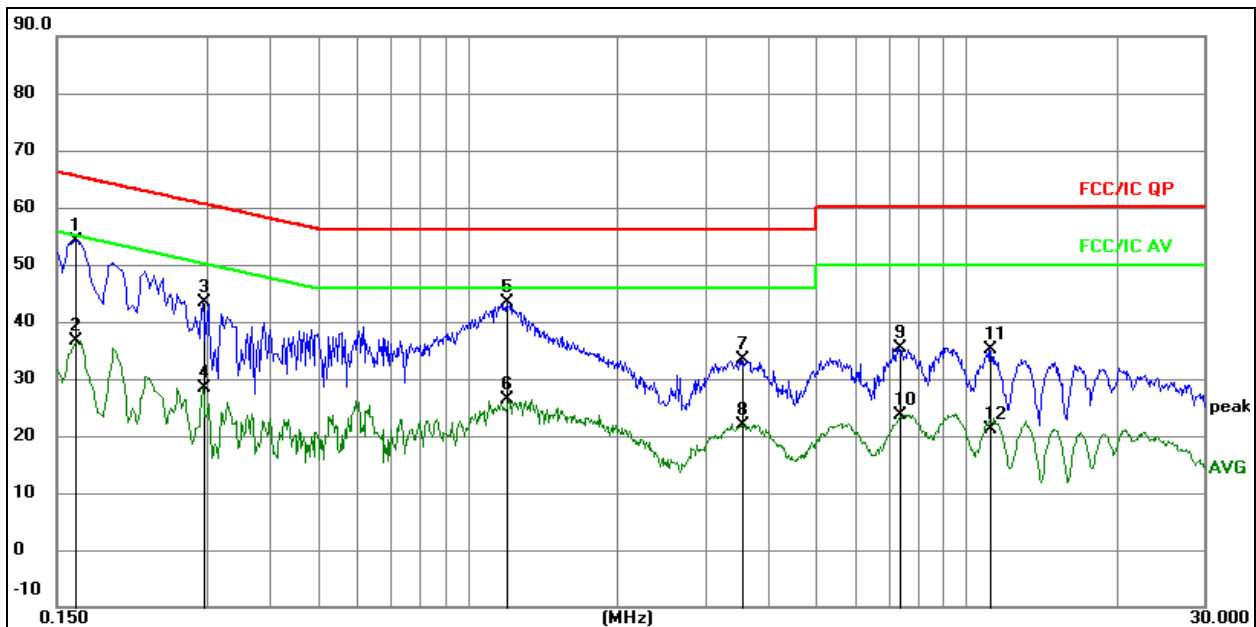
Remark:

1. All readings are Quasi-Peak and Average values.
2. Factor = Insertion Loss + Cable Loss.
3. Measurement=Reading Level+ Correct Factor
4. Over= Measurement-Limit

No.	Mk.	Freq. MHz	Reading Level	Correct Factor dB	Measure- ment dBuV	Limit dBuV	Over dB	Detector
1	*	0.1635	34.43	19.71	54.14	65.28	-11.14	QP
2		0.1635	16.95	19.71	36.66	55.28	-18.62	AVG
3		0.2940	23.70	19.77	43.47	60.41	-16.94	QP
4		0.2940	8.61	19.77	28.38	50.41	-22.03	AVG
5		1.1985	23.56	19.78	43.34	56.00	-12.66	QP
6		1.1985	6.53	19.78	26.31	46.00	-19.69	AVG
7		3.5475	13.44	20.05	33.49	56.00	-22.51	QP
8		3.5475	1.82	20.05	21.87	46.00	-24.13	AVG
9		7.3545	15.31	20.19	35.50	60.00	-24.50	QP
10		7.3545	3.48	20.19	23.67	50.00	-26.33	AVG
11		11.1840	14.93	20.28	35.21	60.00	-24.79	QP
12		11.1840	0.80	20.28	21.08	50.00	-28.92	AVG

7. Radiated Emissions

7.1 Block Diagram Of Test Setup

(A) Radiated Emission Test-Up Frequency Below 30MHz

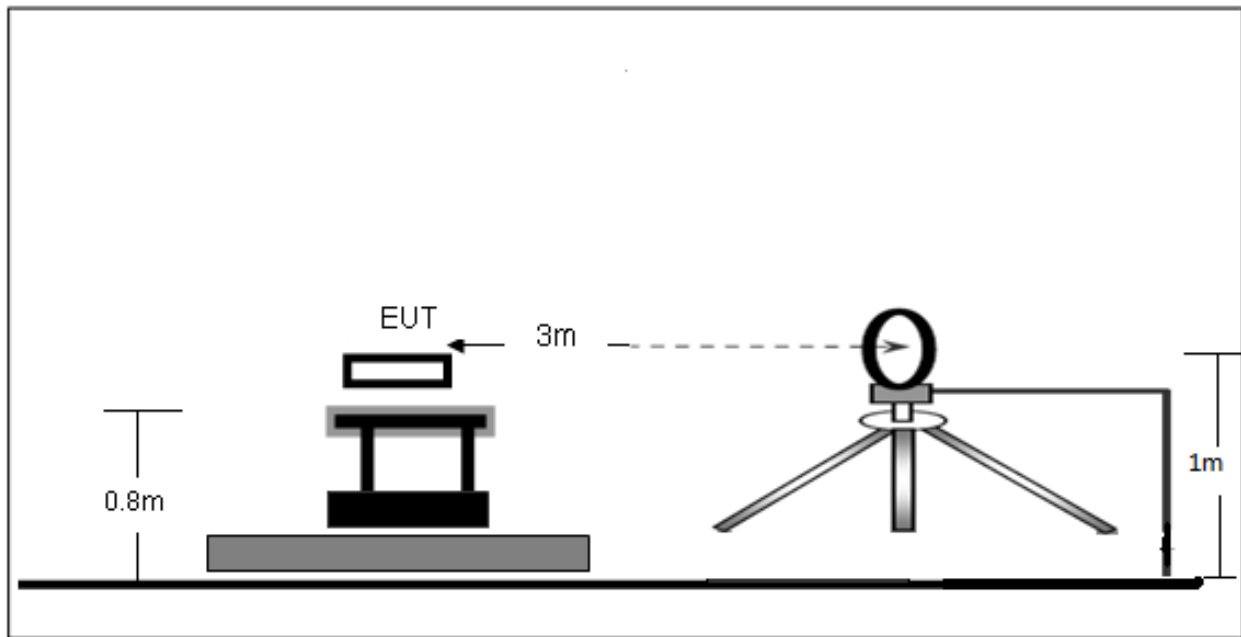

(B) Radiated Emission Test-Up Frequency 30MHz~1GHz

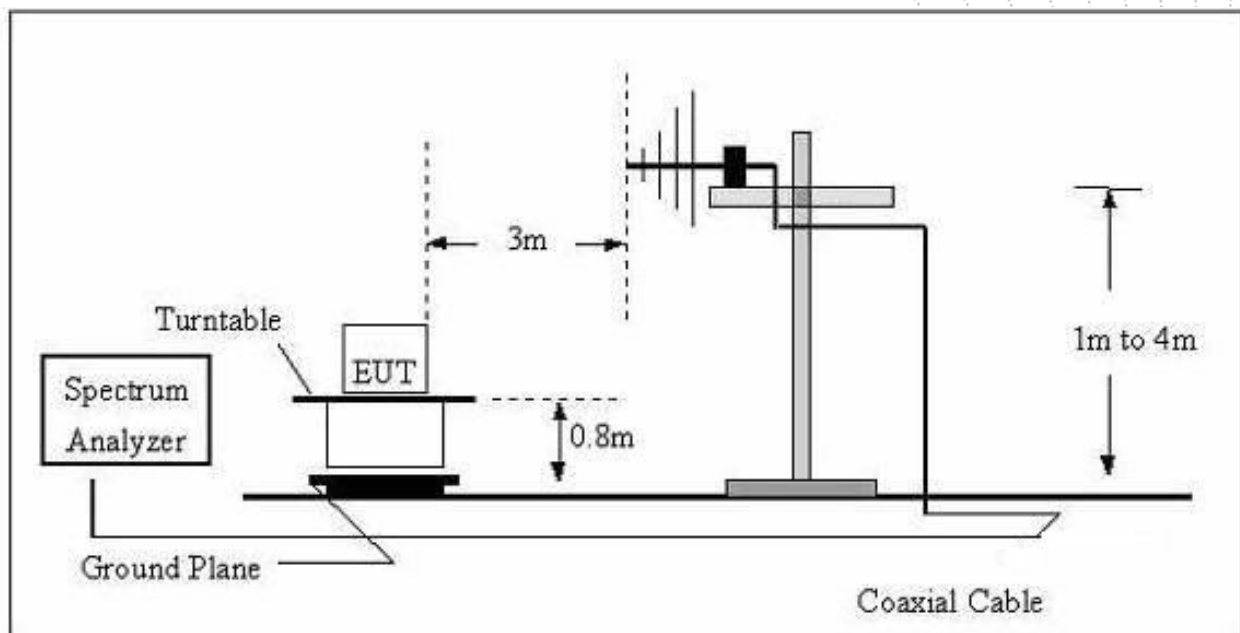

(C) Radiated Emission Test-Up Frequency Above 1GHz

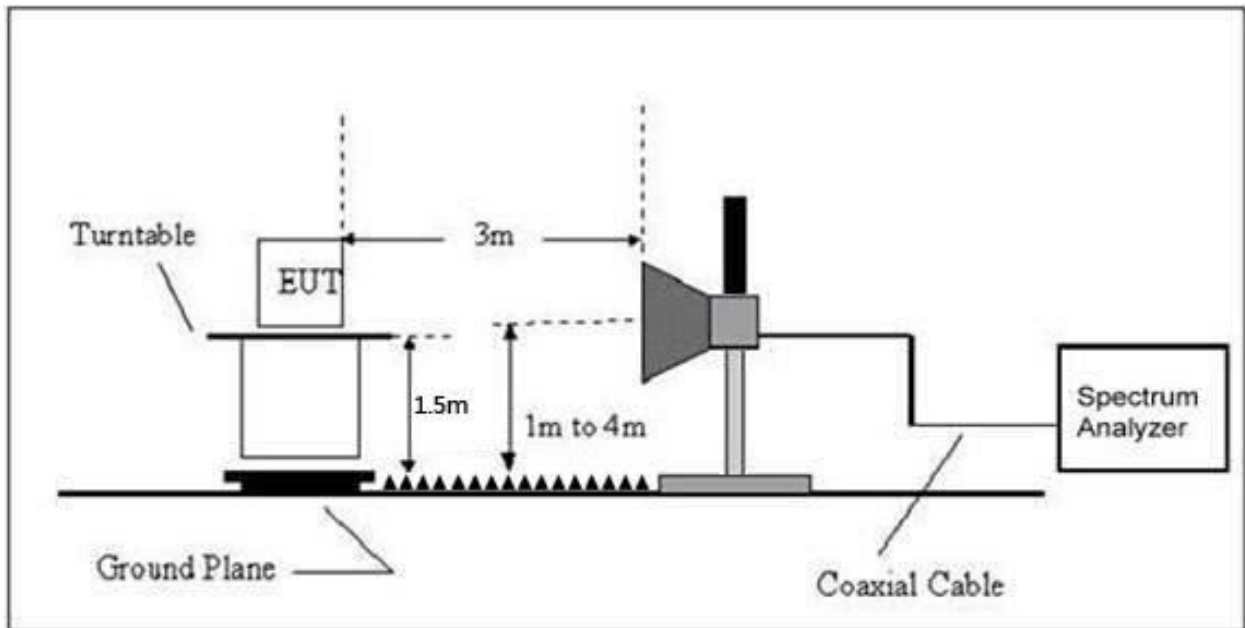

7.2 Limit

In case the emission fall within the restricted band specified on RSS-GEN, then the RSS-247 limit in the table below has to be followed.

Frequency (MHz)	Field Strength uV/m	Distance (m)	Field Strength Limit at 3m Distance	
			uV/m	dBuV/m
0.009 ~ 0.490	2400/F(kHz)	300	10000 * 2400/F(kHz)	20log ^{(2400/F(kHz))} + 80
0.490 ~ 1.705	24000/F(kHz)	30	100 * 24000/F(kHz)	20log ^{(24000/F(kHz))} + 40
1.705 ~ 30	30	30	100 * 30	20log ⁽³⁰⁾ + 40
30 ~ 88	100	3	100	20log ⁽¹⁰⁰⁾
88 ~ 216	150	3	150	20log ⁽¹⁵⁰⁾
216 ~ 960	200	3	200	20log ⁽²⁰⁰⁾
Above 960	500	3	500	20log ⁽⁵⁰⁰⁾

LIMITS OF RADIATED EMISSION MEASUREMENT (Above 1000MHz)

FREQUENCY (MHz)	Limit (dBuV/m) (at 3M)	
	PEAK	AVERAGE
Above 1000	74	54

Notes:

- (1) The limit for radiated test was performed according to ISED.
- (2) The tighter limit applies at the band edges.
- (3) Emission level (dBuV/m)=20log Emission level (uV/m).

Spectrum Parameter	Setting
Attenuation	Auto
Start Frequency	1000 MHz
Stop Frequency	25GHz
RB / VB (emission in restricted band)	1 MHz / 1 MHz for Peak, 1 MHz / 10Hz for Average

Receiver Parameter	Setting
Attenuation	Auto
Start ~ Stop Frequency	9kHz~150kHz / RB 200Hz for QP
Start ~ Stop Frequency	150kHz~30MHz / RB 9kHz for QP
Start ~ Stop Frequency	30MHz~1000MHz / RB 120kHz for QP

7.3 Test Procedure

Below 1GHz test procedure as below:

- a. The EUT was placed on the top of a rotating table 0.8 meters above the ground at a 3 meter semi-anechoic chamber. The table was rotated 360 degrees to determine the position of the highest radiation.
- b. The EUT was set 3 meters away from the interference-receiving antenna, which was mounted on the top of a variable-height antenna tower.
- c. The antenna height is varied from one meter to four meters above the ground to determine the maximum value of the field strength. Both horizontal and vertical polarizations of the antenna are set to make the measurement.
- d. For each suspected emission, the EUT was arranged to its worst case and then the antenna was tuned to heights from 1 meter to 4 meters (for the test frequency of below 30MHz, the antenna was tuned to heights 1 meter) and the rotatable table was turned from 0 degrees to 360 degrees to find the maximum reading.
- e. The test-receiver system was set to Peak Detect Function and Specified Bandwidth with Maximum Hold Mode.
- f. If the emission level of the EUT in peak mode was 10dB lower than the limit specified, then testing could be stopped and the peak values of the EUT would be reported. Otherwise the emissions that did not have 10dB margin would be re-tested one by one using peak, quasi-peak or average method as specified and then reported in a data sheet.

Above 1GHz test procedure as below:

- a. The EUT was placed on the top of a rotating table 1.5 meters above the ground at a 3 meter chamber. The table was rotated 360 degrees to determine the position of the highest radiation.
- b. The EUT was set 3 meters away from the interference-receiving antenna, which was mounted on the top of a variable-height antenna tower.
- c. The antenna height is varied from one meter to four meters above the ground to determine the maximum value of the field strength. Both horizontal and vertical polarizations of the antenna are set to make the measurement.
- d. For each suspected emission, the EUT was arranged to its worst case and then the antenna was tuned to heights from 1 meter to 4 meters and the rota table was turned from 0 degrees to 360 degrees to find the maximum reading.
- e. The test-receiver system was set to Peak Detect Function and Specified Bandwidth with Maximum Hold Mode.
- f. If the emission level of the EUT in peak mode was 10dB lower than the limit specified, then testing could be stopped and the peak values of the EUT would be reported. Otherwise the emissions that did not have 10dB margin would be re-tested one by one using peak, quasi-peak or average method as specified and then reported in a data sheet.
- g. Test the EUT in the lowest channel, the middle channel, the Highest channel.

Note:

Both horizontal and vertical antenna polarities were tested and performed pretest to three orthogonal axis. The worst case emissions were reported.

7.4 EUT Operating Conditions

The EUT was configured for testing in a typical fashion (as a customer would normally use it). The EUT has been programmed to continuously transmit during test. This operating condition was tested and used to collect the included data.

7.5 Test Result

Below 30MHz

Temperature:	26°C	Relative Humidity:	24%
Pressure:	101 kPa	Test Voltage :	AC120V/60Hz
Test Mode :	Mode 1	Polarization :	--

Freq. (MHz)	Reading (dBuV/m)	Limit (dBuV/m)	Margin (dB)	State P/F
--	--	--	--	PASS
--	--	--	--	PASS

Note:

The amplitude of spurious emissions which are attenuated by more than 20dB below the permissible value has no need to be reported.

Distance extrapolation factor = $40 \log(\text{specific distance/test distance})$ (dB);

Limit line = specific limits(dBuv) + distance extrapolation factor.

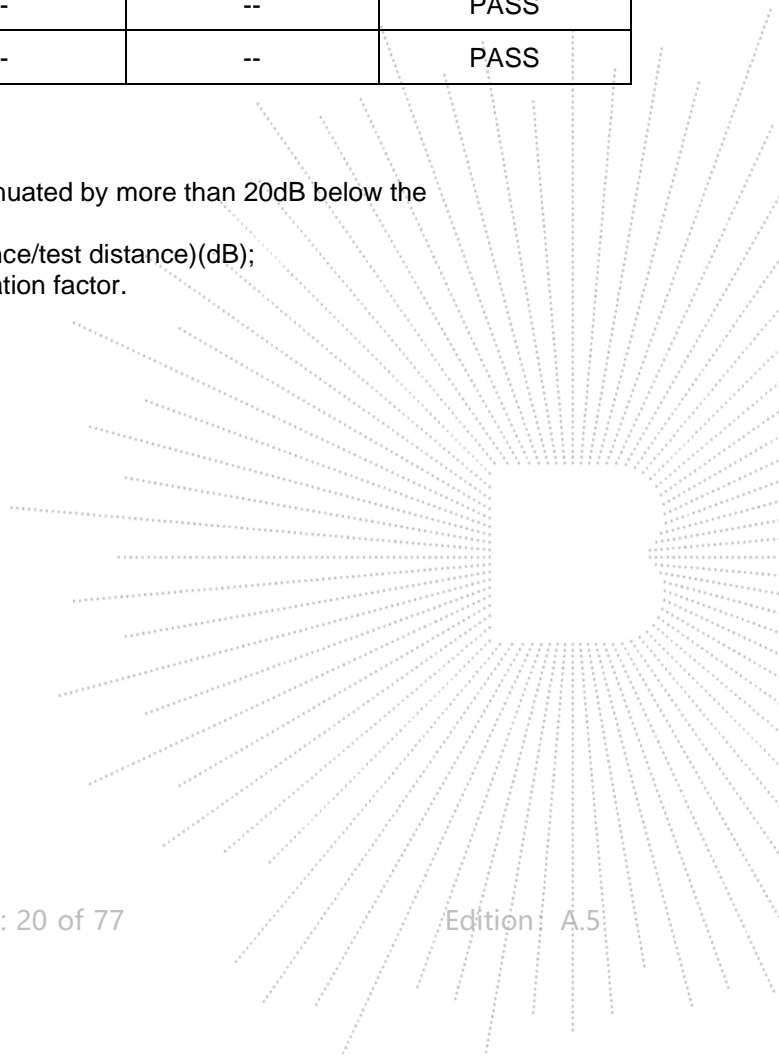

Between 30MHz – 1GHz

Temperature:	26 °C	Relative Humidity:	54%
Pressure:	101KPa	Phase :	Horizontal
Test Mode:	Mode 1	Test Voltage :	AC120V/60Hz

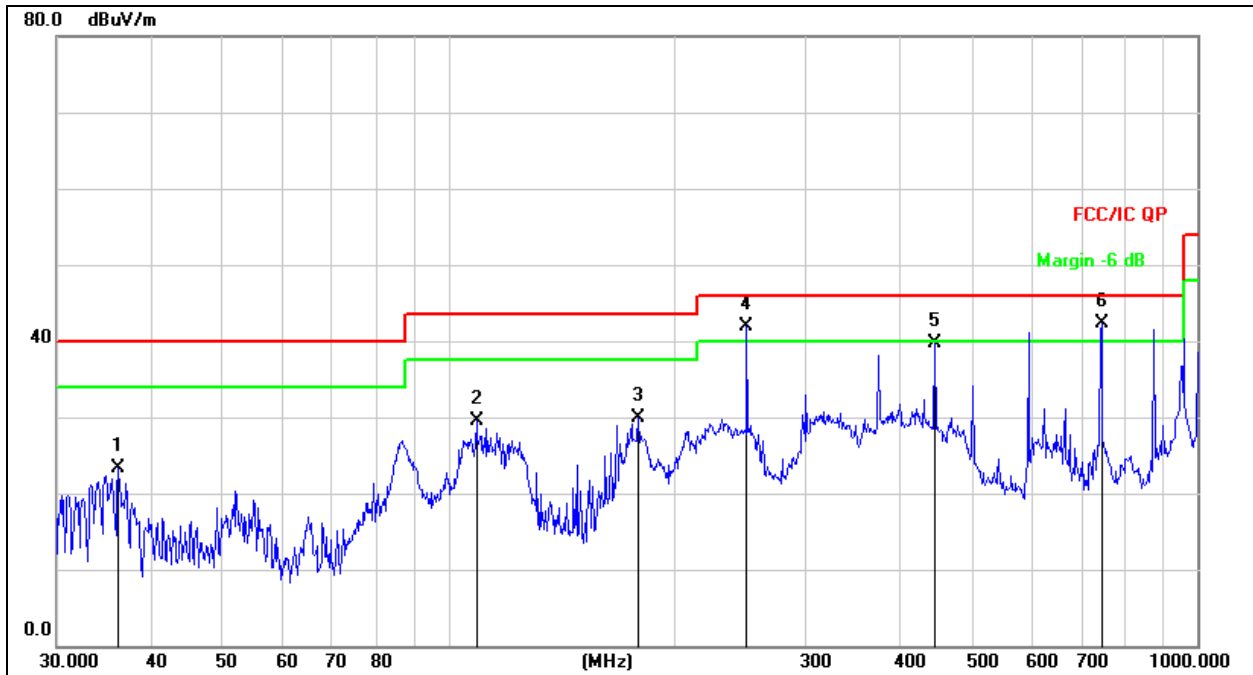

Remark:

1. Factor = Antenna Factor + Cable Loss – Pre-amplifier.
2. Measurement=Reading Level+ Correct Factor
3. Over= Measurement-Limit

No.	Mk.	Freq. MHz	Reading Level dBuV	Correct Factor dB	Measure- ment dBuV/m	Limit dB/m	Over dB	Detector
1		36.2541	40.65	-17.34	23.31	40.00	-16.69	QP
2		109.0286	47.79	-18.35	29.44	43.50	-14.06	QP
3		179.3863	48.84	-18.89	29.95	43.50	-13.55	QP
4	!	250.3012	57.65	-15.82	41.83	46.00	-4.17	QP
5		446.4141	51.27	-11.54	39.73	46.00	-6.27	QP
6	*	744.8661	48.71	-6.45	42.26	46.00	-3.74	QP

Temperature:	26 °C	Relative Humidity:	54%
Pressure:	101KPa	Phase :	Vertical
Test Mode:	Mode 1	Test Voltage :	AC120V/60Hz

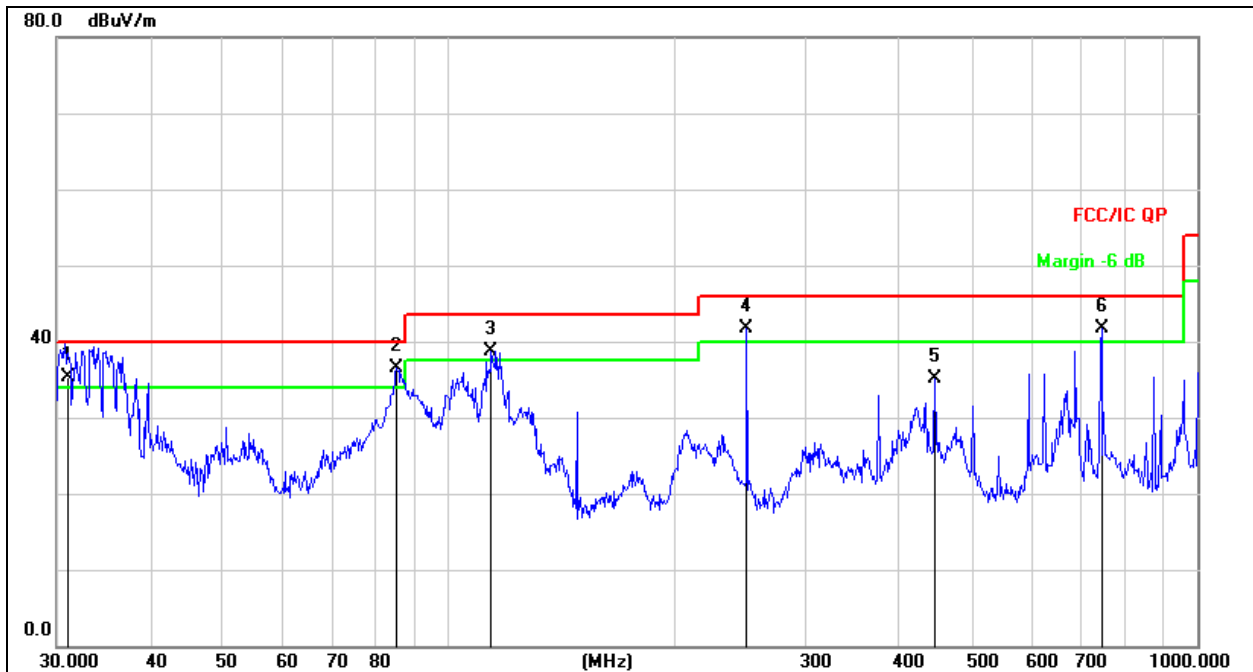

Remark:
 1. Factor = Antenna Factor + Cable Loss – Pre-amplifier.
 2. Measurement=Reading Level+ Correct Factor
 3. Over= Measurement-Limit

No.	Mk.	Freq. MHz	Reading Level dBuV	Correct Factor dB	Measure- ment dBuV/m	Limit dB/m	Over dB	Detector
1	!	31.1150	53.59	-18.19	35.40	40.00	-4.60	QP
2	*	85.2980	56.86	-20.33	36.53	40.00	-3.47	QP
3	!	114.1137	57.42	-18.69	38.73	43.50	-4.77	QP
4	!	250.3012	57.50	-15.82	41.68	46.00	-4.32	QP
5		446.4141	46.62	-11.54	35.08	46.00	-10.92	QP
6	!	744.8661	48.17	-6.45	41.72	46.00	-4.28	QP

Between 1GHz – 25GHz

802.11b

Polar (H/V)	Frequency	Reading Level	Correct Factor	Measure- ment	Limits	Over	Detector Type
	(MHz)	(dBuV/m)	(dB)	(dBuV/m)	(dBuV/ m)	(dB)	
Low channel:2412MHz							
V	4824.00	53.59	-0.43	53.16	74.00	-20.84	PK
V	4824.00	43.03	-0.43	42.60	54.00	-11.40	AV
V	7236.00	43.01	8.31	51.32	74.00	-22.68	PK
V	7236.00	32.23	8.31	40.54	54.00	-13.46	AV
H	4824.00	49.83	-0.43	49.40	74.00	-24.60	PK
H	4824.00	38.91	-0.43	38.48	54.00	-15.52	AV
H	7236.00	40.13	8.31	48.44	74.00	-25.56	PK
H	7236.00	31.21	8.31	39.52	54.00	-14.48	AV
Middle channel:2437MHz							
V	4874.00	50.25	-0.38	49.87	74.00	-24.13	PK
V	4874.00	41.26	-0.38	40.88	54.00	-13.12	AV
V	7311.00	39.92	8.83	48.75	74.00	-25.25	PK
V	7311.00	30.28	8.83	39.11	54.00	-14.89	AV
H	4874.00	49.09	-0.38	48.71	74.00	-25.29	PK
H	4874.00	39.73	-0.38	39.35	54.00	-14.65	AV
H	7311.00	38.37	8.83	47.20	74.00	-26.80	PK
H	7311.00	29.58	8.83	38.41	54.00	-15.59	AV
High channel:2462MHz							
V	4924.00	53.13	-0.32	52.81	74.00	-21.19	PK
V	4924.00	43.81	-0.32	43.49	54.00	-10.51	AV
V	7386.00	47.10	9.35	56.45	74.00	-17.55	PK
V	7386.00	36.92	9.35	46.27	54.00	-7.73	AV
H	4924.00	50.17	-0.32	49.85	74.00	-24.15	PK
H	4924.00	40.43	-0.32	40.11	54.00	-13.89	AV
H	7386.00	44.12	9.35	53.47	74.00	-20.53	PK
H	7386.00	36.00	9.35	45.35	54.00	-8.65	AV

Remark:

1. Emission Level = Meter Reading + Factor,

Factor = Antenna Factor + Cable Loss – Pre-amplifier.

Over = Emission Level - Limit

2. If peak below the average limit, the average emission was no test.

3. In restricted bands of operation, The spurious emissions below the permissible value more than 20dB

4. The amplitude of spurious emissions which are attenuated by more than 20dB below the permissible value has no need to be reported.

802.11g

Polar (H/V)	Frequency	Reading Level	Correct Factor	Measure- ment	Limits	Over	Detector Type
	(MHz)	(dBuV/m)	(dB)	(dBuV/m)	(dBuV/ m)	(dB)	
Low channel:2412MHz							
V	4824.00	54.14	-0.43	53.71	74.00	-20.29	PK
V	4824.00	44.52	-0.43	44.09	54.00	-9.91	AV
V	7236.00	43.89	8.31	52.20	74.00	-21.80	PK
V	7236.00	33.07	8.31	41.38	54.00	-12.62	AV
H	4824.00	49.56	-0.43	49.13	74.00	-24.87	PK
H	4824.00	39.69	-0.43	39.26	54.00	-14.74	AV
H	7236.00	42.14	8.31	50.45	74.00	-23.55	PK
H	7236.00	35.02	8.31	43.33	54.00	-10.67	AV
Middle channel:2437MHz							
V	4874.00	52.88	-0.38	52.50	74.00	-21.50	PK
V	4874.00	44.94	-0.38	44.56	54.00	-9.44	AV
V	7311.00	42.42	8.83	51.25	74.00	-22.75	PK
V	7311.00	34.23	8.83	43.06	54.00	-10.94	AV
H	4874.00	51.13	-0.38	50.75	74.00	-23.25	PK
H	4874.00	40.32	-0.38	39.94	54.00	-14.06	AV
H	7311.00	40.15	8.83	48.98	74.00	-25.02	PK
H	7311.00	31.91	8.83	40.74	54.00	-13.26	AV
High channel:2462MHz							
V	4924.00	53.99	-0.32	53.67	74.00	-20.33	PK
V	4924.00	44.87	-0.32	44.55	54.00	-9.45	AV
V	7386.00	47.37	9.35	56.72	74.00	-17.28	PK
V	7386.00	38.33	9.35	47.68	54.00	-6.32	AV
H	4924.00	51.34	-0.32	51.02	74.00	-22.98	PK
H	4924.00	42.33	-0.32	42.01	54.00	-11.99	AV
H	7386.00	44.99	9.35	54.34	74.00	-19.66	PK
H	7386.00	36.39	9.35	45.74	54.00	-8.26	AV

Remark:

1. Emission Level = Meter Reading + Factor,
Factor = Antenna Factor + Cable Loss – Pre-amplifier.
Over= Emission Level - Limit
2. If peak below the average limit, the average emission was no test.
3. In restricted bands of operation, The spurious emissions below the permissible value more than 20dB
4. The amplitude of spurious emissions which are attenuated by more than 20dB below the permissible value has no need to be reported.

802.11n20

Polar (H/V)	Frequency	Reading Level	Correct Factor	Measure- ment	Limits	Over	Detector Type
	(MHz)	(dBuV/m)	(dB)	(dBuV/m)	(dBuV/ m)	(dB)	
Low channel:2412MHz							
V	4824.00	54.91	-0.43	54.48	74.00	-19.52	PK
V	4824.00	46.87	-0.43	46.44	54.00	-7.56	AV
V	7236.00	47.04	8.31	55.35	74.00	-18.65	PK
V	7236.00	36.20	8.31	44.51	54.00	-9.49	AV
H	4824.00	53.53	-0.43	53.10	74.00	-20.90	PK
H	4824.00	43.51	-0.43	43.08	54.00	-10.92	AV
H	7236.00	45.72	8.31	54.03	74.00	-19.97	PK
H	7236.00	37.22	8.31	45.53	54.00	-8.47	AV
Middle channel:2437MHz							
V	4874.00	51.93	-0.38	51.55	74.00	-22.45	PK
V	4874.00	44.52	-0.38	44.14	54.00	-9.86	AV
V	7311.00	41.99	8.83	50.82	74.00	-23.18	PK
V	7311.00	32.88	8.83	41.71	54.00	-12.29	AV
H	4874.00	46.95	-0.38	46.57	74.00	-27.43	PK
H	4874.00	37.43	-0.38	37.05	54.00	-16.95	AV
H	7311.00	39.44	8.83	48.27	74.00	-25.73	PK
H	7311.00	32.12	8.83	40.95	54.00	-13.05	AV
High channel:2462MHz							
V	4924.00	53.53	-0.32	53.21	74.00	-20.79	PK
V	4924.00	44.14	-0.32	43.82	54.00	-10.18	AV
V	7386.00	45.27	9.35	54.62	74.00	-19.38	PK
V	7386.00	35.09	9.35	44.44	54.00	-9.56	AV
H	4924.00	51.97	-0.32	51.65	74.00	-22.35	PK
H	4924.00	41.77	-0.32	41.45	54.00	-12.55	AV
H	7386.00	42.49	9.35	51.84	74.00	-22.16	PK
H	7386.00	33.56	9.35	42.91	54.00	-11.09	AV

Remark:

1. Emission Level = Meter Reading + Factor,
 Factor = Antenna Factor + Cable Loss – Pre-amplifier.
 Over = Emission Level - Limit

2. If peak below the average limit, the average emission was no test.

3. In restricted bands of operation, The spurious emissions below the permissible value more than 20dB

4. The amplitude of spurious emissions which are attenuated by more than 20dB below the permissible value has no need to be reported.

8. Radiated Band Emission Measurement And Restricted Bands Of Operation

8.1 Block Diagram Of Test Setup

Radiated Emission Test-Up Frequency Above 1GHz

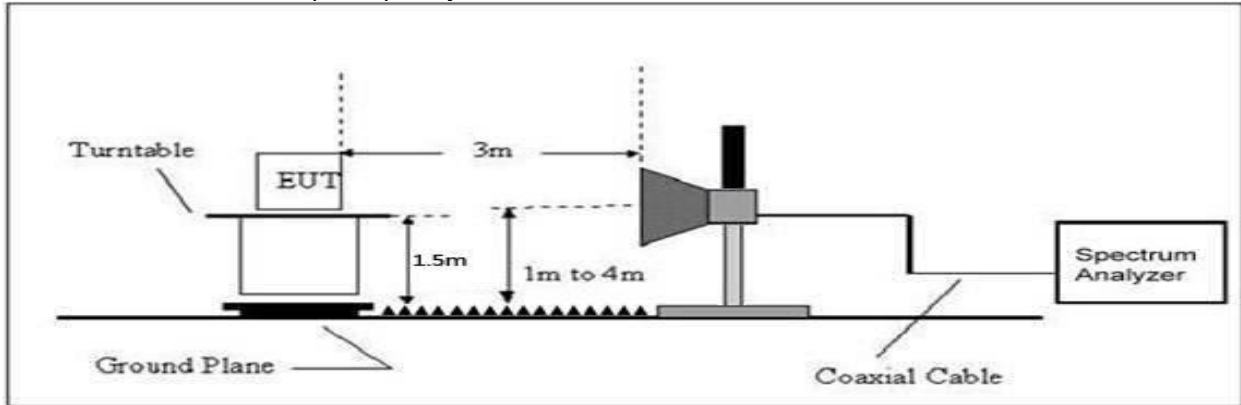

8.2 Limit

RSS-GEN, RSS-247

Table 7 – Restricted frequency bands*

MHz	MHz	GHz
0.090 - 0.110	149.9 - 150.05	9.0 - 9.2
0.495 - 0.505	156.52475 - 156.52525	9.3 - 9.5
2.1735 - 2.1905	156.7 - 156.9	10.6 - 12.7
3.020 - 3.026	162.0125 - 167.17	13.25 - 13.4
4.125 - 4.128	167.72 - 173.2	14.47 - 14.5
4.17725 - 4.17775	240 - 285	15.35 - 16.2
4.20725 - 4.20775	322 - 335.4	17.7 - 21.4
5.677 - 5.683	399.9 - 410	22.01 - 23.12
6.215 - 6.218	608 - 614	23.6 - 24.0
6.26775 - 6.26825	960 - 1427	31.2 - 31.8
6.31175 - 6.31225	1435 - 1626.5	36.43 - 36.5
8.291 - 8.294	1645.5 - 1646.5	Above 38.6
8.362 - 8.366	1660 - 1710	
8.37625 - 8.38675	1718.8 - 1722.2	
8.41425 - 8.41475	2200 - 2300	
12.29 - 12.293	2310 - 2390	
12.51975 - 12.52025	2483.5 - 2500	
12.57675 - 12.57725	2655 - 2900	
13.36 - 13.41	3260 - 3267	
16.42 - 16.423	3332 - 3339	
16.69475 - 16.69525	3345.8 - 3358	
16.80425 - 16.80475	3500 - 4400	
25.5 - 25.67	4500 - 5150	
37.5 - 38.25	5350 - 5460	
73 - 74.6	7250 - 7750	
74.8 - 75.2	8025 - 8500	
108 - 138	--	

* Certain frequency bands listed in table 7 and in bands above 38.6 GHz are designated for licence-exempt applications. These frequency bands and the requirements that apply to related devices are set out in the 200 and 300 series of RSSs.

LIMITS OF RADIATED EMISSION MEASUREMENT (Above 1000MHz)

FREQUENCY (MHz)	Limit (dBuV/m) (at 3M)	
	PEAK	AVERAGE
Above 1000	74	54

Notes:

- (1)The limit for radiated test was performed according to ISED.
- (2)The tighter limit applies at the band edges.
- (3)Emission level (dBuV/m)=20log Emission level (uV/m).

8.3 Test Procedure

Receiver Parameter	Setting
Attenuation	Auto
Start Frequency	2300MHz
Stop Frequency	2520
RB / VB (emission in restricted band)	1 MHz / 1 MHz for Peak, 1 MHz / 10Hz for Average

Above 1GHz test procedure as below:

- a.The EUT was placed on the top of a rotating table 1.5 meters above the ground at a 3 meter camber. The table was rotated 360 degrees to determine the position of the highest radiation.
- b.The EUT was set 3 meters away from the interference-receiving antenna, which was mounted on the top of a variable-height antenna tower.
- c.The antenna height is varied from one meter to four meters above the ground to determine the maximum value of the field strength. Both horizontal and vertical polarizations of the antenna are set to make the measurement.
- d.For each suspected emission, the EUT was arranged to its worst case and then the antenna was tuned to heights from 1 meter to 4 meters and the rota table was turned from 0 degrees to 360 degrees to find the maximum reading.
- e.The test-receiver system was set to Peak Detect Function and Specified Bandwidth with Maximum Hold Mode.
- f. If the emission level of the EUT in peak mode was 10dB lower than the limit specified, then testing could be stopped and the peak values of the EUT would be reported. Otherwise the emissions that did not have 10dB margin would be re-tested one by one using peak, quasi-peak or average method as specified and then reported in a data sheet.
- g.Test the EUT in the lowest channel,the Highest channel.

Note:

Both horizontal and vertical antenna polarities were tested and performed pretest to three orthogonal axis. The worst case emissions were reported.

8.4 EUT Operating Conditions

The EUT tested system was configured as the statements of 2.3 Unless otherwise a special operating condition is specified in the follows during the testing.

8.5 Test Result

	Polar (H/V)	Frequency (MHz)	Reading Level (dBuV/m)	Correct Factor (dB)	Measurement (dBuV/m)		Measurement (dBuV/m)		Over	Result	
					PK	PK	AV	PK			
802.11b	Low Channel 2412MHz										
	H	2390.00	53.32	-6.70	46.62	74.00	54.00	-22.86	PASS		
	H	2400.00	57.61	-6.71	50.90	74.00	54.00	-30.94	PASS		
	V	2390.00	53.45	-6.70	46.75	74.00	54.00	-22.98	PASS		
	V	2400.00	56.53	-6.71	49.82	74.00	54.00	-30.91	PASS		
	High Channel 2462MHz										
	H	2483.50	56.93	-6.79	50.14	74.00	54.00	-23.92	PASS		
	H	2500.00	52.66	-6.81	45.85	74.00	54.00	-31.92	PASS		
	V	2483.50	56.70	-6.79	49.91	74.00	54.00	-23.03	PASS		
	V	2500.00	52.24	-6.81	45.43	74.00	54.00	-32.00	PASS		
	802.11g	Low Channel 2412MHz									
		H	2390.00	53.94	-6.70	47.24	74.00	54.00	-23.37	PASS	
H		2400.00	57.39	-6.71	50.68	74.00	54.00	-31.83	PASS		
V		2390.00	53.31	-6.70	46.61	74.00	54.00	-22.70	PASS		
V		2400.00	57.60	-6.71	50.89	74.00	54.00	-29.86	PASS		
High Channel 2462MHz											
H		2483.50	56.78	-6.79	49.99	74.00	54.00	-23.89	PASS		
H		2500.00	53.35	-6.81	46.54	74.00	54.00	-30.92	PASS		
V		2483.50	57.10	-6.79	50.31	74.00	54.00	-24.60	PASS		
V		2500.00	52.16	-6.81	45.35	74.00	54.00	-32.81	PASS		

Remark:

- Emission Level = Meter Reading + Factor,
Factor = Antenna Factor + Cable Loss – Pre-amplifier.
Over= Measurement – Limit
- If the PK measured levels comply with average limit, then the average level were deemed to comply with average limit.
- In restricted bands of operation, The spurious emissions below the permissible value more than 20dB
- The amplitude of spurious emissions which are attenuated by more than 20dB below the permissible value has no need to be reported.

	Polar (H/V)	Frequency (MHz)	Reading Level (dBuV/m)	Correct Factor (dB)	Measurement (dBuV/m)	Measurement (dBuV/m)		Over	Result
					PK	PK	AV	PK	
802.11 n20	Low Channel 2412MHz								
	H	2390.00	54.60	-6.70	47.90	74.00	54.00	-22.96	PASS
	H	2400.00	57.61	-6.71	50.90	74.00	54.00	-31.62	PASS
	V	2390.00	54.18	-6.70	47.48	74.00	54.00	-23.59	PASS
	V	2400.00	58.28	-6.71	51.57	74.00	54.00	-32.42	PASS
	High Channel 2462MHz								
	H	2483.50	57.10	-6.79	50.31	74.00	54.00	-23.76	PASS
	H	2500.00	53.28	-6.81	46.47	74.00	54.00	-30.80	PASS
	V	2483.50	57.77	-6.79	50.98	74.00	54.00	-23.91	PASS
	V	2500.00	53.84	-6.81	47.03	74.00	54.00	-31.84	PASS

Remark:

1. Emission Level = Meter Reading + Factor,
Factor = Antenna Factor + Cable Loss – Pre-amplifier.
Over= Measurement – Limit
2. If the PK measured levels comply with average limit, then the average level were deemed to comply with average limit.
- 3 In restricted bands of operation, The spurious emissions below the permissible value more than 20dB
4. The amplitude of spurious emissions which are attenuated by more than 20dB below the permissible value has no need to be reported.

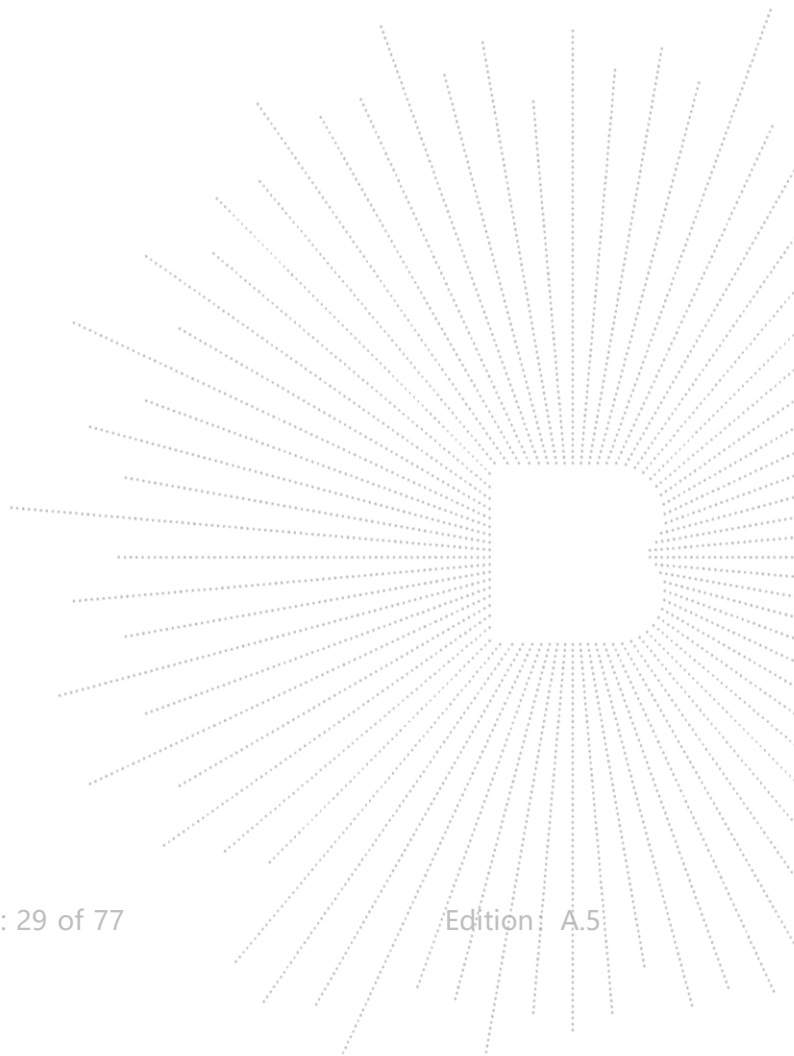

9. Power Spectral Density Test

9.1 Block Diagram Of Test Setup

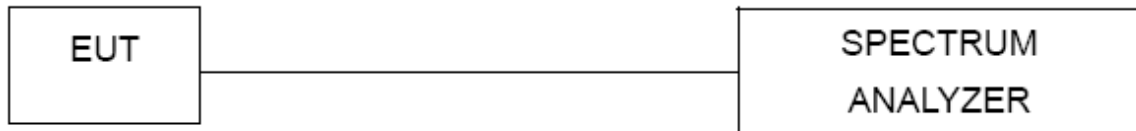

9.2 Limit

RSS-247 5.2				
Section	Test Item	Limit	Frequency Range (MHz)	Result
RSS-247 5.2	Power Spectral Density	8 dBm (in any 3KHz)	2400-2483.5	PASS

LIMITS OF RADIATED EMISSION MEASUREMENT (Above 1000MHz)

9.3 Test Procedure

1. Set analyzer center frequency to DTS channel center frequency.
2. Set the span to 1.5 times the DTS bandwidth.
3. Set the RBW to: $3 \text{ kHz} \leq \text{RBW} \leq 100 \text{ kHz}$.
4. Set the VBW $\geq 3 \times \text{RBW}$.
5. Detector = peak.
6. Sweep time = auto couple.
7. Trace mode = max hold.
8. Allow trace to fully stabilize.
9. Use the peak marker function to determine the maximum amplitude level within the RBW.
10. If measured value exceeds limit, reduce RBW (no less than 3 kHz) and repeat.

9.4 EUT Operating Conditions

The EUT tested system was configured as the statements of 4.6 Unless otherwise a special operating condition is specified in the follows during the testing.

Note: Power Spectral Density(dBm)=Reading+Cable Loss

9.5 Test Result

Temperature :	26°C	Relative Humidity :	54%
Pressure :	101kPa	Test Voltage :	DC 5V

Condition	Mode	Frequency	Power Spectral Density (dBm/10kHz)	Power Spectral Density (dBm/3kHz)	Limit (dBm/3kHz)	Result
NVNT	b	2412 MHz	-3.8	-9.03	8	PASS
NVNT	b	2437 MHz	-3.65	-8.88	8	PASS
NVNT	b	2462 MHz	-3.77	-9.00	8	PASS
NVNT	g	2412 MHz	-6.39	-11.62	8	PASS
NVNT	g	2437 MHz	-5.46	-10.69	8	PASS
NVNT	g	2462 MHz	-6.07	-11.30	8	PASS
NVNT	n20	2412 MHz	-6.34	-11.57	8	PASS
NVNT	n20	2437 MHz	-7.37	-12.60	8	PASS
NVNT	n20	2462 MHz	-6.02	-11.25	8	PASS

Note: Correction Factor = $10\log(3\text{kHz}/\text{RBW in measurement}) = -5.23$
 Power Spectral Density(dBm/3kHz) = Power Spectral Density(dBm/10kHz) + Correction Factor

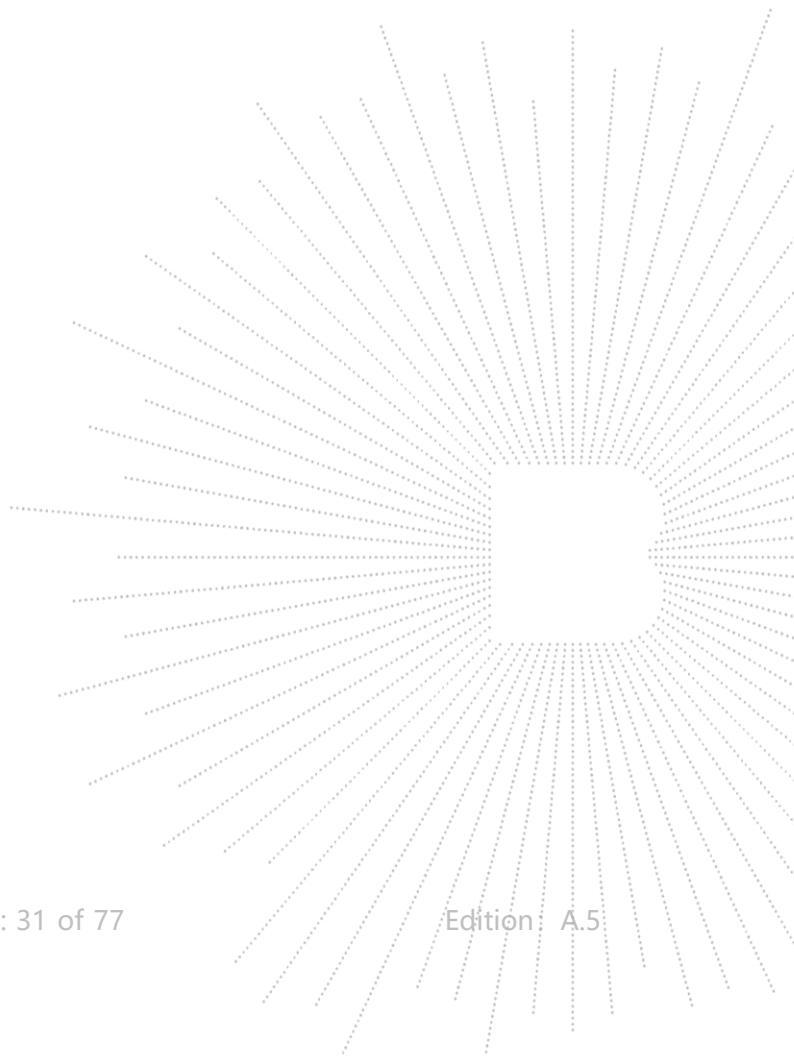

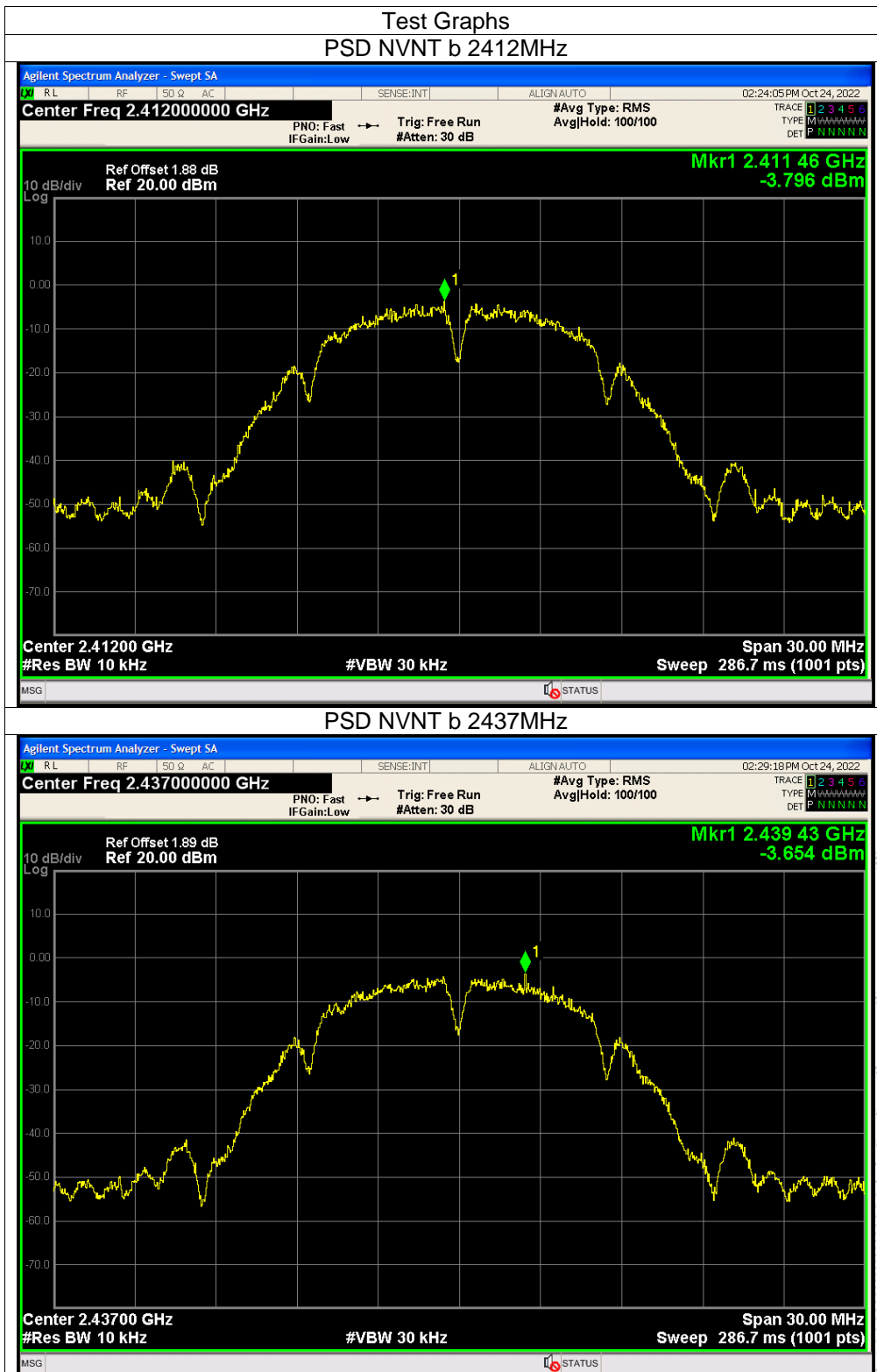

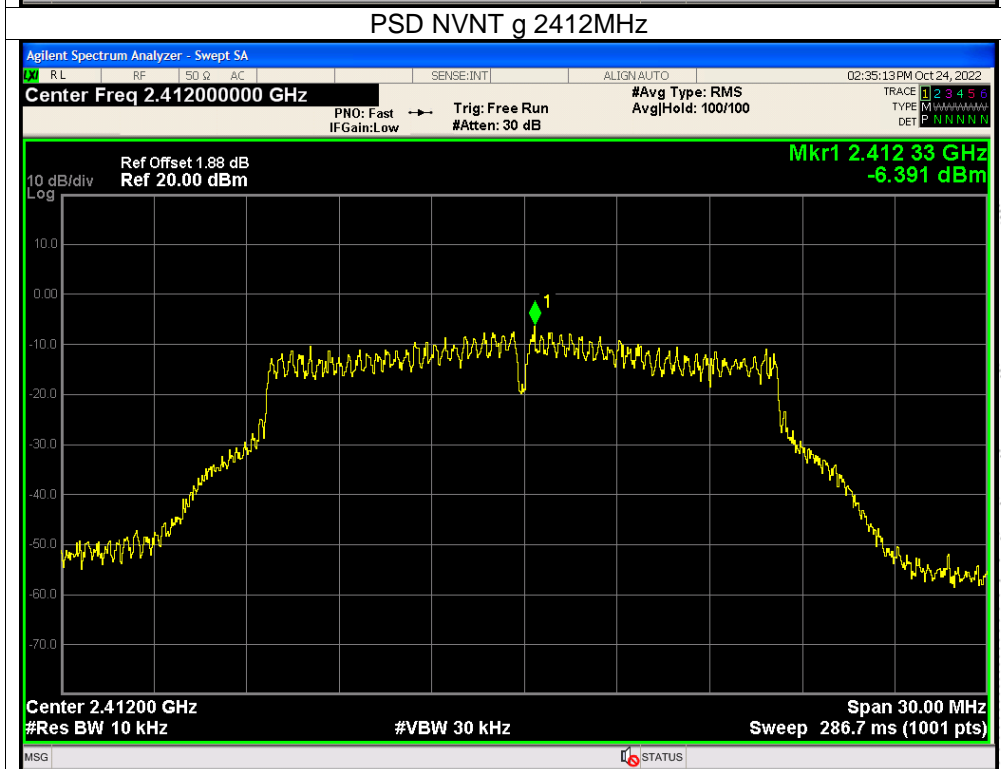
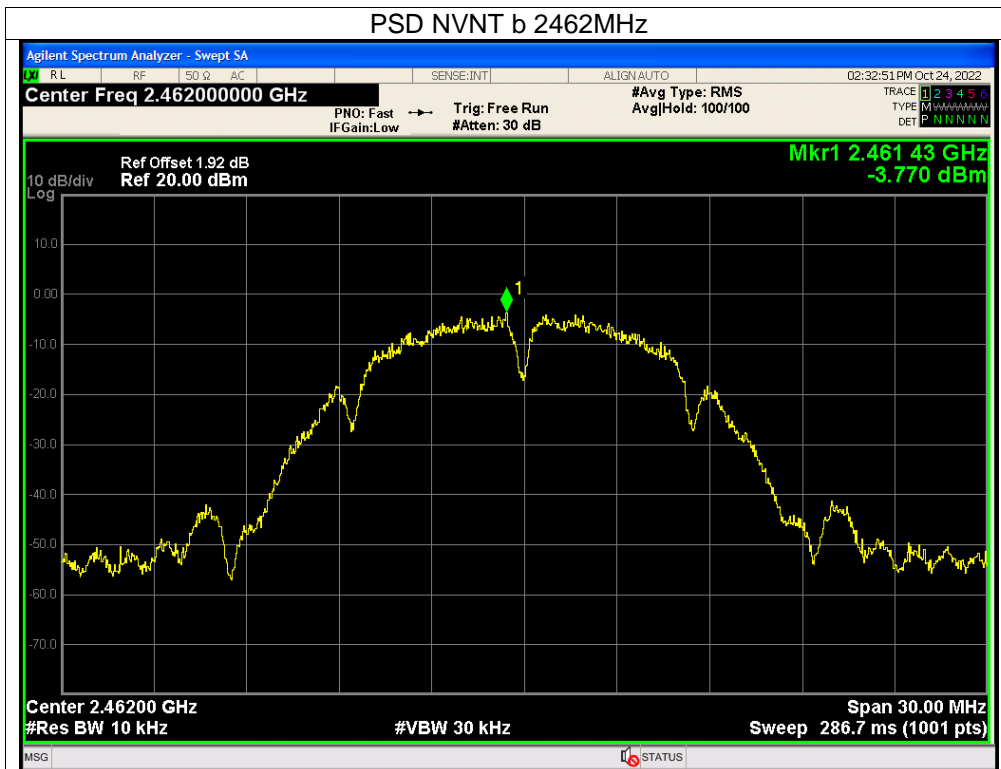

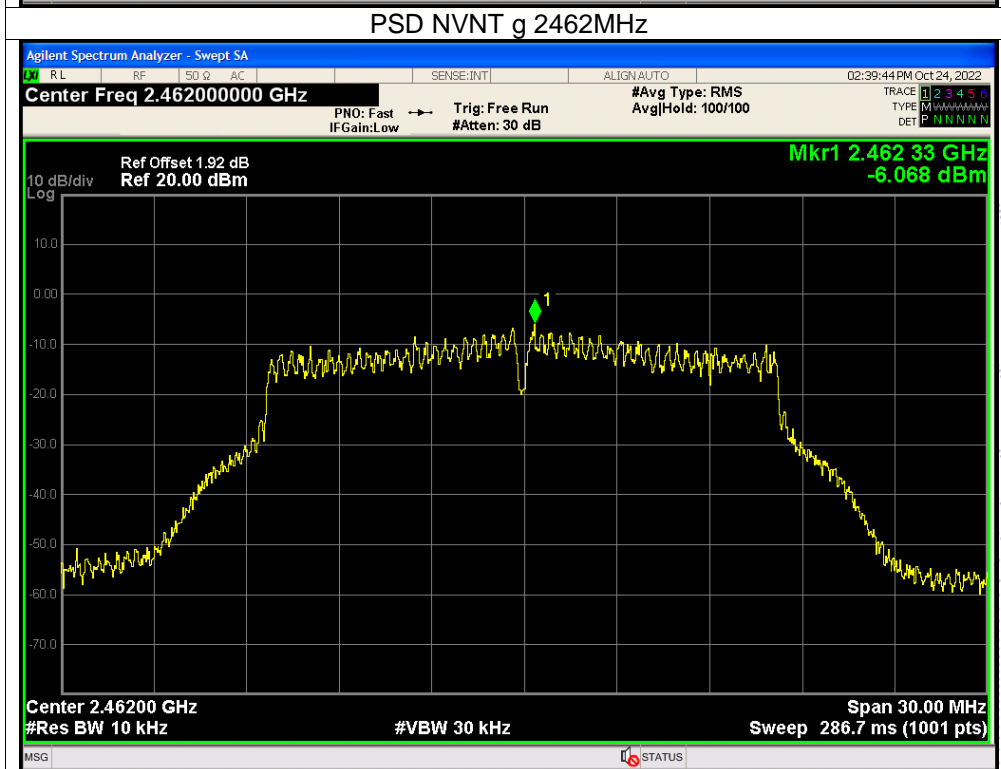
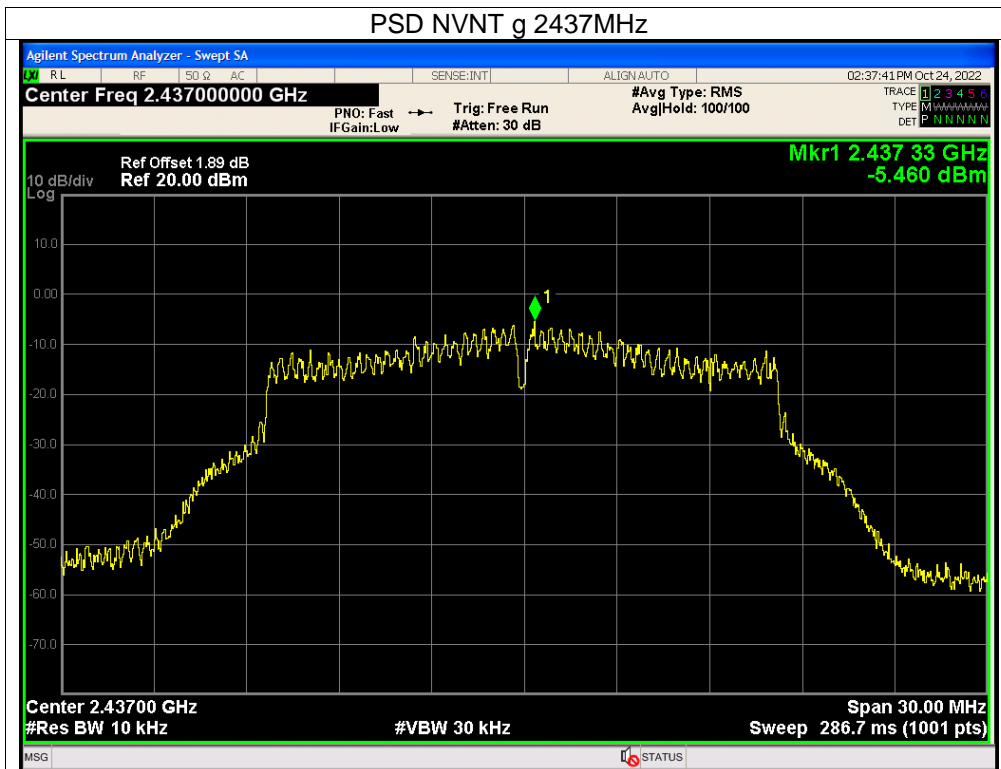

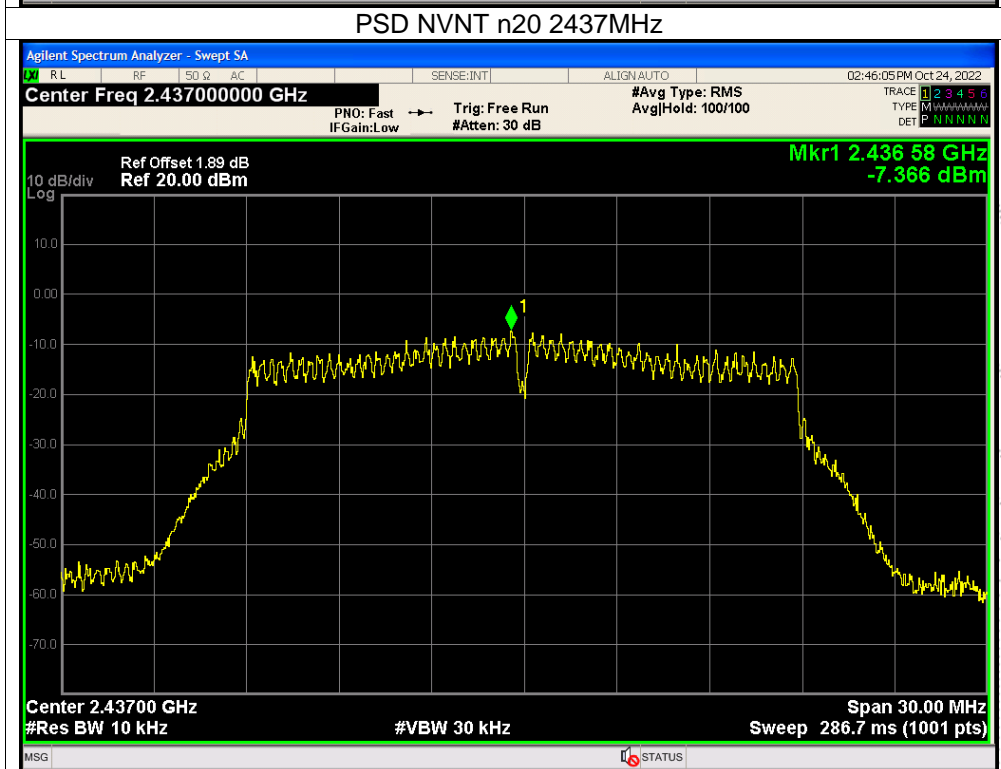
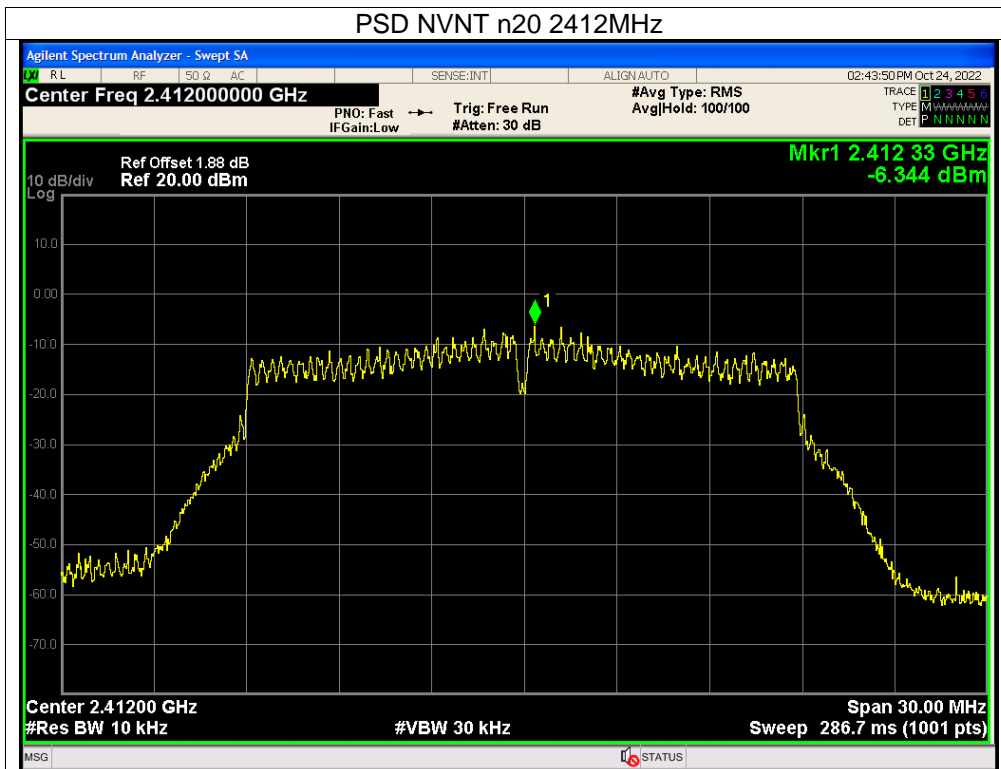

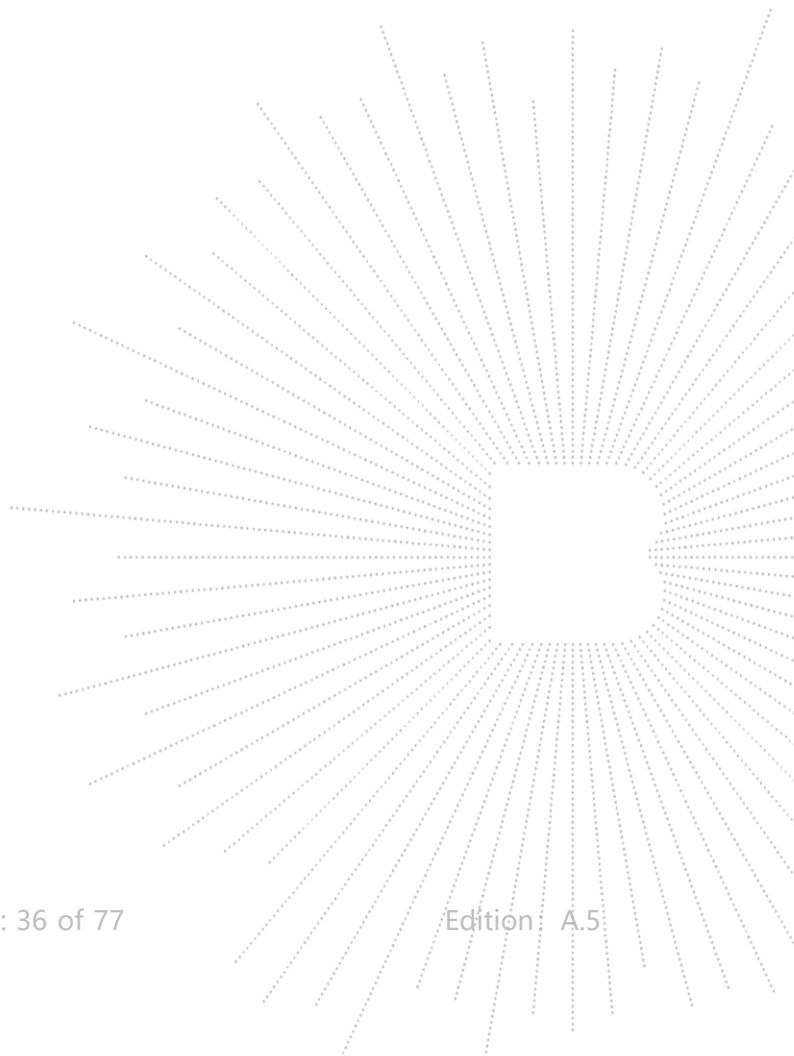
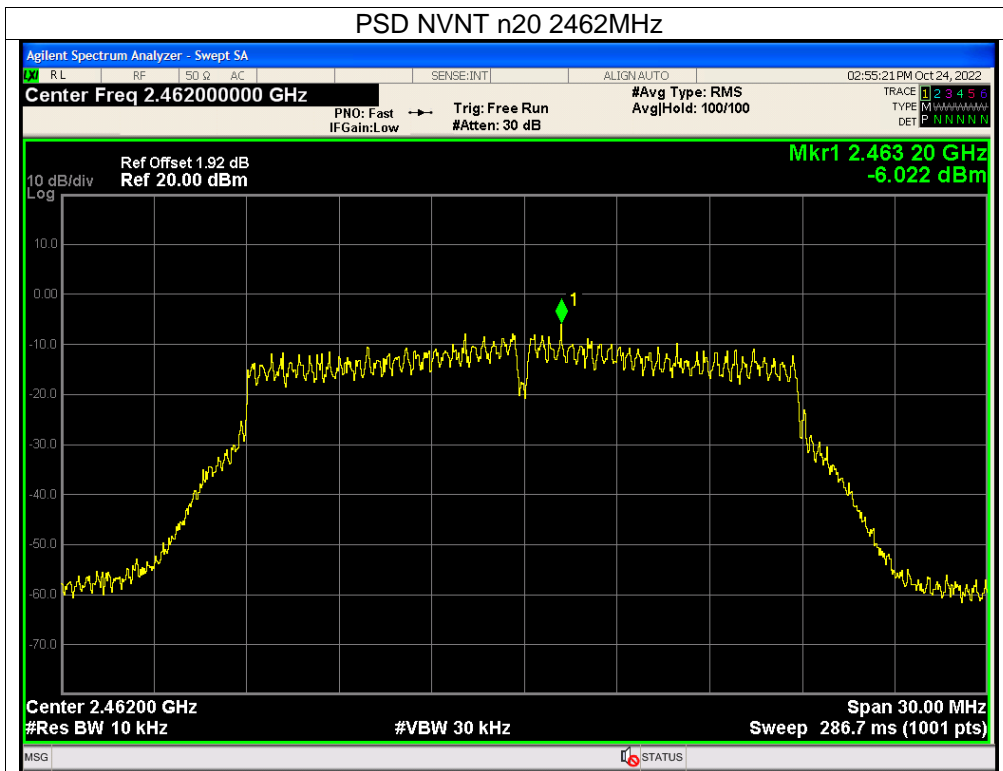

10. 99% & 6dB Bandwidth Test

10.1 Block Diagram Of Test Setup

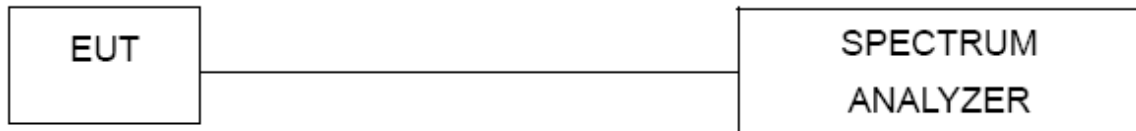

10.2 Limit

RSS-247 5.2				
Section	Test Item	Limit	Frequency Range(MHz)	Result
RSS-247.5.2(a) RSS-Gen.6.7	Bandwidth	$\geq 500\text{KHz}$ (6dB bandwidth)	2400-2483.5	PASS

10.3 Test Procedure

1. Set RBW = 100 kHz.
2. Set the video bandwidth (VBW) $\geq 3 \times$ RBW.
3. Detector = Peak.
4. Trace mode = max hold.
5. Sweep = auto couple.
6. Allow the trace to stabilize.
7. Measure the maximum width of the emission that is constrained by the frequencies associated with the two outermost amplitude points (upper and lower frequencies) that are attenuated by 6 dB relative to the maximum level measured in the fundamental emission.

The following procedure shall be used for measuring (99 %) power bandwidth:

1. Set center frequency to the nominal EUT channel center frequency.
2. Set span = 1.5 times to 5.0 times the OBW.
3. Set RBW = 1 % to 5 % of the OBW
4. Set VBW $\geq 3 \times$ RBW
5. Video averaging is not permitted. Where practical, a sample detection and single sweep mode shall be used. Otherwise, peak detection and max hold mode (until the trace stabilizes) shall be used.
6. Use the 99 % power bandwidth function of the instrument (if available).
7. If the instrument does not have a 99 % power bandwidth function, the trace data points are recovered and directly summed in power units. The recovered amplitude data points, beginning at the lowest frequency, are placed in a running sum until 0.5 % of the total is reached; that frequency is recorded as the lower frequency. The process is repeated until 99.5 % of the total is reached; that frequency is recorded as the upper frequency. The 99% occupied bandwidth is the difference between these two frequencies.

10.4 EUT Operating Conditions

The EUT tested system was configured as the statements of 2.4 Unless otherwise a special operating condition is specified in the follows during the testing.

10.5 Test Result

Temperature :	26°C	Relative Humidity :	54%
Pressure :	101kPa	Test Voltage :	DC 5V

Condition	Mode	Frequency (MHz)	-6 dB Bandwidth (MHz)	99% OBW (MHz)	Limit -6 dB Bandwidth (MHz)	Verdict
NVNT	b	2412	8.551	11.844	0.5	Pass
NVNT	b	2437	8.104	11.723	0.5	Pass
NVNT	b	2462	8.025	11.579	0.5	Pass
NVNT	g	2412	15.341	16.463	0.5	Pass
NVNT	g	2437	15.102	16.347	0.5	Pass
NVNT	g	2462	15.807	16.436	0.5	Pass
NVNT	n20	2412	16.66	17.606	0.5	Pass
NVNT	n20	2437	15.48	17.621	0.5	Pass
NVNT	n20	2462	15.921	17.583	0.5	Pass

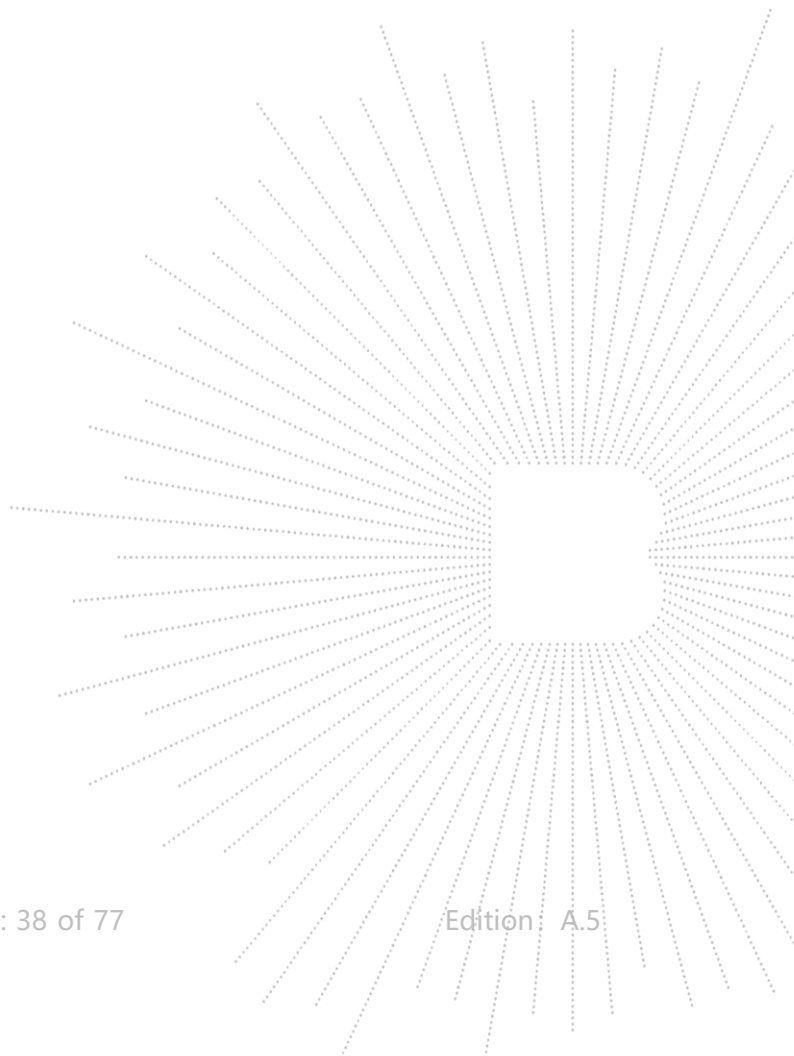

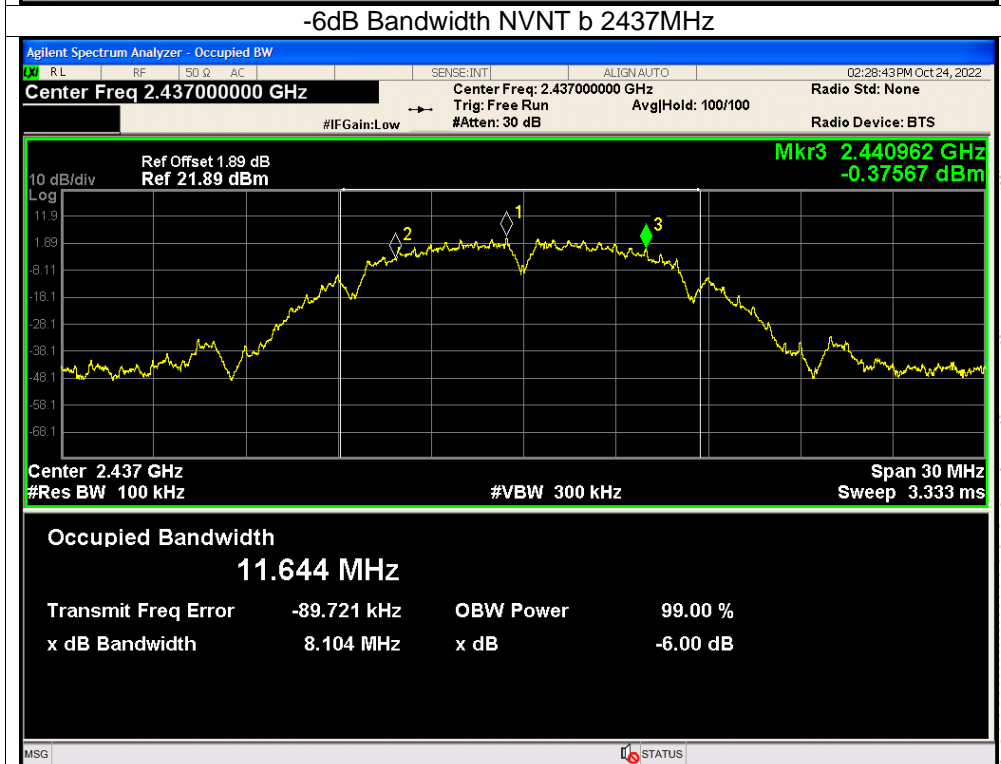
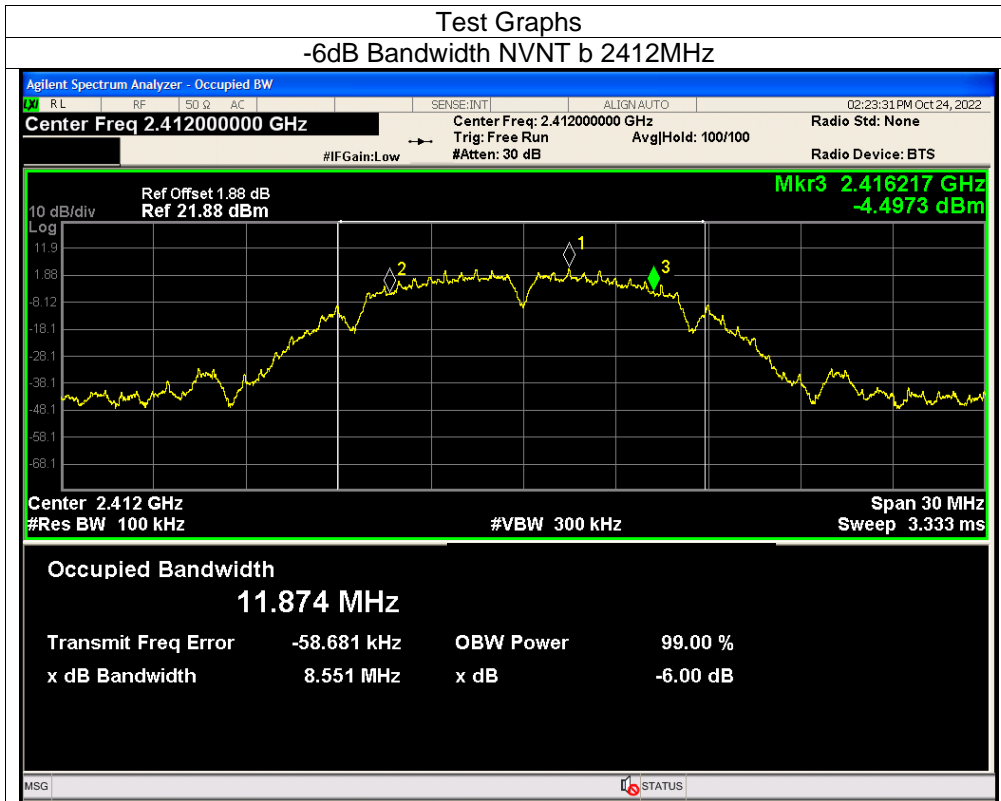

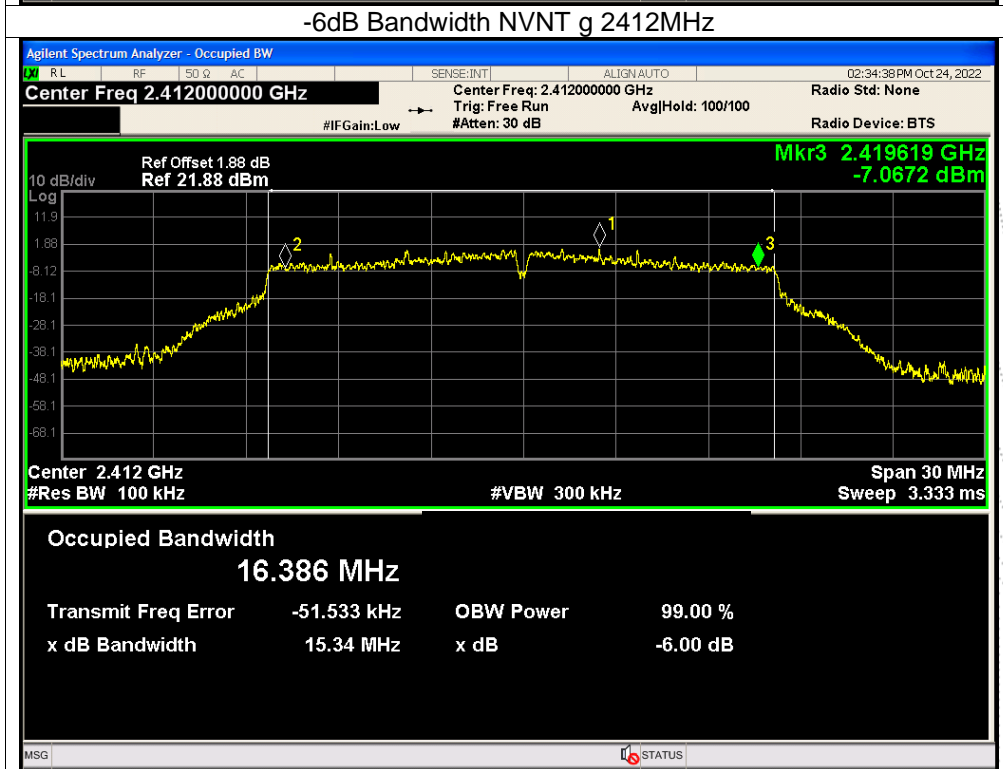
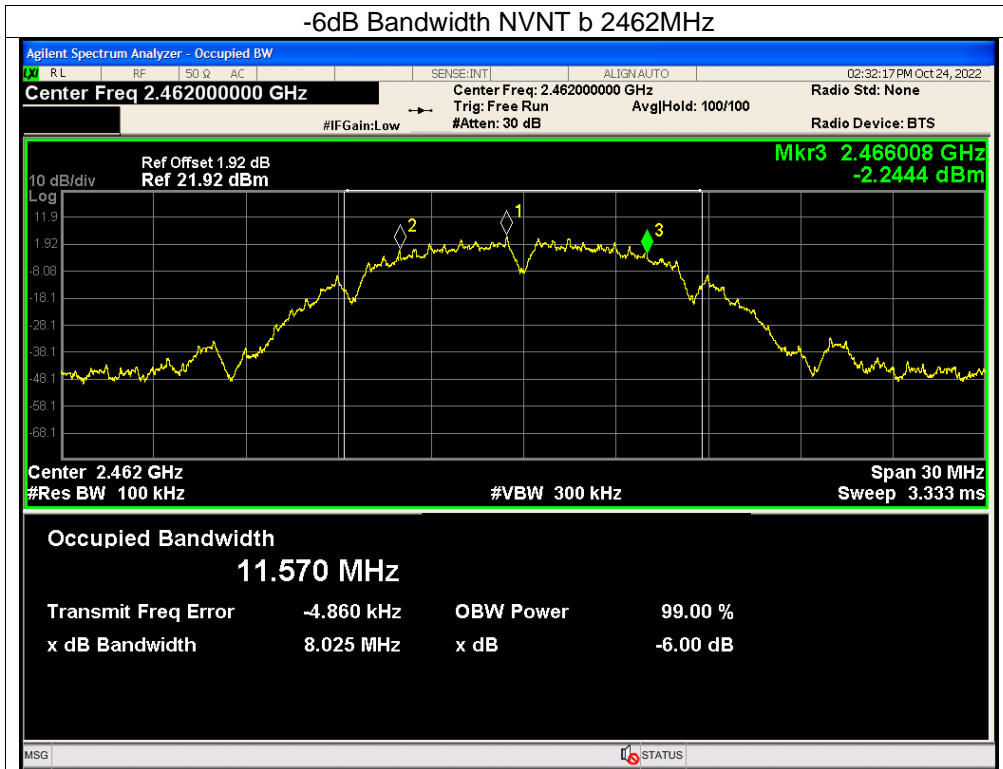

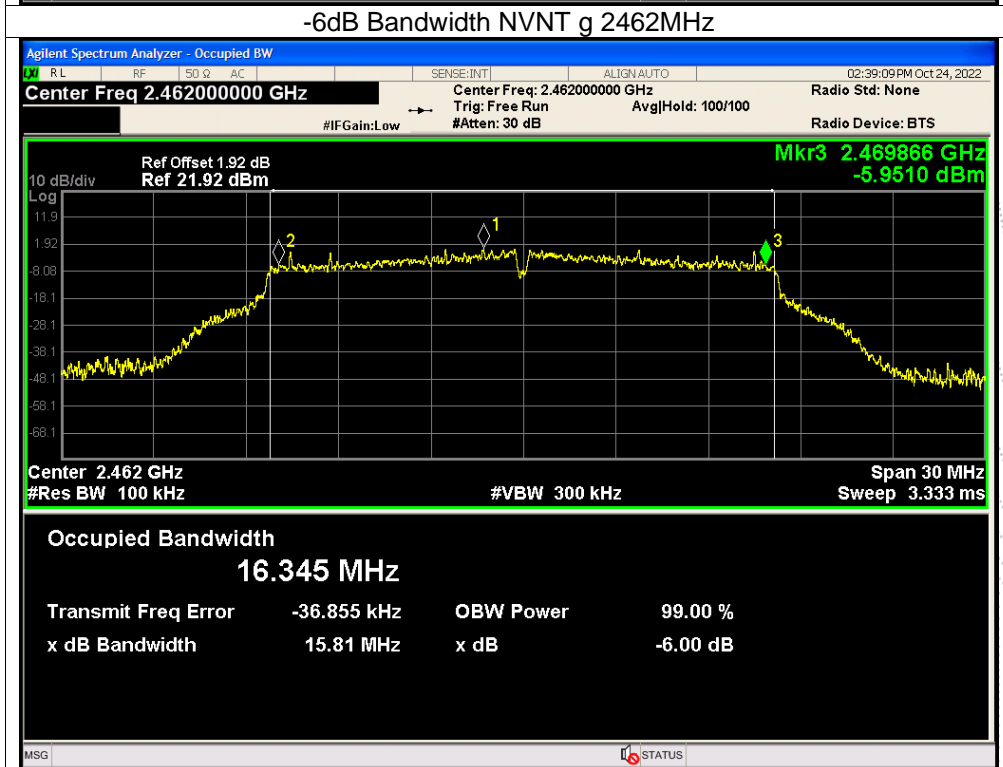
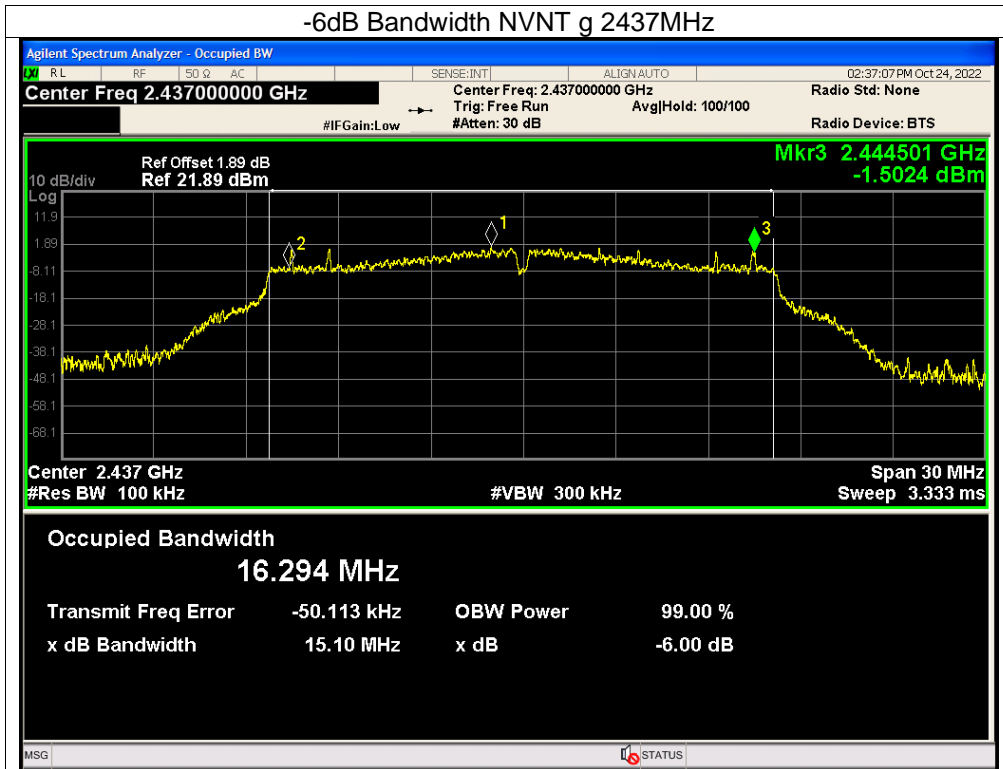

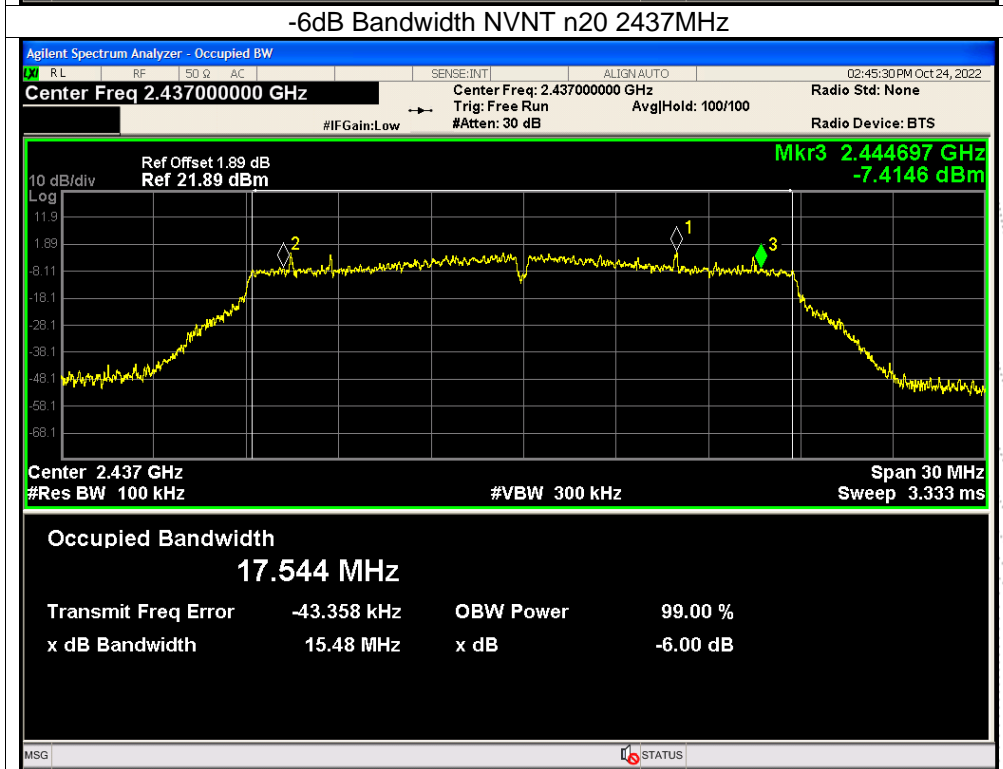
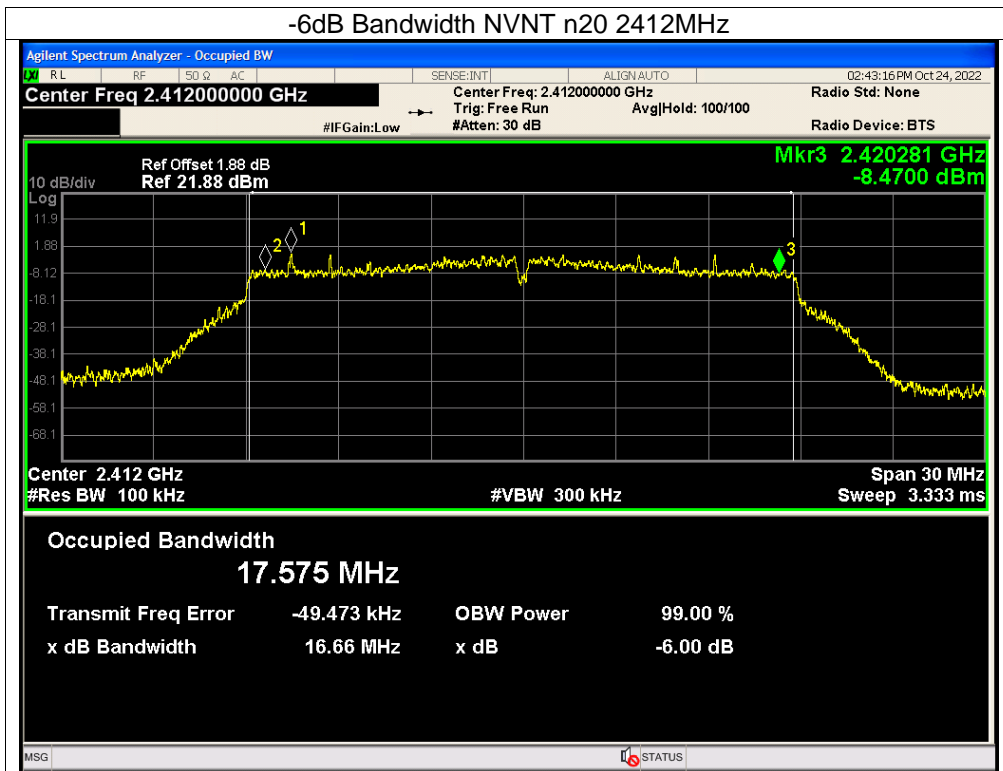

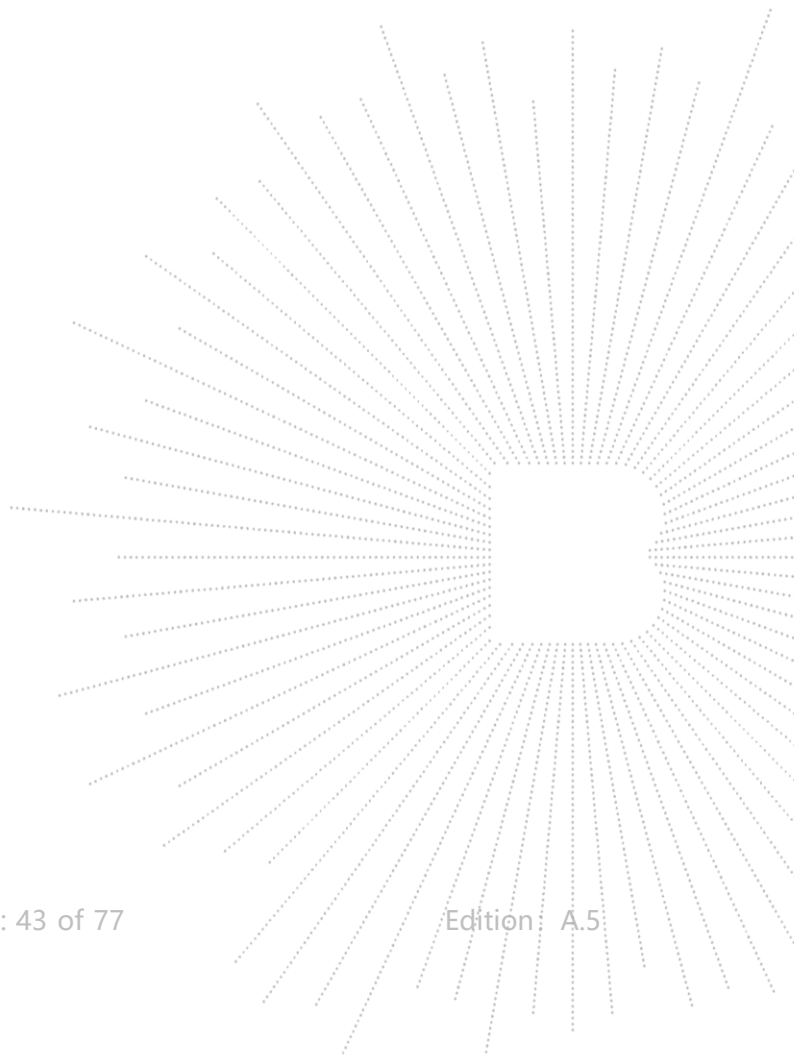
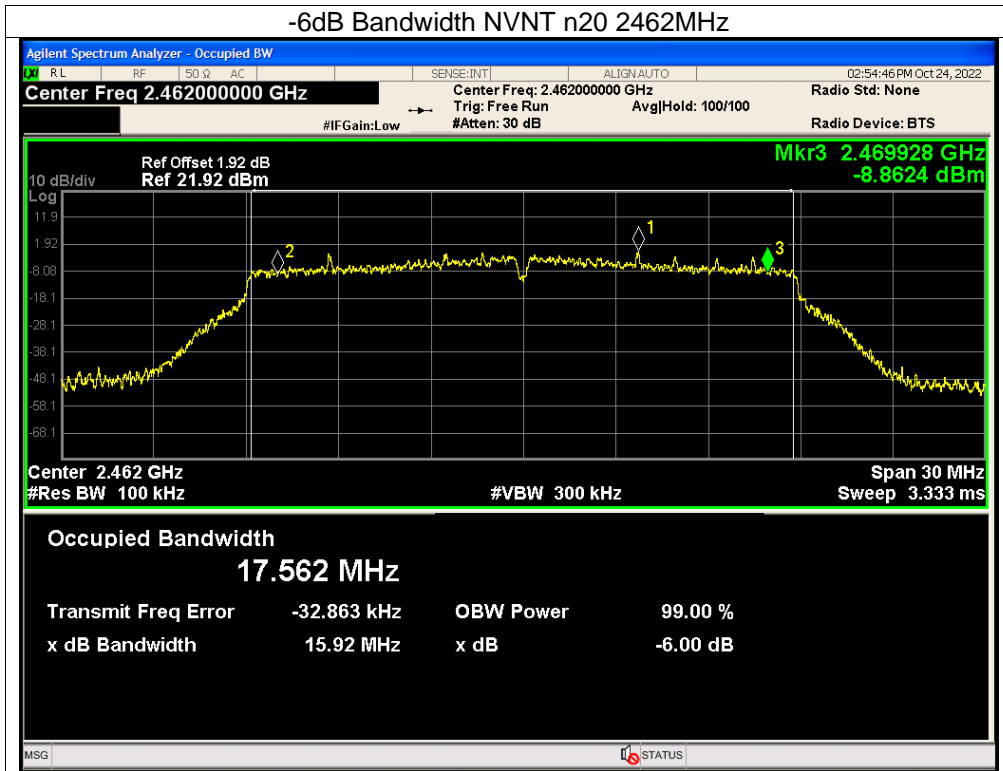

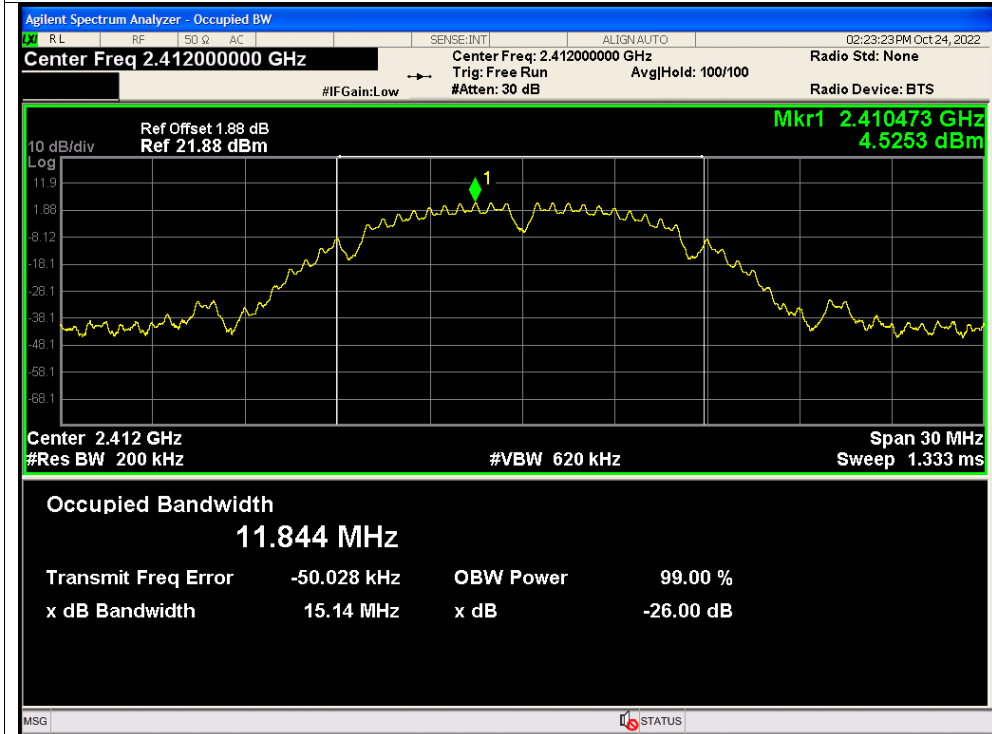
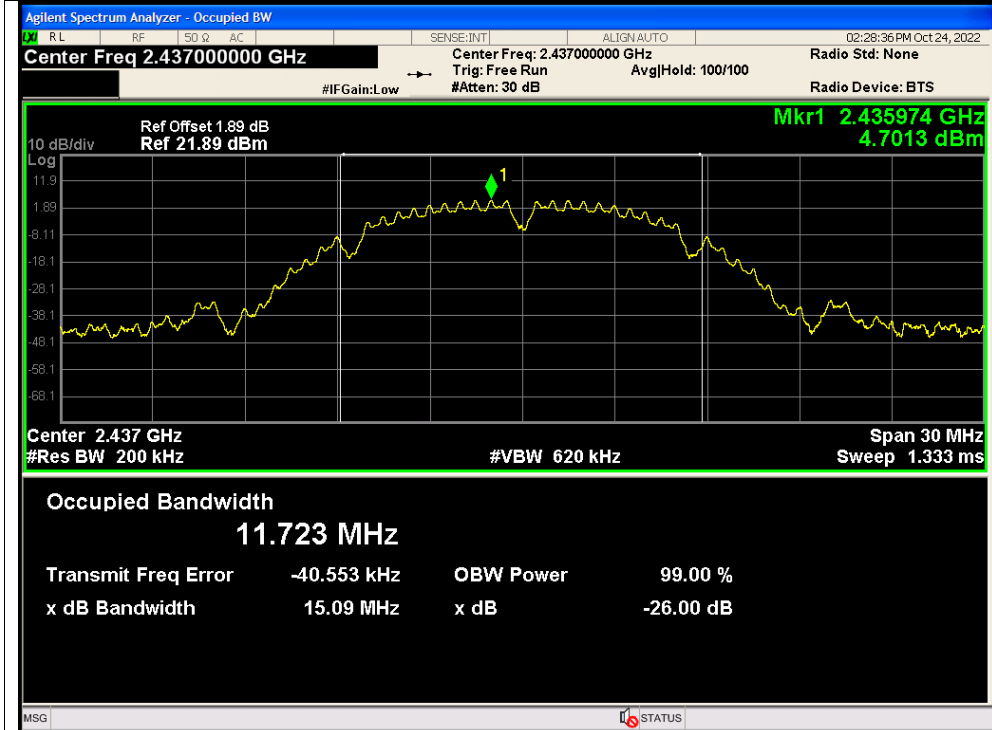
99% OBW
Test Graphs
OBW NVNT b 2412MHz

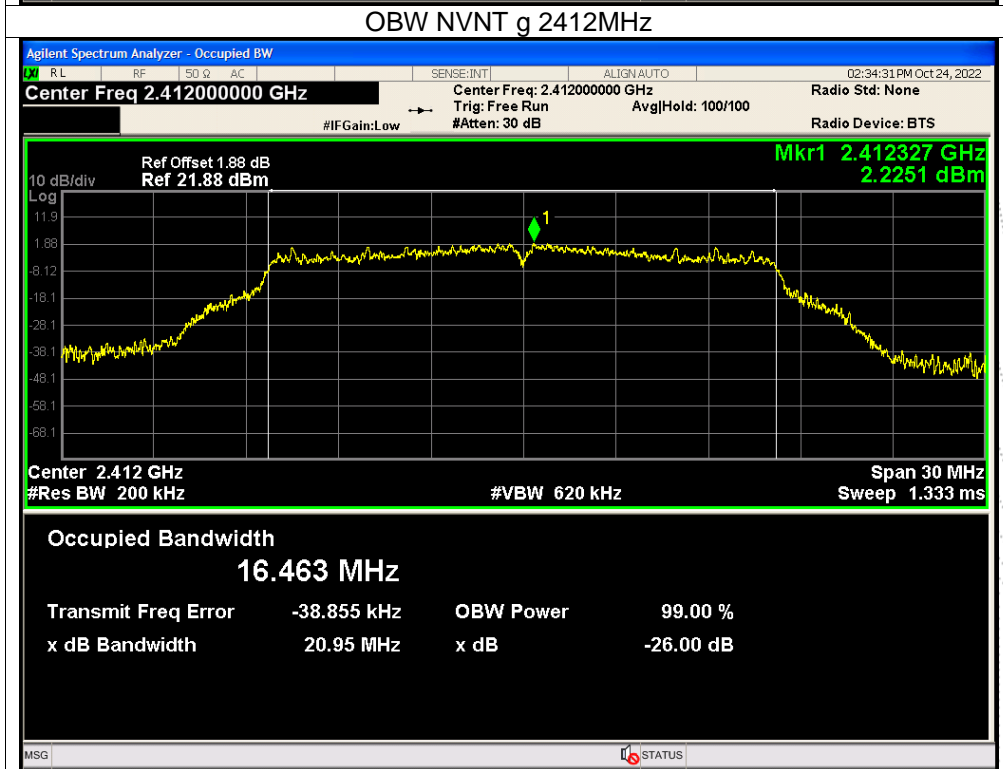
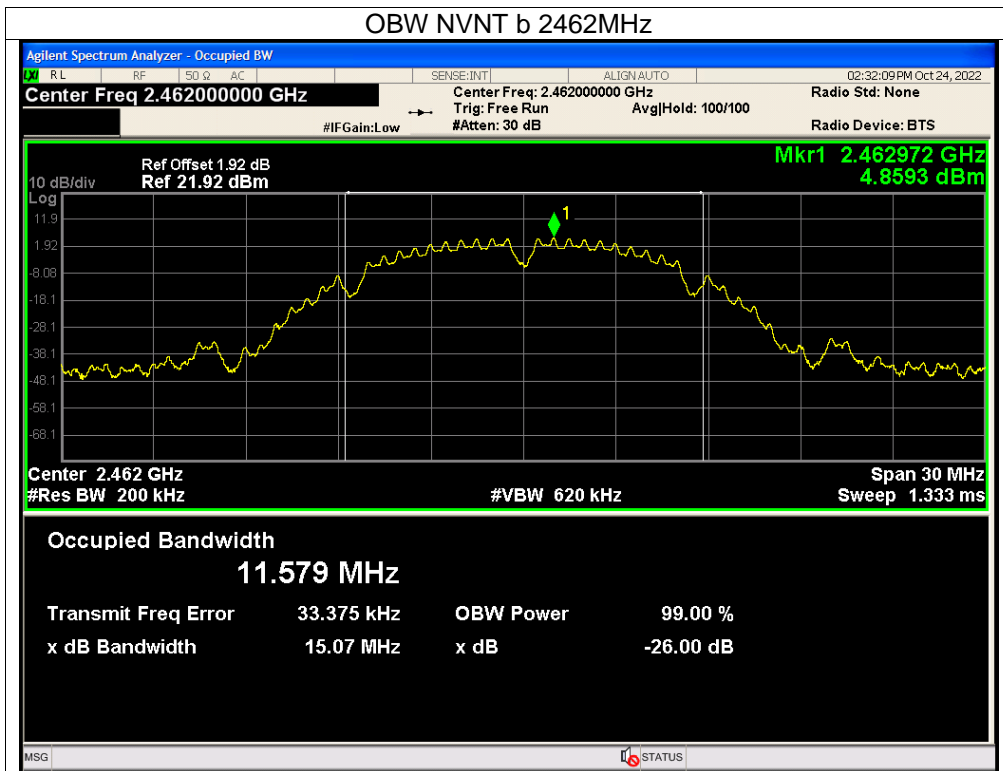
OBW NVNT b 2437MHz

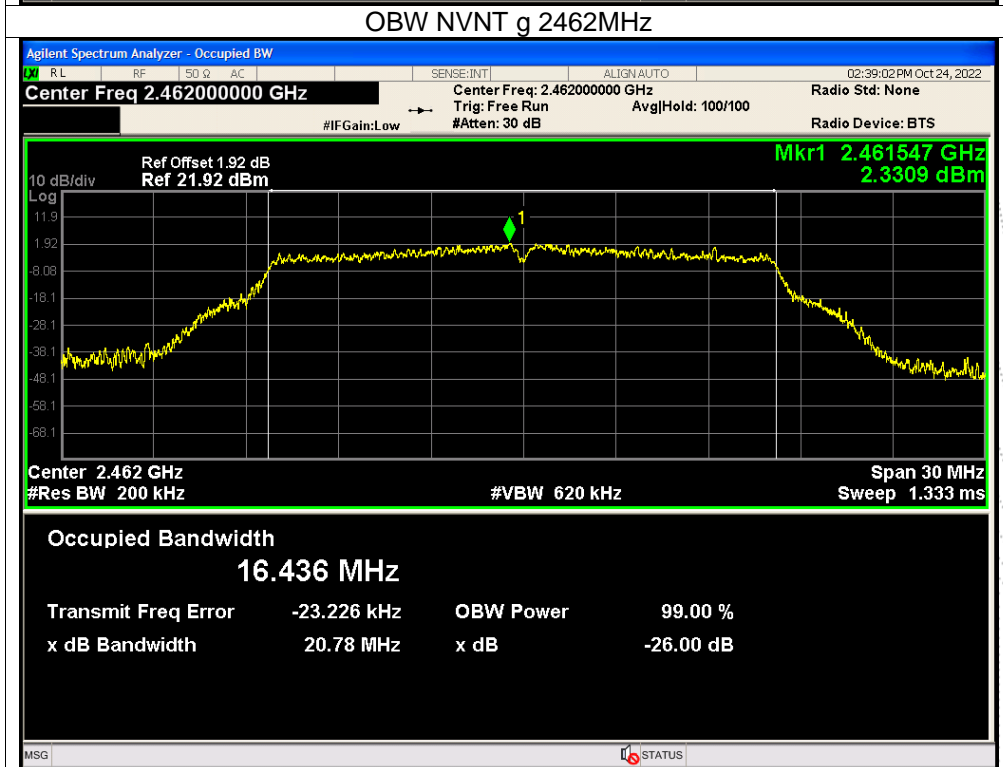
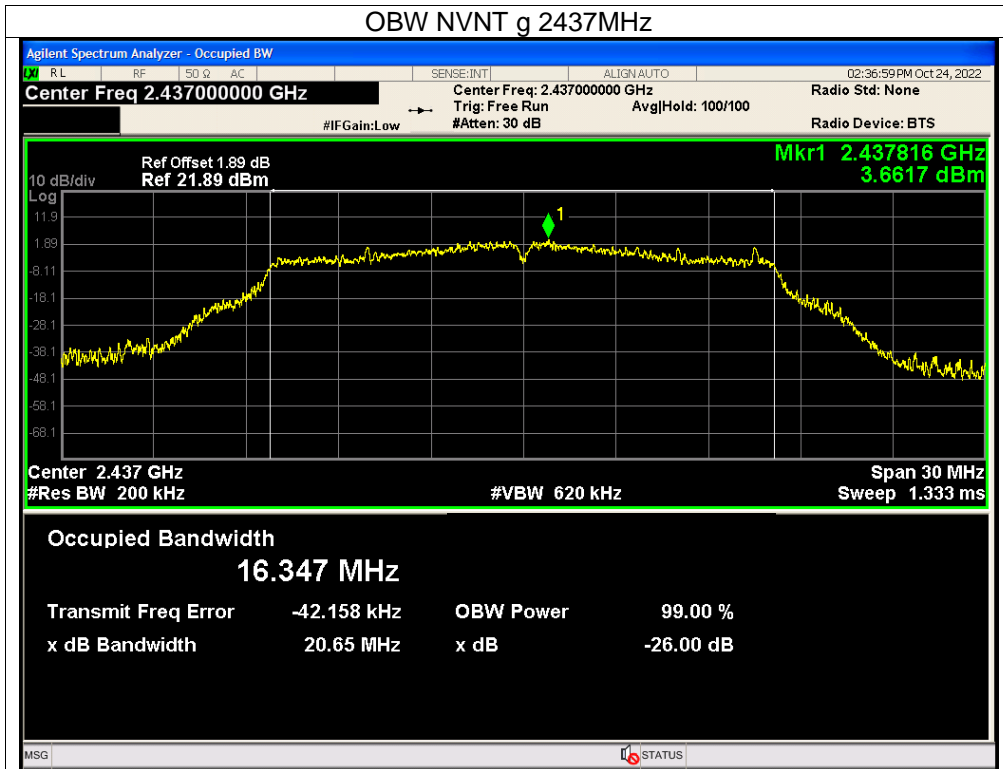

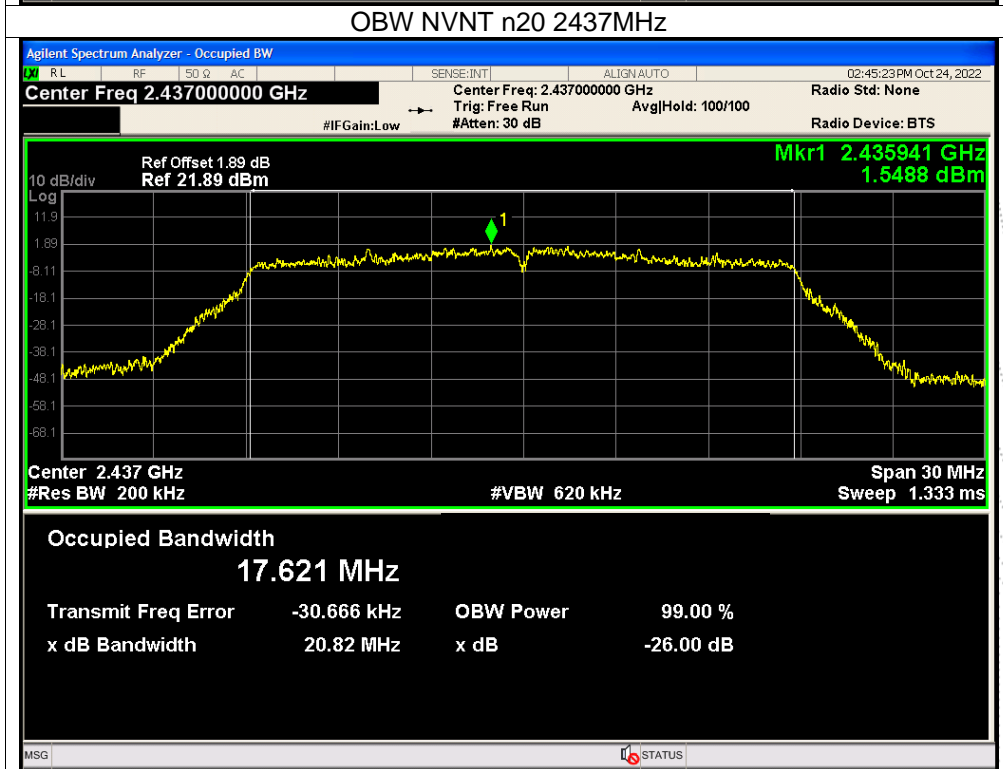
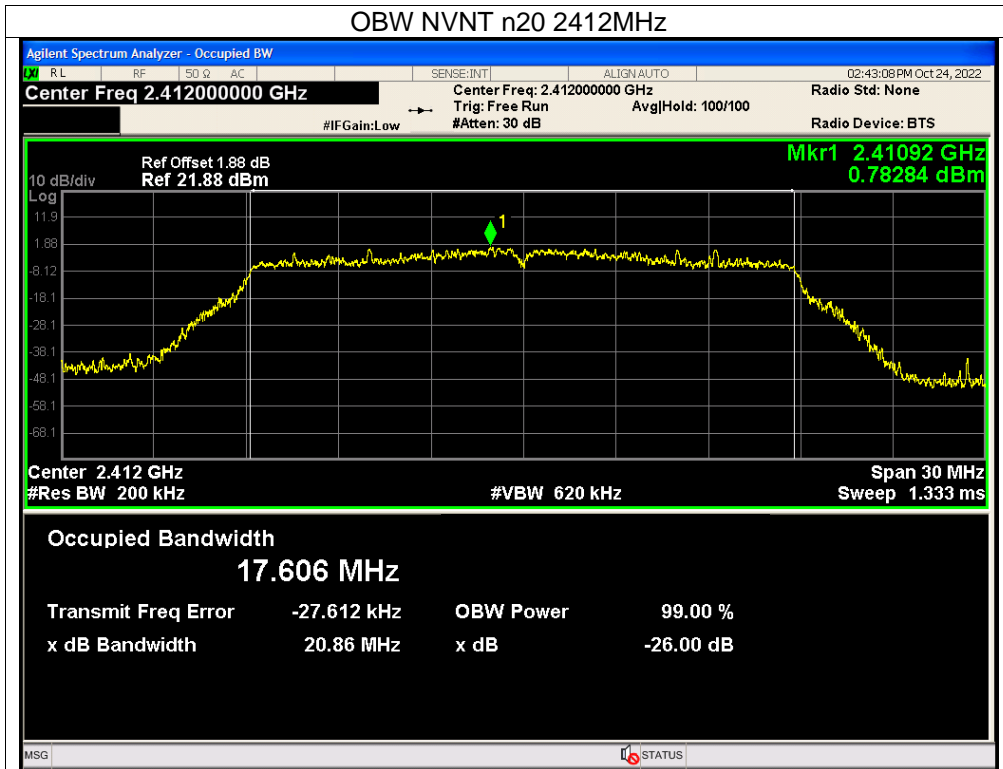

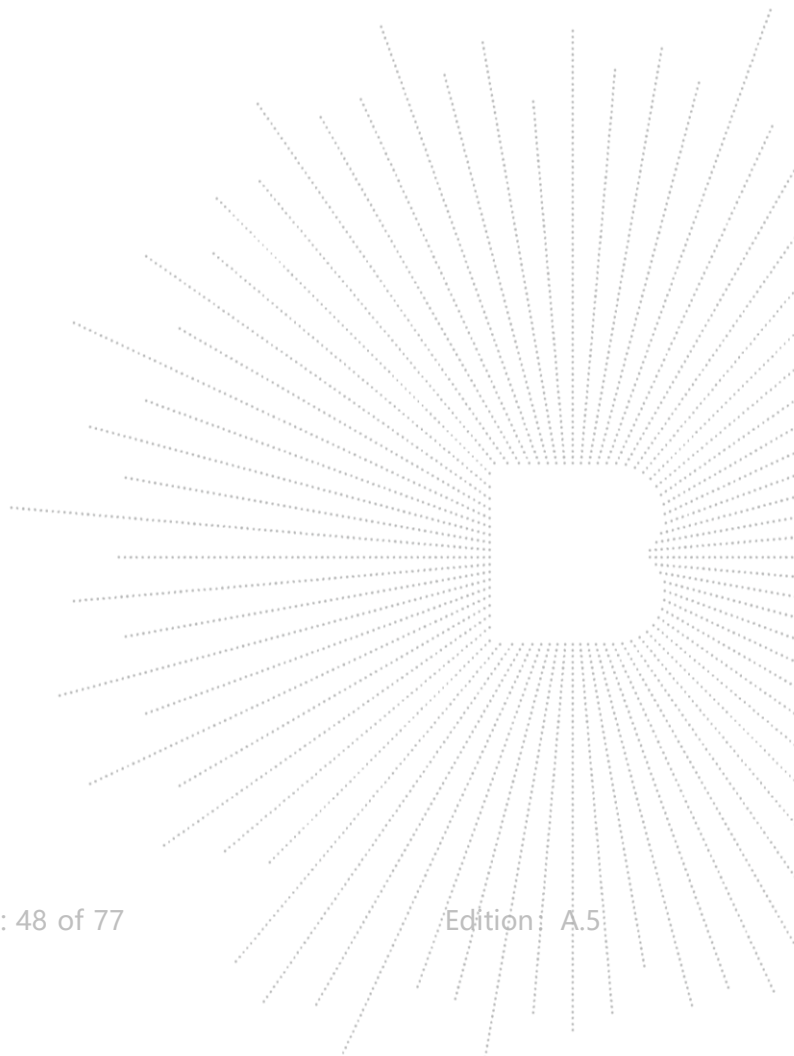
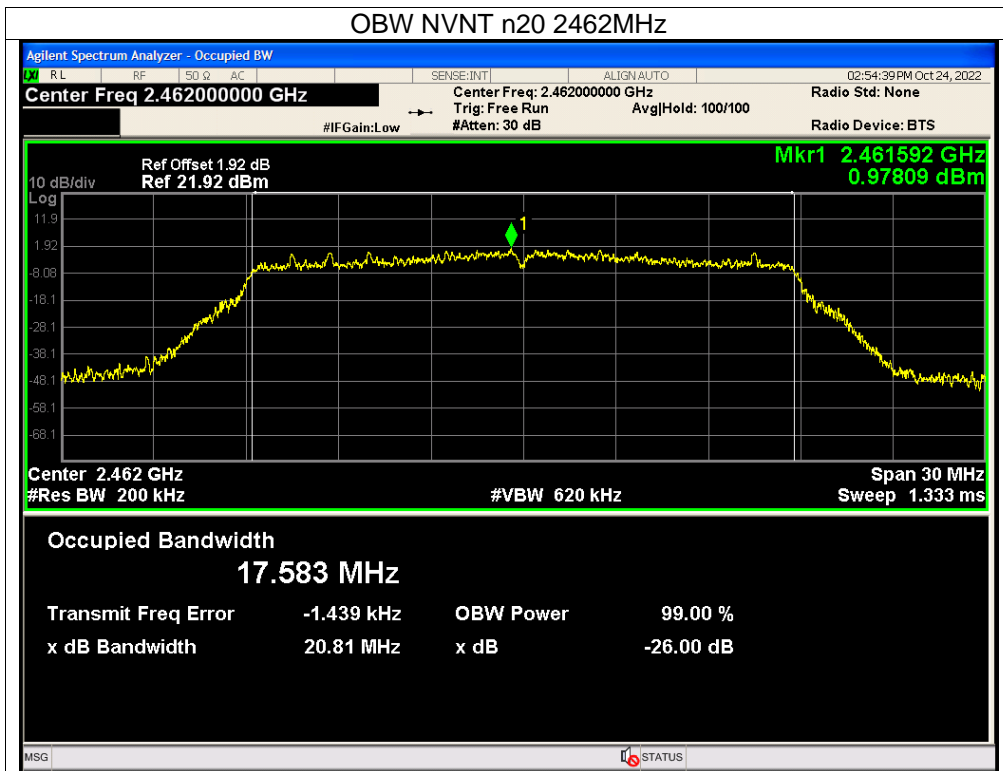



11. Peak Output Power Test

11.1 Block Diagram Of Test Setup



11.2 Limit

RSS-247 5.4 (b)				
Section	Test Item	Limit	Frequency Range (MHz)	Result
RSS-247 5.4 (b)	Peak Output Power	1 watt or 30dBm	2400-2483.5	PASS

11.3 Test Procedure

- a. The EUT was directly connected to the Power meter

11.4 EUT Operating Conditions

The EUT tested system was configured as the statements of 2.4 Unless otherwise a special operating condition is specified in the follows during the testing.

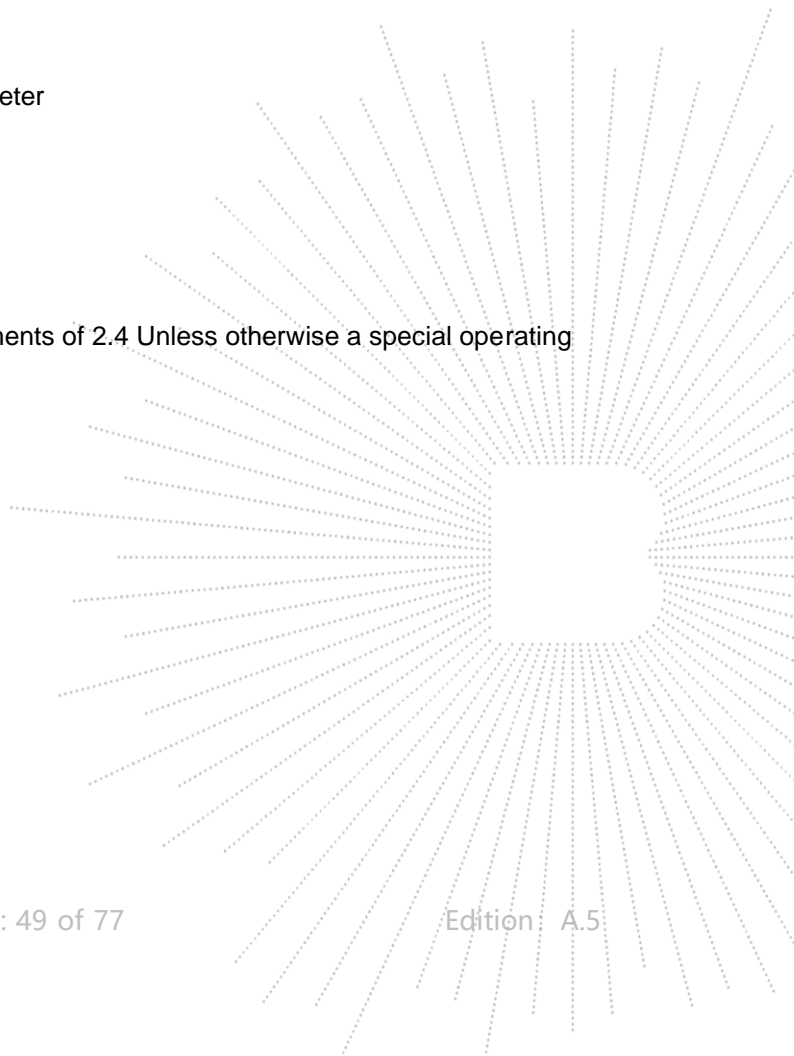

11.5 Test Result

Temperature :	26°C	Relative Humidity :	54%
Pressure :	101kPa	Test Voltage :	DC 5V

Condition	Mode	Frequency (MHz)	Conducted Power (dBm)	Limit (dBm)	EIRP (dBm)	EIRP LIMIT (dBm)
NVNT	b	2412	12.86	30	5.63	36
NVNT	b	2437	13.02	30	5.79	36
NVNT	b	2462	13	30	5.77	36
NVNT	g	2412	11.67	30	4.44	36
NVNT	g	2437	11.83	30	4.6	36
NVNT	g	2462	11.77	30	4.54	36
NVNT	n20	2412	10.04	30	2.81	36
NVNT	n20	2437	10.46	30	3.23	36
NVNT	n20	2462	10.25	30	3.02	36

Note: 1. EIRP= Output Power+Antenna Gain.
 2. Antenna Gain=-7.23 dBi.

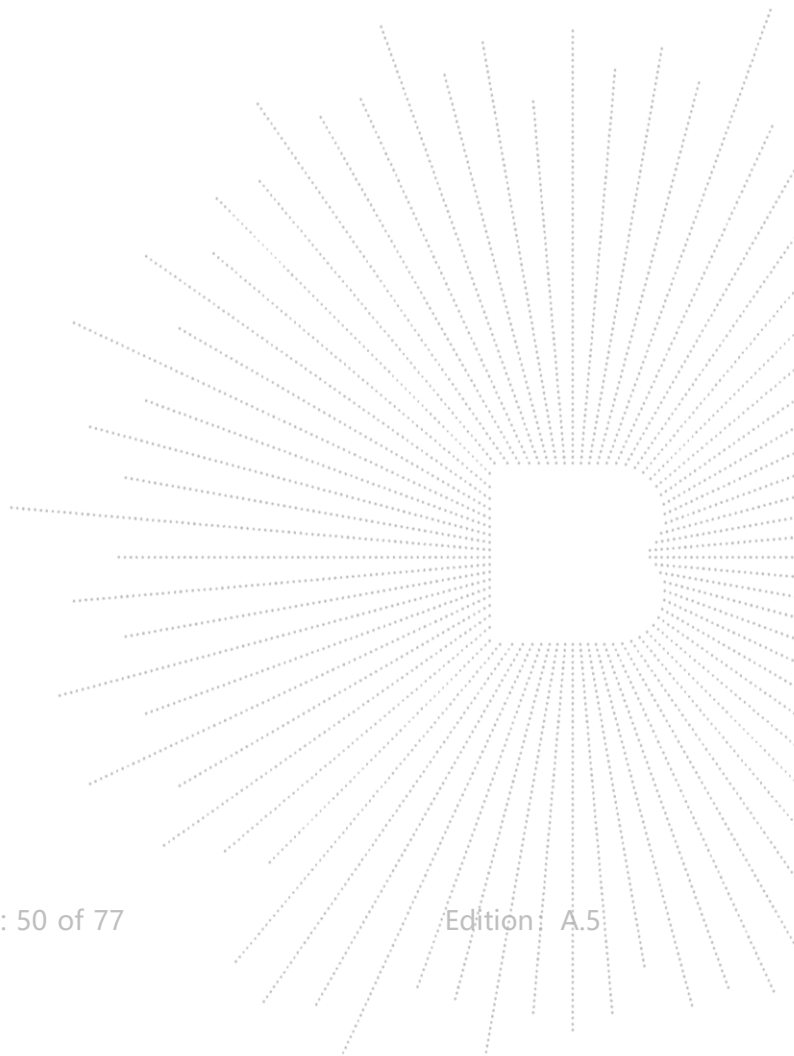

12. 100 KHz Bandwidth Of Frequency Band Edge

12.1 Block Diagram Of Test Setup

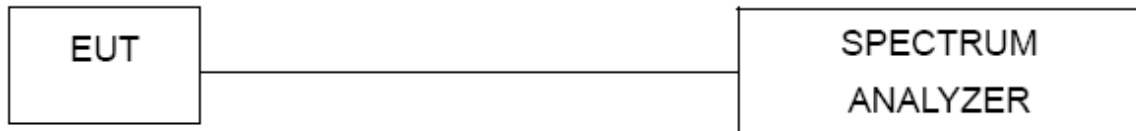

12.2 Limit

In any 100 kHz bandwidth outside the frequency band in which the spread spectrum or digitally modulated device is operating, the RF power that is produced shall be at least 20 dB below that in the 100 kHz bandwidth within the band that contains the highest level of the desired power, based on either an RF conducted or a radiated measurement, provided that the transmitter demonstrates compliance with the peak conducted power limits. If the transmitter complies with the conducted power limits based on the use of root-mean-square averaging over a time interval, as permitted under section RSS-247 5.4(d), the attenuation required shall be 30 dB instead of 20 dB. Attenuation below the general field strength limits specified in RSS-Gen is not required.

12.3 Test Procedure

Using the following spectrum analyzer setting:

- Set the RBW = 100KHz.
- Set the VBW = 300KHz.
- Sweep time = auto couple.
- Detector function = peak.
- Trace mode = max hold.
- Allow trace to fully stabilize..

12.4 EUT Operating Conditions

The EUT tested system was configured as the statements of 2.4 Unless otherwise a special operating condition is specified in the follows during the testing.

12.5 Test Result

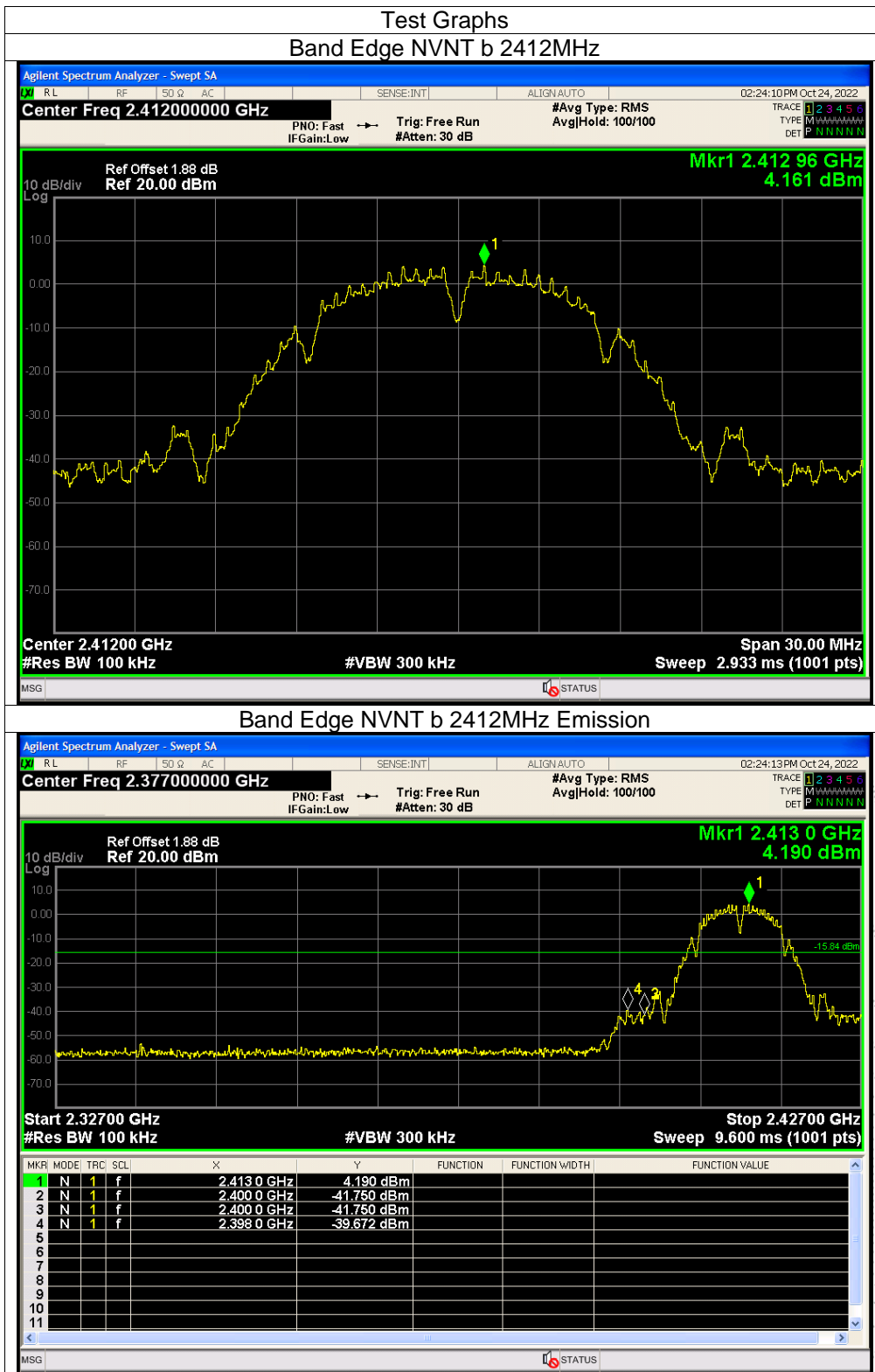

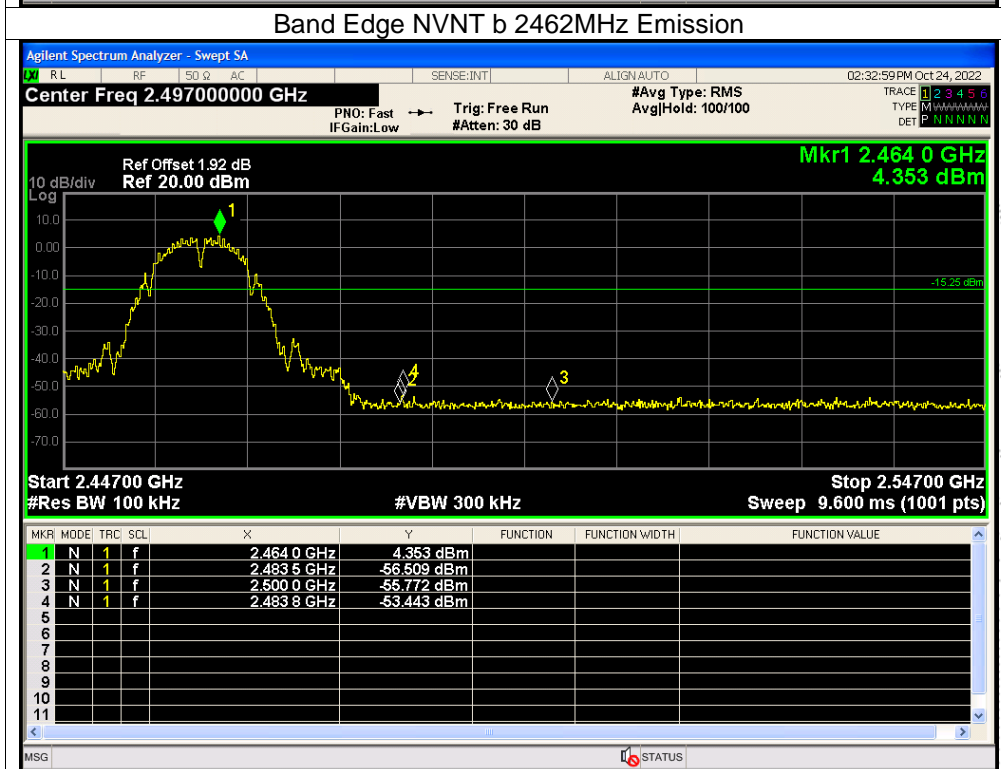
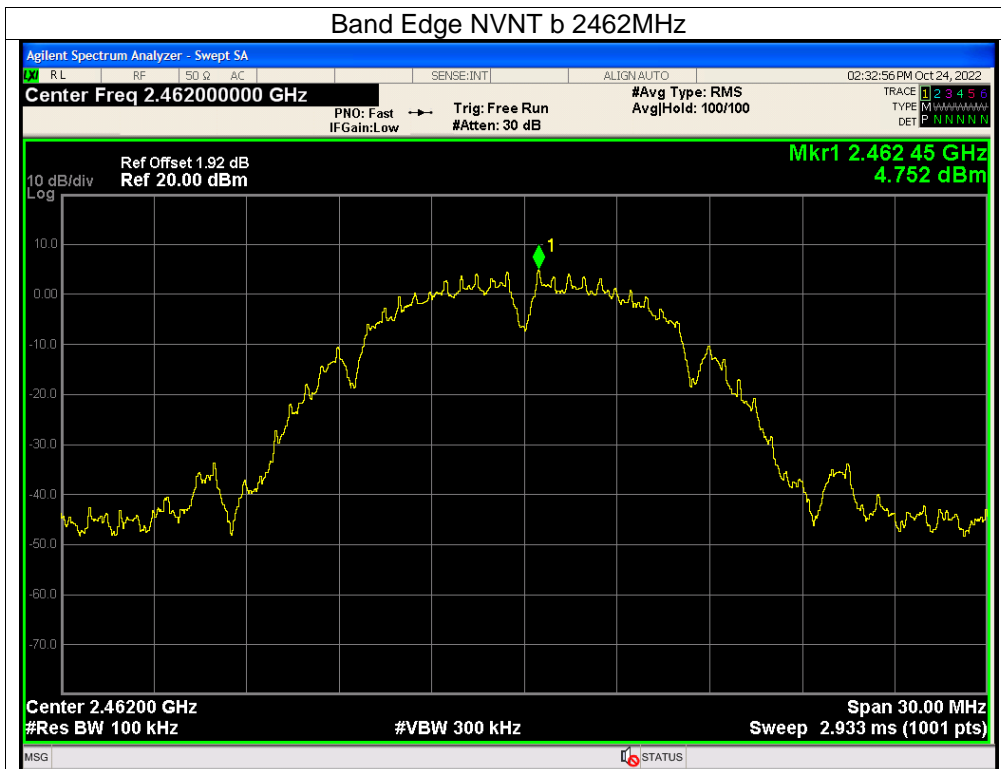

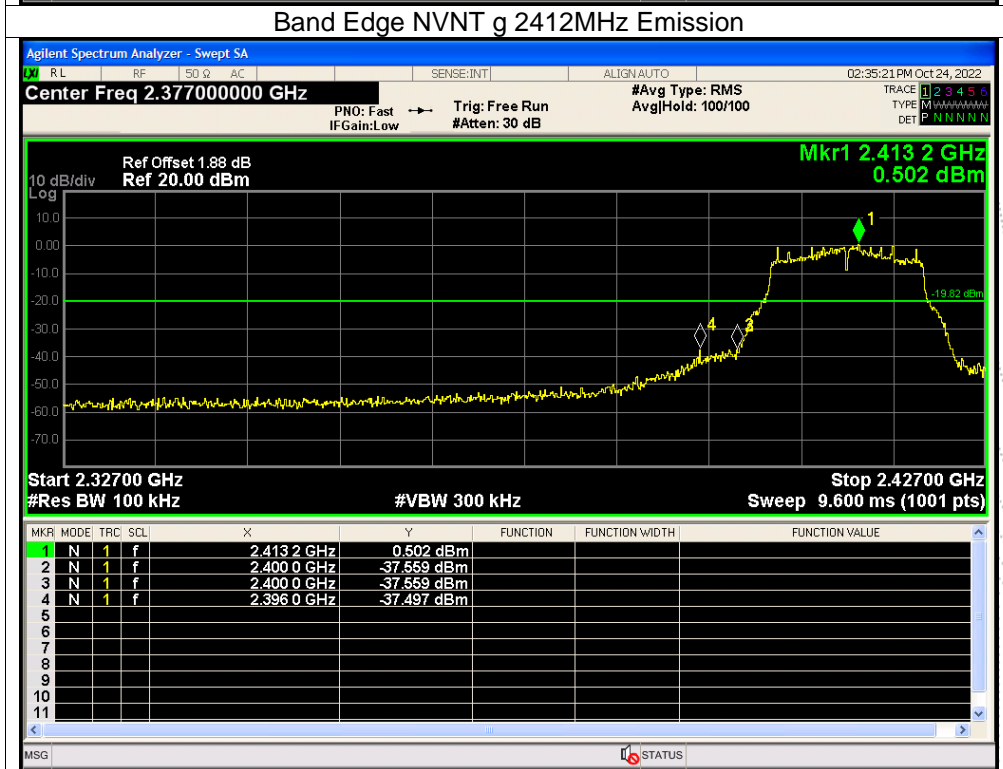
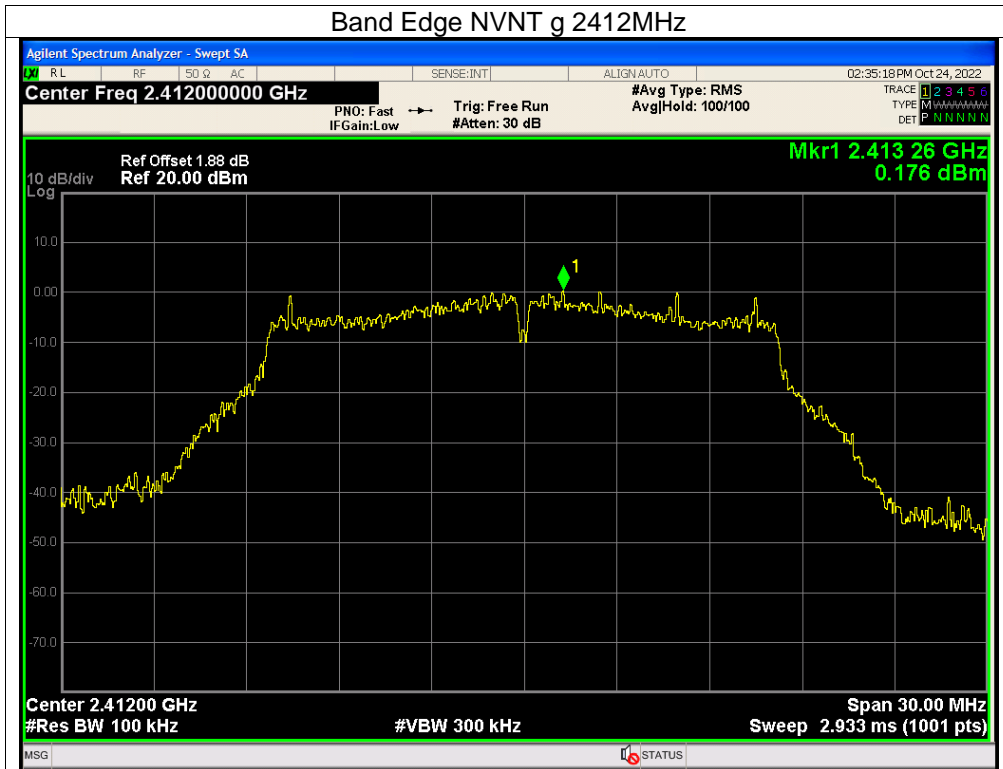

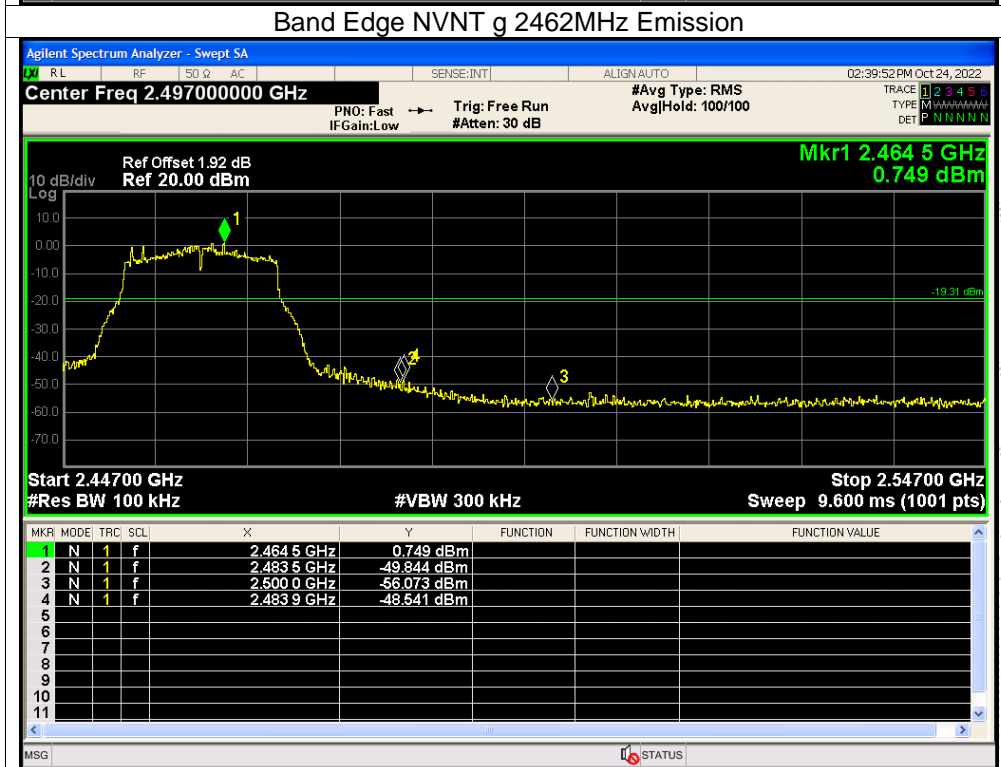
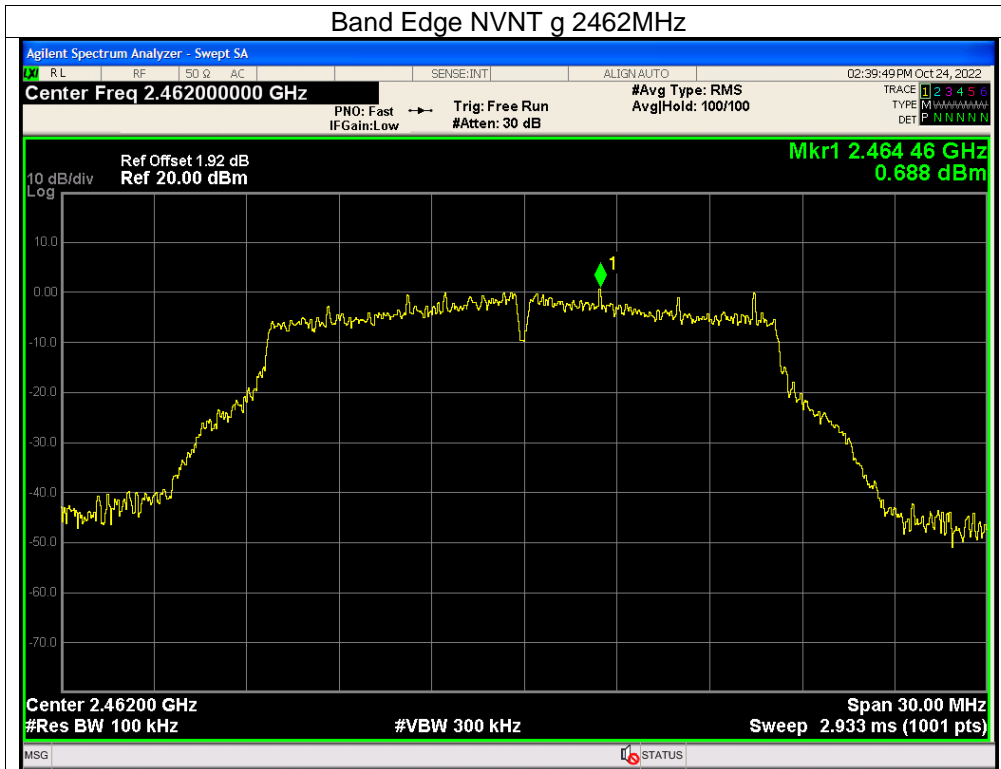

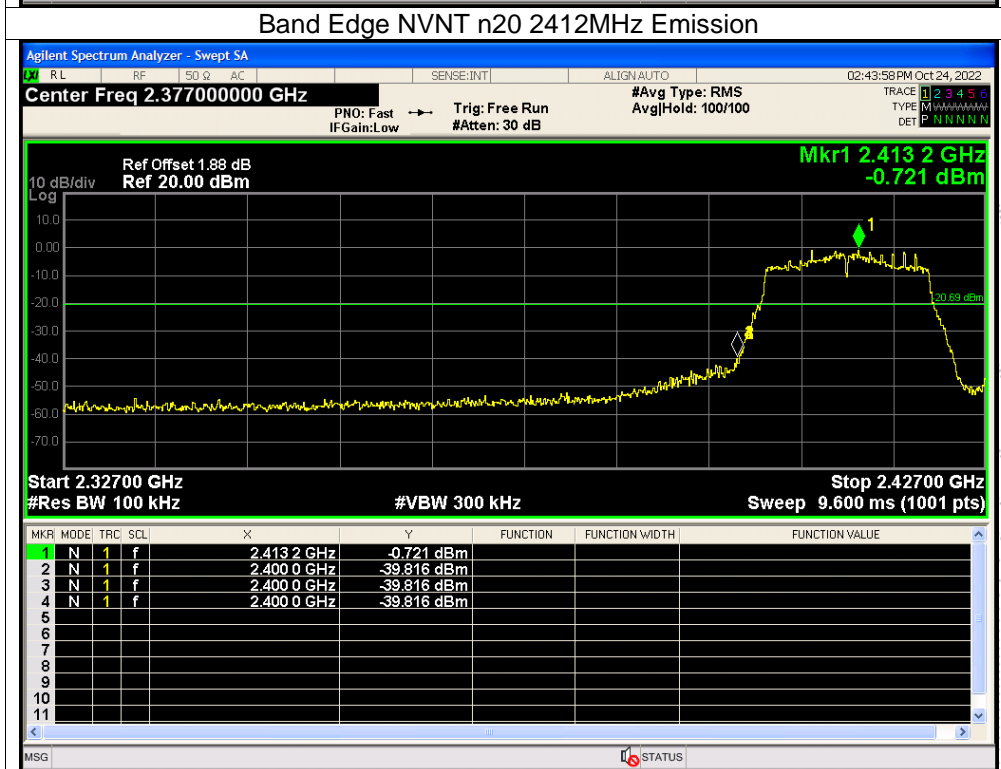
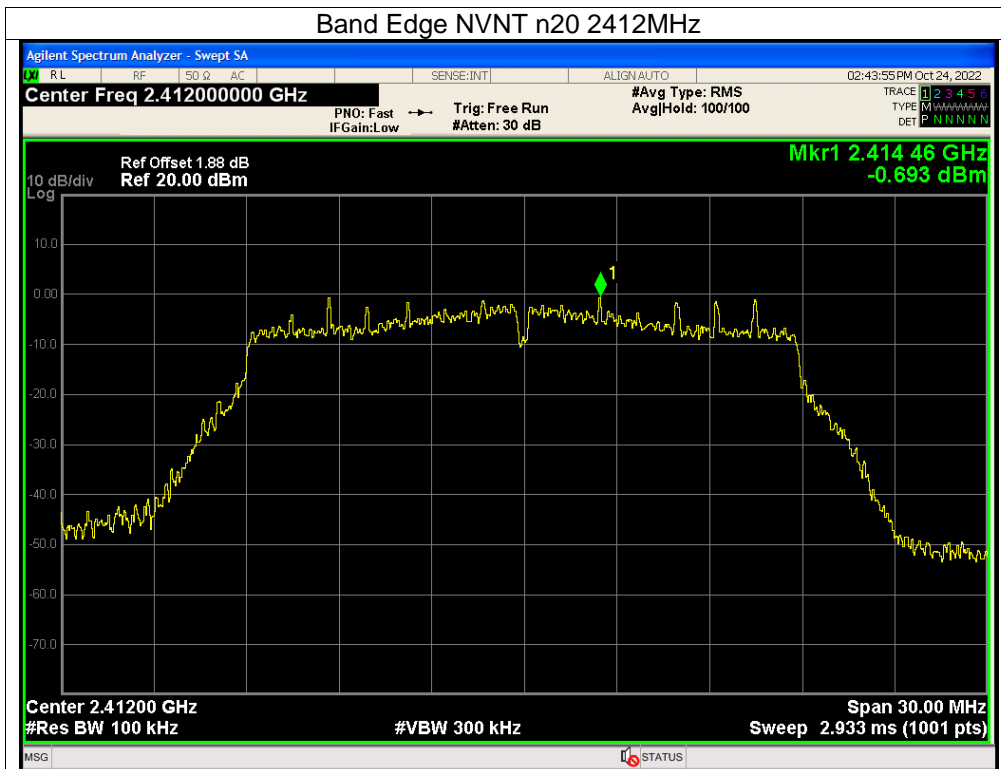

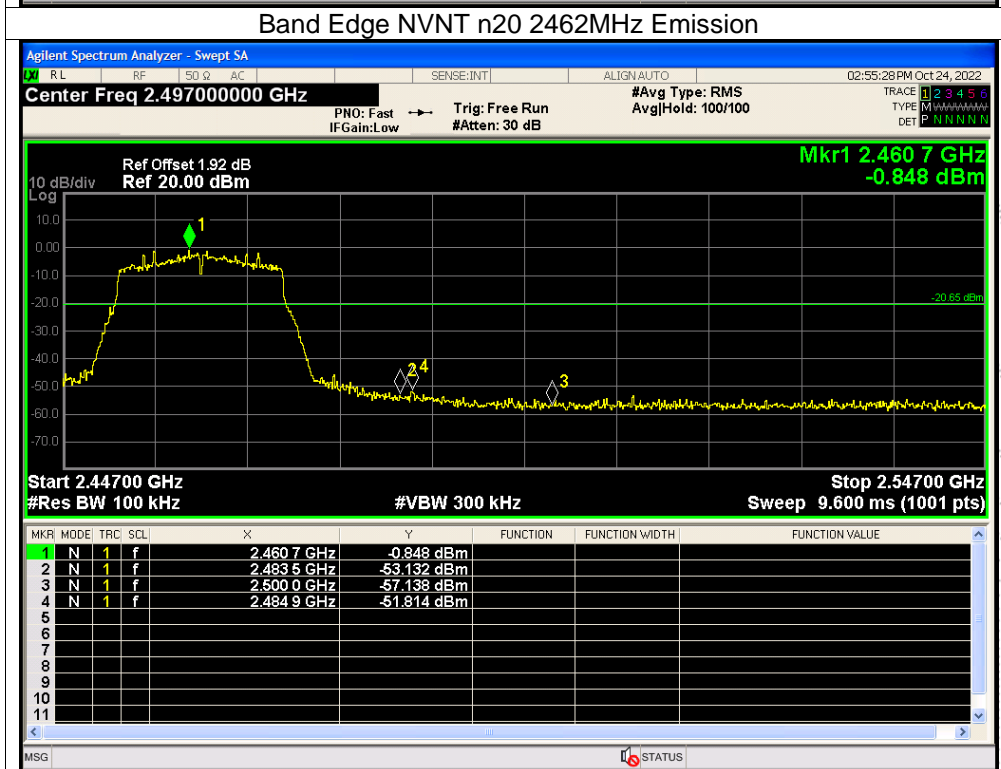
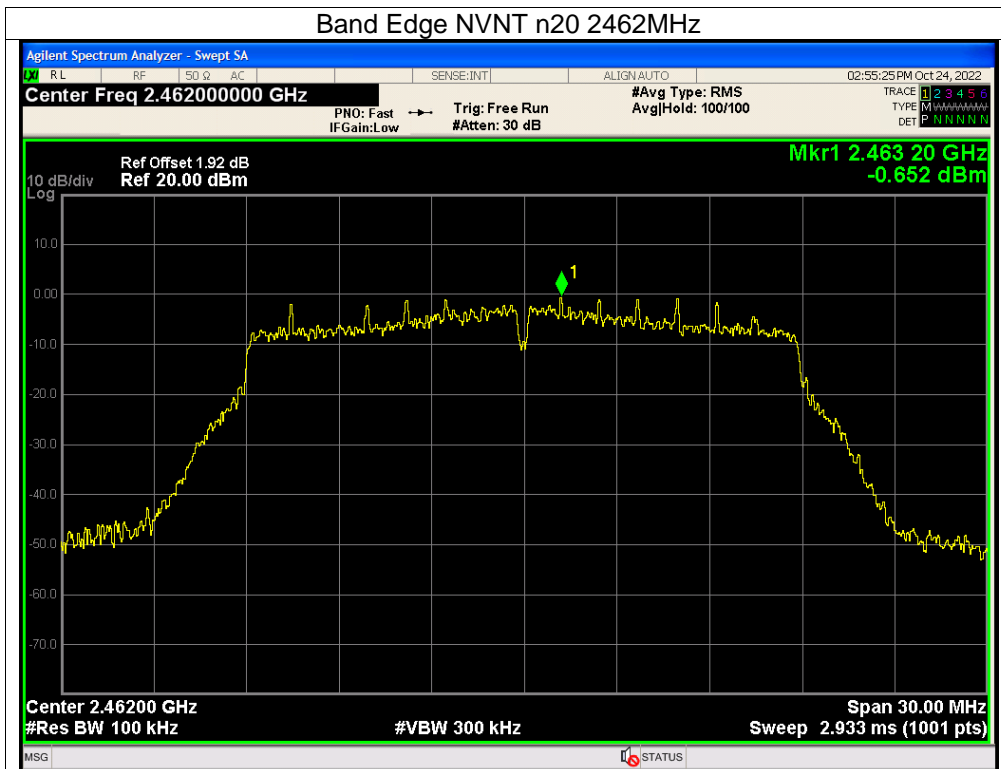

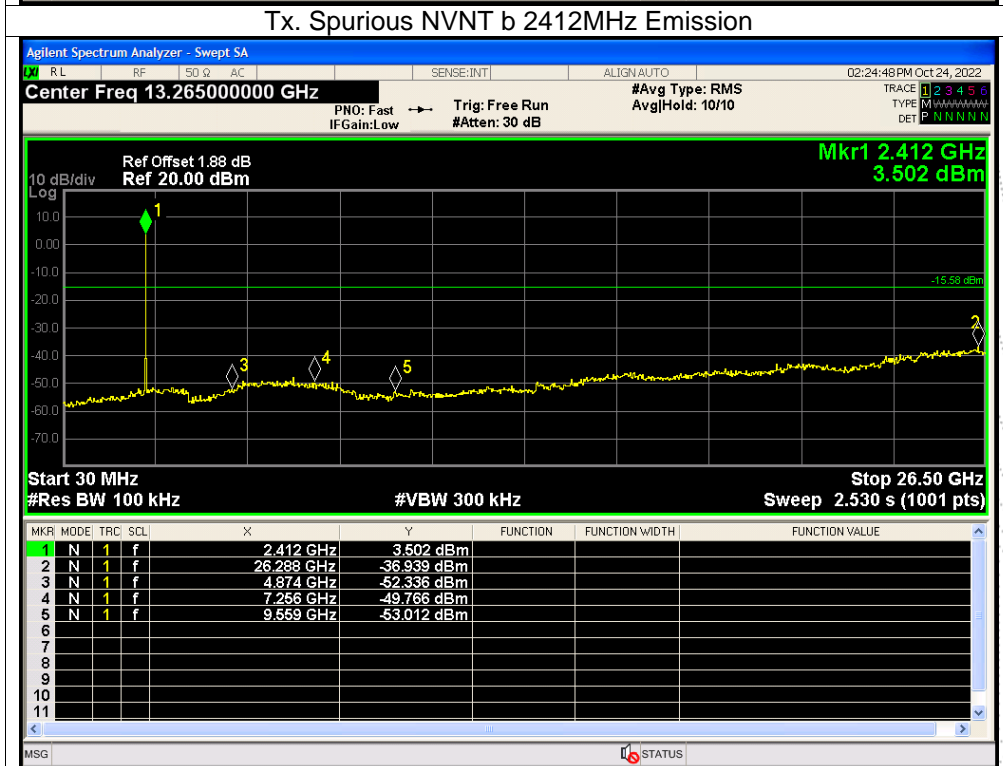

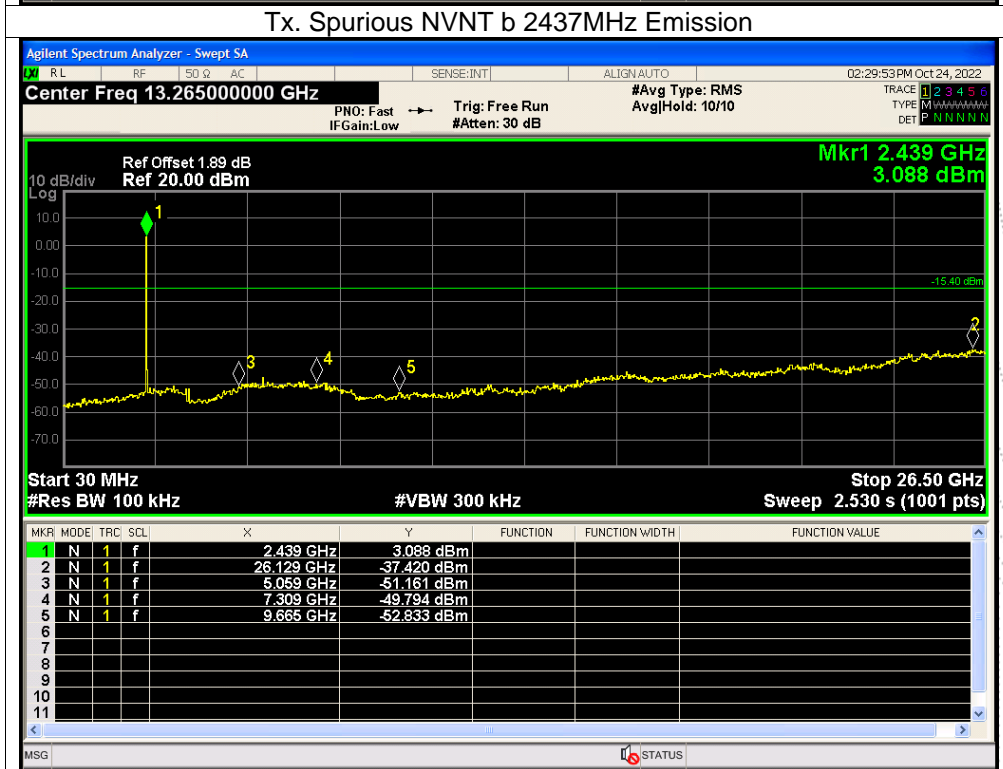
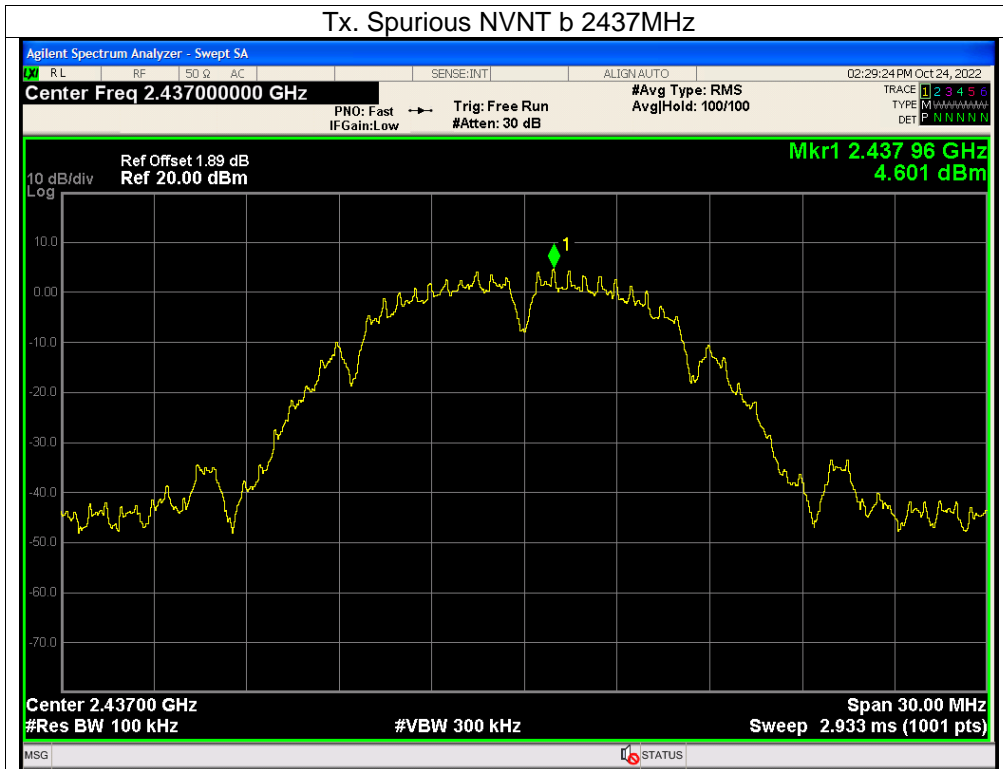

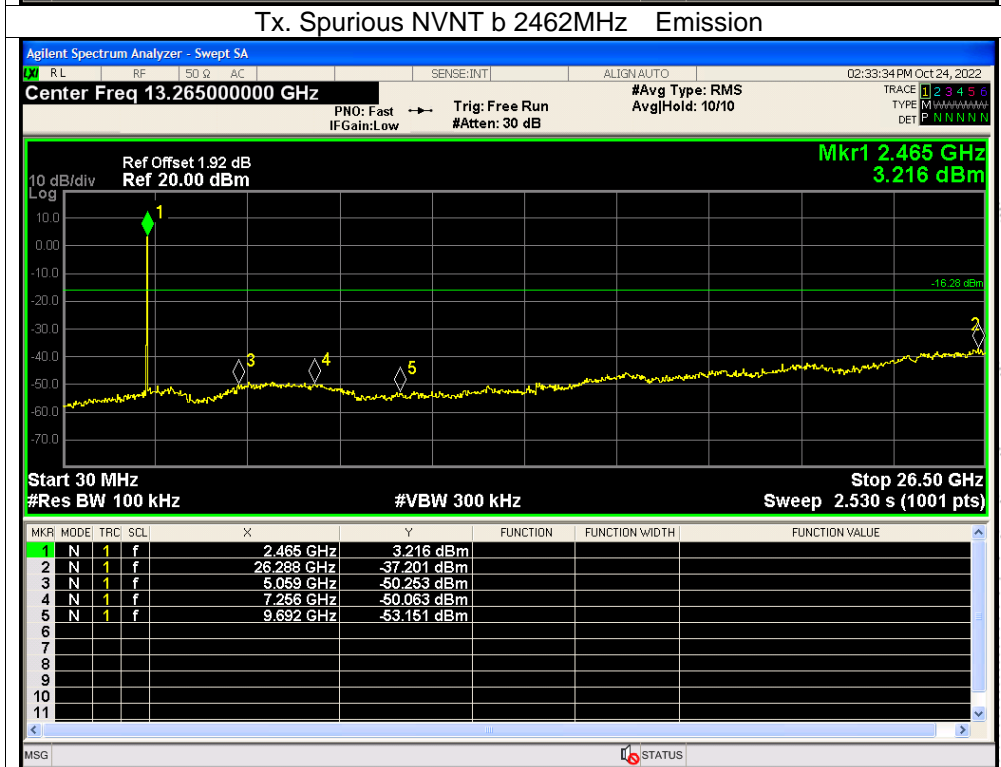
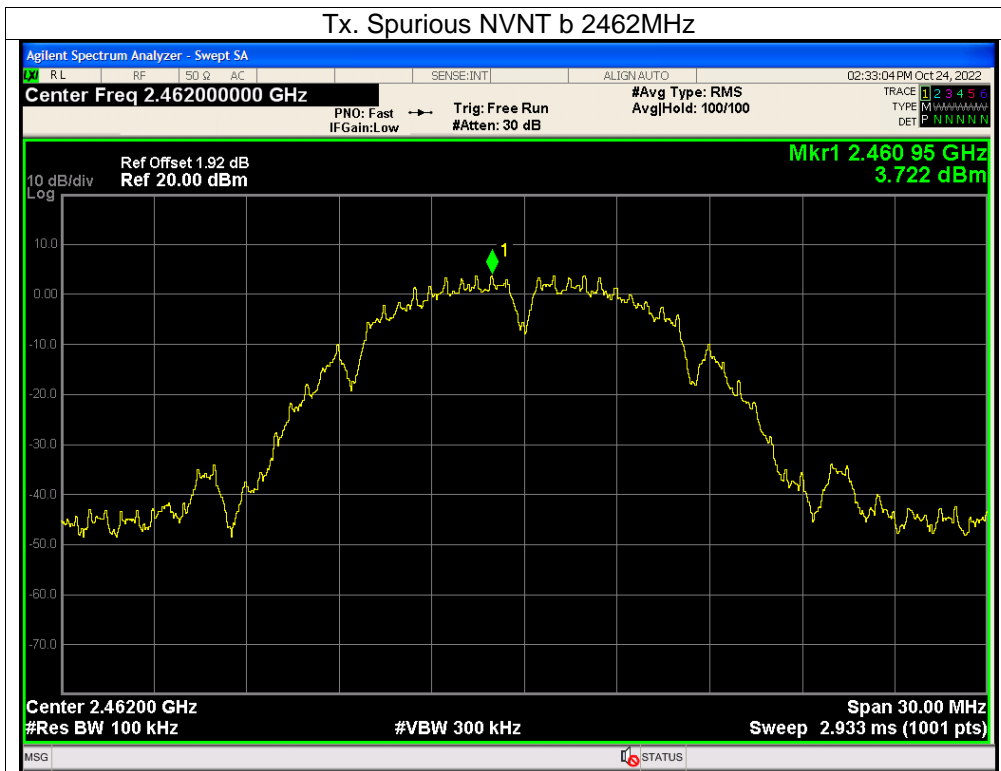

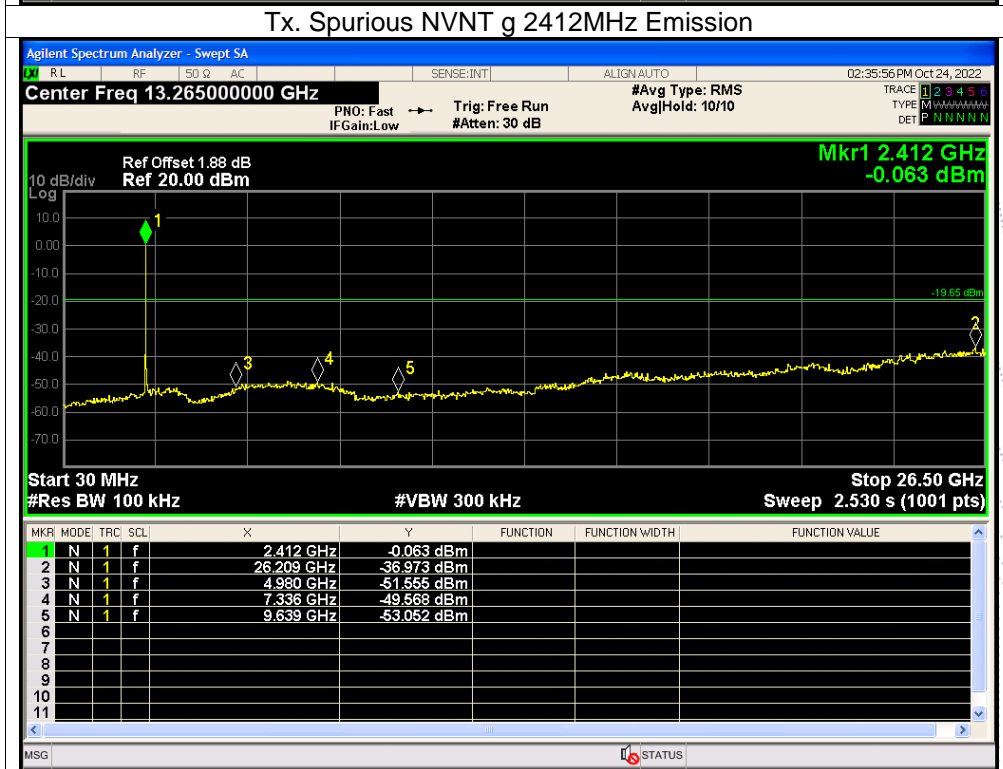
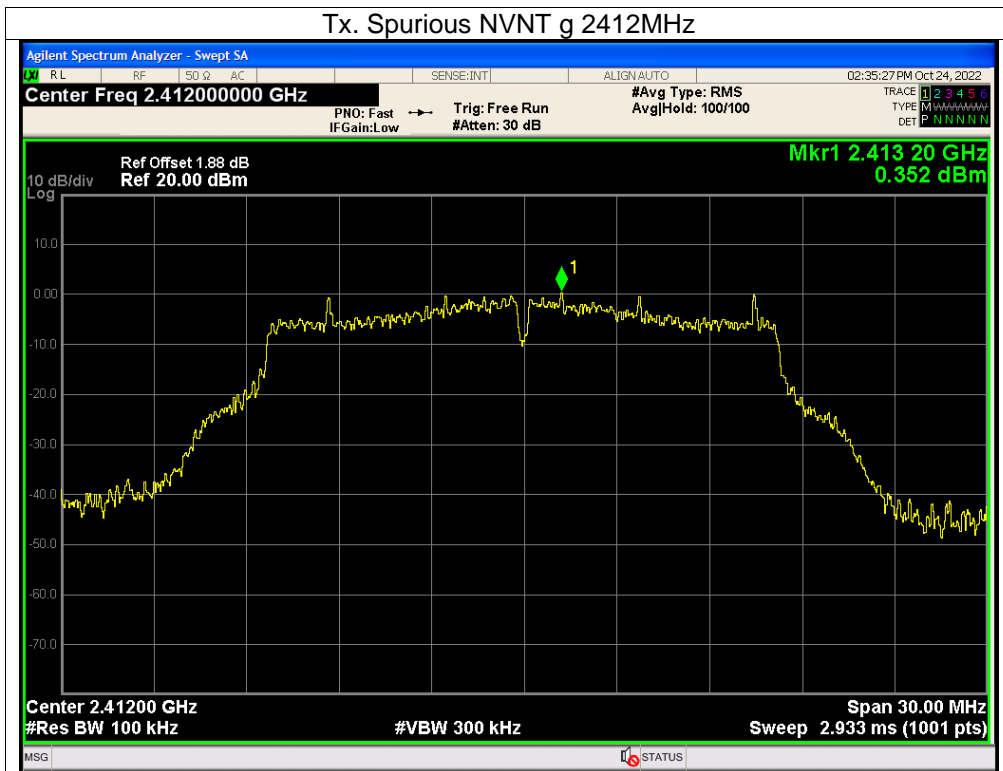

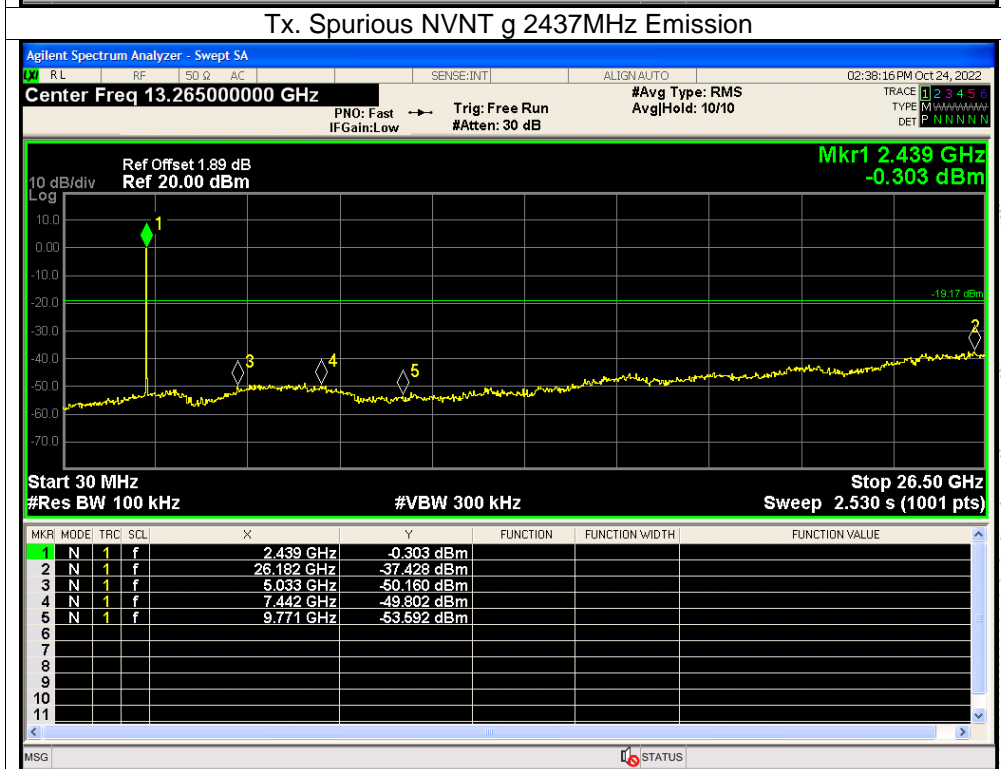
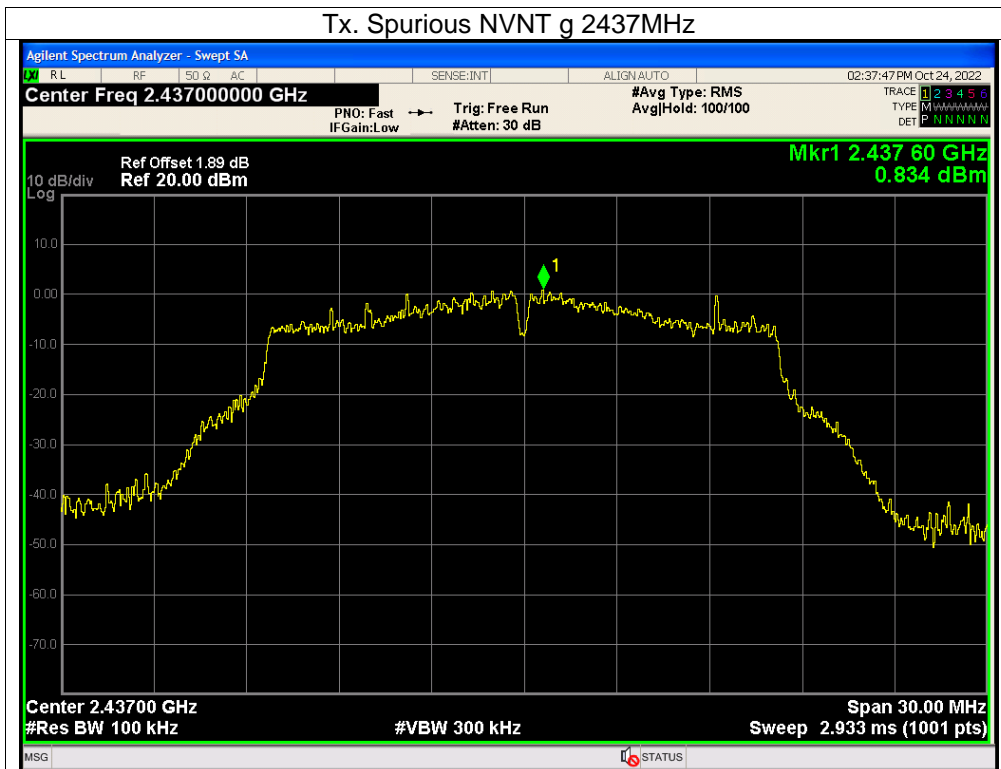

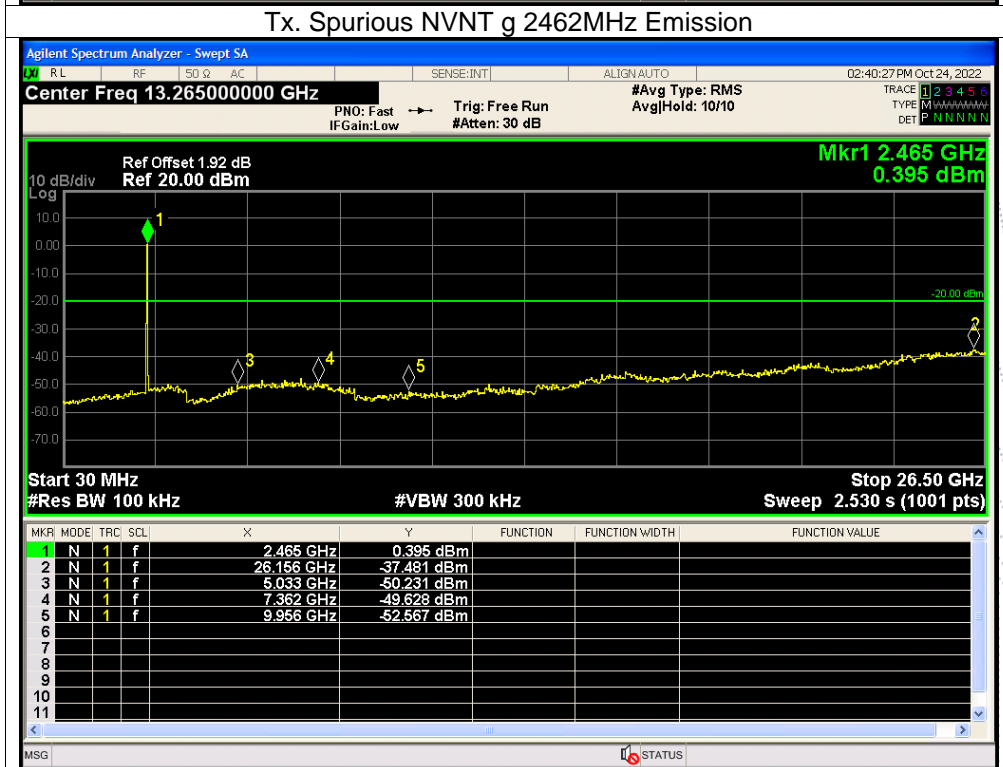
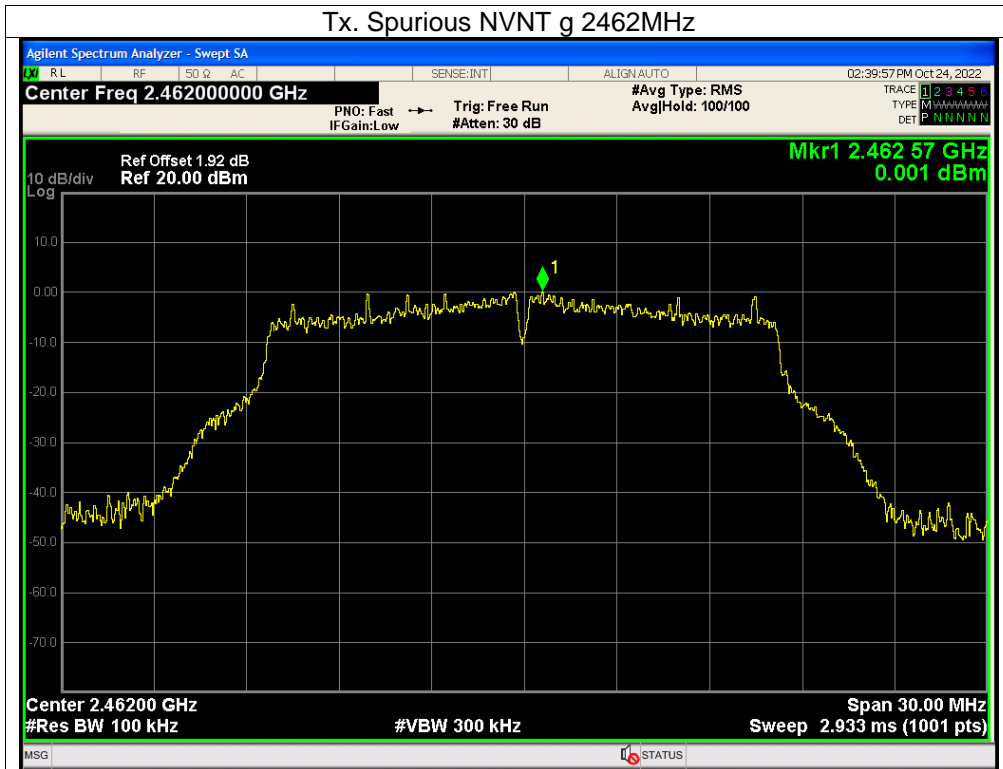

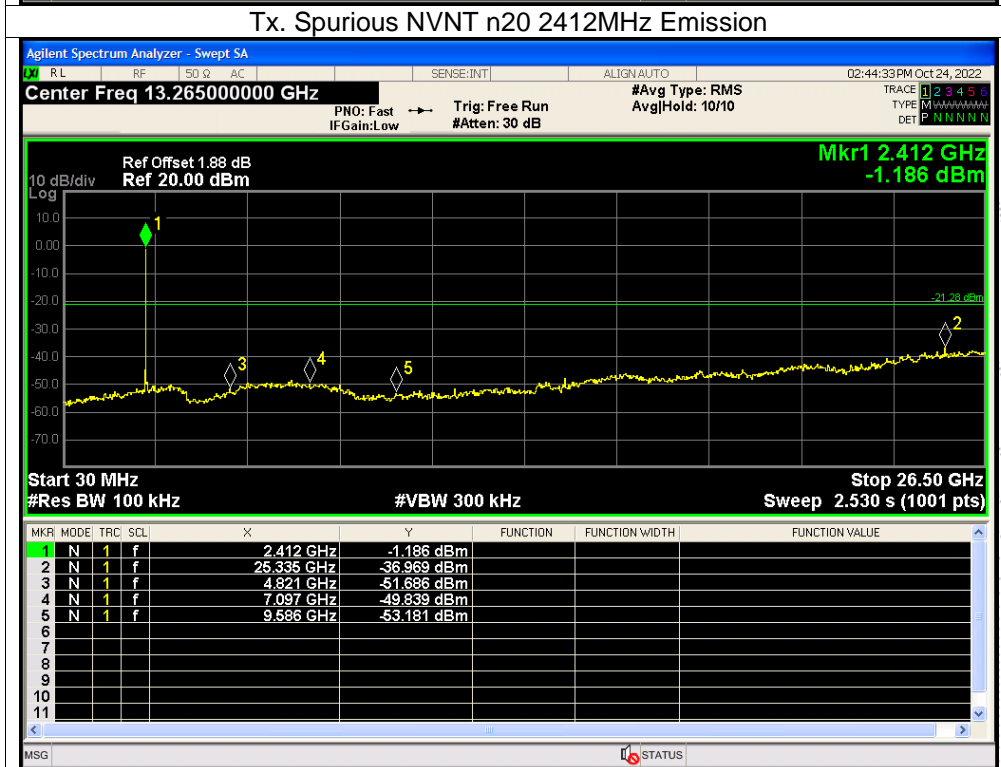
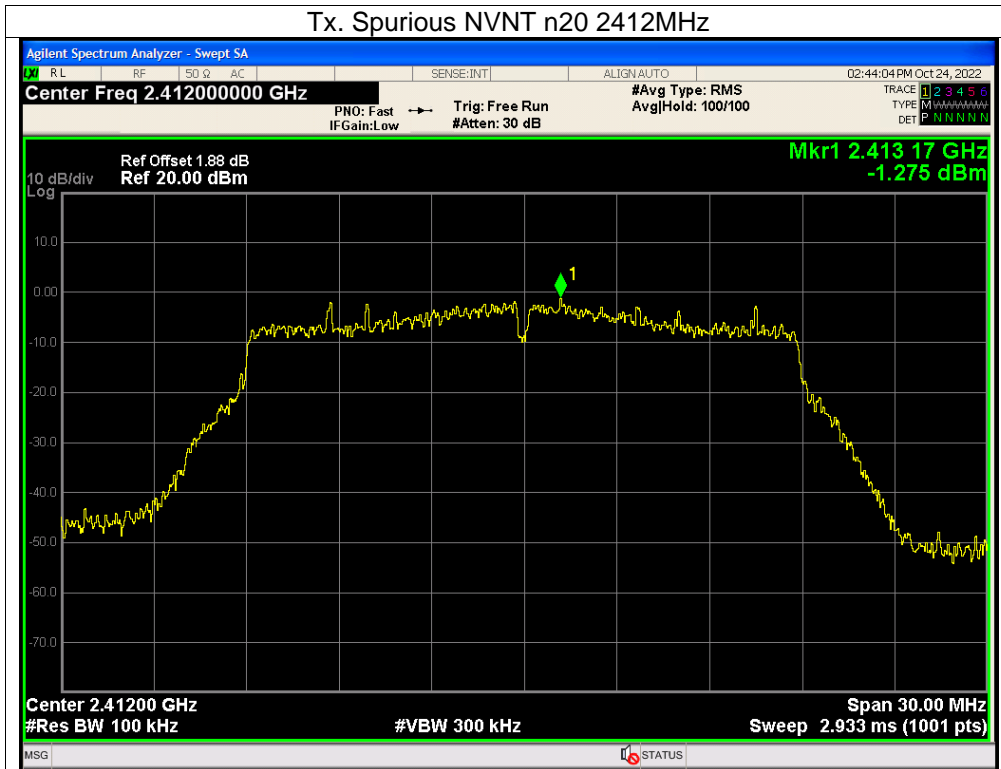

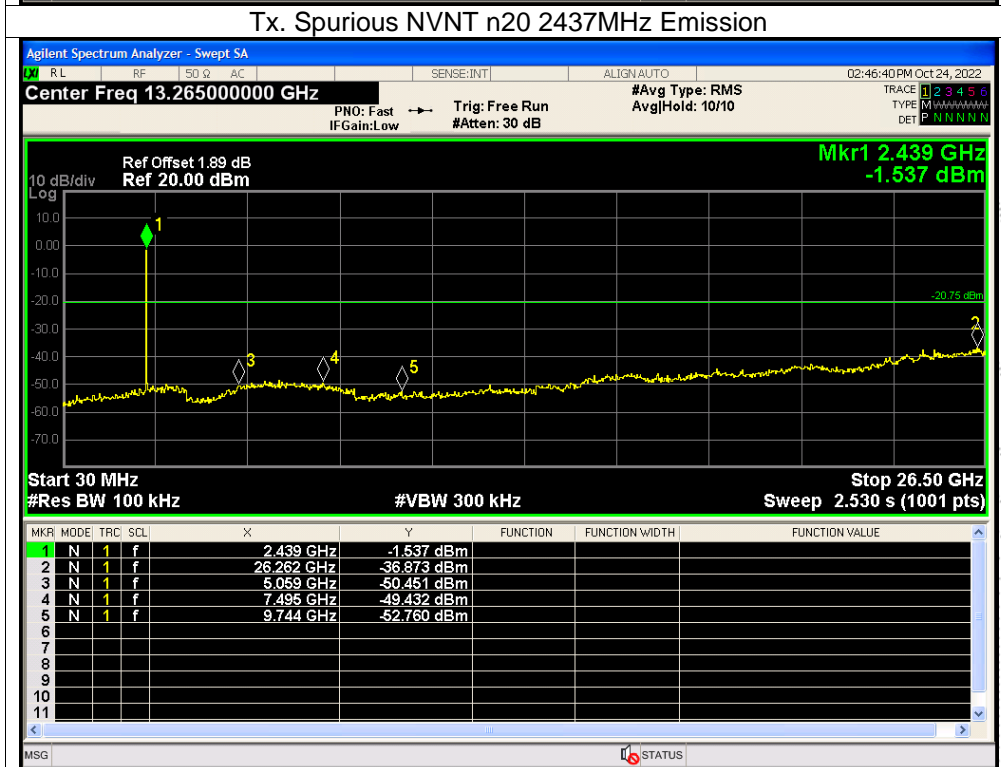
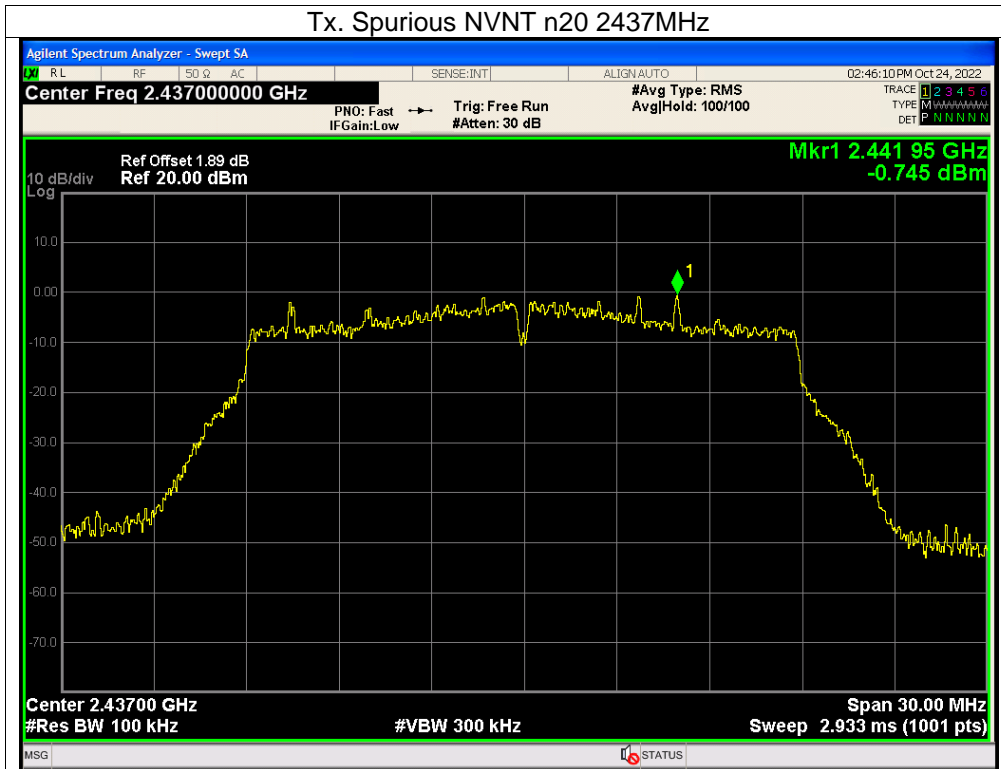

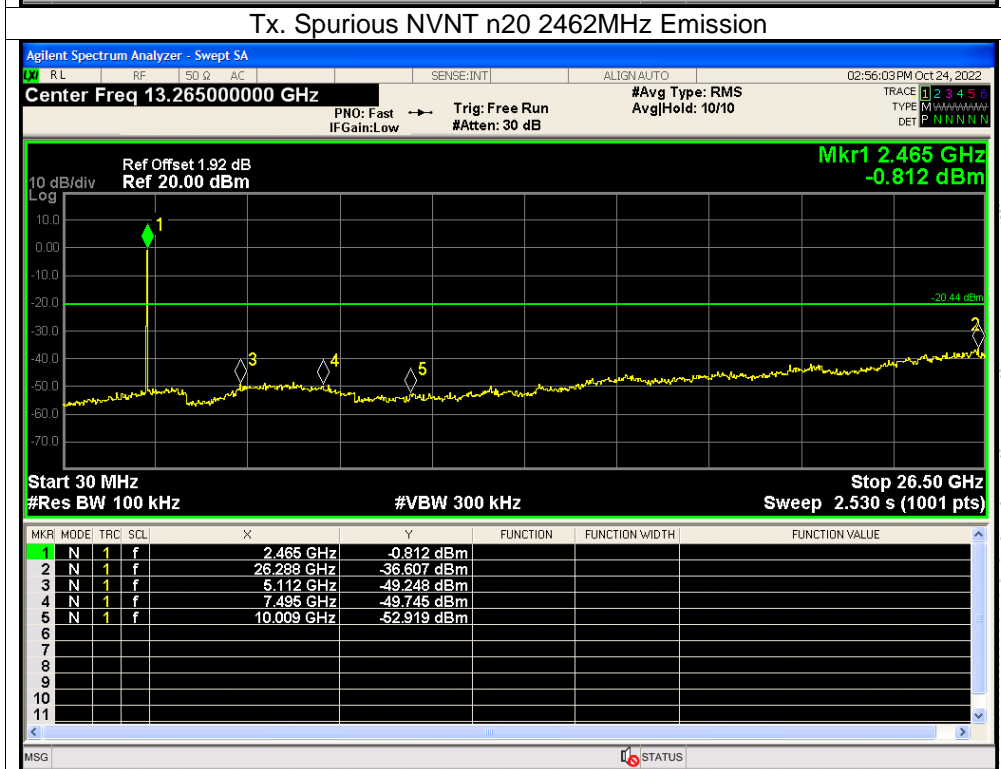
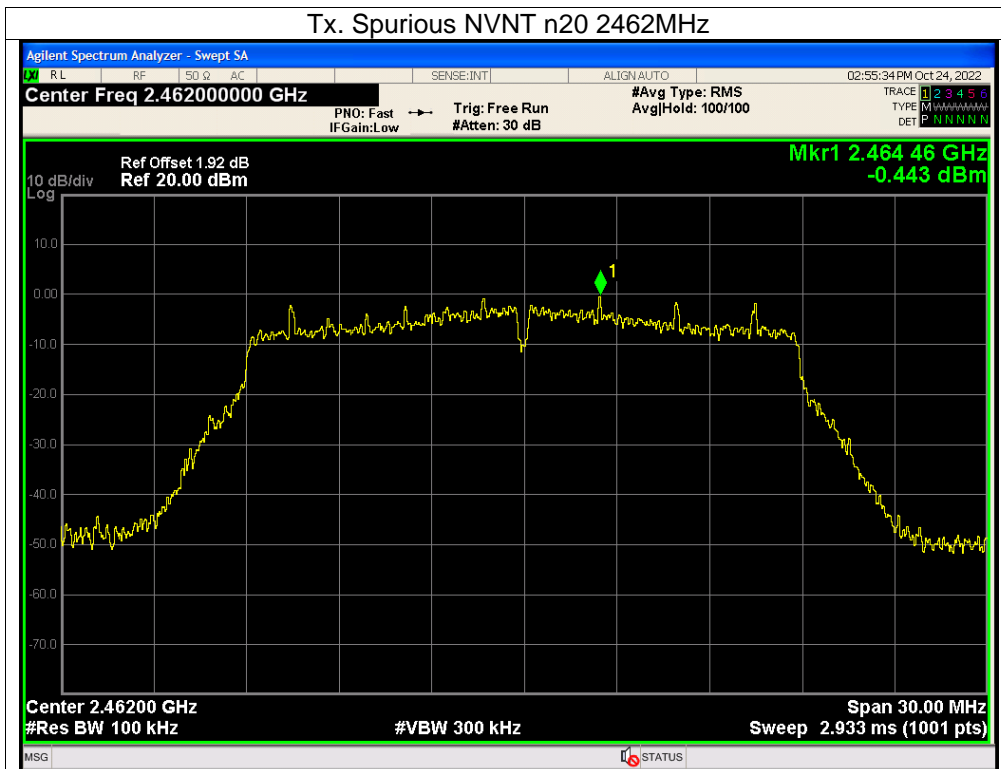

13. Duty Cycle Of Test Signal

13.1 Standard Requirement

Pre-analysis Check: While conducting average power measurement, duty cycle of each mode shall be checked to ensure its duty cycle in order to compensate for the loss due to insufficient ratio of duty cycle. All duty cycle is pre-scanned, and result as obtained below shows only the most representative ones where duty cycle is conducted as the given transmission with given virtual operation that expresses the percentage.

13.2 Formula:

$$\text{Duty Cycle} = \text{Ton} / (\text{Ton} + \text{Toff})$$

Measurement Procedure:

1. Set span = Zero
2. RBW = 8MHz
3. VBW = 8MHz,
4. Detector = Peak

Duty Cycle:

Condition	Mode	Frequency (MHz)	Duty Cycle (%)	Correction Factor (dB)	1/T (kHz)
NVNT	b	2412	100	0	0
NVNT	b	2437	100	0	0
NVNT	b	2462	100	0	0
NVNT	g	2412	100	0	0
NVNT	g	2437	100	0	0
NVNT	g	2462	100	0	0
NVNT	n20	2412	100	0	0
NVNT	n20	2437	100	0	0
NVNT	n20	2462	100	0	0

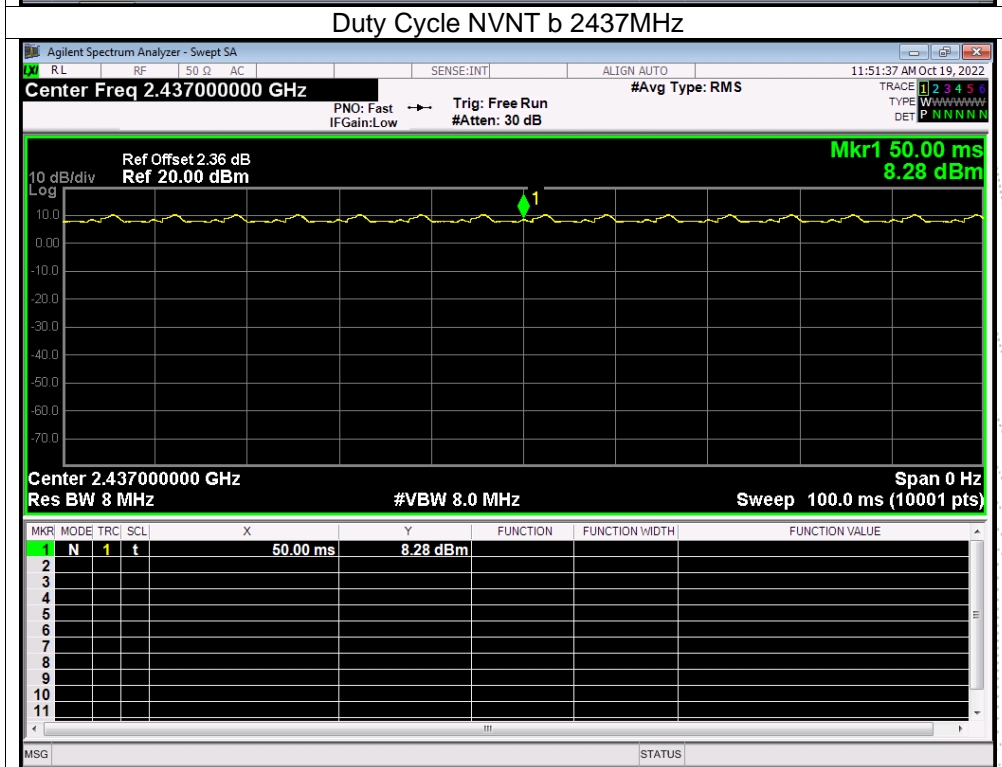
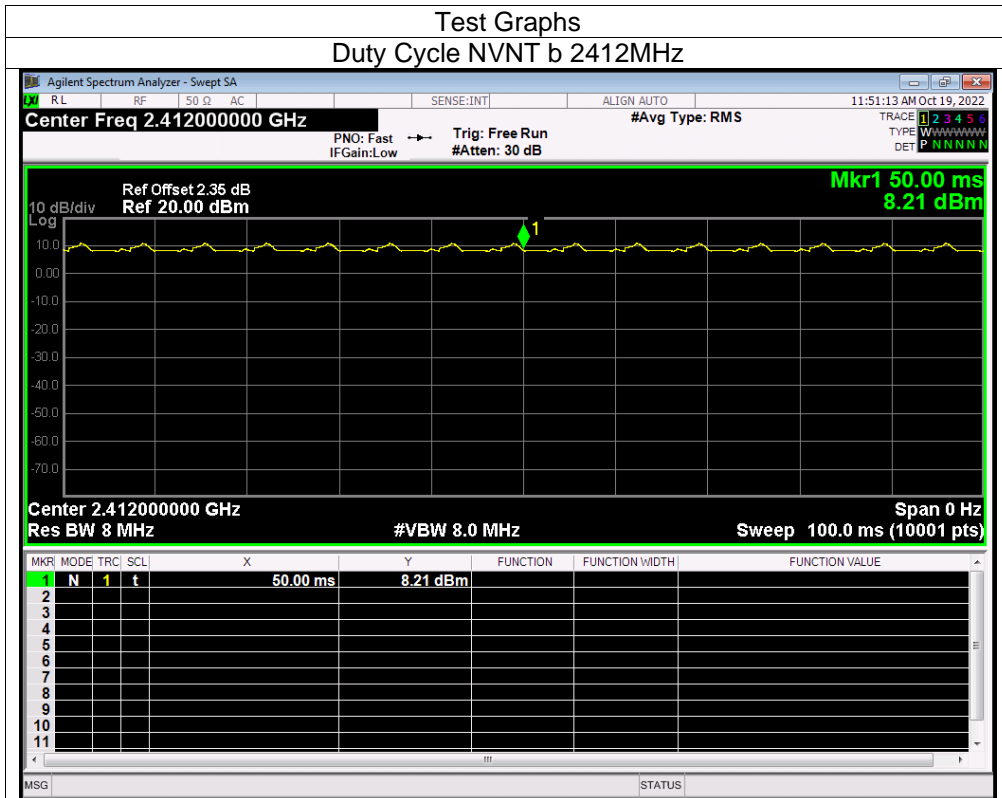

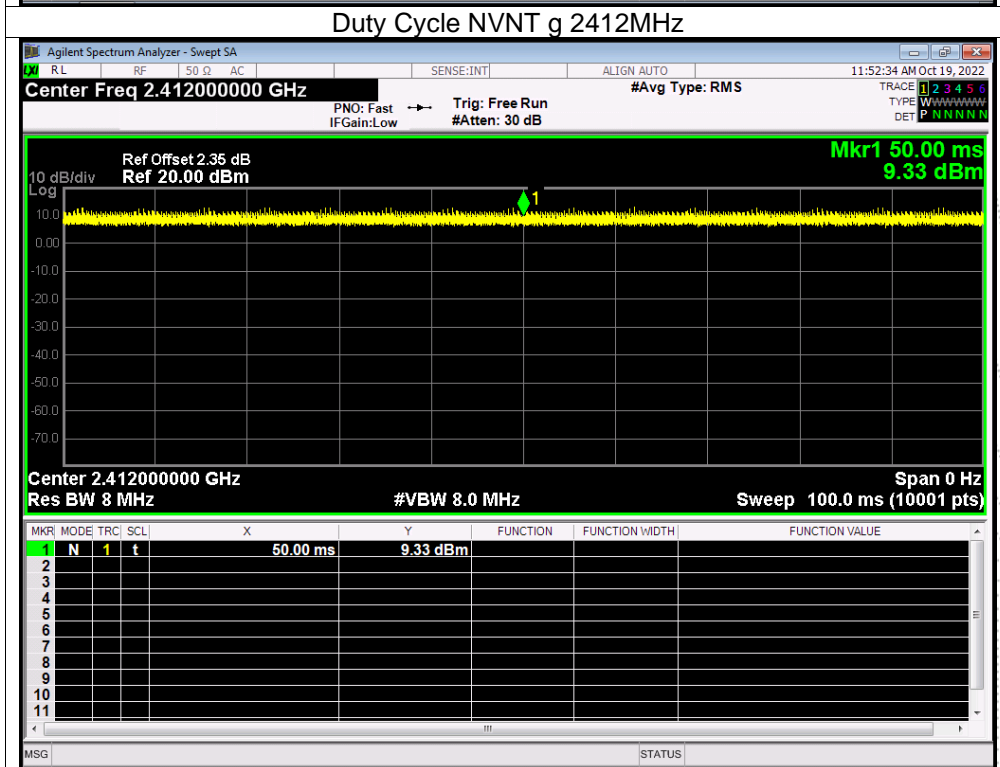
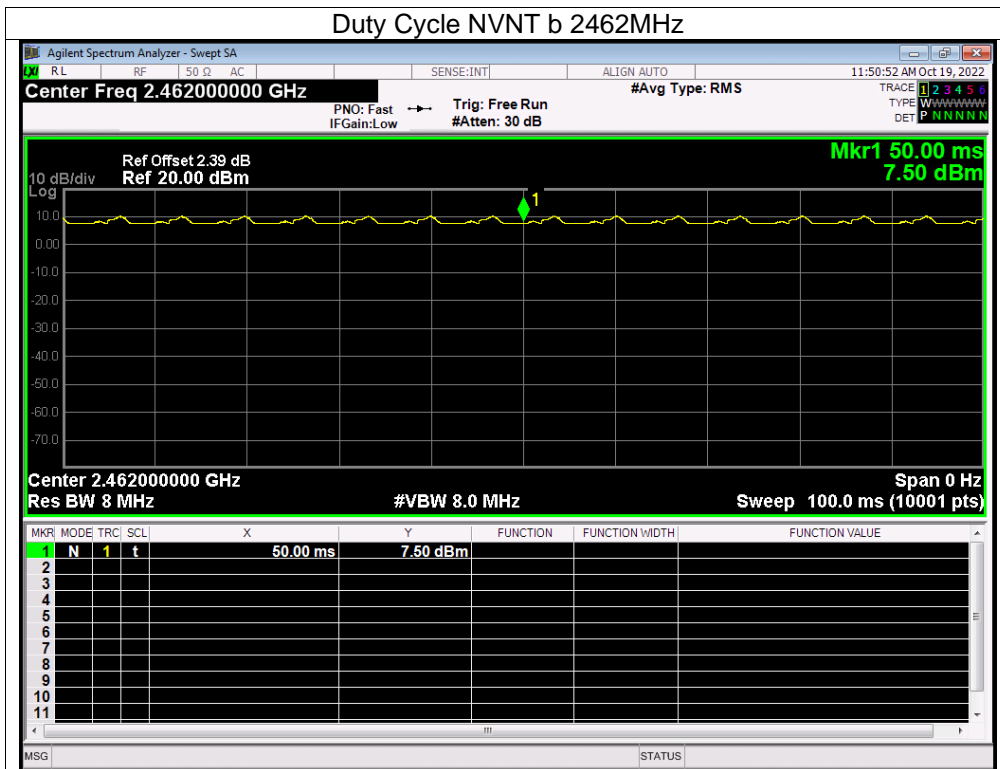

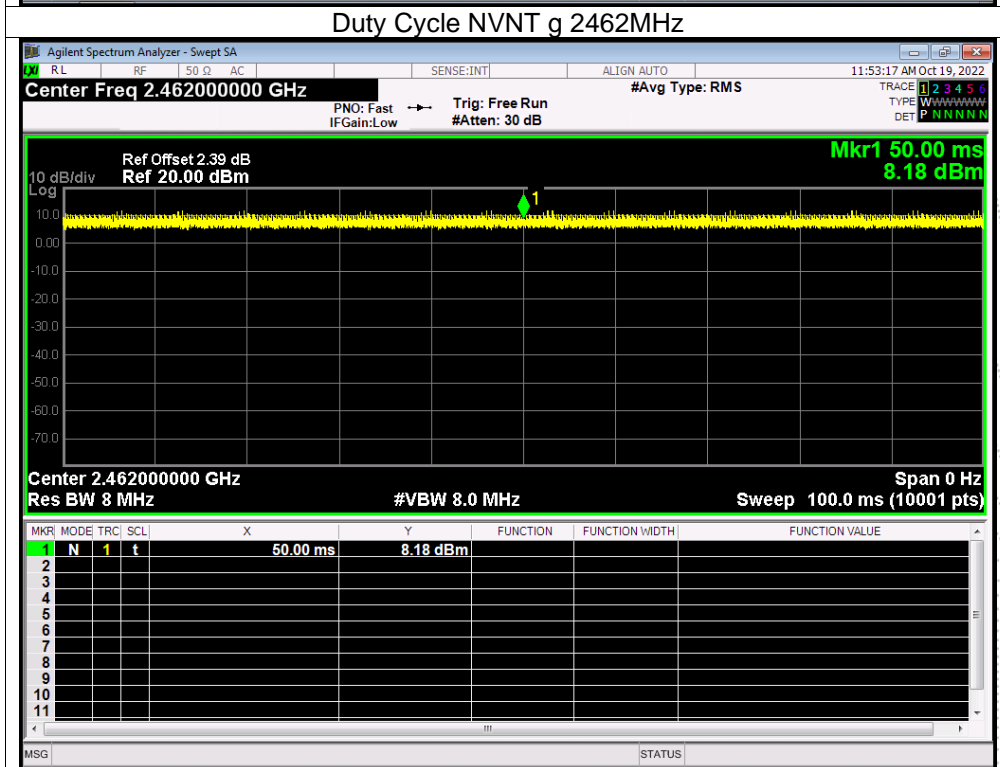
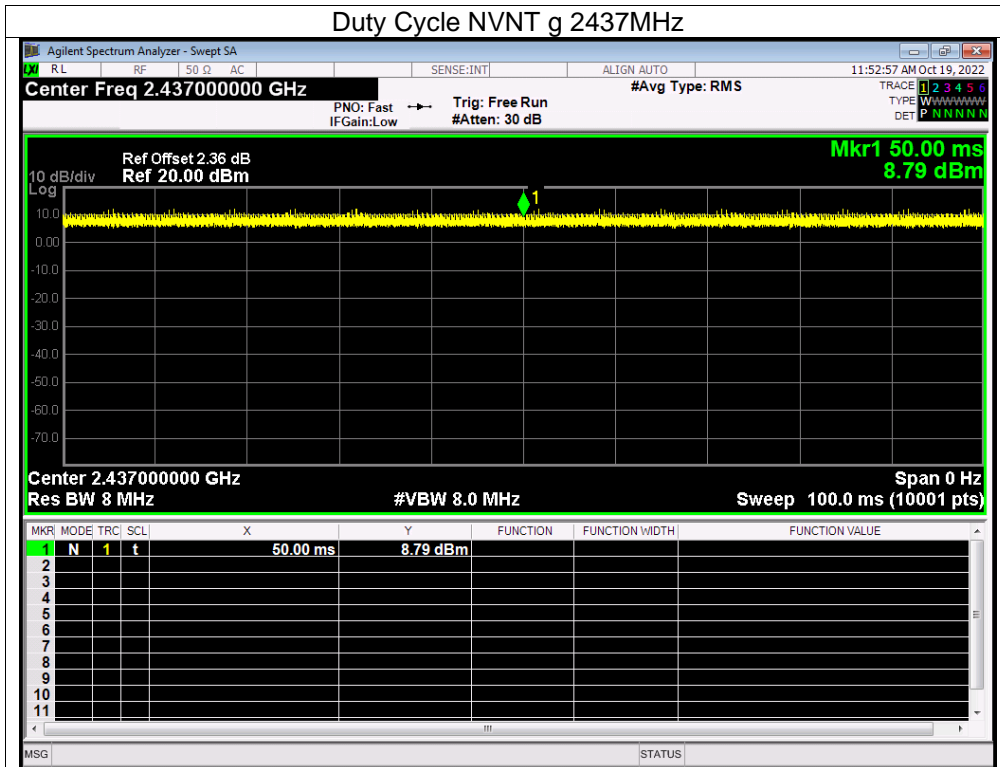

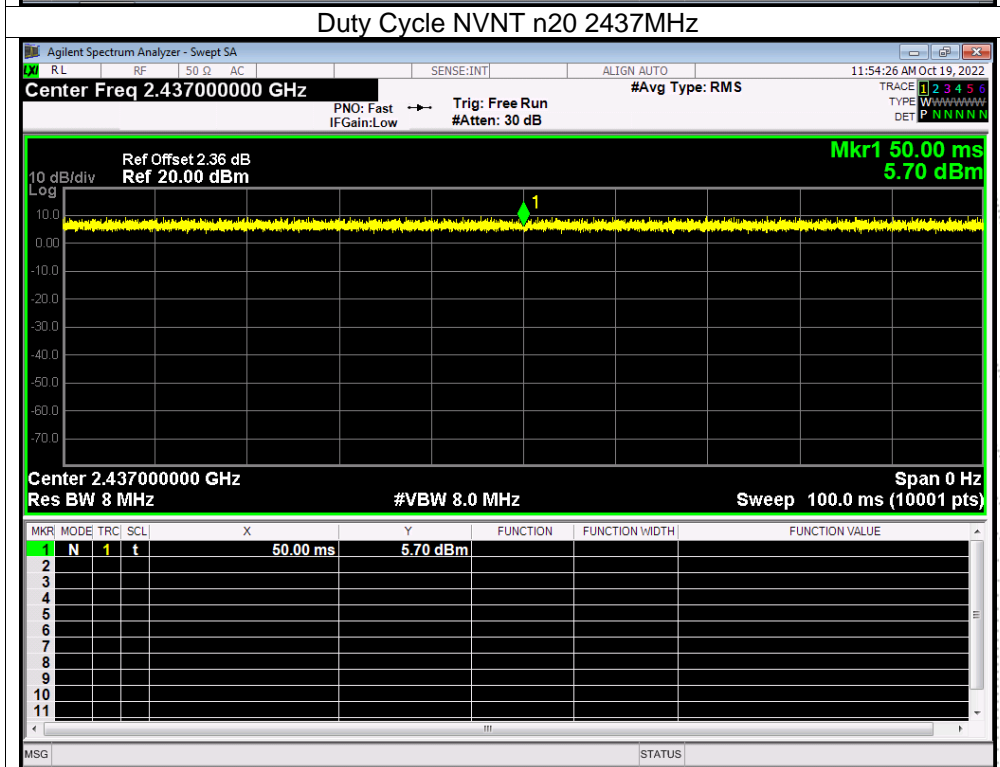
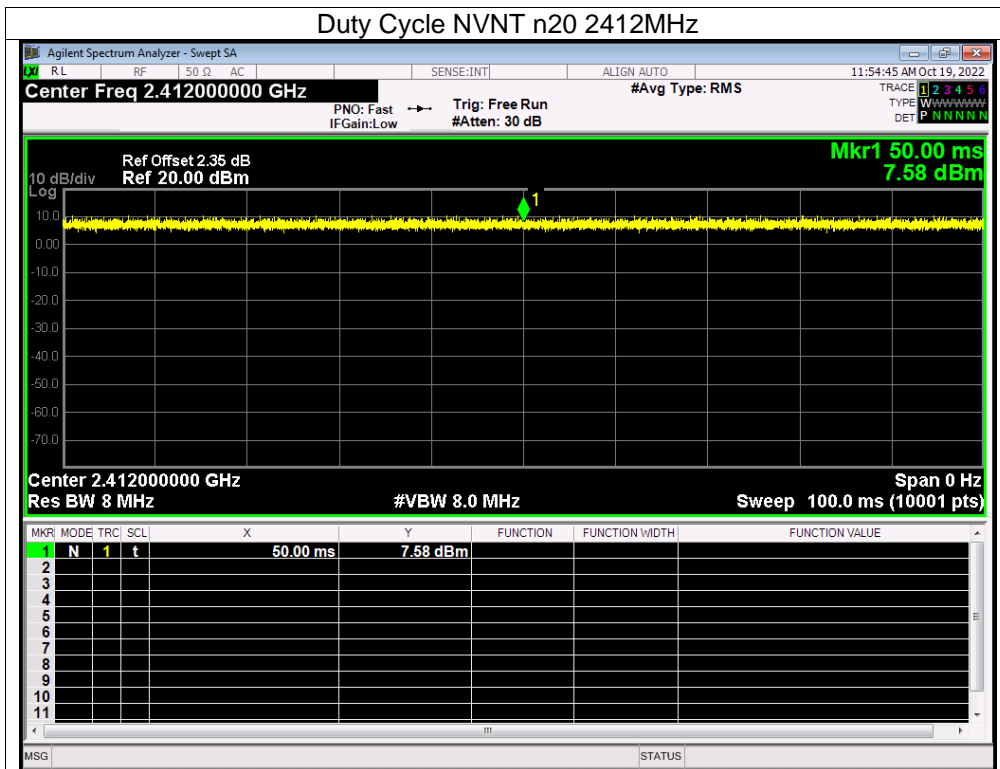

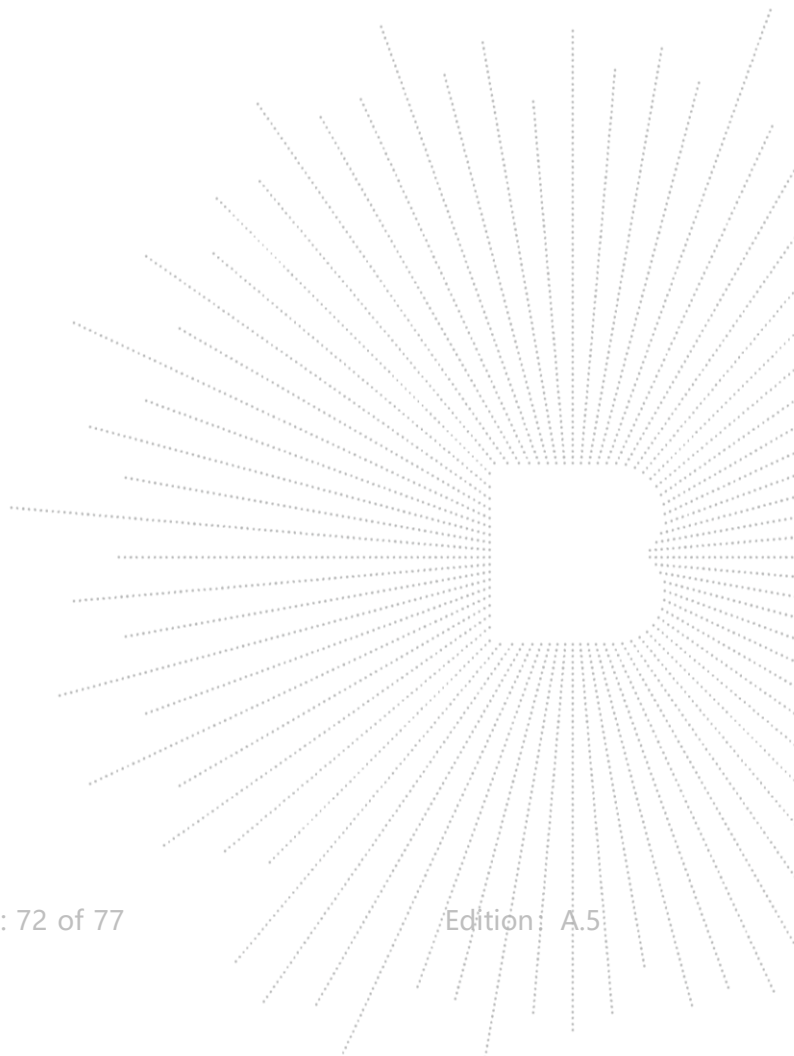
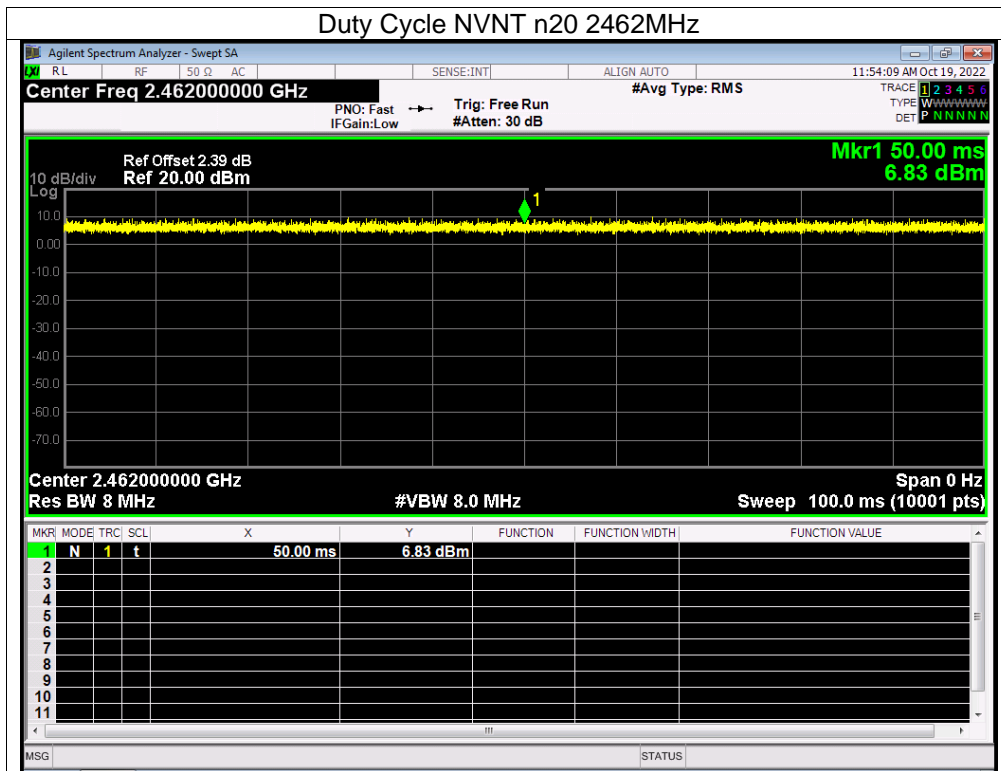

14. Antenna Requirement

14.1 Limit

According to RSS-Gen issue 5, section 6.8, a transmitter can only be sold or operated with antennas with which it was certified. A transmitter may be certified with multiple antenna types. An antenna type comprises antennas having similar in-band and out-of-band radiation patterns.

14.2 Test Result

The EUT antenna is FPC antenna, fulfill the requirement of this section.

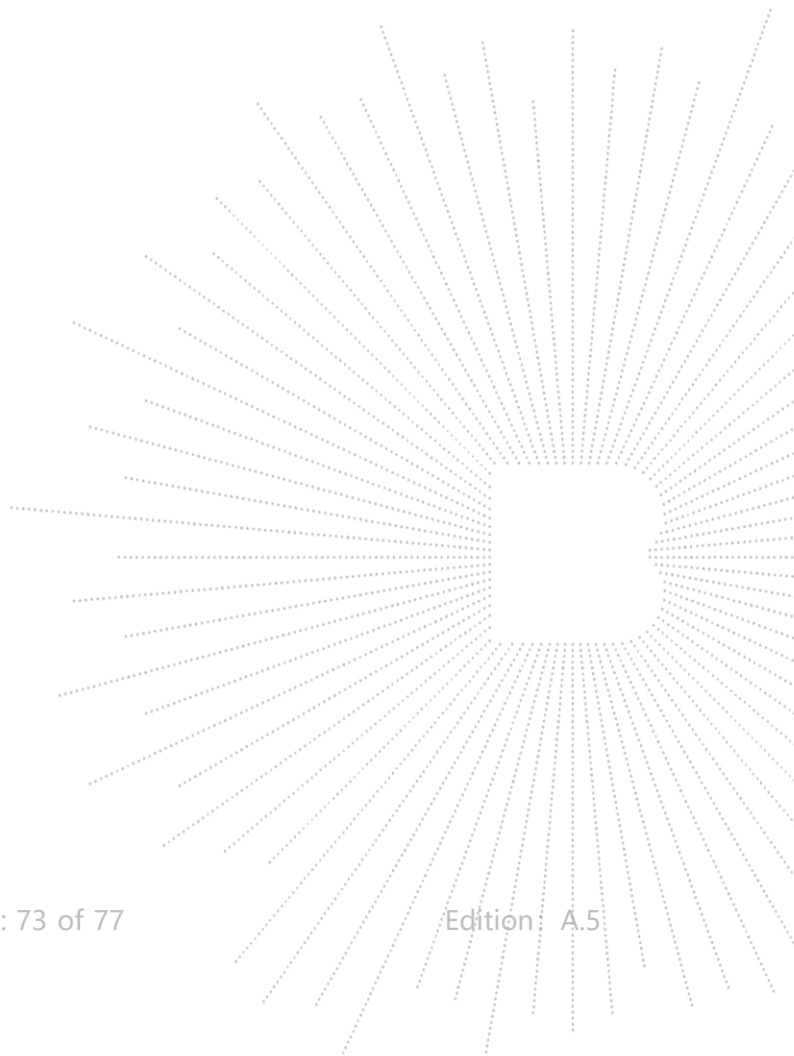

15. EUT Photographs

EUT Photo 1

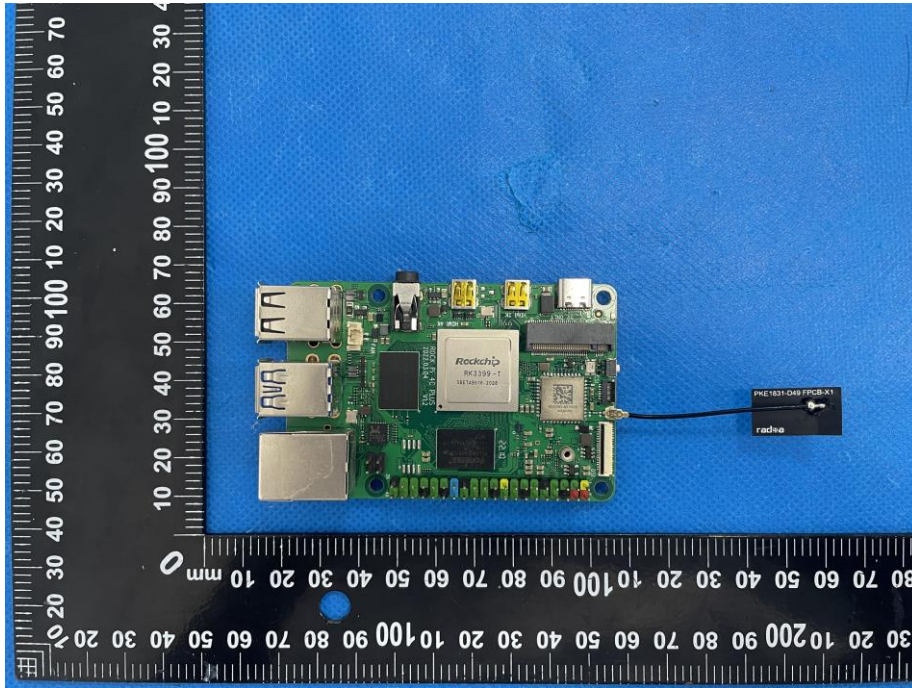

EUT Photo 2

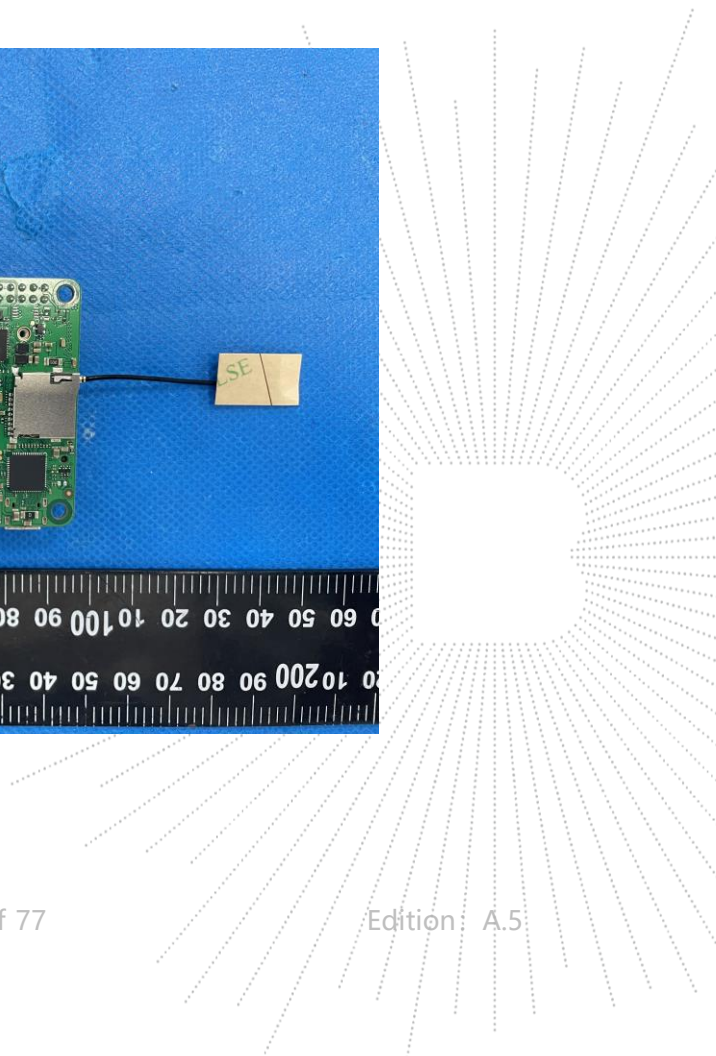
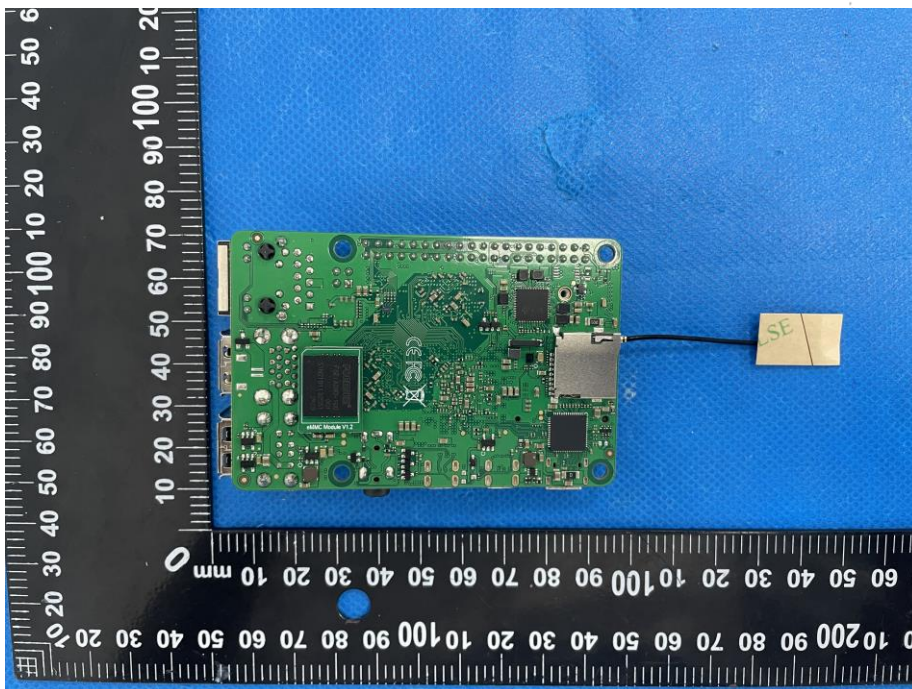

16. EUT Test Setup Photographs

Conducted Emissions Photo



Radiated Measurement Photos



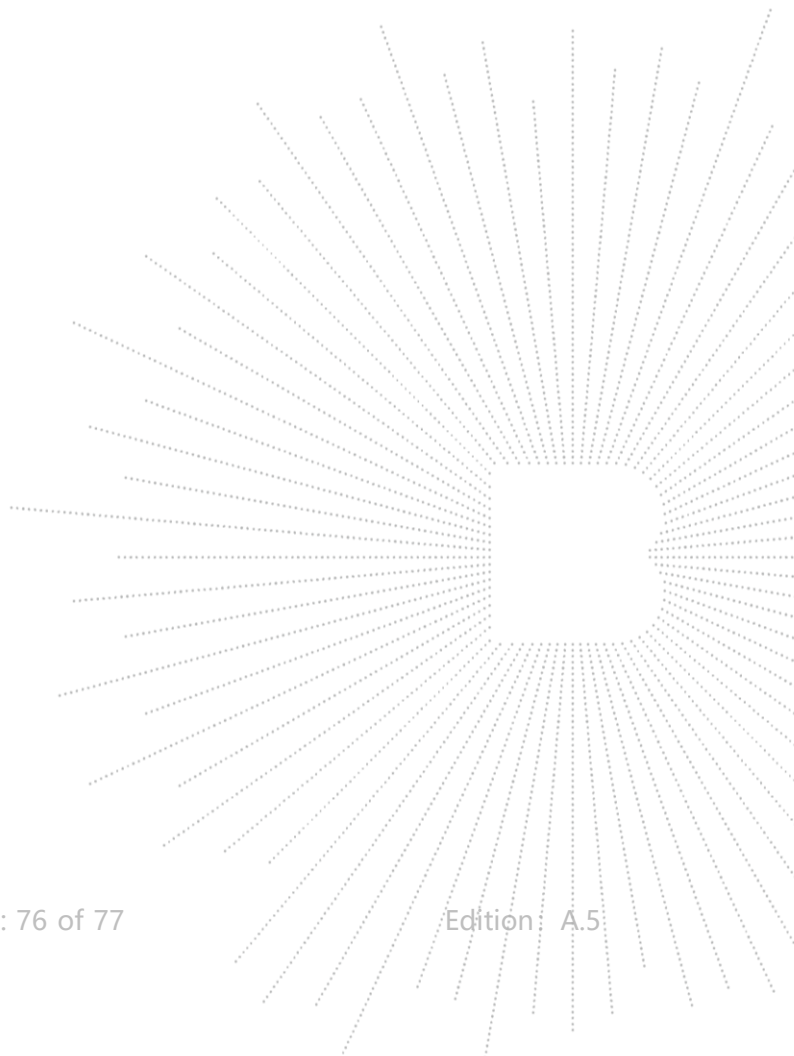

STATEMENT

1. The equipment lists are traceable to the national reference standards.
2. The test report can not be partially copied unless prior written approval is issued from our lab.
3. The test report is invalid without the "special seal for inspection and testing".
4. The test report is invalid without the signature of the approver.
5. The test process and test result is only related to the Unit Under Test.
6. Sample information is provided by the client and the laboratory is not responsible for its authenticity.
7. The test report without CMA mark is only used for scientific research, teaching, enterprise product development and internal quality control purposes.
8. The quality system of our laboratory is in accordance with ISO/IEC17025.
9. If there is any objection to this test report, the client should inform issuing laboratory within 15 days from the date of receiving test report.

Address:

1-2/F., Building B, Pengzhou Industrial Park, No.158, Fuyuan 1st Road, Zhancheng, Fuhai Subdistrict, Bao'an District, Shenzhen, Guangdong, China

TEL: 400-788-9558

P.C.: 518103

FAX: 0755-33229357

Website: <http://www.chnbctc.com>

E-Mail: bctc@bctc-lab.com.cn

***** END *****

