

TEST REPORT

Report No.: BCTC2207596553-6E

Applicant: ROCKPI TRADING LIMITED

Product Name: ROCK Pi 4/ROCK 4

Model/Type
reference: ROCK 4C Plus

Tested Date: 2022-07-19 to 2022-07-26

Issued Date: 2022-07-27

Shenzhen BCTC Testing Co., Ltd.



Product Name: ROCK Pi 4/ROCK 4
Trademark: N/A
Model/Type reference: ROCK 4C Plus
ROCK Pi 4C Plus, ROCK Pi 4C Pro, ROCK Pi 4C Max, ROCK 4C, ROCK 4C Plus,
ROCK 4C Pro, ROCK 4C Max
Prepared For: ROCKPI TRADING LIMITED
Address: Room 11, 27 / f, Ga wah international centre, 191 Javaroad, north point, Hong Kong
Manufacturer: ROCKPI TRADING LIMITED
Address: Room 11, 27 / f, Ga wah international centre, 191 Javaroad, north point, Hong Kong
Prepared By: Shenzhen BCTC Testing Co., Ltd.
Address: 1-2/F., Building B, Pengzhou Industrial Park, No.158, Fuyuan 1st Road,
Zhancheng, Fuhai Subdistrict, Bao'an District, Shenzhen, Guangdong, China
Sample Received Date: 2022-07-19
Sample tested Date: 2022-07-19 to 2022-07-26
Issue Date: 2022-07-27
Report No.: BCTC2207596553-6E
Test Standards: ETSI EN 301 893 V2.1.1 (2017-05)
Test Results: PASS
Remark: This is WIFI-5GHz band radio test report.

Tested by:

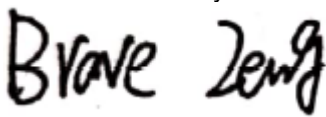

Brave Zeng/ Project Handler

Approved by:



Zero Zhou/Reviewer

The test report is effective only with both signature and specialized stamp. This result(s) shown in this report refer only to the sample(s) tested. Without written approval of Shenzhen BCTC Testing Co., Ltd, this report can't be reproduced except in full. The tested sample(s) and the sample information are provided by the client.

Table Of Content

	Page
Test Report Declaration	
1. Version	5
2. Test Summary	6
3. Measurement Uncertainty	7
4. Product Information And Test Setup	8
4.1 Product Information	8
4.2 Test Setup Configuration	8
4.3 Support Equipment	8
4.4 Channel List	9
4.5 Test Mode	9
4.6 Test Environment	9
5. Test Facility And Test Instrument Used	10
5.1 Test Facility	10
5.2 Test Instrument Used	10
6. Information As Required	11
7. Nominal Centre frequencies	13
7.1 Block Diagram Of Test Setup	13
7.2 Limit	13
7.3 Test procedure	13
7.4 Test Result	13
8. Nominal Channel Bandwidth and Occupied Channel Bandwidth	17
8.1 Block Diagram Of Test Setup	17
8.2 Limit	17
8.3 Test procedure	17
8.4 Test Result	18
9. RF Output Power, Transmit Power Control (TPC)	26
9.1 Block Diagram Of Test Setup	26
9.2 Limit	26
9.3 Test procedure	26
9.4 Test Result	28
10. Power Spectral Density	36
10.1 Block Diagram Of Test Setup	36
10.2 Limit	36
10.3 Test procedure	36
10.4 Test Result	37
11. Transmitter Unwanted Emissions In The Spurious Domain	45
11.1 Block Diagram Of Test Setup	45
11.2 Limits	46
11.3 Test Procedure	46
11.4 Test Results	47
12. Transmitter Unwanted Emissions In The Out-Of-Band Domain	48
12.1 Block Diagram Of Test Setup	48
12.2 Limit	48
12.3 Test procedure	48
12.4 Test Result	49
13. Receiver Spurious Emissions	63

13.1	Block Diagram Of Test Setup.....	63
13.2	Limits.....	63
13.3	Test Procedure	64
13.4	Test Results	65
14.	Adaptivity.....	66
14.1	Block Diagram Of Test Setup.....	66
14.2	Limit	66
14.3	Test procedure	67
14.4	Test Result.....	67
15.	Receiver Blocking.....	68
15.1	Block Diagram Of Test Setup.....	68
15.2	Limit	68
15.3	Test procedure	68
15.4	Test Result.....	69
16.	EUT Photographs.....	70
17.	EUT Test Setup Photographs.....	78

(Note: N/A Means Not Applicable)

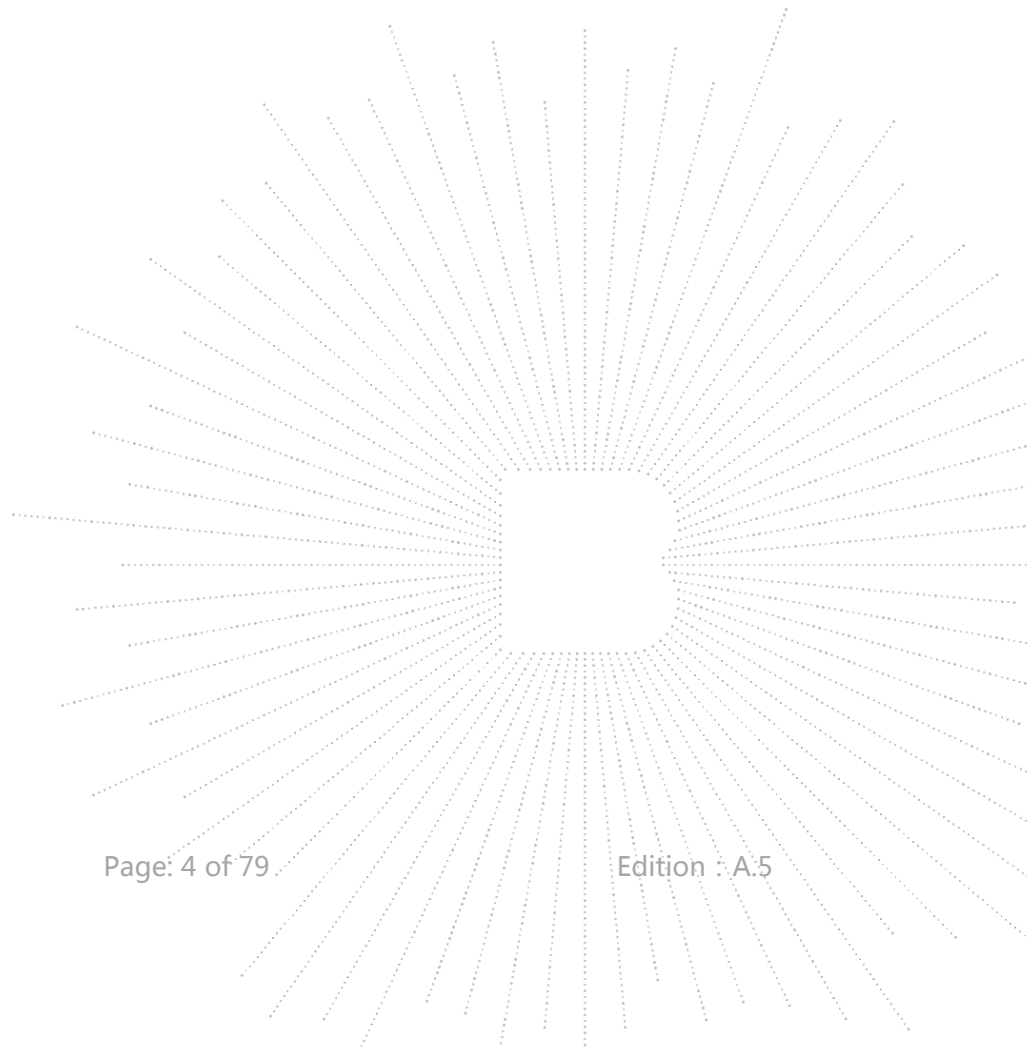

1. Version

Report No.	Issue Date	Description	Approved
BCTC2207596553-6E	2022-07-27	Original	Valid

2. Test Summary

The Product has been tested according to the following specifications:

No.	Test Parameter	Clause No	Results
1	Nominal Centre frequencies	4.2.1	PASS
2	Nominal Channel Bandwidth and Occupied Channel Bandwidth	4.2.2	PASS
3	RF output power, Transmit Power Control (TPC) and Power Density	4.2.3	PASS
4	Transmitter unwanted emissions	4.2.4	PASS
5	Receiver spurious emissions	4.2.5	PASS
6	Dynamic Frequency Selection (DFS)	4.2.6	N/A
7	Adaptivity (Channel Access Mechanism)	4.2.7	PASS
8	Receiver Blocking	4.2.8	PASS
9	User Access Restrictions	4.2.9	PASS

Note: N/A is an abbreviation for Not Applicable and means this test item is not applicable for this device according to the technology characteristic of device.

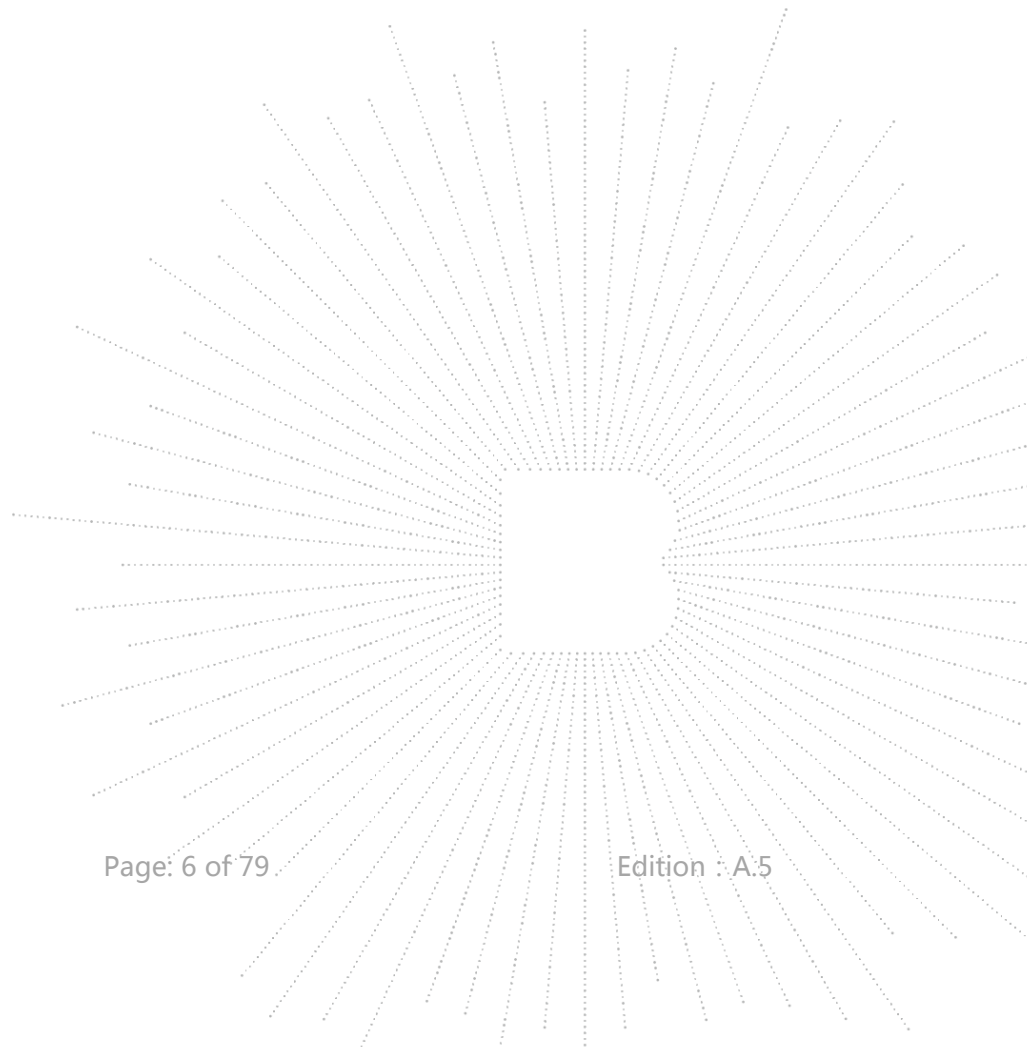

3. Measurement Uncertainty

Where relevant, the following measurement uncertainty levels have been estimated for tests performed on the Product as specified in CISPR 16-4-2. This uncertainty represents an expanded uncertainty expressed at approximately the 95% confidence level using a coverage factor of k=2.

RF frequency	1×10^{-7}
RF power, conducted	± 1.0 dB
Conducted emission of receivers	± 1 dB
Radiated emission of transmitter	± 6 dB
Radiated emission of receiver	± 6 dB
Temperature	± 1 degree
Humidity	± 5 %

4. Product Information And Test Setup

4.1 Product Information

Model/Type reference:	ROCK 4C Plus ROCK Pi 4C Plus, ROCK Pi 4C Pro, ROCK Pi 4C Max, ROCK 4C, ROCK 4C Plus, ROCK 4C Pro, ROCK 4C Max
Model differences:	All the model are the same circuit and RF module, except model names.
Hardware Version:	N/A
Software Version:	N/A
Operation Frequency:	WiFi (5.1GHz): IEEE 802.11a/n/ac HT20:5180MHz-5240MHz IEEE 802.11n/ac HT40:5190MHz-5230MH IEEE 802.11ac HT80:5210MHz
Max. RF output power:	WiFi (5.1GHz): 10.86 dBm
Type of Modulation:	WiFi: DSSS, OFDM
Antenna installation:	FPC antenna
Antenna Gain:	2 dBi
Ratings:	DC 5V From adapter

4.2 Test Setup Configuration

See test photographs attached in EUT TEST SETUP PHOTOGRAPHS for the actual connections between Product and support equipment.

4.3 Support Equipment

No.	Device Type	Brand	Model	Series No.	Note
1.	---	---	---	---	---

Notes:

1. All the equipment/cables were placed in the worst-case configuration to maximize the emission during the test.
2. Grounding was established in accordance with the manufacturer's requirements and conditions for the intended use.

4.4 Channel List

CH	Frequency (MHz)	CH	Frequency (MHz)	CH	Frequency (MHz)	CH	Frequency (MHz)
36	5180	38	5190	40	5200	42	5210
44	5220	46	5230	48	5240		

4.5 Test Mode

All test mode(s) and condition(s) mentioned were considered and evaluated respectively by performing full tests, the worst data were recorded and reported.

Test mode	Low channel	Middle channel	High channel
Transmitting(802.11a HT20)	5180MHz	5200 MHz	5240 MHz
Transmitting(802.11n HT20)	5180MHz	5200 MHz	5240 MHz
Transmitting(802.11ac HT20)	5180MHz	5200 MHz	5240 MHz
Transmitting(802.11n HT40)	5190Mhz	/	5230 MHz
Transmitting(802.1 ac HT40)	5190Mhz	/	5230 MHz
Transmitting(802.11ac HT80)	/	5210 MHz	/
Receiving(802.11a HT20)	5180MHz	5200 MHz	5240 MHz
Receiving(802.11n HT20)	5180MHz	5200 MHz	5240 MHz
Receiving(802.11ac HT20)	5180MHz	5200 MHz	5240 MHz
Receiving(802.11n HT40)	5190Mhz	/	5230 MHz
Receiving(802.11ac HT40)	5190Mhz	/	5230 MHz
Receiving(802.11ac HT80)	/	5210 MHz	/

4.6 Test Environment

1. Normal Test Conditions:

Humidity(%):	54
Atmospheric Pressure(kPa):	101
Temperature(°C):	26
Test Voltage(DC):	5V

2. Extreme Test Conditions:

For tests at extreme temperatures, measurements shall be made over the extremes of the operating temperature range as declared by the manufacturer.

For tests at extreme voltages, measurements shall be made over the extremes of the power source voltage range as declared by the manufacturer.

Test Conditions	LT	HT
Temperature (°C)	-10	35

5. Test Facility And Test Instrument Used

5.1 Test Facility

All measurement facilities used to collect the measurement data are located at Shenzhen BCTC Testing Co., Ltd. Address: 1-2/F., Building B, Pengzhou Industrial Park, No.158, Fuyuan 1st Road, Zhancheng, Fuhai Subdistrict, Bao'an District, Shenzhen, Guangdong, China. The site and apparatus are constructed in conformance with the requirements of ANSI C63.4 and CISPR 16-1-1 other equivalent standards.

5.2 Test Instrument Used

Item	Equipment	Manufacturer	Type No.	Serial No.	Last calibration	Calibrated until
1	966 chamber	ChengYu	966 Room	966	Jun. 06. 2020	Jun. 05, 2023
2	Receiver	R&S	ESR3	102075	May 24, 2022	May 23, 2023
3	Spectrum Analyzer	Agilent	E4407B	MY45109572	May 24, 2022	May 23, 2023
4	Amplifier	SKET	LAPA_01G18G -45dB	\	May 24, 2022	May 23, 2023
5	Amplifier	Schwarzbeck	BBV9744	9744-0037	May 24, 2022	May 23, 2023
6	TRILOG Broadband Antenna	schwarzbeck	VULB 9163	VULB9163-942	May 26, 2022	May 25, 2023
7	Horn Antenna	SCHWARZBECK K	BBHA9120D	1541	May 26, 2022	May 25, 2023
8	band rejection filter	ZBSF	ZBSF-C2441.5	1706003606	May 24, 2022	May 23, 2023
9	Signal Generator	Keysight	N5181A	MY50143748	May 24, 2022	May 23, 2023
10	Communication test set	R&S	CMU200	119435	May 24, 2022	May 23, 2023
11	Spectrum Analyzer	Keysight	N9020A	MY49100060	May 24, 2022	May 23, 2023
12	Signal Generator	Keysight	N5182B	MY56200519	May 24, 2022	May 23, 2023
13	Power Meter	Keysight	E4419B	\	May 24, 2022	May 23, 2023
14	Power Sensor	Keysight	E9 300A	\	May 24, 2022	May 23, 2023
15	Horn antenna	SCHWARZBECK	BBHA9170	00822	Jun. 06, 2022	Jun. 05, 2023
16	Preamplifier	MITEQ	TA1840-35-HG	2034381	May 24, 2022	May 23, 2023
17	Software	Frad	EZ-EMC	FA-03A2 RE	\	\
18	Software	Keysight	Keysight.ETSLT test system	1.02.05	\	\
19	D.C. Power Supply	LongWei	TPR-6405D	\	\	\
20	Loop Antenna	Schwarzbeck	FMZB1519B	00014	Jun. 06, 2022	Jun. 05, 2023
21	Communication test set	Agilent	N4010A	MY49081107	May 24, 2022	May 23, 2023
22	Programmable constant temperature and humidity test chamber	DGBELL	BTKS5-150C	\	May 24, 2022	May 23, 2023

6. Information As Required

ETSI EN 301 893 V2.1.1 Annex G

a) The Nominal Channel Bandwidth(s):
Refer to section 4.4 channel list.
b) For Load Based Equipment that supports multi-channel operation:
N/A
c) The different transmit operating modes (see clause 5.3.3.2) (tick all that apply):
<input type="checkbox"/> Operating mode 1: Single Antenna Equipment
<input type="checkbox"/> a) Equipment with only 1 antenna
d) In case of Smart Antenna Systems or multiple antenna systems:
<ul style="list-style-type: none"> The number of Receive chains: ..2 The number of Transmit chains: ..2... Equal power distribution among the transmit chains: <input checked="" type="checkbox"/> Yes <input type="checkbox"/> No In case of beamforming, the maximum (additional) beamforming gain: .(Antenna B) : 2.71dBi NOTE: Beamforming gain does not include the basic gain of a single antenna (assembly).
e) TPC feature available:
<input type="checkbox"/> Yes <input checked="" type="checkbox"/> No
f) For equipment with TPC range:
The lowest and highest power level (or lowest and highest e.i.r.p. level in case of integrated antenna equipment),intended antenna assemblies and corresponding operating frequency range for the TPC range (or for each of the TPC ranges if more than one is implemented).
g) For equipment without a TPC range:
Power Setting 1: Max.
h) The DFS related operating mode(s) of the equipment:
N/A
i) User access restrictions (please check box below to confirm):
N/A
j) For equipment with Off-Channel CAC functionality:
N/A
k) The equipment can operate in ad-hoc mode:
N/A
l) Operating Frequency Range(s):
Refer to section 4.1.
m) The extreme operating temperature and supply voltage range that apply to the equipment:
Refer to section 4.6
n) The test sequence/test software used (see also ETSI EN 301 893 (V2.1.1), clause 5.3.1.2):
Provide by manufacturer.
o) Type of Equipment:
<input checked="" type="checkbox"/> Stand-alone
<input type="checkbox"/> Combined Equipment (Equipment where the radio part is fully integrated within another type of equipment)
<input type="checkbox"/> Plug-in radio device (Equipment intended for a variety of host systems)
<input type="checkbox"/> Other
p) Adaptivity (Channel Access Mechanism):
<input type="checkbox"/> Frame Based Equipment
<input checked="" type="checkbox"/> Load Based Equipment
q) With regards to Adaptivity for Frame Based Equipment
<input checked="" type="checkbox"/> The Frame Based Equipment operates as an Initiating Device
<input type="checkbox"/> The Frame Based Equipment operates as an Responding Device
<input type="checkbox"/> The Frame Based Equipment can operate as an Initiating Device and as a Responding Device
r) With regards to Adaptivity for Load Based Equipment
N/A
s) The equipment supports a geo-location capability as defined in clause 4.2.10 of ETSI EN 301 893

V2.1.1:
<input type="checkbox"/> Yes <input checked="" type="checkbox"/> No
t) The minimum performance criteria (see ETSI EN 301 893 V2.1.1, clause 4.2.8.3) that corresponds to the intended use of the equipment:
The minimum performance criterion is a PER of less than or equal to 10 %.
u) The theoretical maximum radio performance of the equipment (e.g. maximum throughput) (see ETSI EN 301 893 V2.1.1, clause 5.4.9.3.1):
N/A

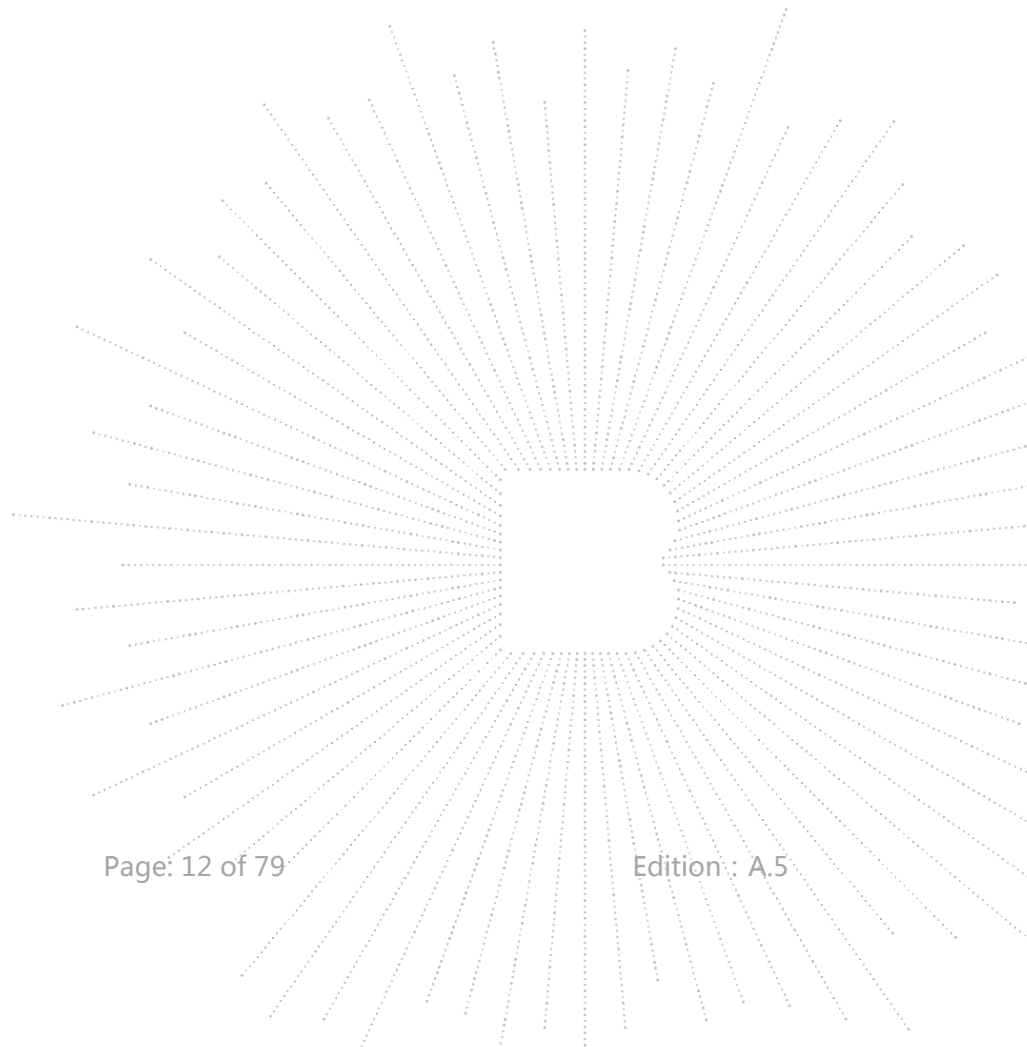

7. Nominal Centre frequencies

7.1 Block Diagram Of Test Setup

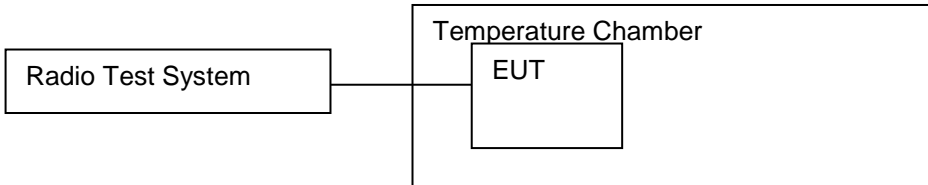

7.2 Limit

The Nominal Centre Frequencies (f_c) for a Nominal Channel Bandwidth of 20 MHz are defined by equation (1). See also figure 3.

$f_c = 5\,160 + (g \times 20)$ MHz, where $0 \leq g \leq 9$ or $16 \leq g \leq 27$ and where g shall be an integer.

A maximum offset of the Nominal Centre Frequency of ± 200 kHz is permitted. Where the manufacturer decides to make use of this frequency offset, the manufacturer shall declare the actual centre frequencies used by the equipment.

See clause 5.4.1, item a).

The actual centre frequency for any given channel shall be maintained within the range $f_c \pm 20$ ppm.

Equipment may have simultaneous transmissions on more than one Operating Channel with a Nominal Channel Bandwidth of 20 MHz.

7.3 Test procedure

This method is an alternative to the above method in case the UUT cannot be operated in an un-modulated mode.

The UUT shall be connected to spectrum analyser.

Max Hold shall be selected and the centre frequency adjusted to that of the UUT.

The peak value of the power envelope shall be measured and noted. The span shall be reduced and the marker moved in a positive frequency increment until the upper, (relative to the centre frequency), -10 dBc point is reached. This value shall be noted as f_1 .

The marker shall then be moved in a negative frequency increment until the lower, (relative to the centre frequency), -10 dBc point is reached. This value shall be noted as f_2 .

The centre frequency is calculated as $(f_1 + f_2) / 2$.

7.4 Test Result

Condition	Mode	Frequency (MHz)	Measured Frequency (MHz)	Frequency Error (Hz)	Deviation (ppm)	Limit (ppm)	Verdict
NVNT	a	5180	5179.98	-20000	-3.86	20	Pass
NVNT	a	5200	5199.98	-20000	-3.85	20	Pass
NVNT	a	5240	5239.98	-20000	-3.82	20	Pass
NVNT	n40	5190	5190	0	0	20	Pass
NVNT	n40	5230	5230	0	0	20	Pass
NVNT	ac80	5210	5210	0	0	20	Pass

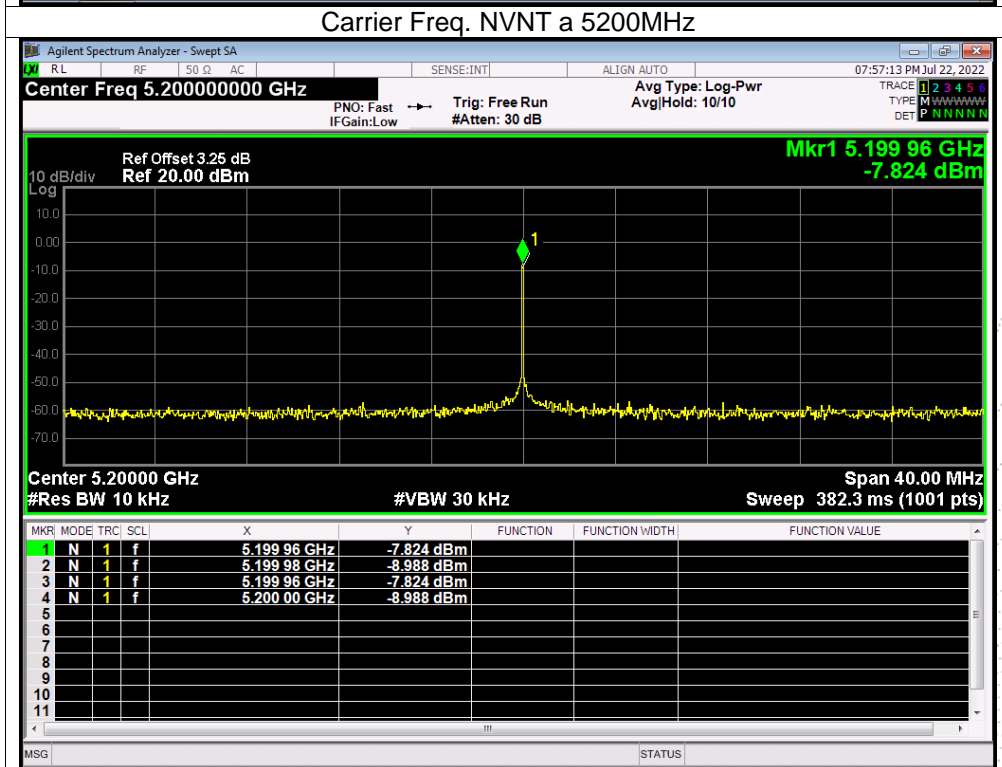
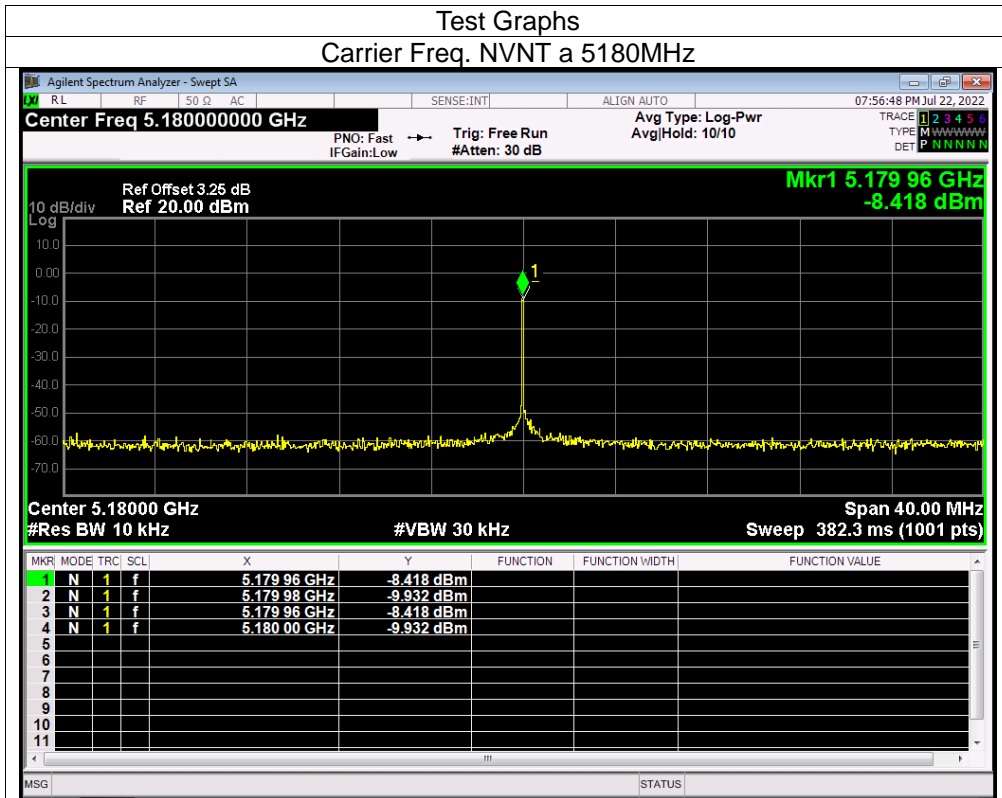

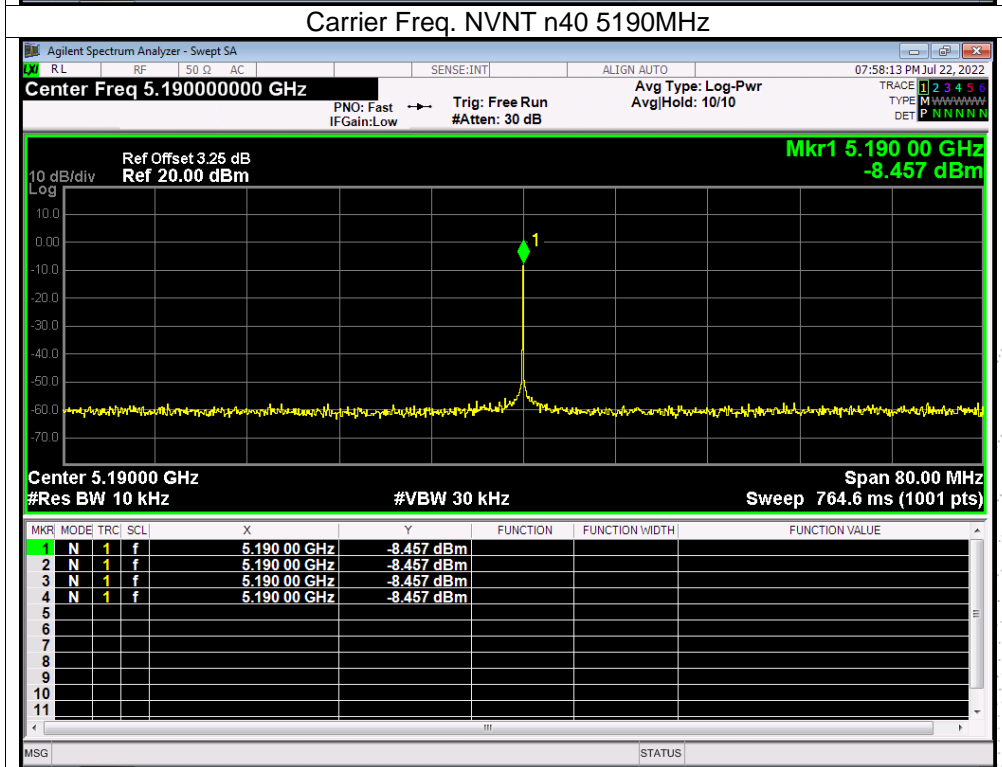
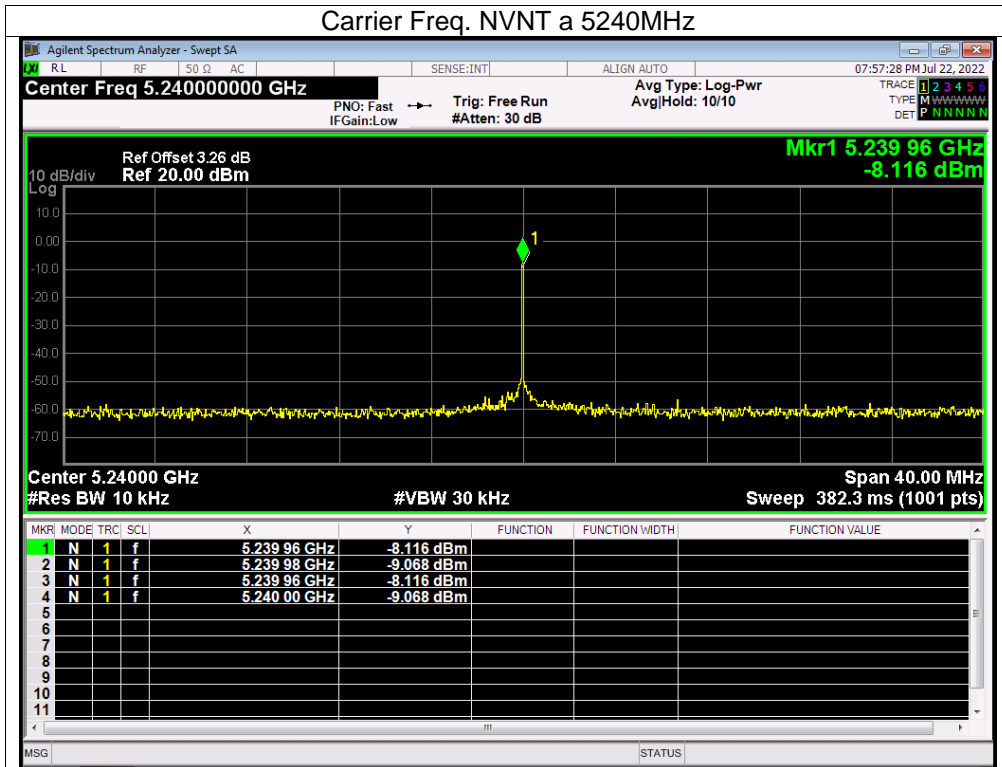

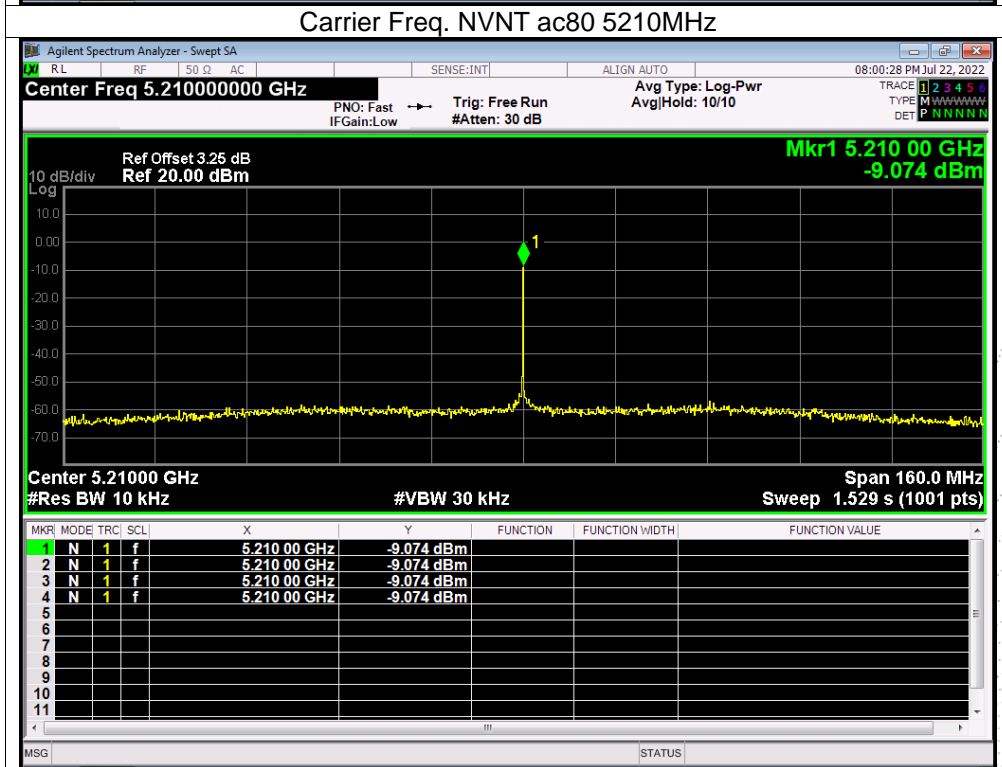
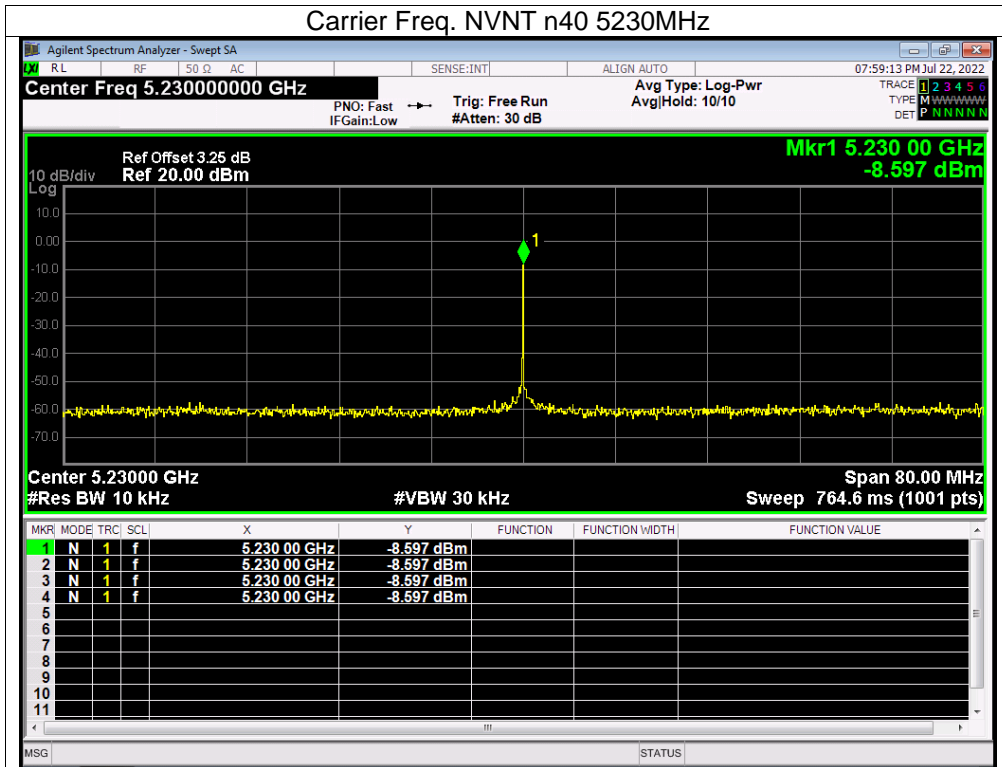

8. Nominal Channel Bandwidth and Occupied Channel Bandwidth

8.1 Block Diagram Of Test Setup

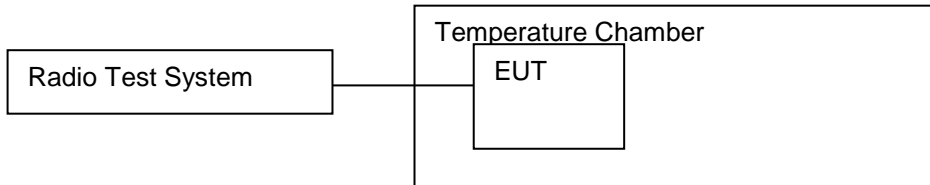

8.2 Limit

The Nominal Channel Bandwidth for a single Operating Channel shall be 20 MHz. Alternatively, equipment may implement a lower Nominal Channel Bandwidth with a minimum of 5 MHz, providing they still comply with the Nominal Centre Frequencies defined in clause 4.2.1 (20 MHz raster). The Occupied Channel Bandwidth shall be between 80 % and 100 % of the Nominal Channel Bandwidth. In case of smart antenna systems (devices with multiple transmit chains) each of the transmit chains shall meet this requirement. The Occupied Channel Bandwidth might change with time/payload.

8.3 Test procedure

Step 1:

- Connect the UUT to the spectrum analyser and use the following settings:
 - Centre Frequency: The centre frequency of the channel under test
 - Resolution Bandwidth: 100 kHz
 - Video Bandwidth: 300 kHz
 - Frequency Span: 2 × Nominal Bandwidth (e.g. 40 MHz for a 20 MHz channel)
 - Sweep time: > 1 s; for larger Nominal Bandwidths, the sweep time may be increased until a value where the sweep time has no impact on the RMS value of the signal
 - Detector Mode: RMS
 - Trace Mode: Max Hold

Step 2:

- Wait for the trace to stabilize.

Step 3:

- Make sure that the power envelope is sufficiently above the noise floor of the analyser to avoid the noise signals left and right from the power envelope being taken into account by this measurement.
- Use the 99 % bandwidth function of the spectrum analyser to measure the Occupied Channel Bandwidth of the UUT. This value shall be recorded.

The measurement described in step 1 to step 3 above shall be repeated in case of simultaneous transmissions in non-adjacent channels.

8.4 Test Result

Condition	Mode	Frequency (MHz)	Center Frequency (MHz)	OBW (MHz)	Verdict
NVNT	a	5180	5179.951	16.418	Pass
NVNT	a	5200	5199.944	16.410	Pass
NVNT	a	5240	5239.951	16.415	Pass
NVNT	n20	5180	5179.940	17.615	Pass
NVNT	n20	5200	5199.936	17.628	Pass
NVNT	n20	5240	5239.950	17.621	Pass
NVNT	n40	5190	5189.916	36.118	Pass
NVNT	n40	5230	5229.943	36.169	Pass
NVNT	ac20	5180	5179.939	17.623	Pass
NVNT	ac20	5200	5199.936	17.628	Pass
NVNT	ac20	5240	5239.951	17.616	Pass
NVNT	ac40	5190	5189.913	36.135	Pass
NVNT	ac40	5230	5229.940	36.168	Pass
NVNT	ac80	5210	5209.846	75.455	Pass

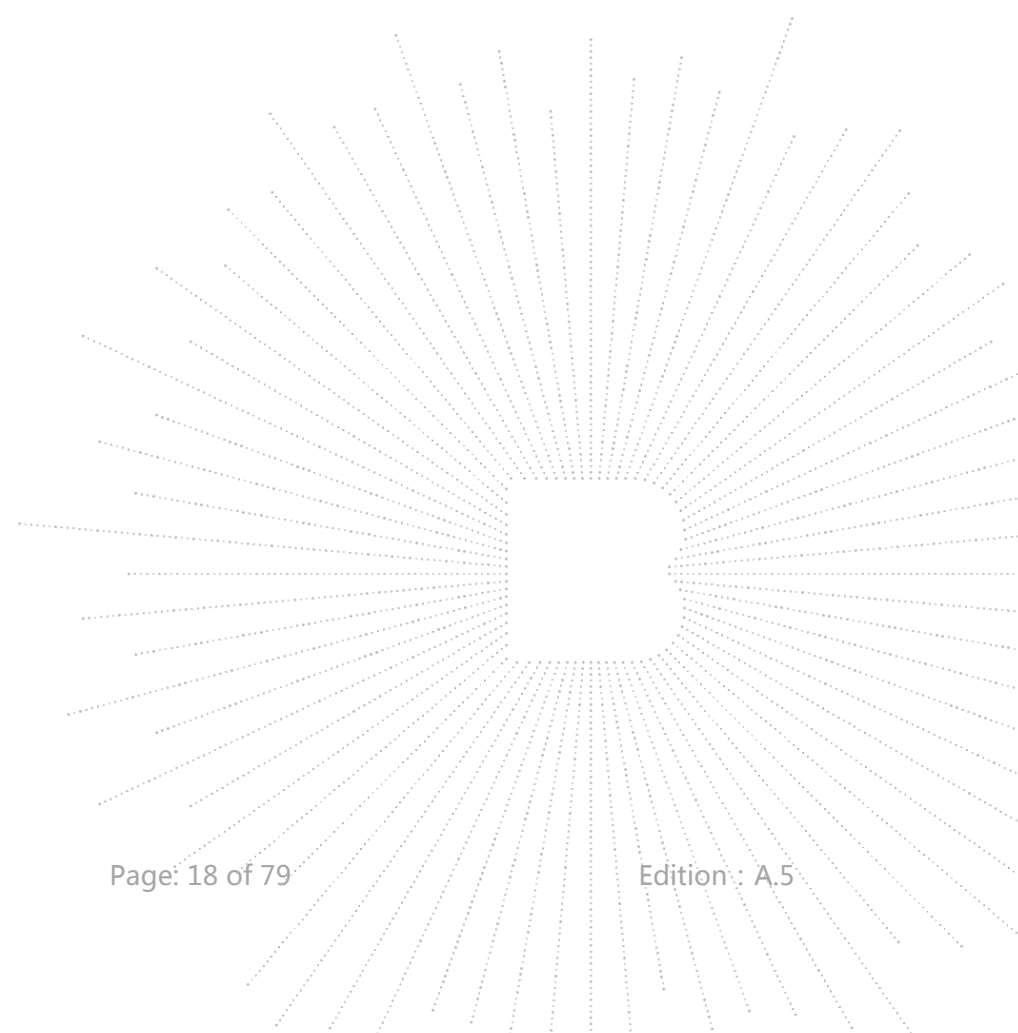

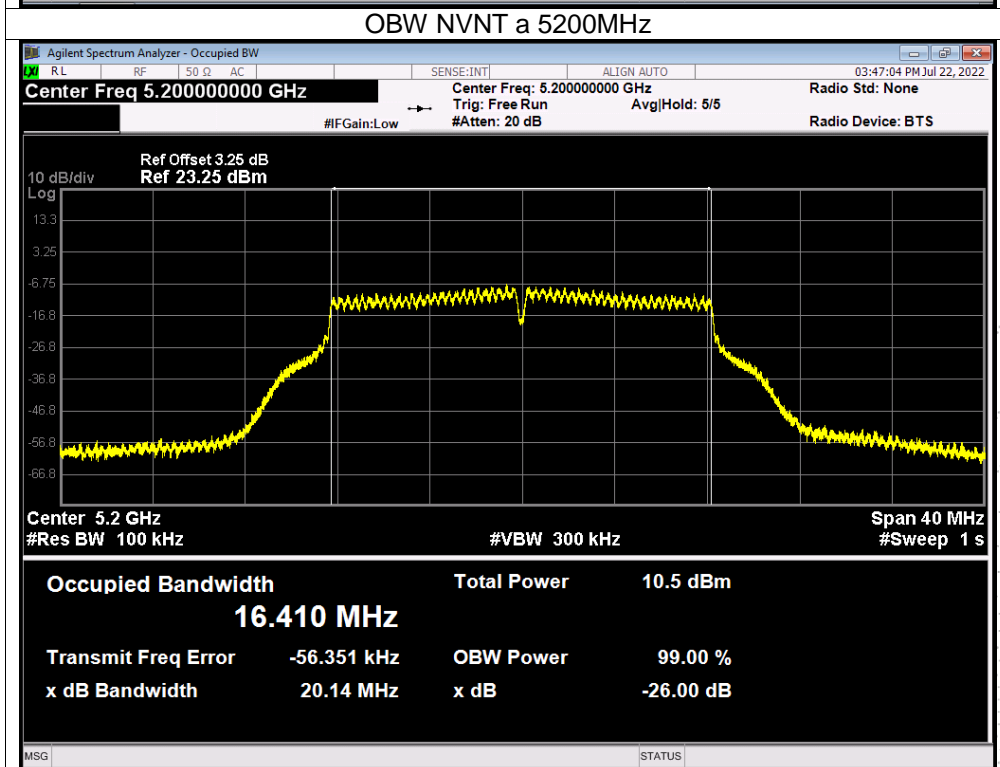
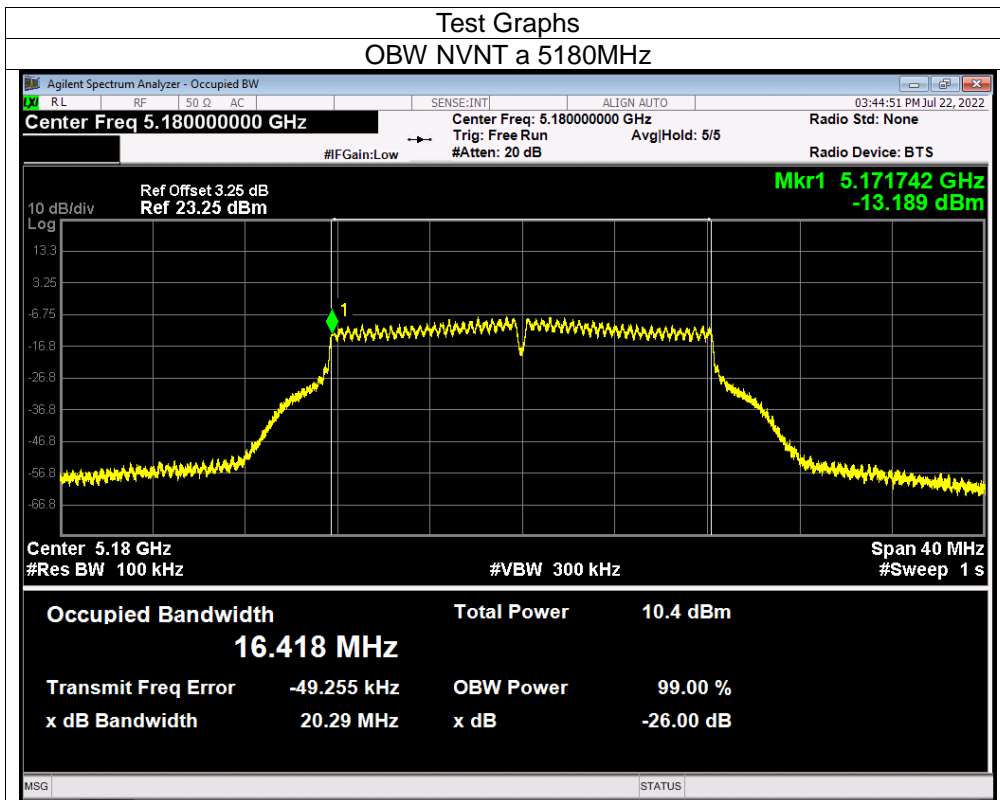

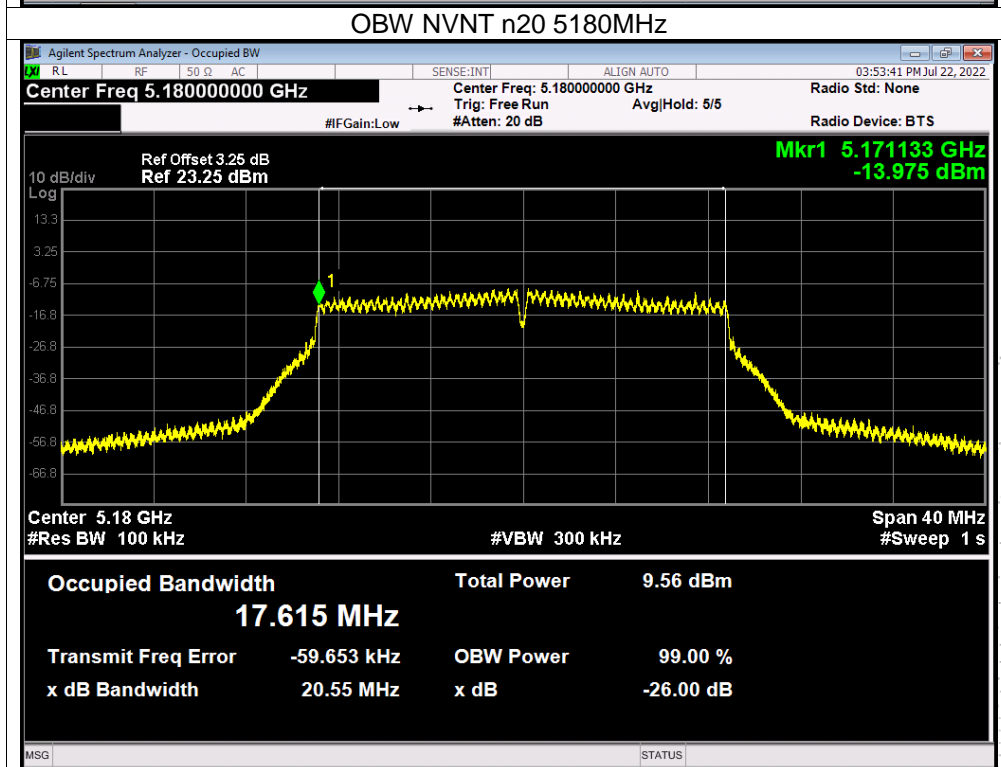
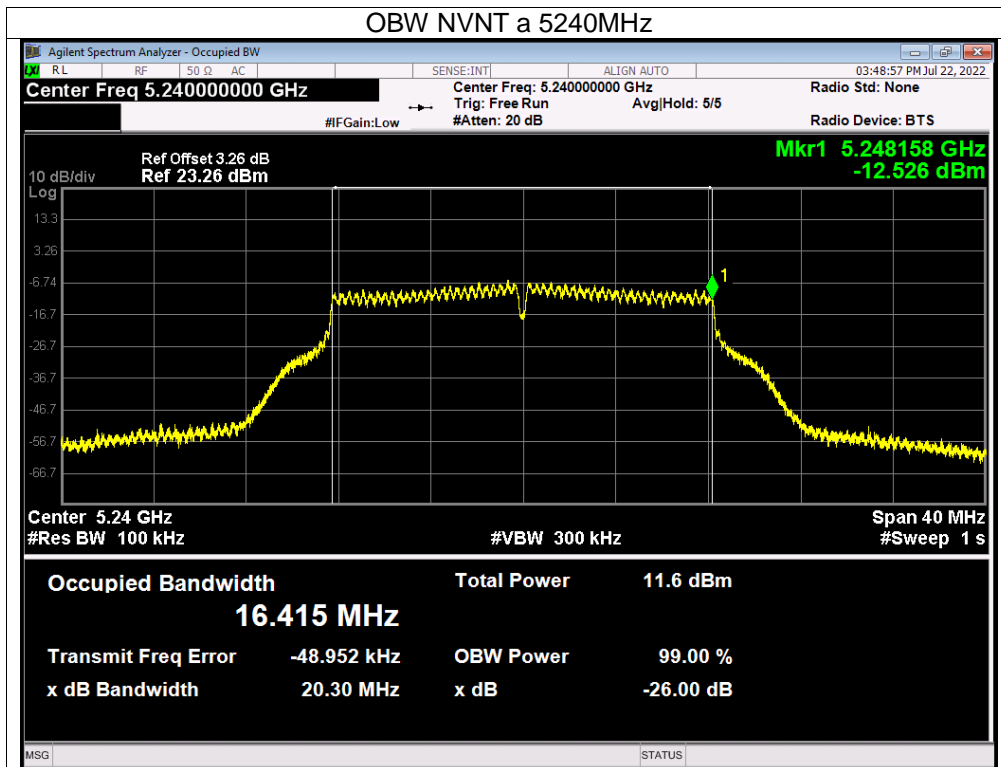

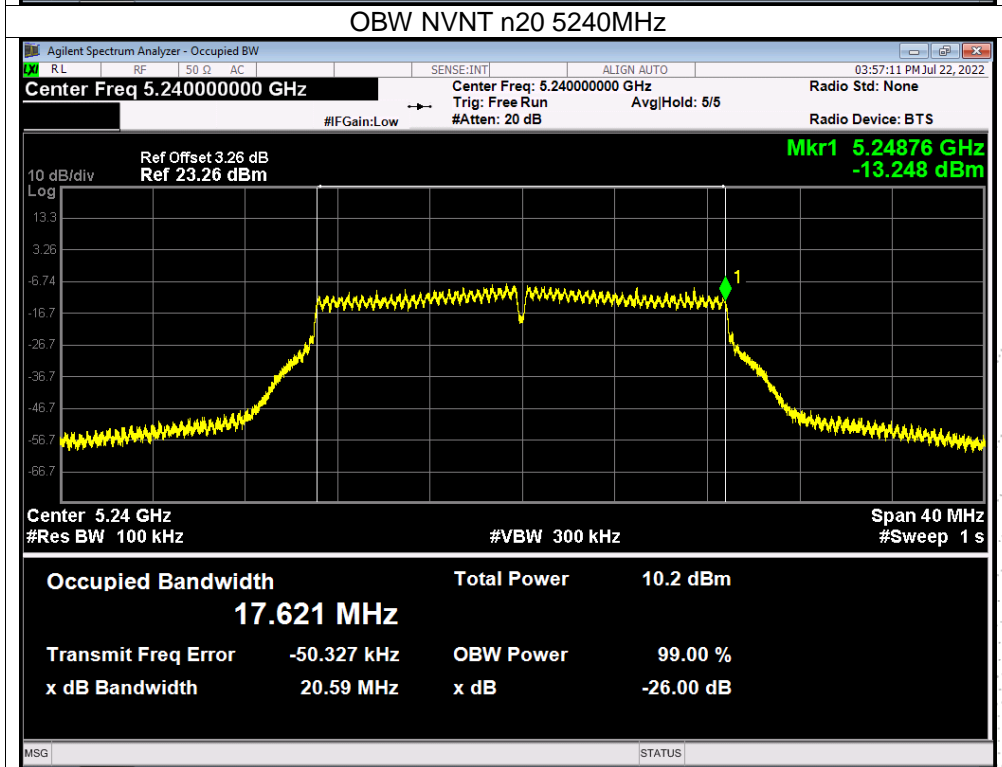
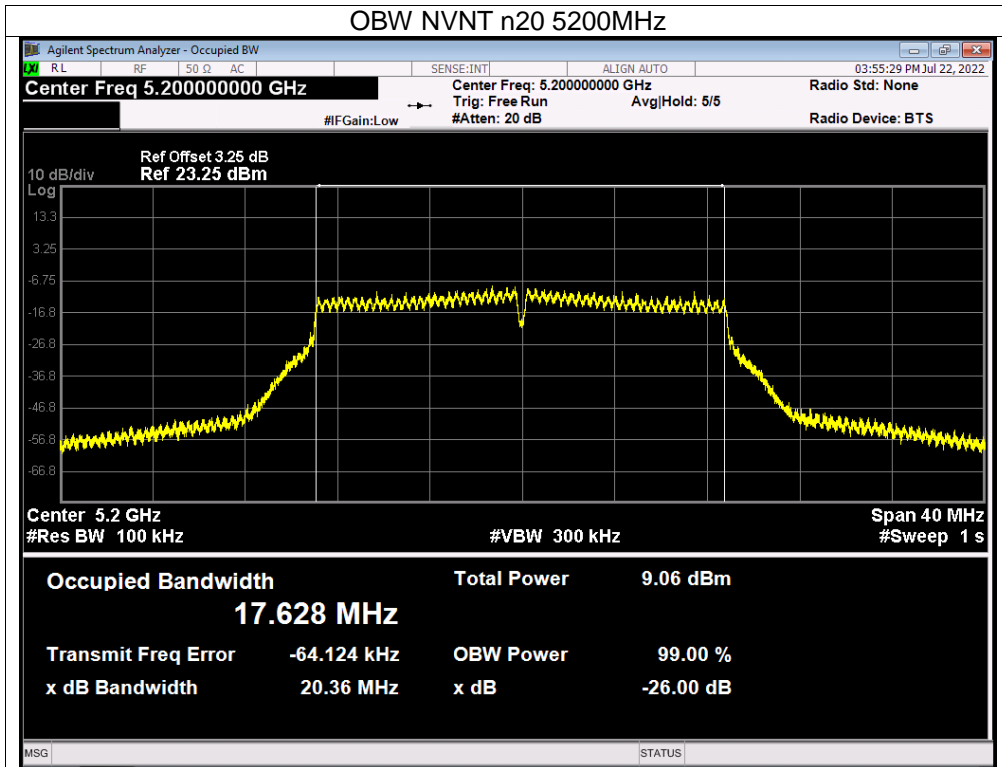

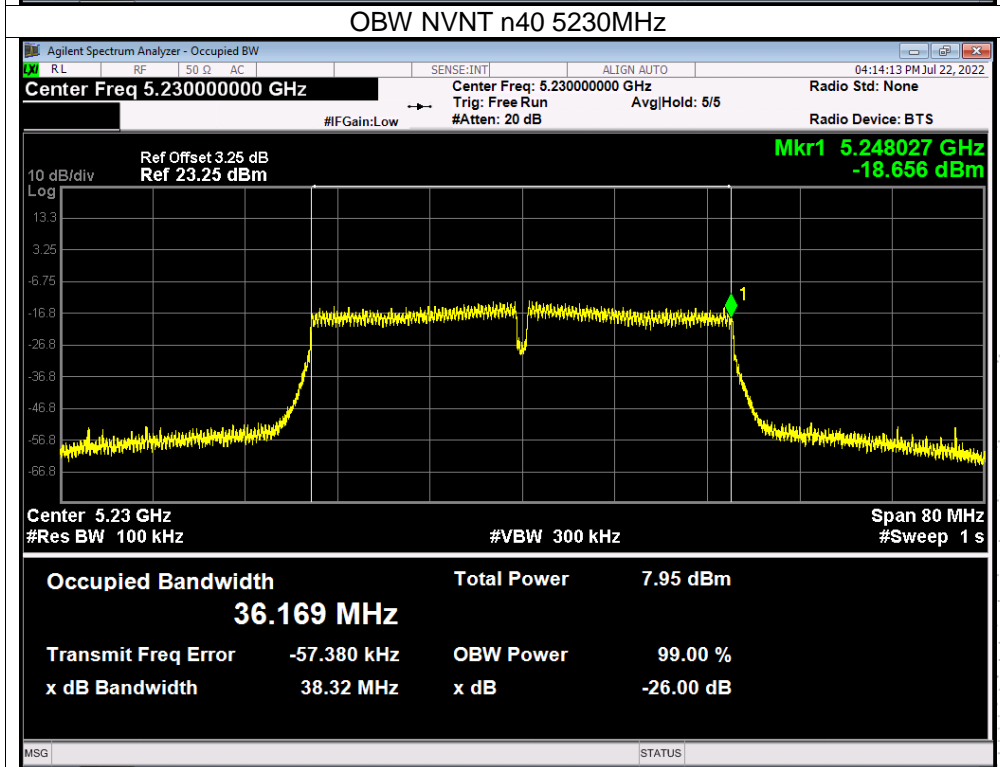
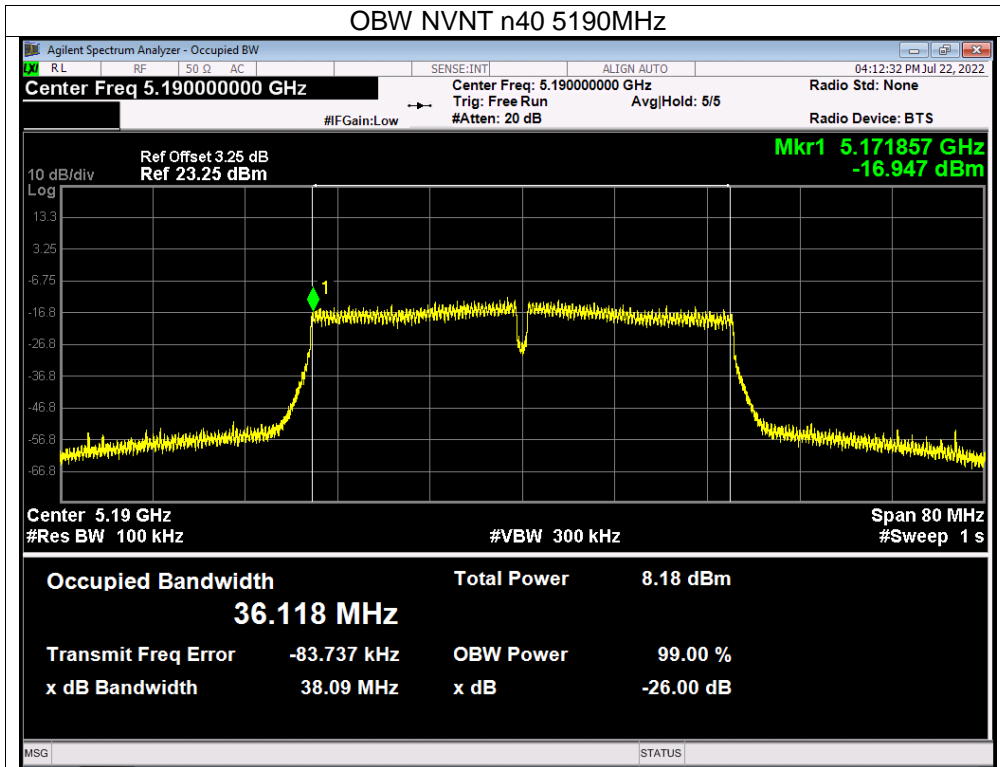

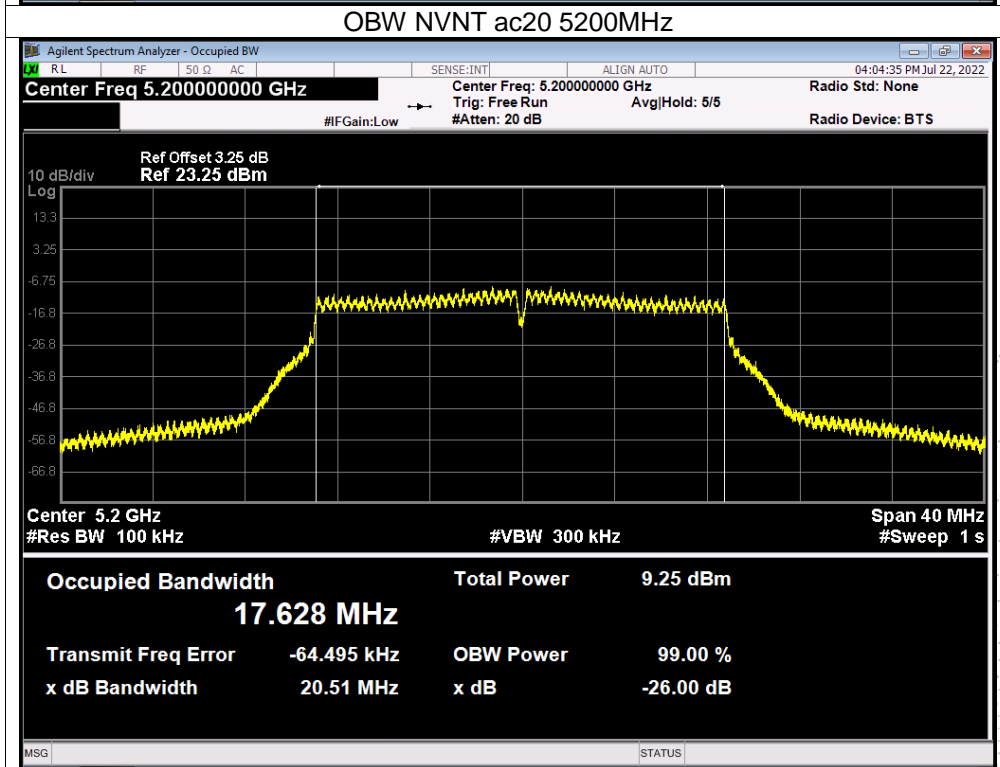
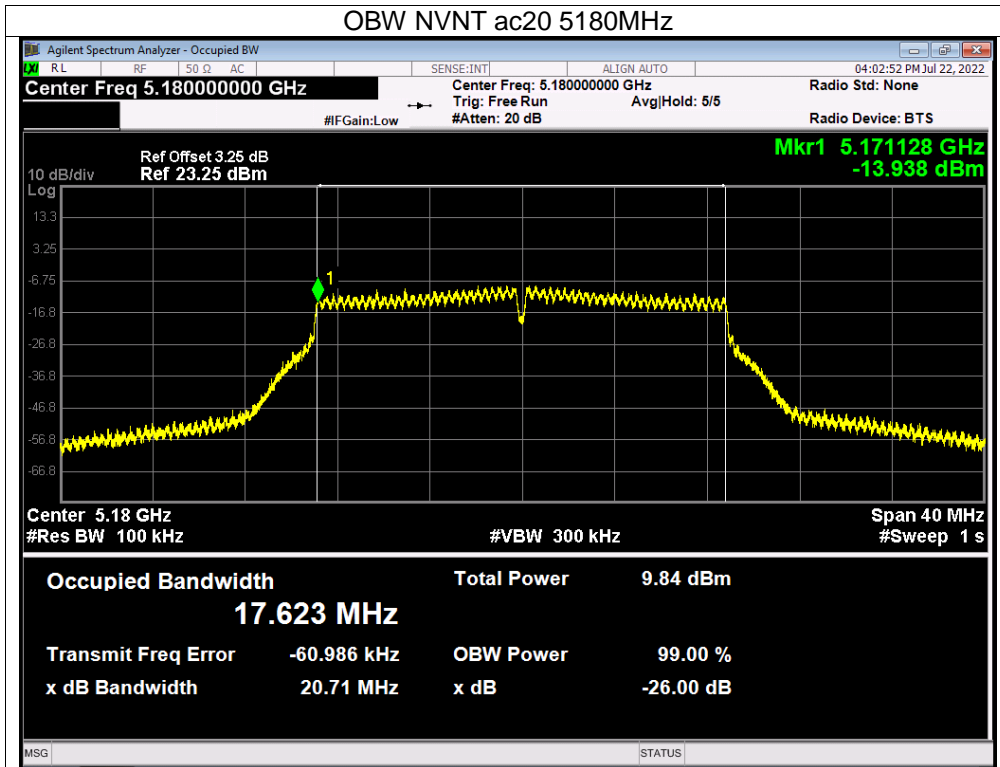

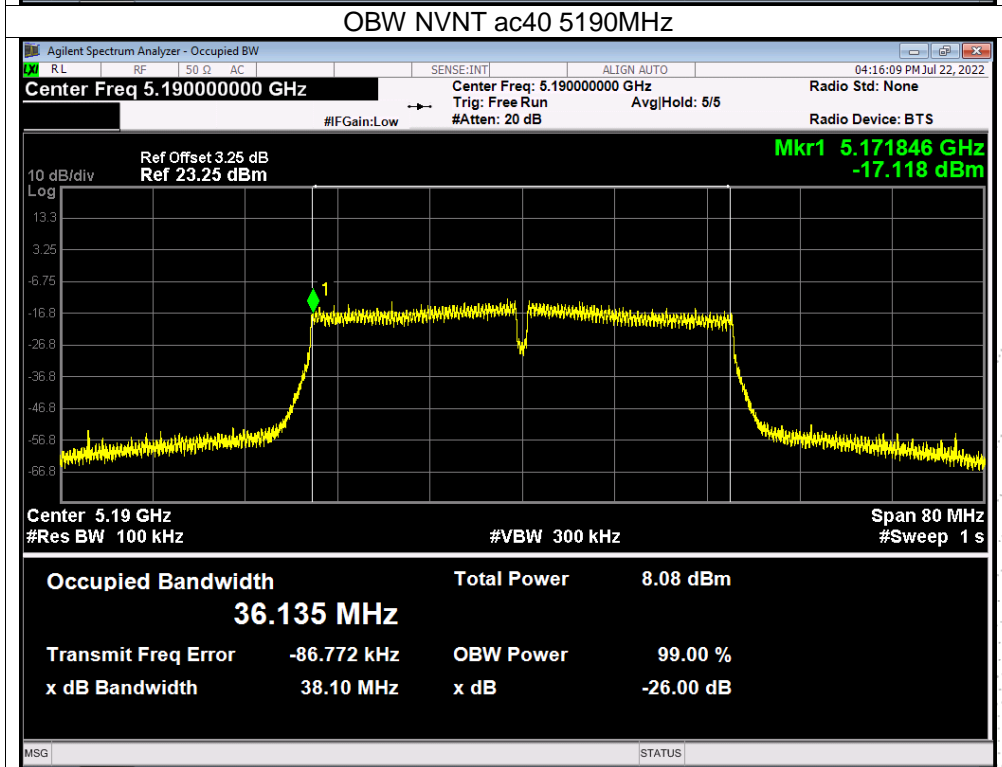
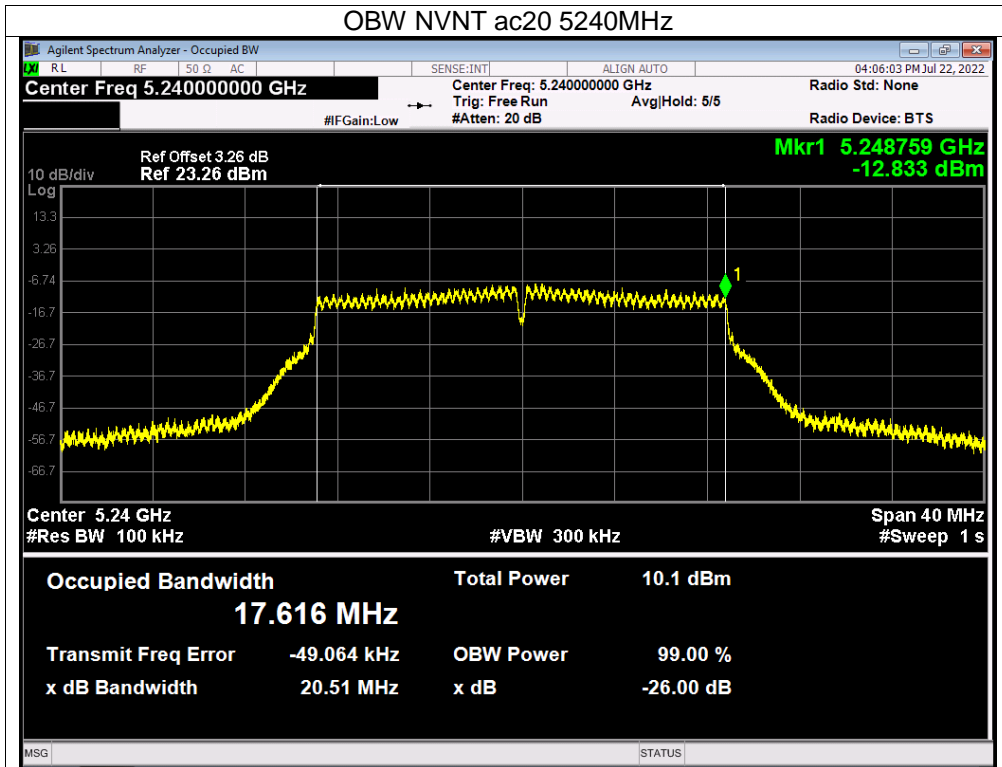

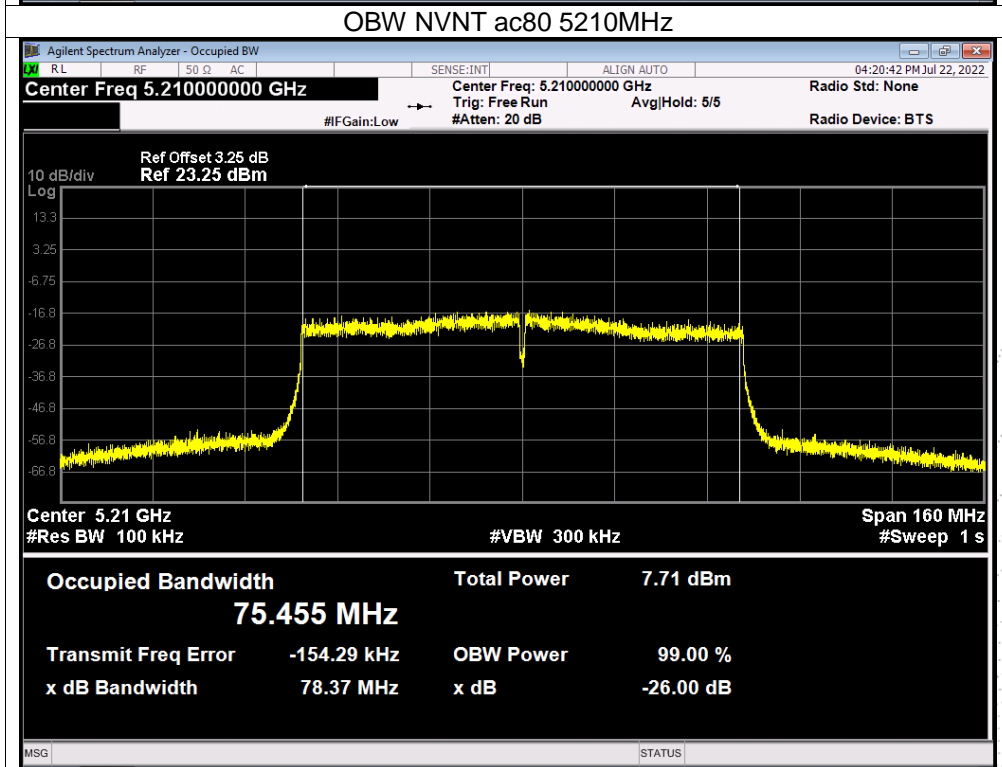
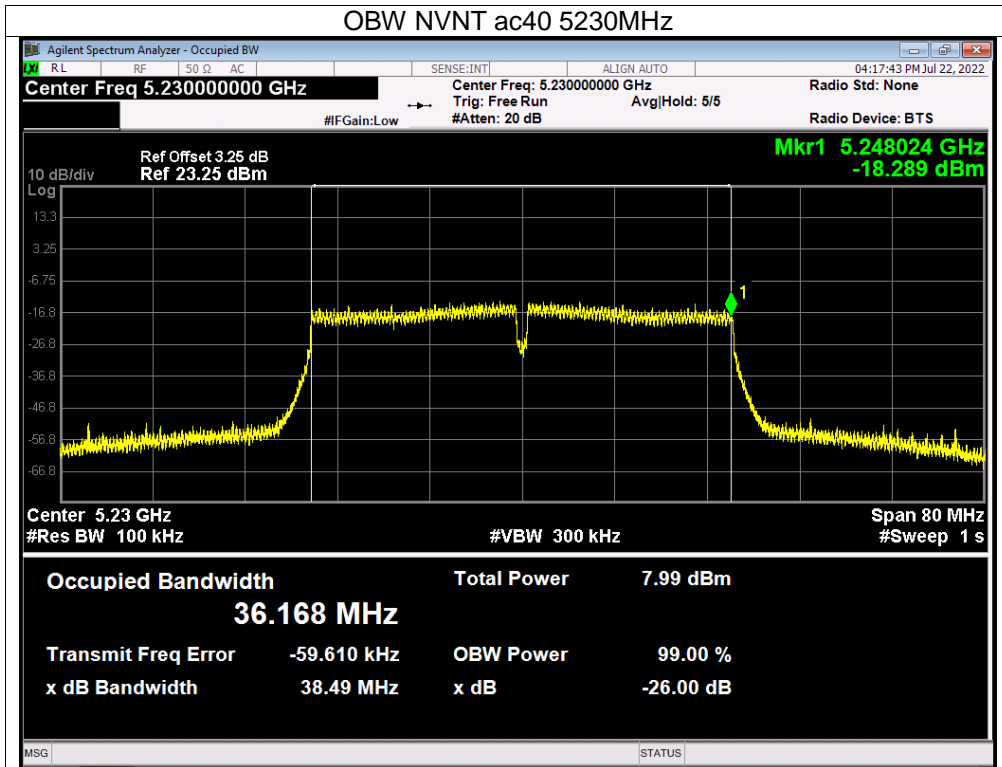

9. RF Output Power, Transmit Power Control (TPC)

9.1 Block Diagram Of Test Setup

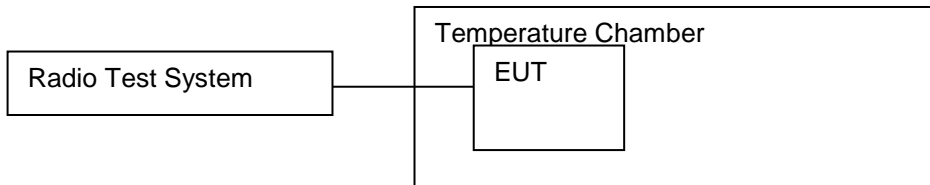

9.2 Limit

Frequency range (MHz)	Mean e.i.r.p. limit for P_H (dBm)		Mean e.i.r.p. density limit (dBm/MHz)	
	with TPC	without TPC	with TPC	without TPC
5 150 to 5 350	23	20/23 (see note 1)	10	7/10 (see note 2)
5 470 to 5 725	30 (see note 3)	27 (see note 3)	17 (see note 3)	14 (see note 3)

NOTE 1: The applicable limit is 20 dBm, except for transmissions whose nominal bandwidth falls completely within the band 5 150 MHz to 5 250 MHz, in which case the applicable limit is 23 dBm.

NOTE 2: The applicable limit is 7 dBm/MHz, except for transmissions whose nominal bandwidth falls completely within the band 5 150 MHz to 5 250 MHz, in which case the applicable limit is 10 dBm/MHz.

NOTE 3: Slave devices without a *Radar Interference Detection* function shall comply with the limits for the frequency range 5 250 MHz to 5 350 MHz.

9.3 Test procedure

This option is for equipment that operates only in one sub-band or that is capable for operation in two sub-bands simultaneously but, for the purpose of the testing, the equipment can be configured to:

- operate in a continuous transmit mode or with a constant duty cycle (x), and
- operate only in one sub-band.

Step 1:

For equipment configured into a continuous transmit mode ($x = 1$), proceed immediately with step 2.

- The output power of the transmitter shall be coupled to a matched diode detector or equivalent thereof. The output of the diode detector shall be connected to the vertical channel of an oscilloscope.
- The combination of the diode detector and the oscilloscope shall be capable of faithfully reproducing the duty cycle of the transmitter output signal.
- The observed duty cycle of the transmitter (Tx on / (Tx on + Tx off)) shall be noted as x ($0 < x \leq 1$), and recorded in the test report.

Step 2:

- The RF output power shall be determined using a wideband RF power meter with a thermocouple detector or an equivalent thereof and with an integration period that exceeds the repetition period of the transmitter by a factor 5 or more. The observed value shall be noted as A (in dBm).
- In case of conducted measurements on smart antenna systems operating in a mode with multiple transmit chains active simultaneously, the output power of each transmit chain shall be measured separately to calculate the total power (value A in dBm) for the UUT.

Step 3:

- The RF output power at the highest power level PH (e.i.r.p.) shall be calculated from the above measured power output A (in dBm), the observed duty cycle x, the stated antenna gain G in dBi and if applicable the beamforming gain Y in dB, according to the formula below. This value shall be recorded in the test report.

If more than one antenna assembly is intended for this power setting or TPC range, the gain of the antenna assembly with the highest gain shall be used.

$$PH = A + G + Y + 10 \times \log (1 / x) \text{ (dBm)}. (5)$$

- This value PH shall be compared to the applicable limit contained in table 2 of clause 4.2.3.2.2.

9.4 Test Result

Condition	Mode	Frequency (MHz)	Max Burst RMS Power (dBm)	Burst Number	Max EIRP (dBm)	Limit (dBm)	Verdict
NVNT	a	5180	8.85	67	10.85	23	Pass
	a	5200	9.22	67	11.22	23	Pass
	a	5240	9.86	68	11.86	23	Pass
	n20	5180	7.60	72	9.6	23	Pass
	n20	5200	7.73	72	9.73	23	Pass
	n20	5240	8.69	72	10.69	23	Pass
	n40	5190	6.03	134	8.03	23	Pass
	n40	5230	6.98	135	8.98	23	Pass
	ac20	5180	7.62	72	9.62	23	Pass
	ac20	5200	7.53	71	9.53	23	Pass
	ac20	5240	8.49	72	10.49	23	Pass
	ac40	5190	6.13	133	8.13	23	Pass
	ac40	5230	6.00	132	9	23	Pass
ac80	5210	6.18	235	8.18	23	Pass	
NVHT	a	5180	8.53	67	10.53	23	Pass
	a	5200	9.03	67	11.03	23	Pass
	a	5240	9.39	68	11.39	23	Pass
	n20	5180	7.31	72	9.31	23	Pass
	n20	5200	7.63	72	9.63	23	Pass
	n20	5240	8.46	72	10.46	23	Pass
	n40	5190	5.69	134	7.69	23	Pass
	n40	5230	6.96	135	8.96	23	Pass
	ac20	5180	7.29	72	9.29	23	Pass
	ac20	5200	7.40	71	9.40	23	Pass
	ac20	5240	8.41	72	10.41	23	Pass
	ac40	5190	5.67	133	7.67	23	Pass
	ac40	5230	6.80	132	8.80	23	Pass
ac80	5210	6.10	235	8.10	23	Pass	
NVLT	a	5180	8.31	67	10.31	23	Pass
	a	5200	8.66	67	10.66	23	Pass
	a	5240	9.08	68	11.08	23	Pass
	n20	5180	6.93	72	8.93	23	Pass
	n20	5200	7.33	72	9.33	23	Pass
	n20	5240	8.12	72	10.12	23	Pass
	n40	5190	5.38	134	7.38	23	Pass
	n40	5230	6.61	135	8.61	23	Pass
	ac20	5180	6.82	72	8.82	23	Pass
	ac20	5200	7.05	71	9.05	23	Pass
	ac20	5240	8.13	72	10.13	23	Pass
	ac40	5190	5.32	133	7.32	23	Pass
	ac40	5230	6.76	132	8.76	23	Pass
ac80	5210	5.71	235	7.71	23	Pass	

Test Graphs

Power NVNT a 5180MHz

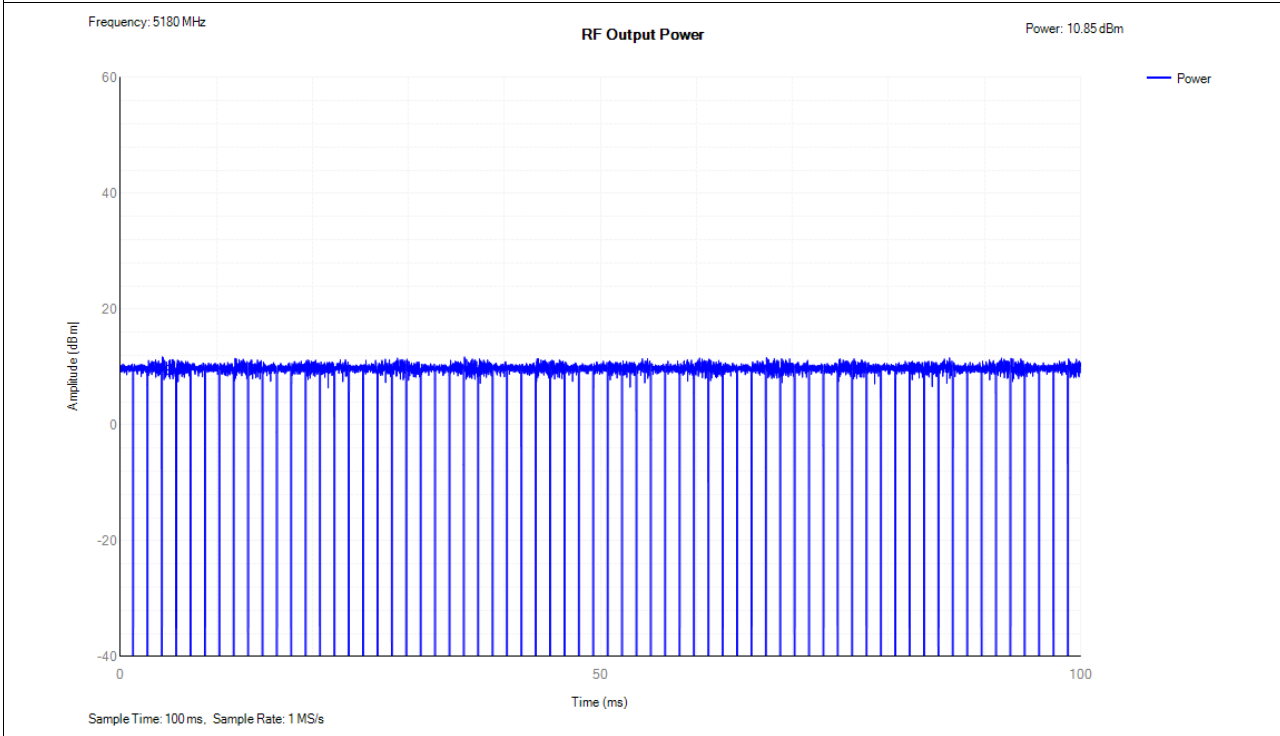

Power NVNT a 5200MHz

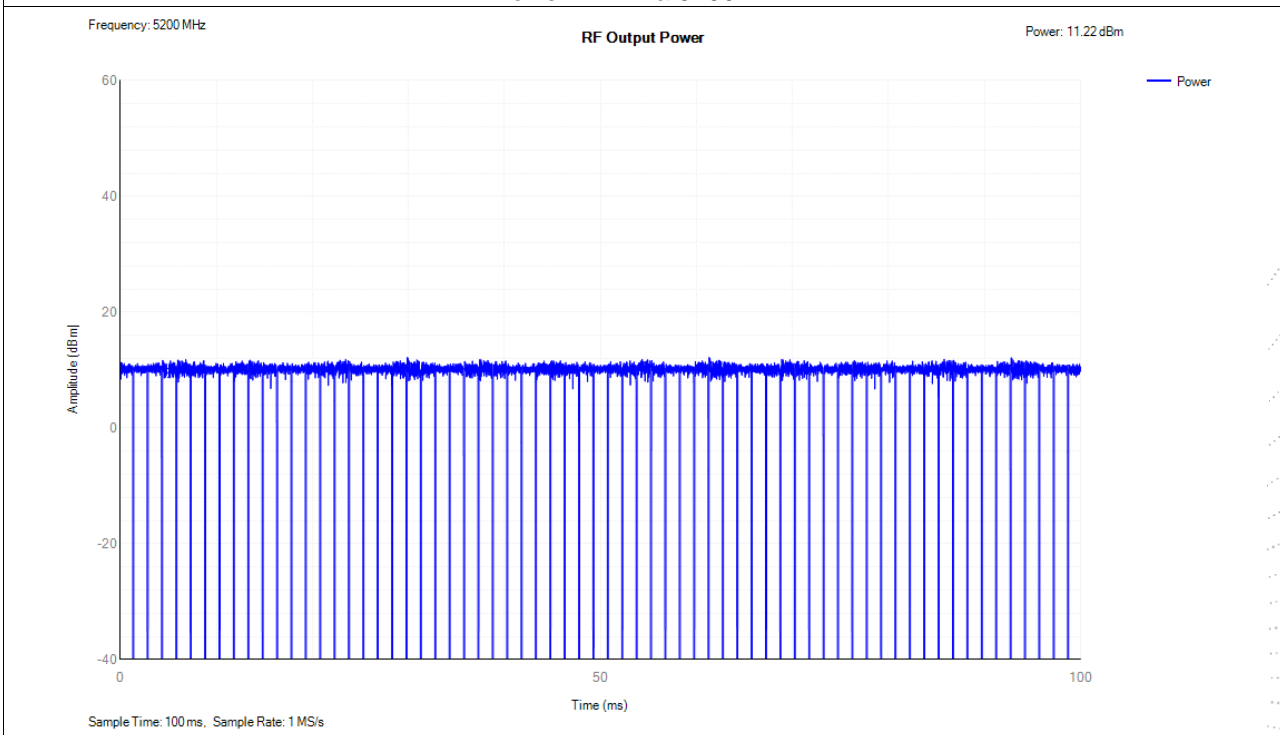

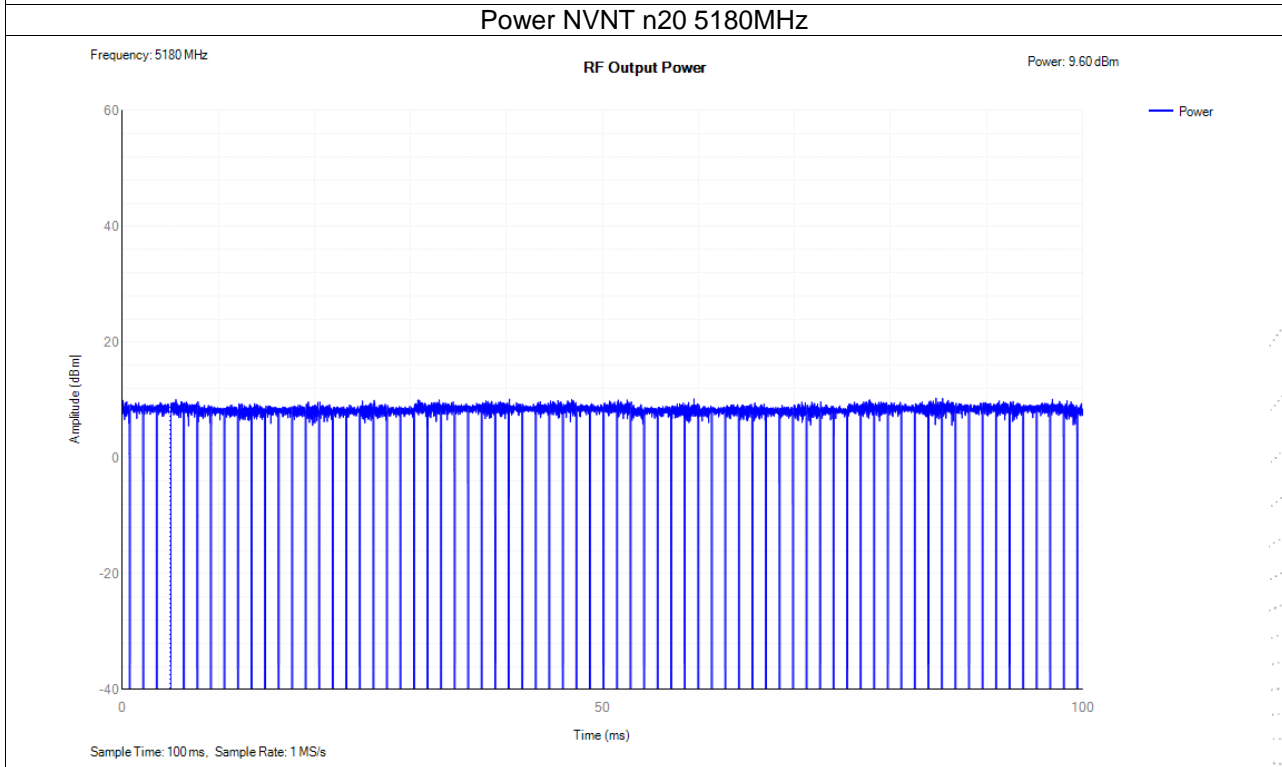
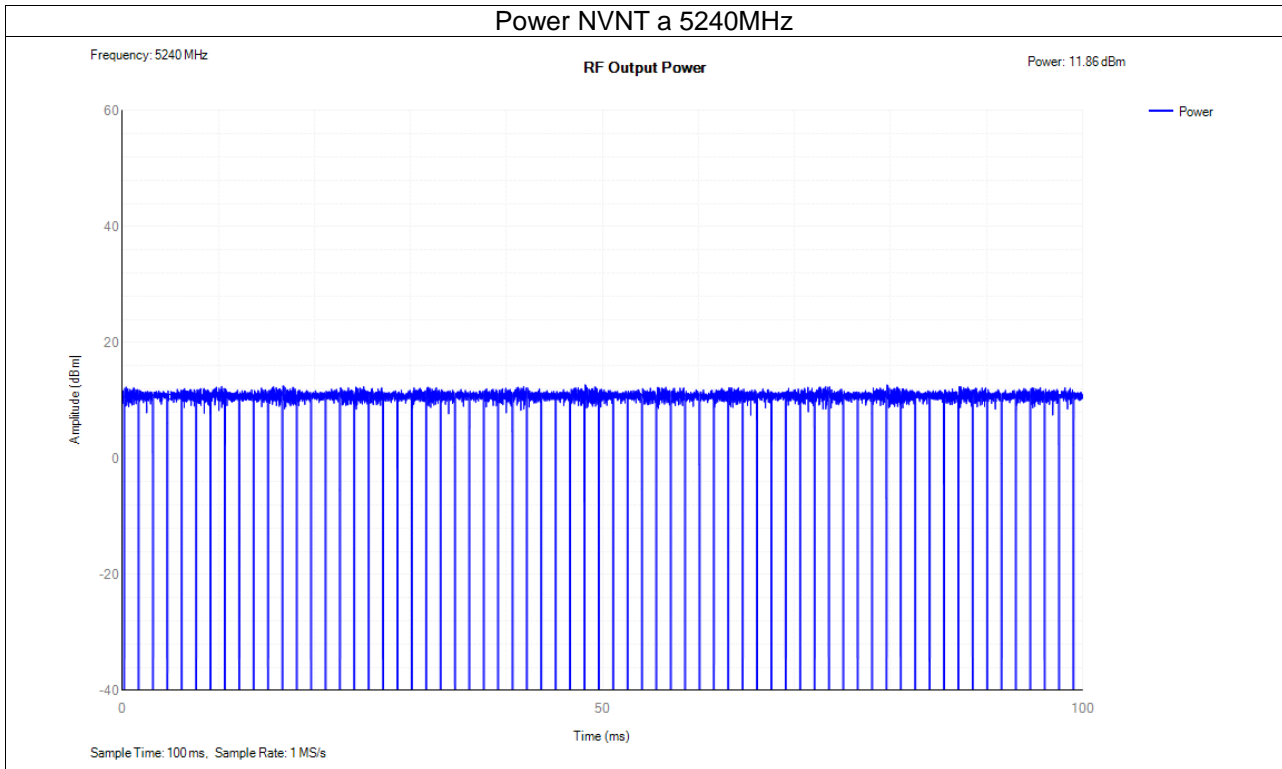

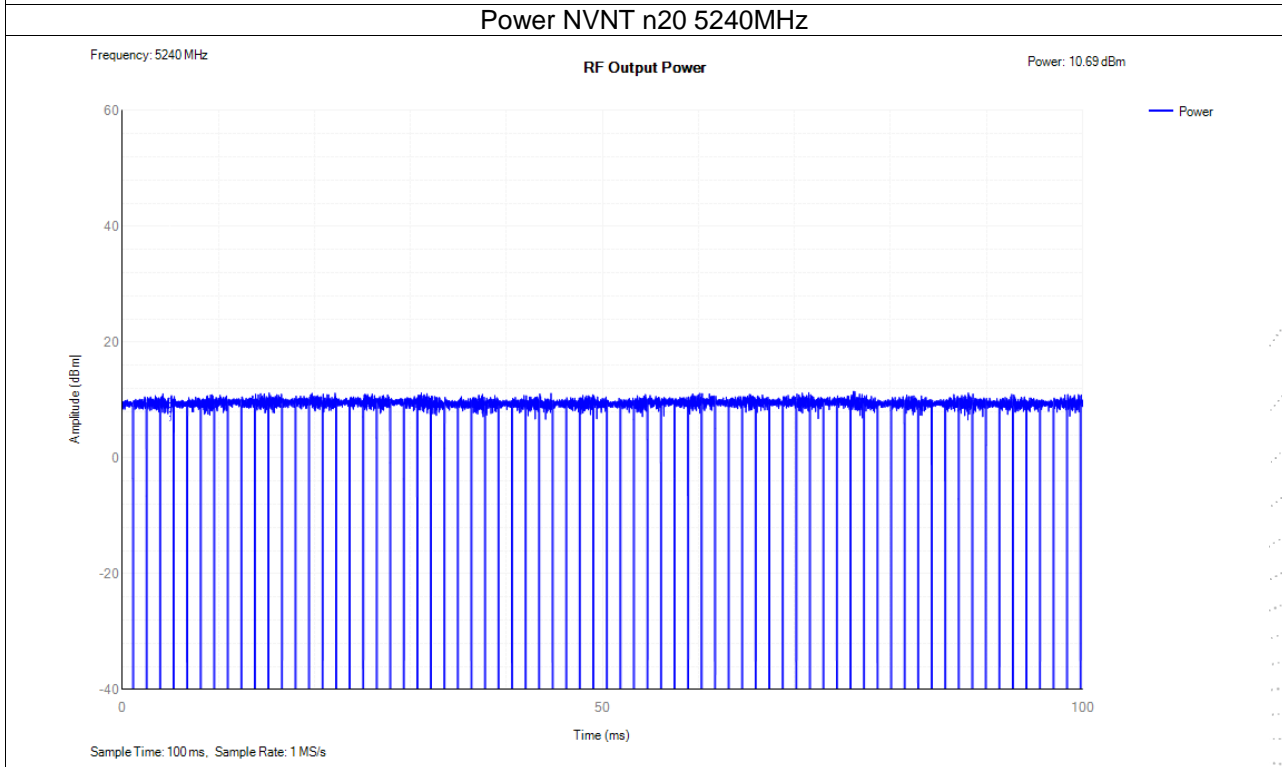
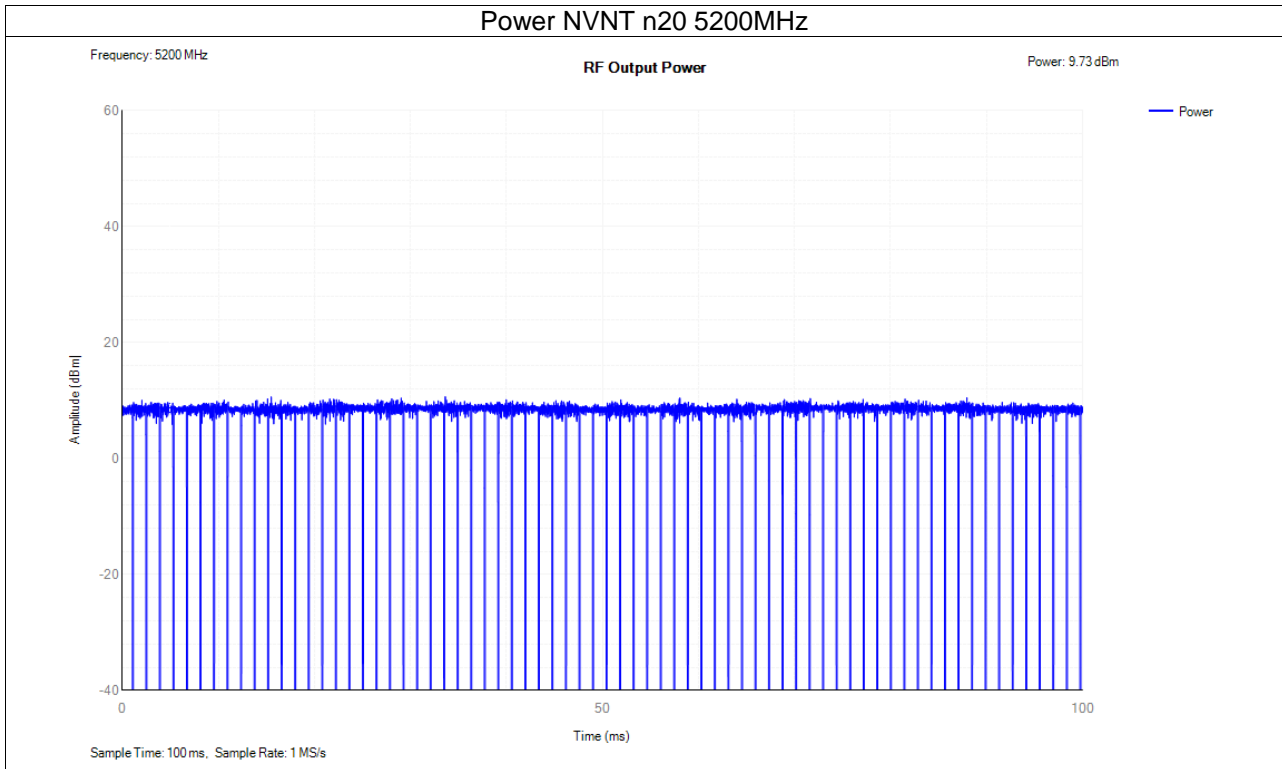

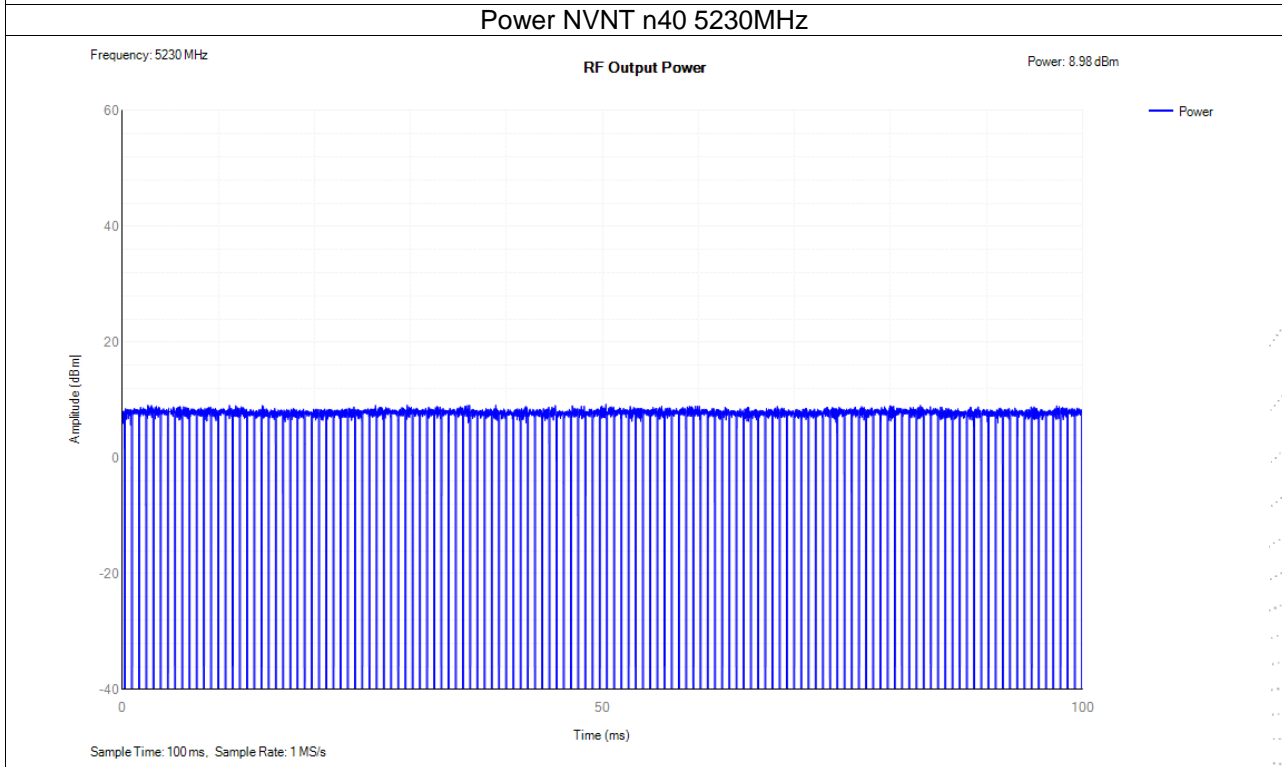
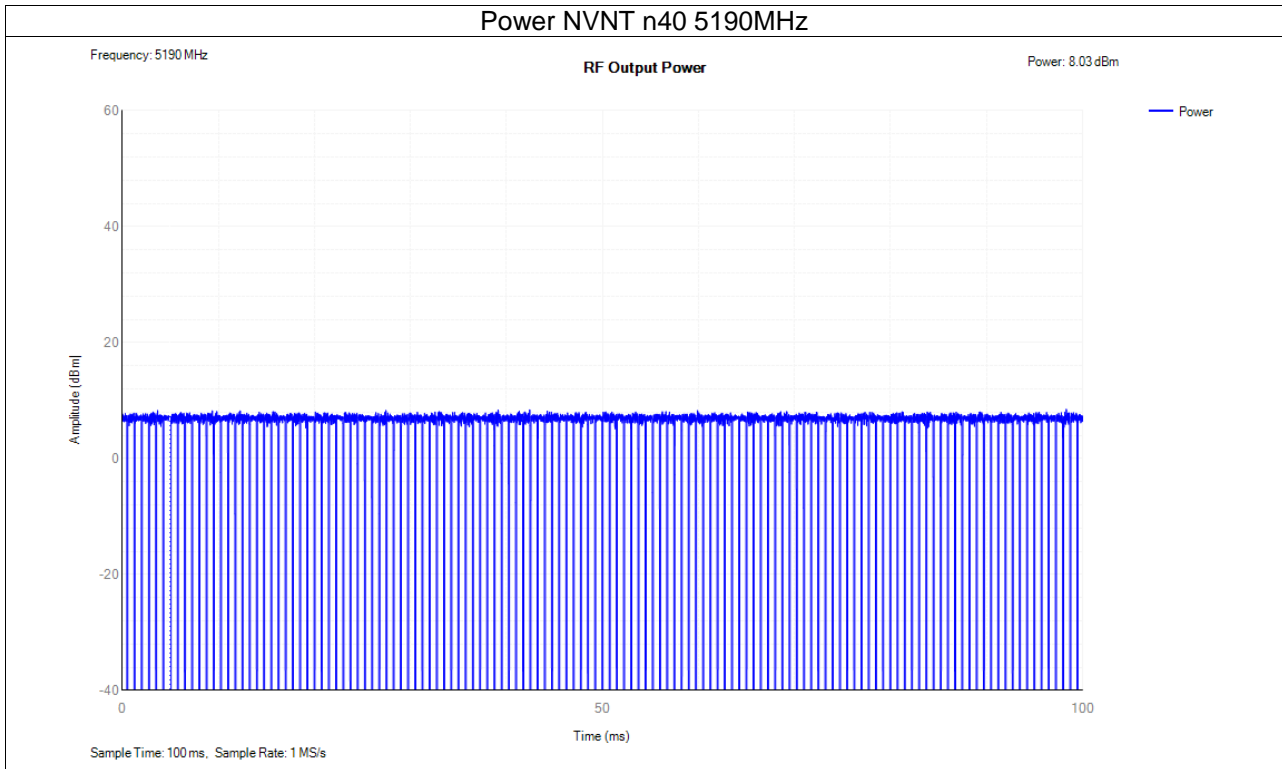

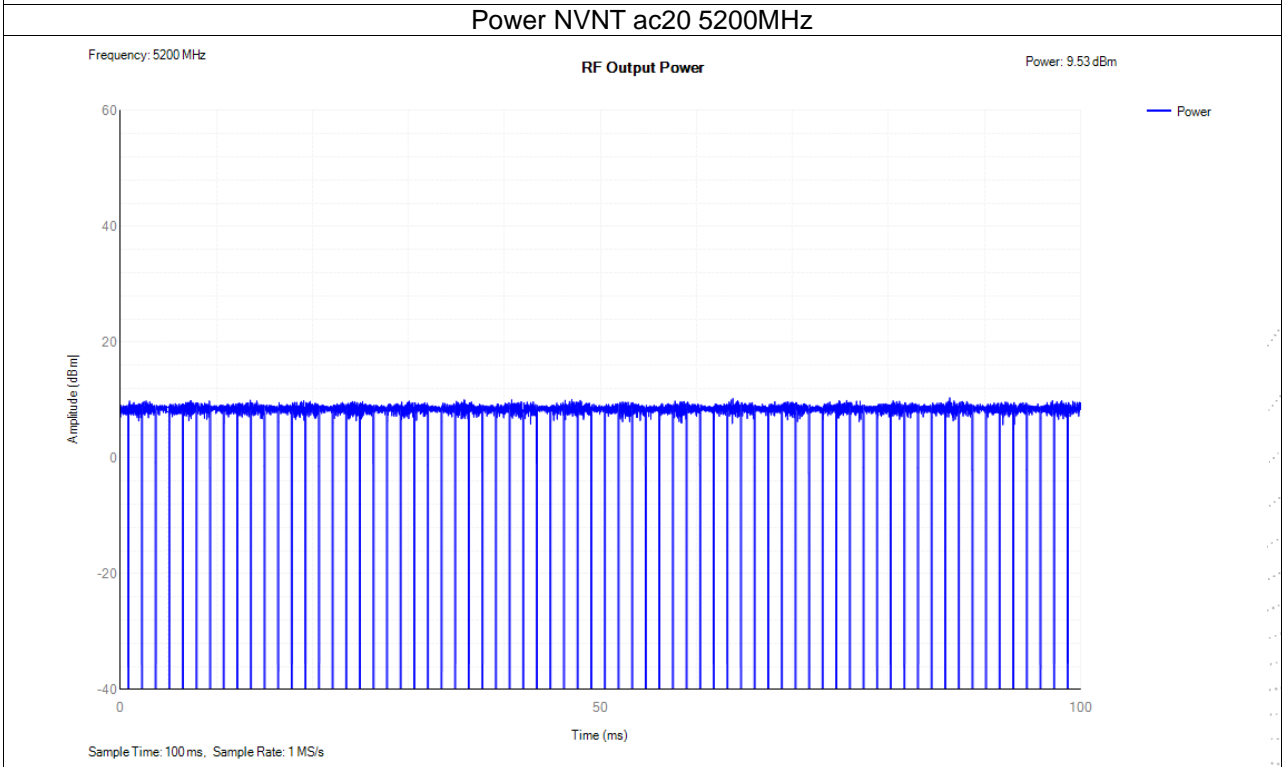
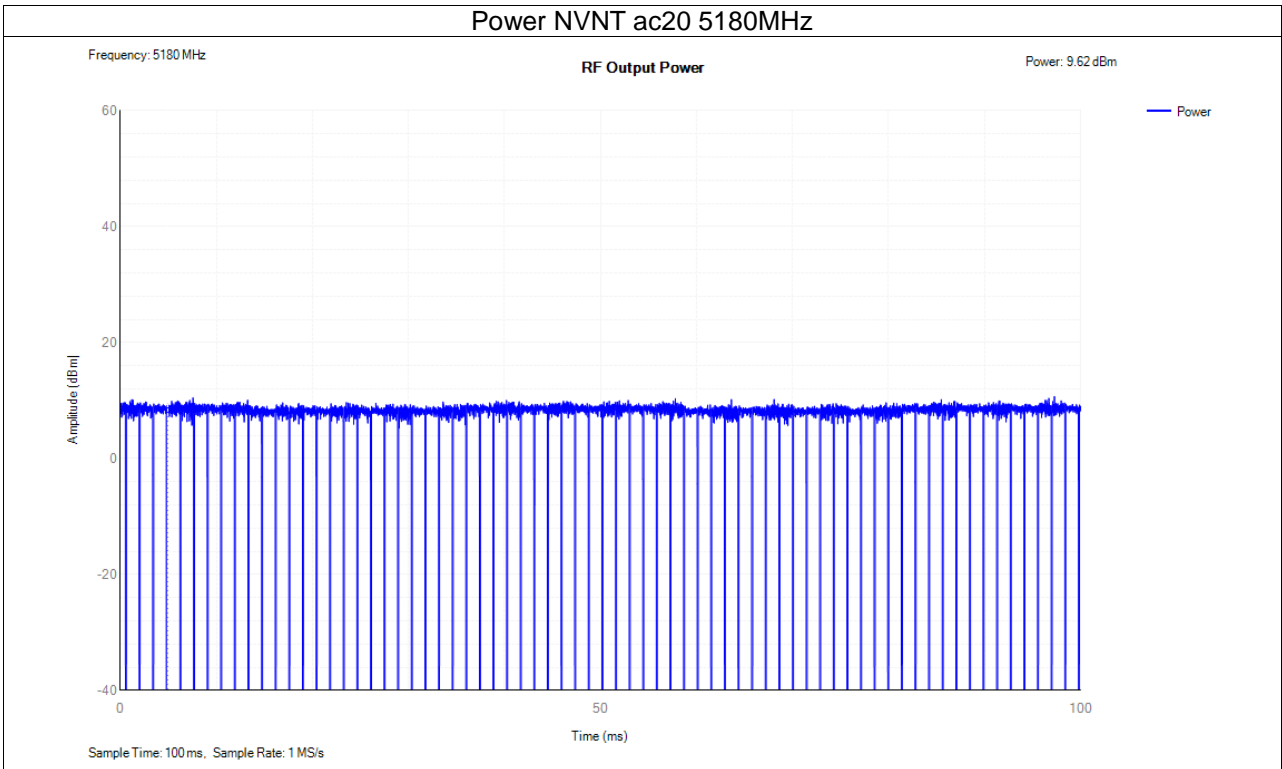

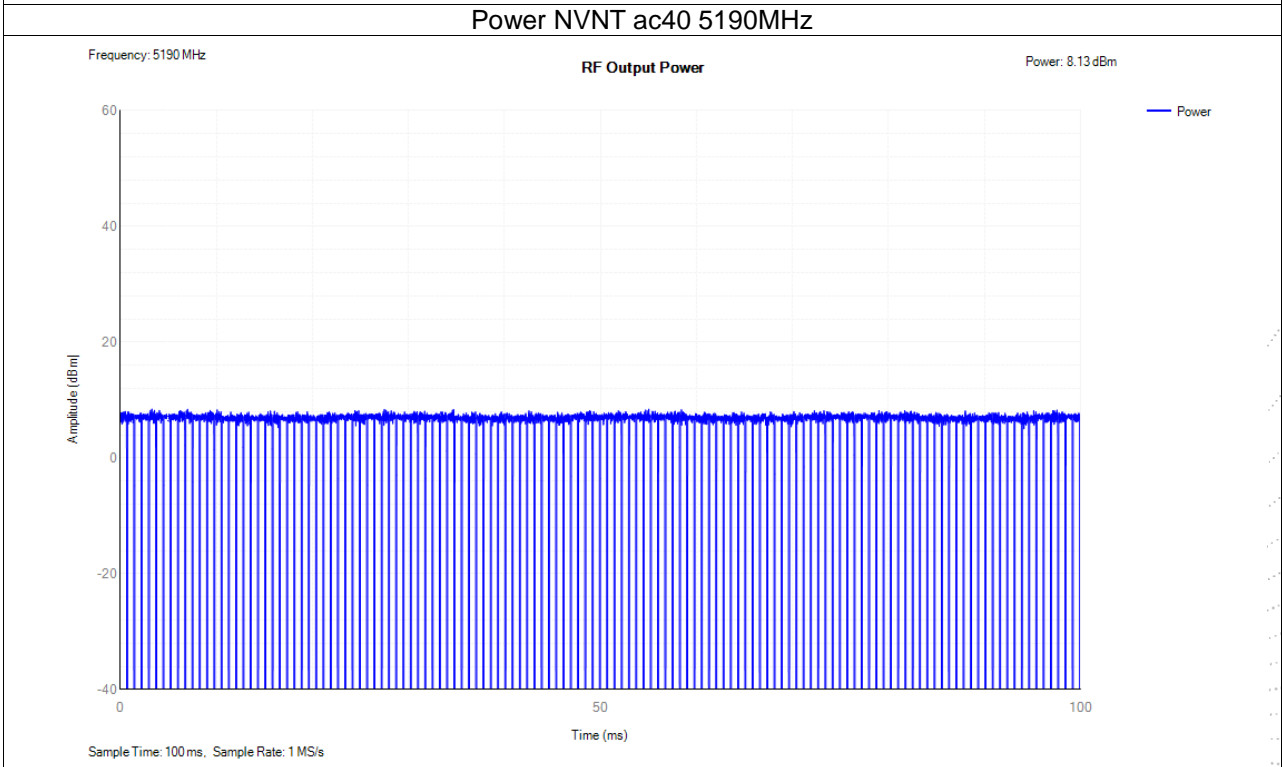
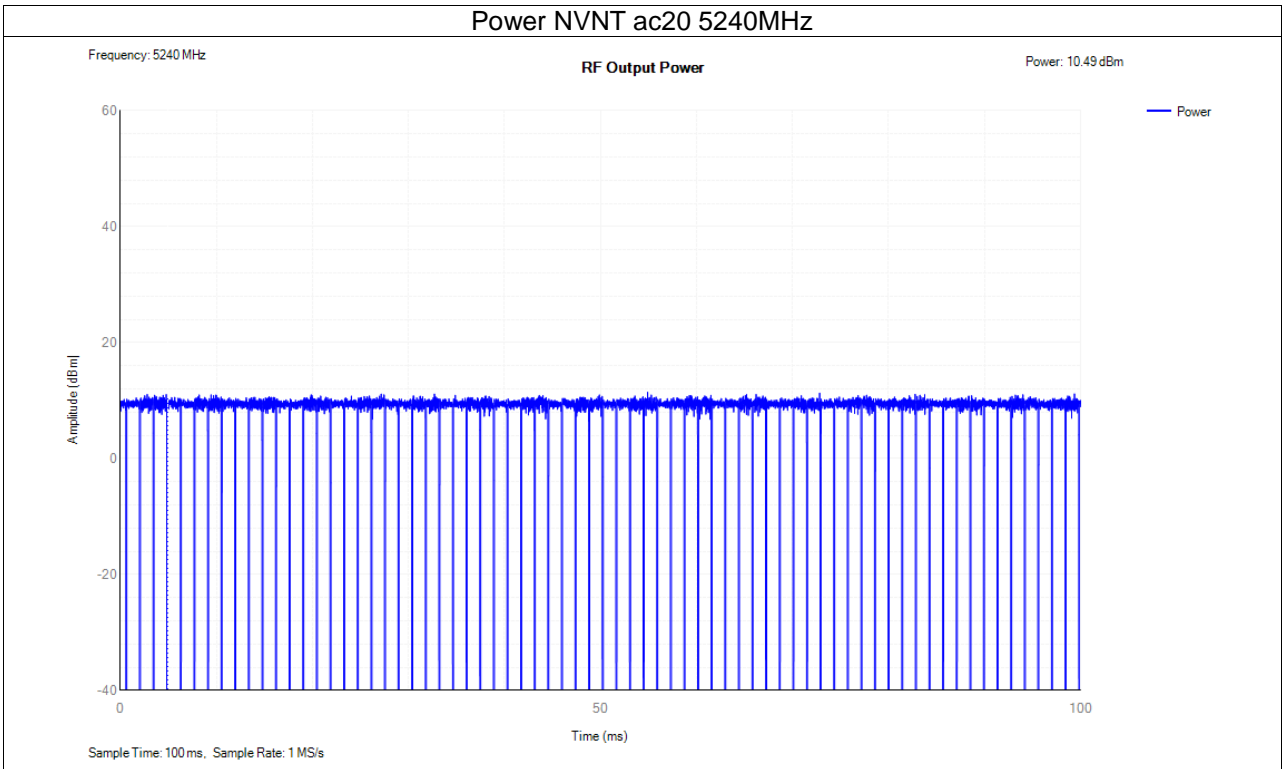

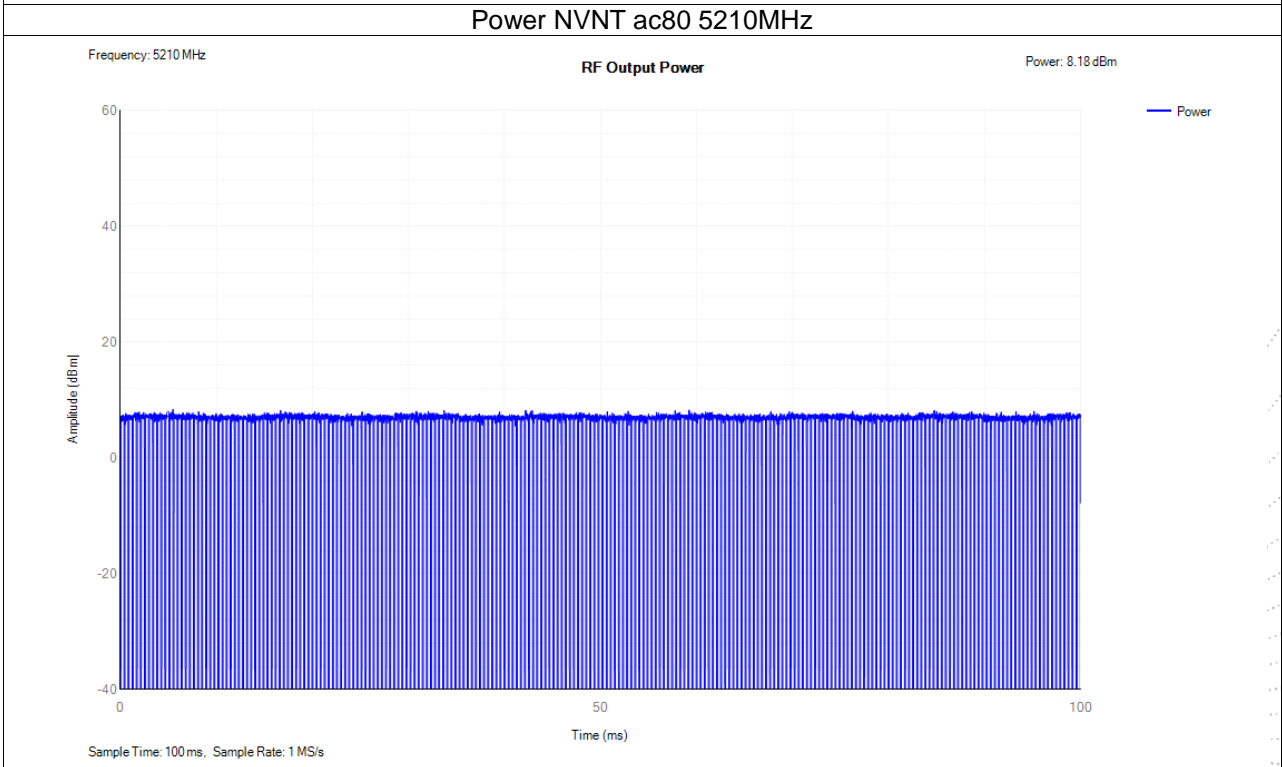
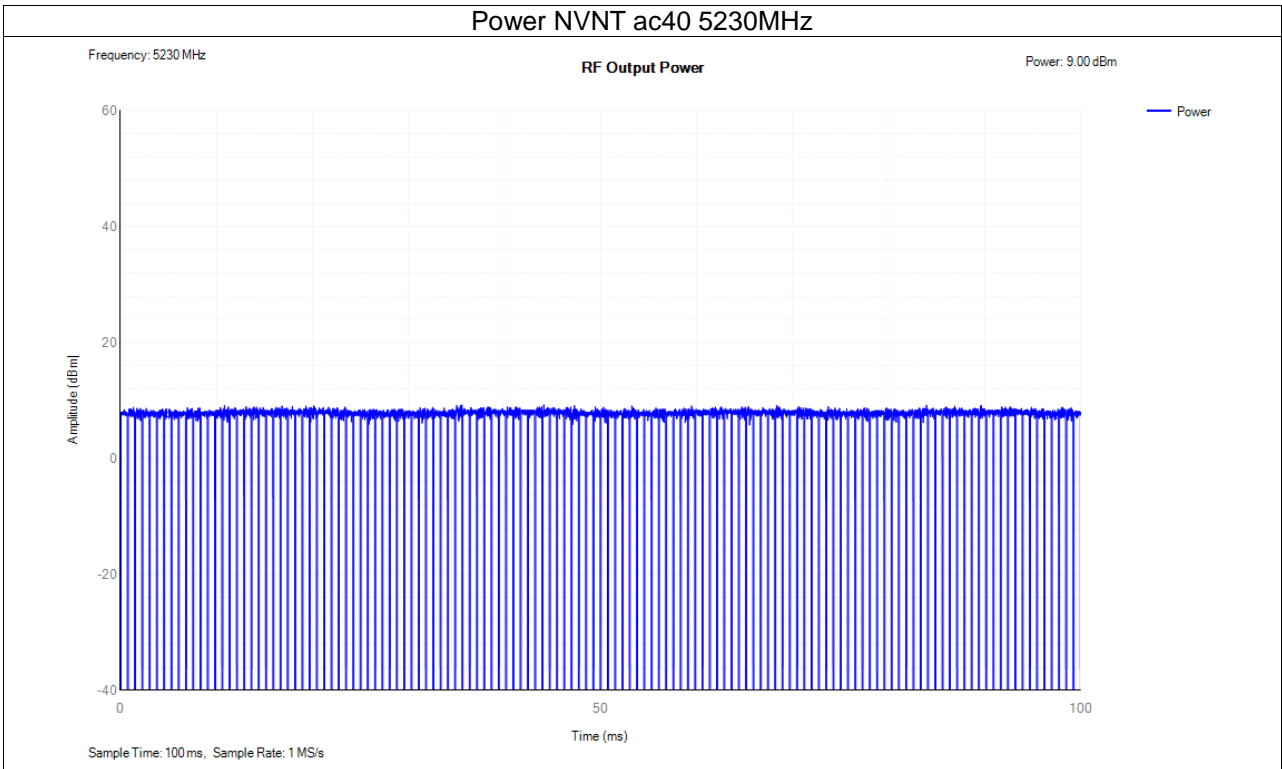

10. Power Spectral Density

10.1 Block Diagram Of Test Setup

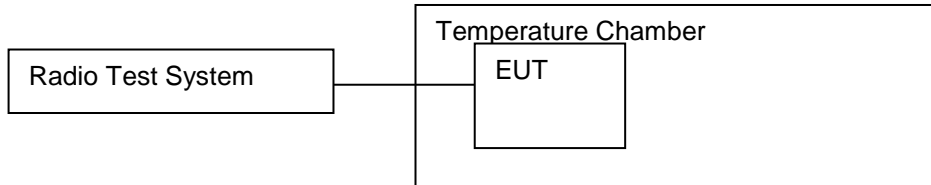

10.2 Limit

Frequency range (MHz)	Mean e.i.r.p. limit for P_H (dBm)		Mean e.i.r.p. density limit (dBm/MHz)	
	with TPC	without TPC	with TPC	without TPC
5 150 to 5 350	23	20/23 (see note 1)	10	7/10 (see note 2)
5 470 to 5 725	30 (see note 3)	27 (see note 3)	17 (see note 3)	14 (see note 3)

NOTE 1: The applicable limit is 20 dBm, except for transmissions whose nominal bandwidth falls completely within the band 5 150 MHz to 5 250 MHz, in which case the applicable limit is 23 dBm.

NOTE 2: The applicable limit is 7 dBm/MHz, except for transmissions whose nominal bandwidth falls completely within the band 5 150 MHz to 5 250 MHz, in which case the applicable limit is 10 dBm/MHz.

NOTE 3: Slave devices without a *Radar Interference Detection* function shall comply with the limits for the frequency range 5 250 MHz to 5 350 MHz.

10.3 Test procedure

This option is for equipment that can be configured to operate in a continuous transmit mode or with a constant duty cycle (x).

Step 1:

- Connect the UUT to the spectrum analyser and use the following settings:
 - Centre Frequency: The centre frequency of the channel under test
 - RBW: 1 MHz
 - VBW: 3 MHz
 - Frequency Span: 2 x Nominal Bandwidth (e.g. 40 MHz for a 20 MHz channel)
 - Detector Mode: Peak
 - Trace Mode: Max Hold

Step 2:

- When the trace is complete, find the peak value of the power envelope and record the frequency.

Step 3:

- Make the following changes to the settings of the spectrum analyser:
 - Centre Frequency: Equal to the frequency recorded in step 2
 - Frequency Span: 3 MHz
 - RBW: 1 MHz
 - VBW: 3 MHz
 - Sweep Time: 1 minute
 - Detector Mode: RMS
 - Trace Mode: Max Hold

Step 4:

- When the trace is complete, the trace shall be captured using the "Hold" or "View" option on the spectrum analyser.
- Find the peak value of the trace and place the analyser marker on this peak. This level is recorded as the highest mean power (Power Density) D in a 1 MHz band.
- Alternatively, where a spectrum analyser is equipped with a function to measure spectral Power Density, this function may be used to display the Power Density D in dBm / MHz.
- In case of conducted measurements on smart antenna systems operating in a mode with multiple transmit chains active simultaneously, the Power Density of each transmit chain shall be measured separately to calculate the total Power Density (value D in dBm / MHz) for the UUT.

Step 5:

- The maximum spectral Power Density e.i.r.p. is calculated from the above measured Power Density D, the observed duty cycle x (see clause 5.4.4.2.1.1.2, step 1), the applicable antenna assembly gain G in dBi and if applicable the beamforming gain Y in dB, according to the formula below. This value shall be recorded in the test report. If more than one antenna assembly is intended for this power setting, the gain of the antenna assembly with the highest gain shall be used:

$$PD = D + G + Y + 10 \times \log (1 / x) \text{ (dBm / MHz) (14)}$$

10.4 Test Result

Condition	Mode	Frequency (MHz)	Max PSD (dBm/MHz)	Limit (dBm/MHz)	Verdict
NVNT	a	5180	0.56	10	Pass
NVNT	a	5200	0.88	10	Pass
NVNT	a	5240	1.46	10	Pass
NVNT	n20	5180	-1.00	10	Pass
NVNT	n20	5200	-0.88	10	Pass
NVNT	n20	5240	0.01	10	Pass
NVNT	n40	5190	-5.42	10	Pass
NVNT	n40	5230	-4.97	10	Pass
NVNT	ac20	5180	-1.00	10	Pass
NVNT	ac20	5200	-1.08	10	Pass
NVNT	ac20	5240	-0.24	10	Pass
NVNT	ac40	5190	-5.43	10	Pass
NVNT	ac40	5230	-4.82	10	Pass
NVNT	ac80	5210	-8.44	10	Pass

Test Graphs
PSD NVNT a 5180MHz

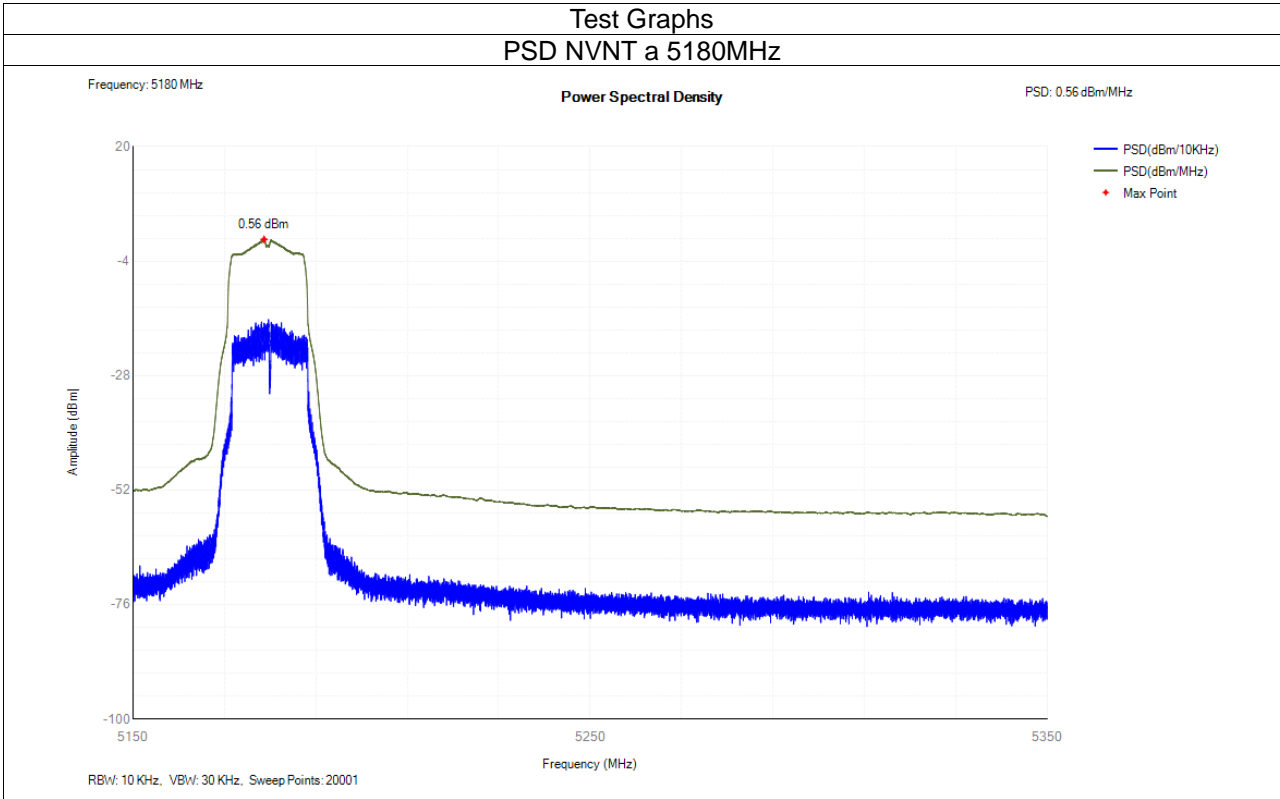

PSD NVNT a 5200MHz

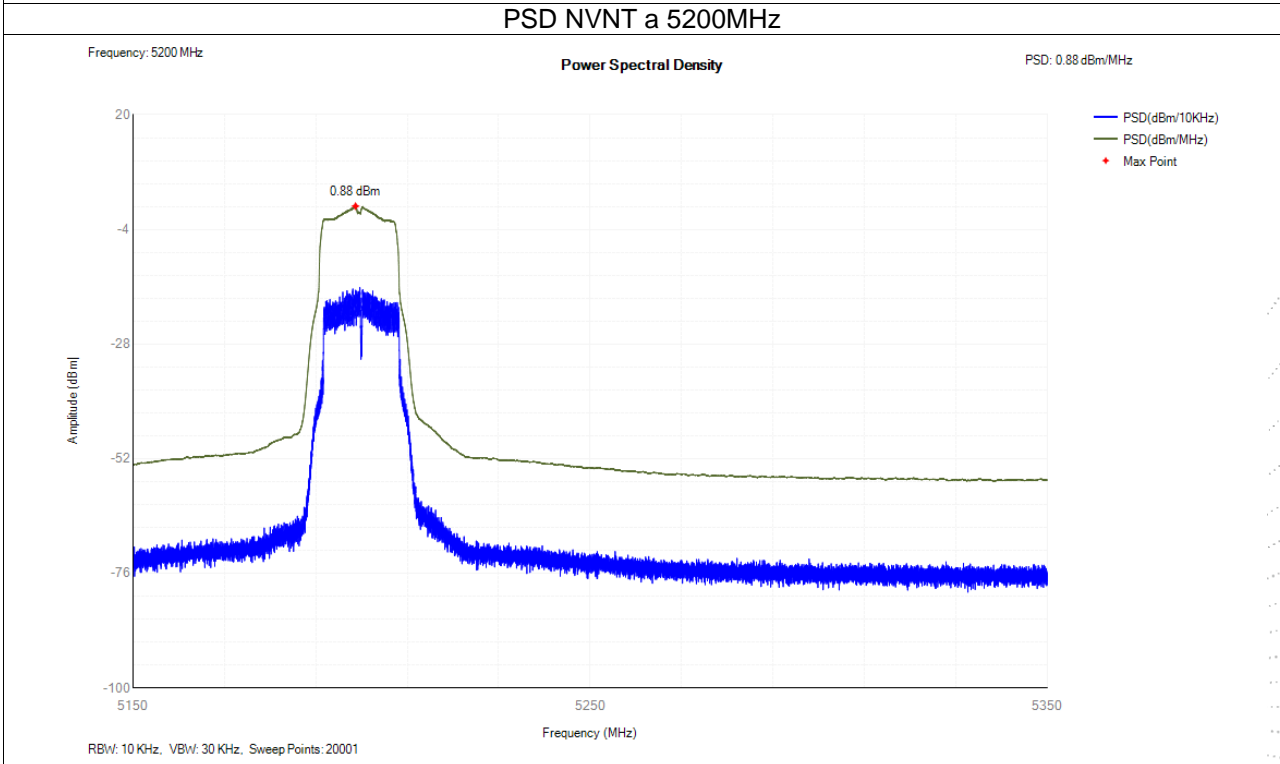

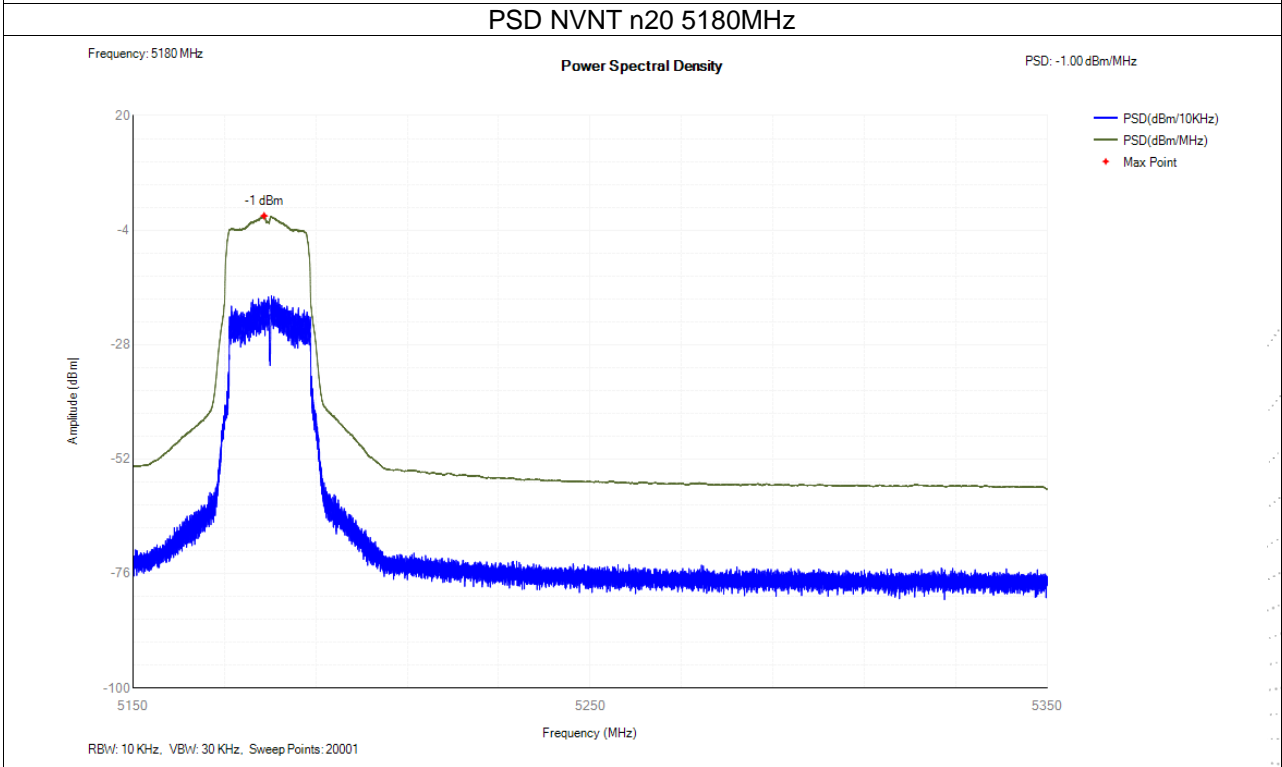
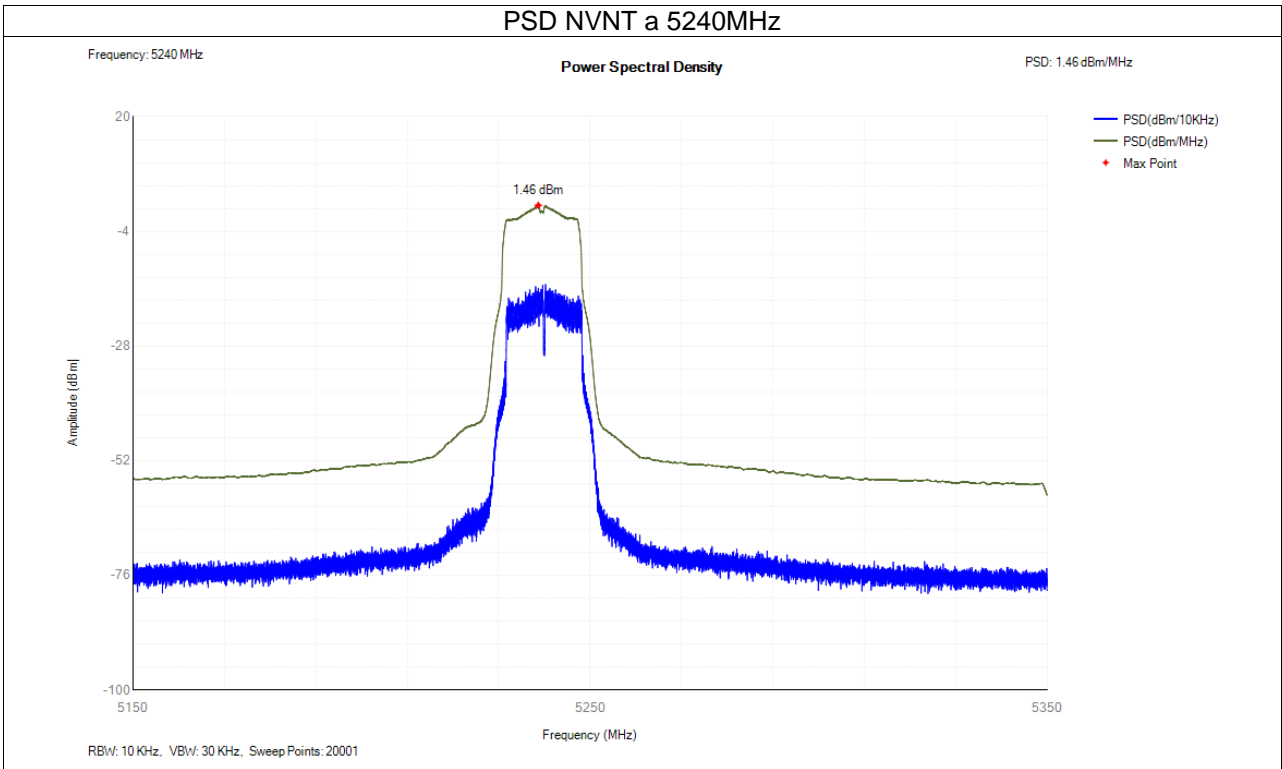

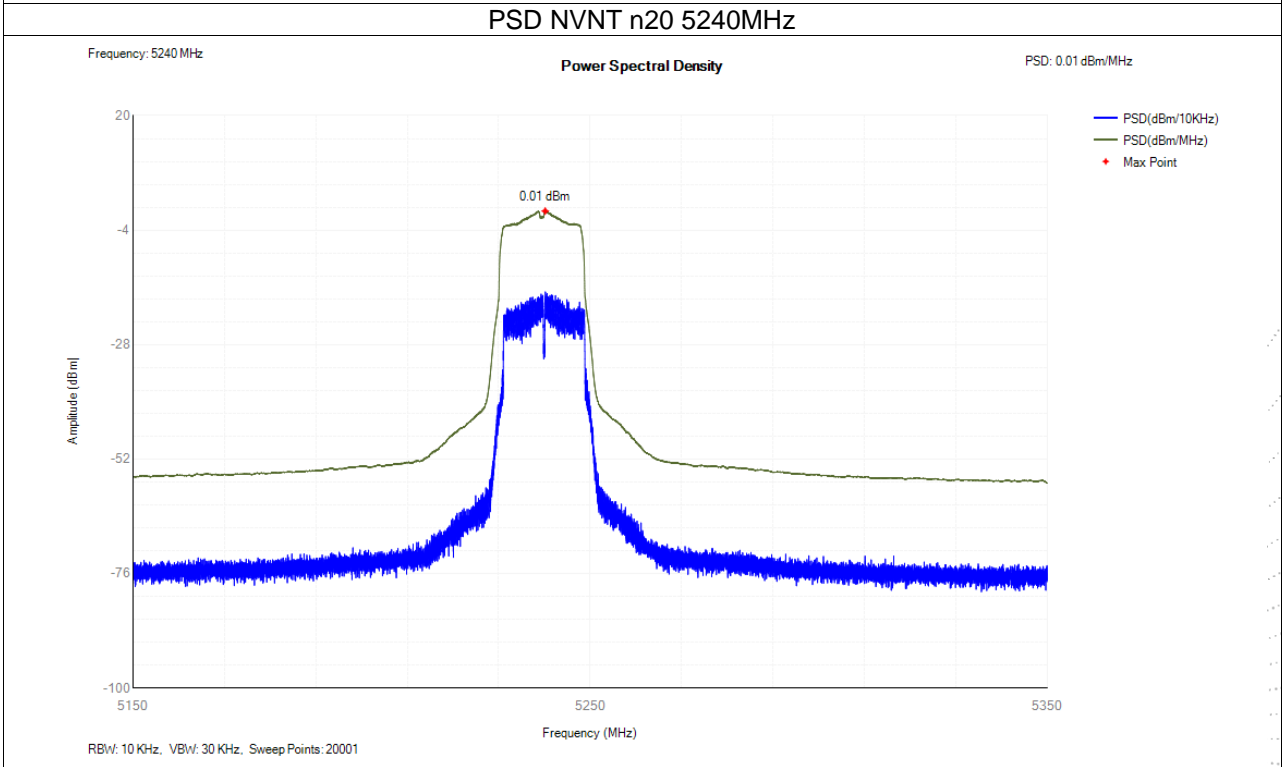
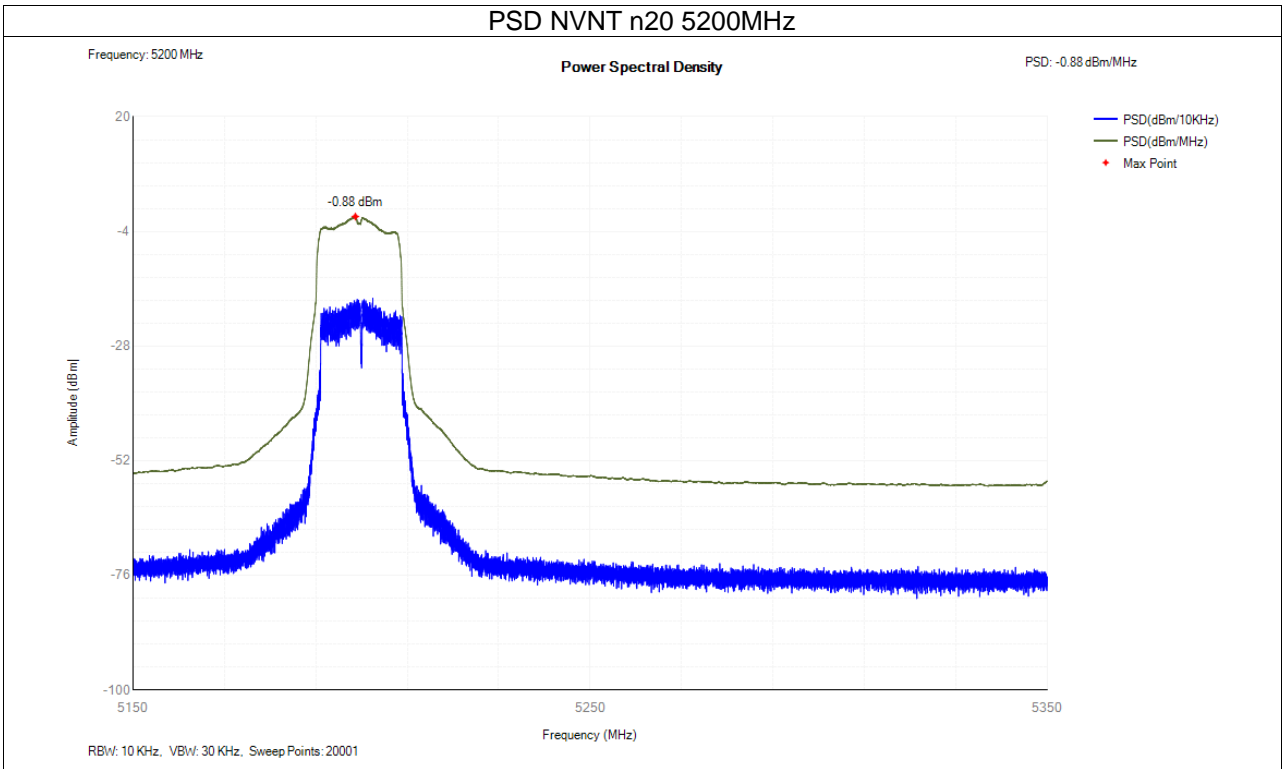

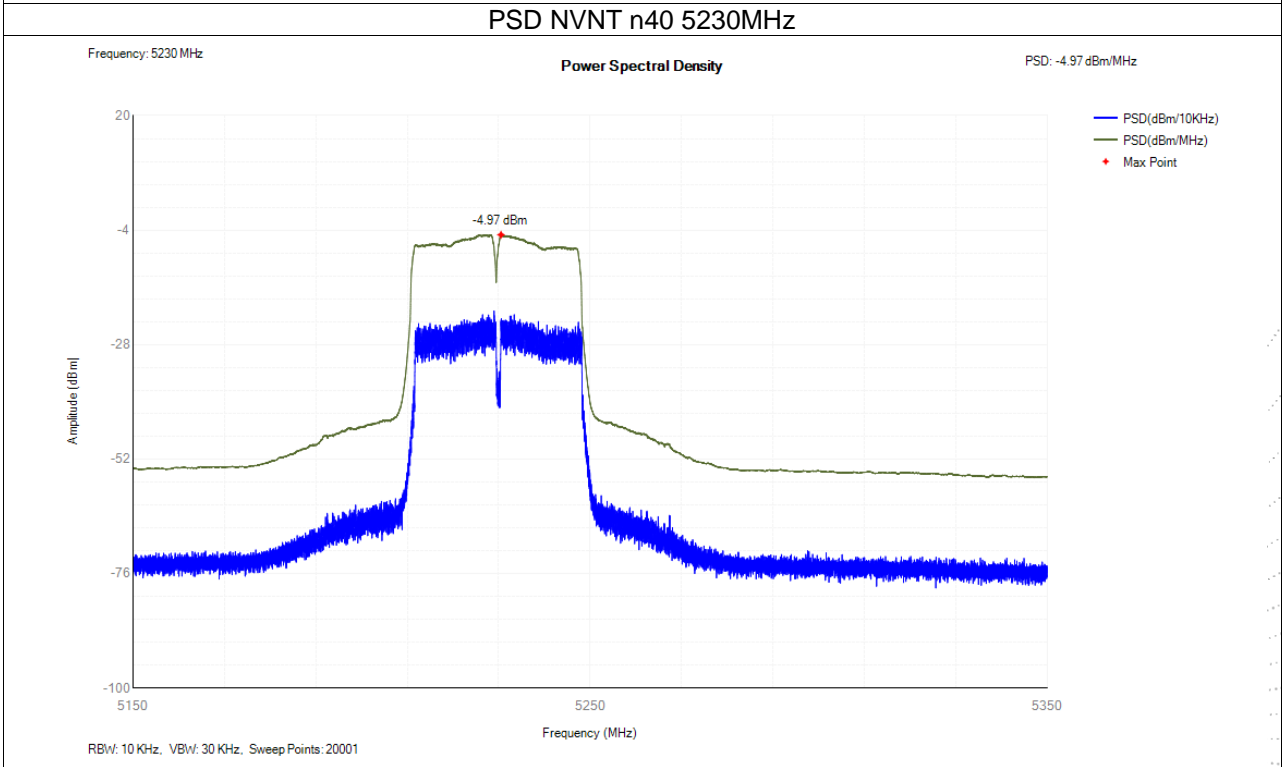
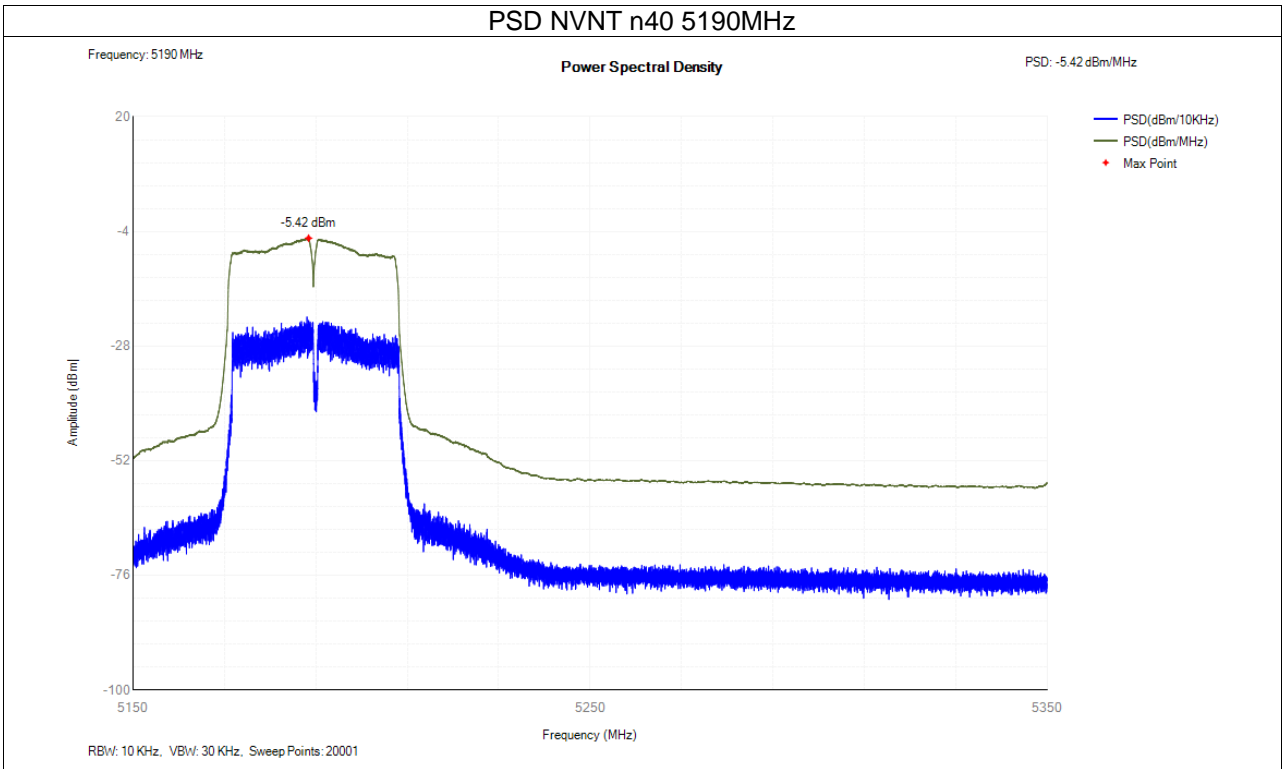

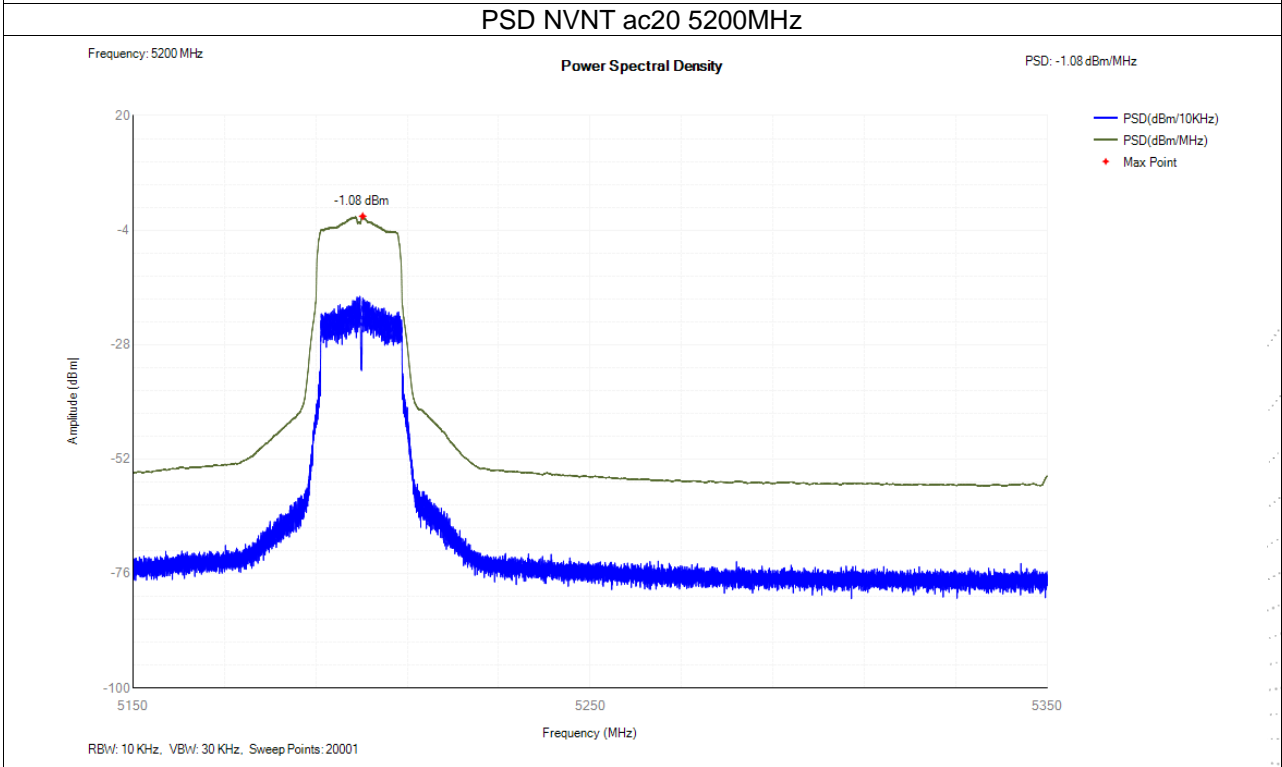
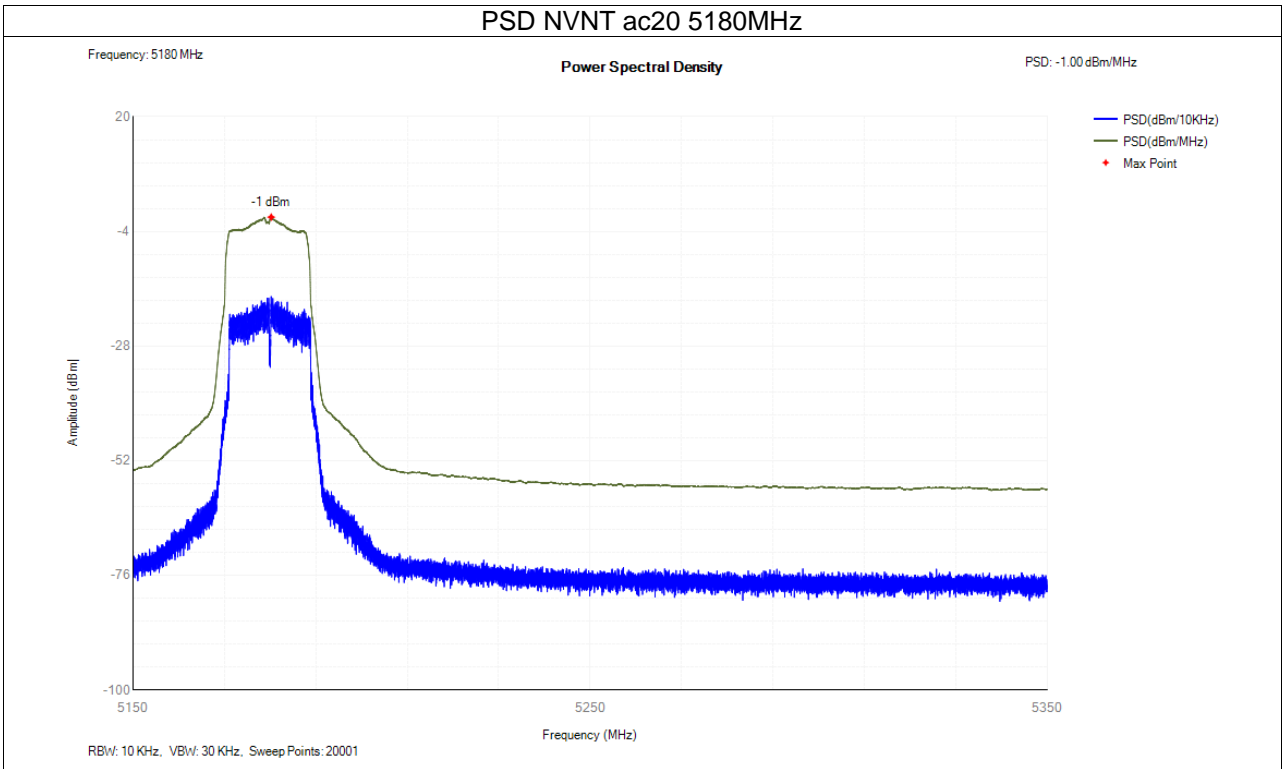

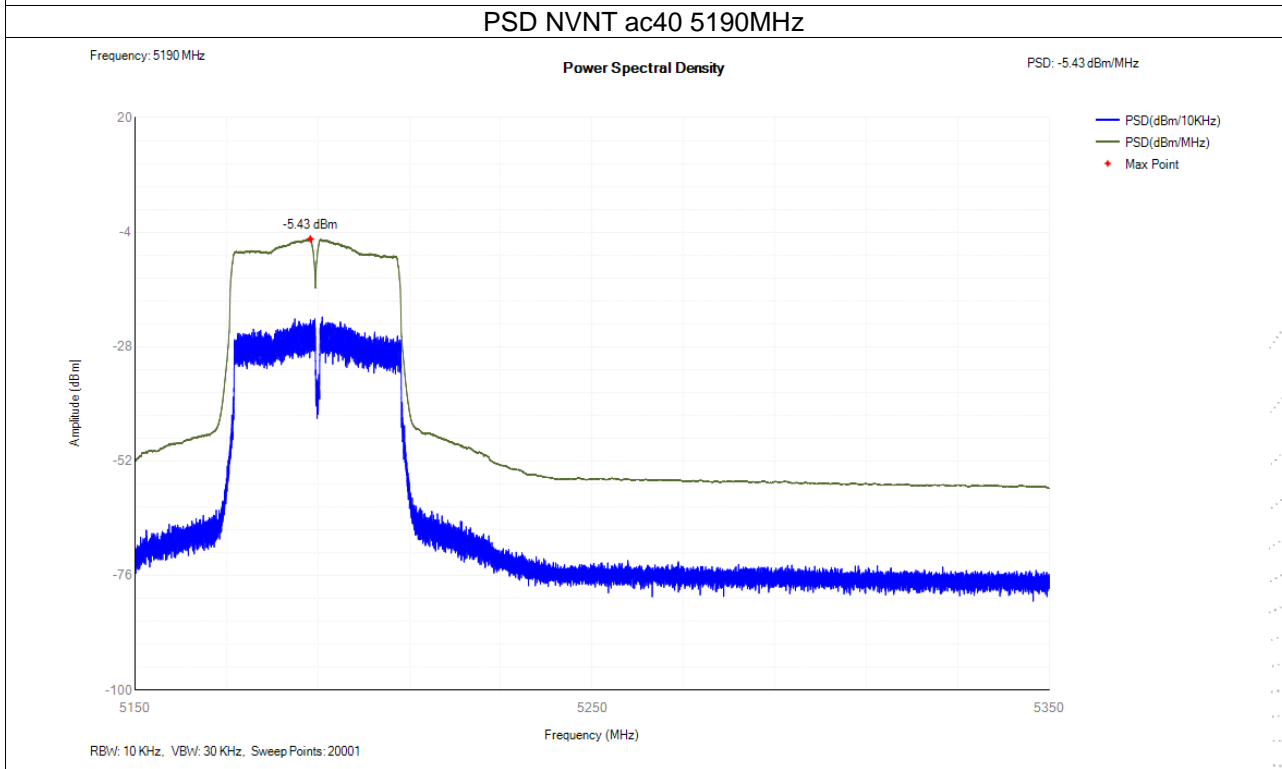
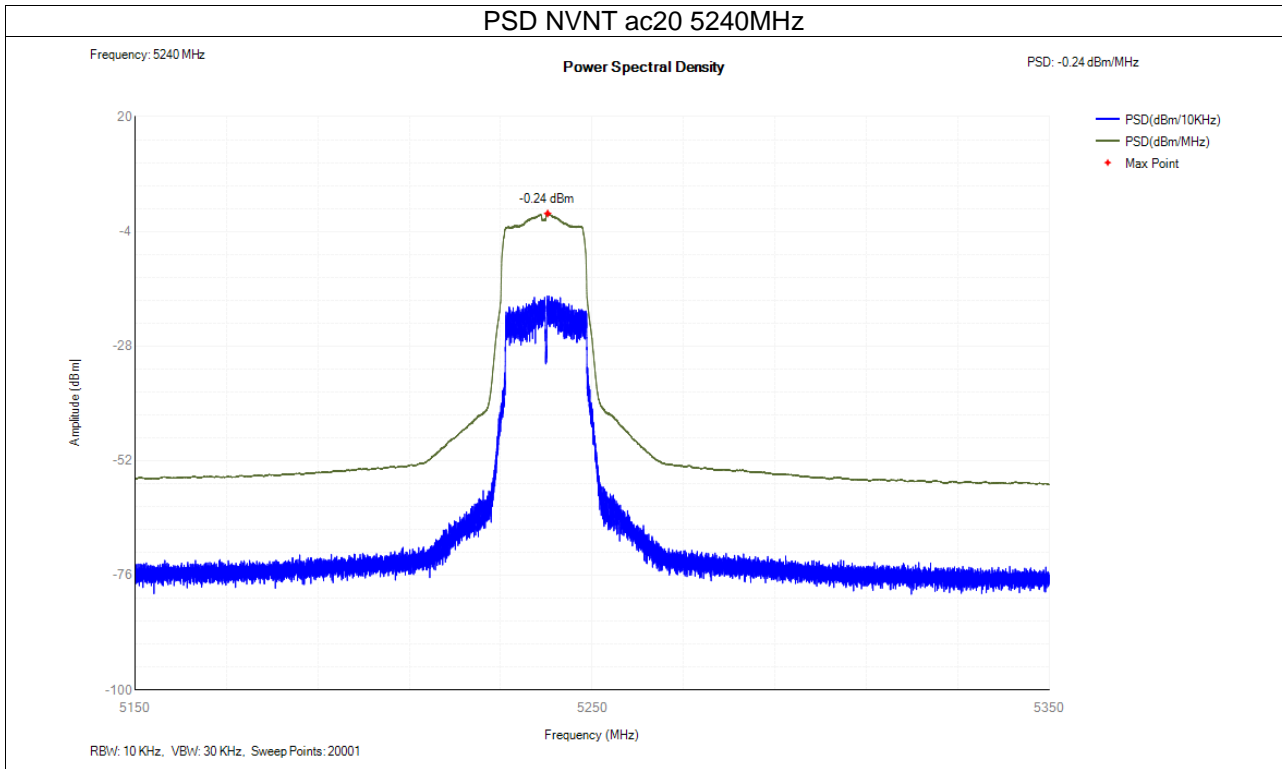

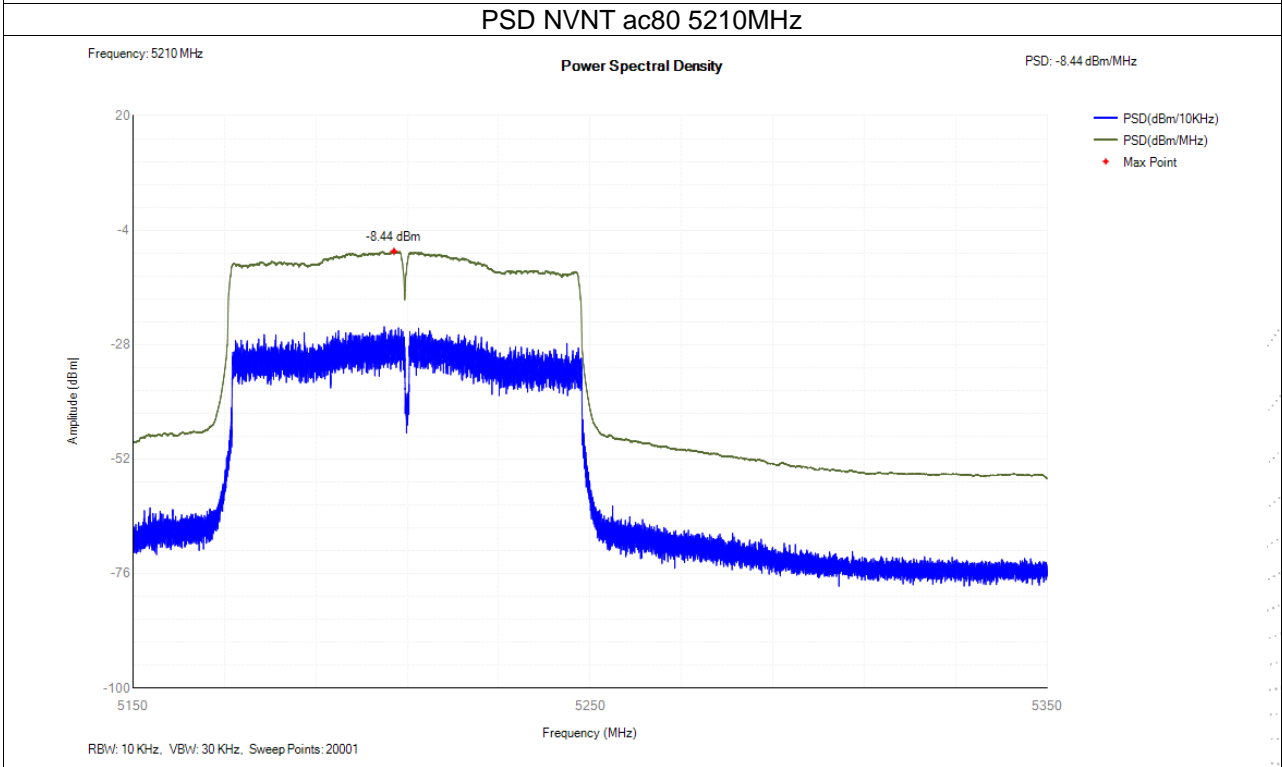
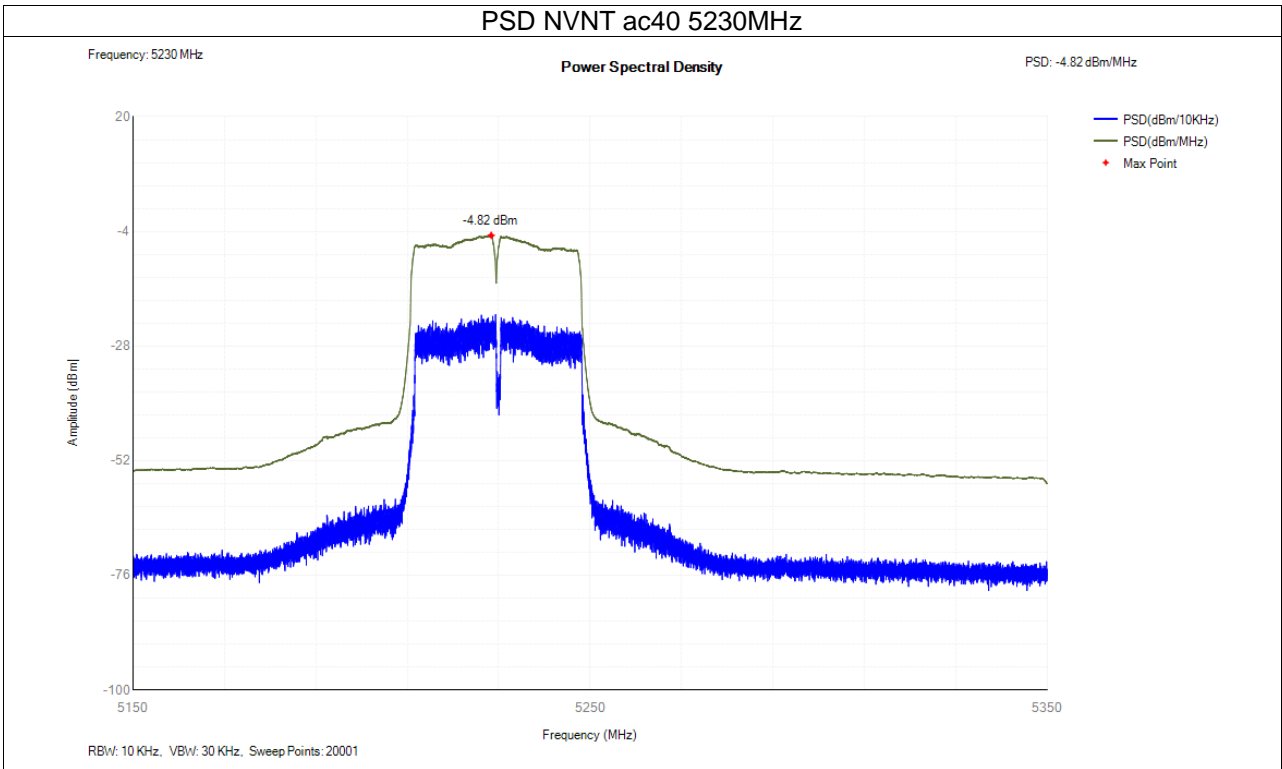

11. Transmitter Unwanted Emissions In The Spurious Domain

11.1 Block Diagram Of Test Setup

(A) Radiated Emission Test Set-Up Frequency Below 1GHz.

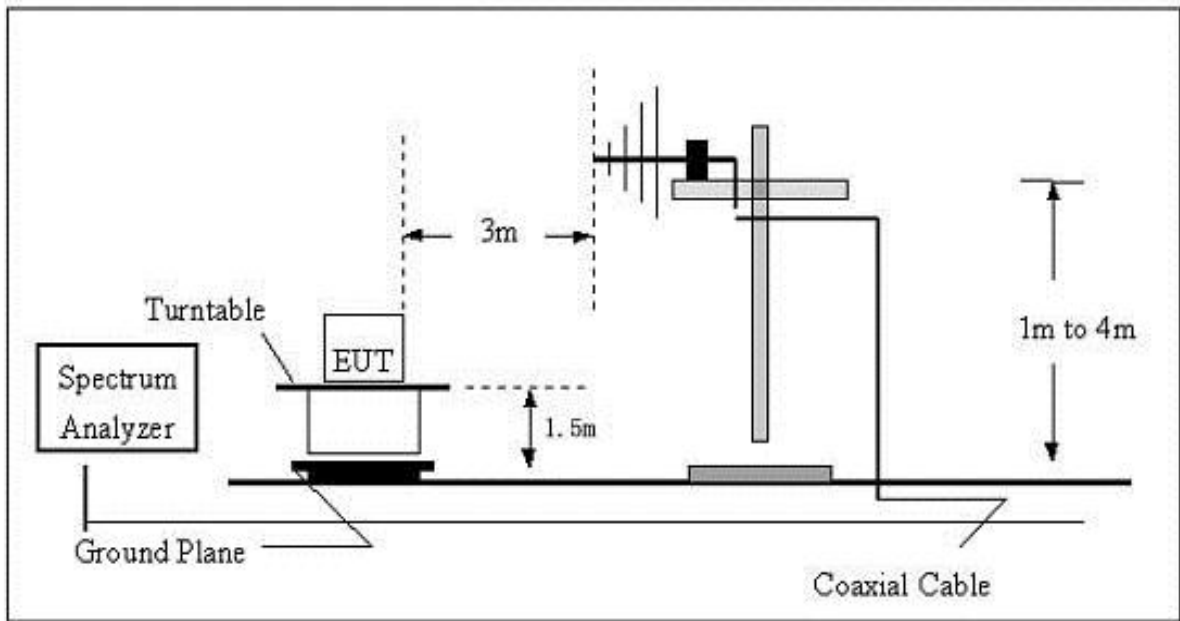

(B) Radiated Emission Test Set-Up Frequency Above 1GHz.

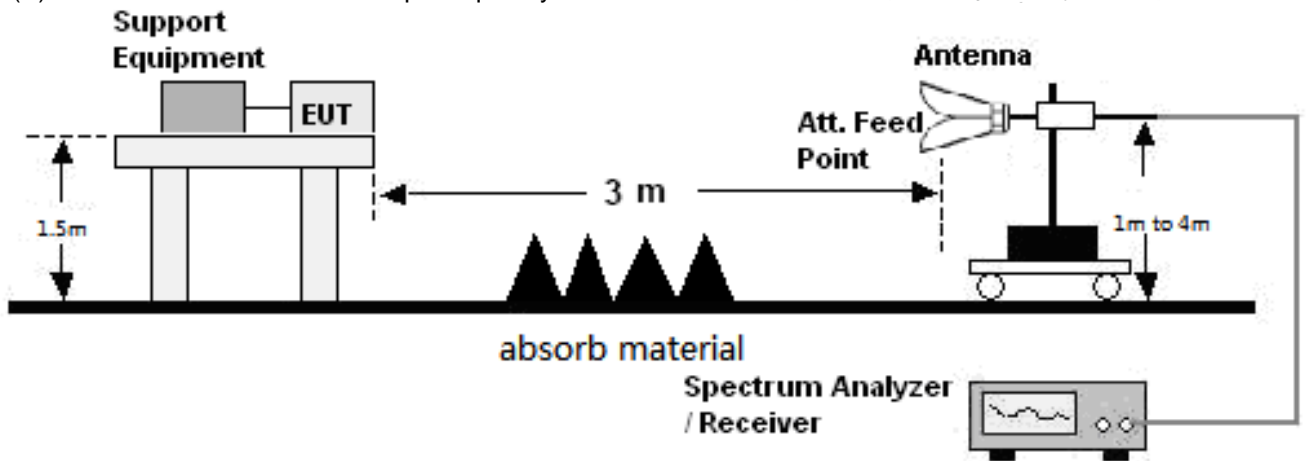

11.2 Limits

Frequency range	Maximum power, e.r.p. (≤ 1 GHz) e.i.r.p. (> 1 GHz)	Bandwidth
30 MHz to 47 MHz	-36 dBm	100 kHz/300KHz
47 MHz to 74 MHz	-54 dBm	100 kHz/300KHz
74 MHz to 87,5 MHz	-36 dBm	100 kHz/300KHz
87,5 MHz to 118 MHz	-54 dBm	100 kHz/300KHz
118 MHz to 174 MHz	-36 dBm	100 kHz/300KHz
174 MHz to 230 MHz	-54 dBm	100 kHz/300KHz
230 MHz to 470 MHz	-36 dBm	100 kHz/300KHz
470 MHz to 862 MHz	-54 dBm	100 kHz/300KHz
862 MHz to 1 GHz	-36 dBm	100 kHz/300KHz
1 GHz to 5.15 GHz	-30 dBm	1 MHz/3MHz
5.35 GHz to 5.47 GHz	-30 dBm	1 MHz/3MHz
5.725 GHz to 26 GHz	-30 dBm	1 MHz/3MHz

11.3 Test Procedure

30MHz ~ 1GHz:

- The Product was placed on the nonconductive turntable 1.5m above the ground in a full anechoic chamber.
- Set the spectrum analyzer/receiver in Peak detector, Max Hold mode, and 120 kHz RBW. Record the maximum field strength of all the pre-scan process in the full band when the antenna is varied between 1~4 m in both horizontal and vertical, and the turntable is rotated from 0 to 360 degrees.
- For each frequency whose maximum record was higher or close to limit, measure its QP value: vary the antenna's height and rotate the turntable from 0 to 360 degrees to find the height and degree where Product radiated the maximum emission, then set the test frequency analyzer/receiver to QP Detector and specified bandwidth with Maximum Hold Mode, and record the maximum value.

Above 1GHz:

- The Product was placed on the non-conductive turntable 1.5 m above the ground in a full anechoic chamber..
- Set the spectrum analyzer/receiver in Peak detector, Max Hold mode, and 1MHz RBW. Record the maximum field strength of all the pre-scan process in the full band when the antenna is varied in both horizontal and vertical, and the turntable is rotated from 0 to 360 degrees.
- For each frequency whose maximum record was higher or close to limit, measure its AV value: rotate the turntable from 0 to 360 degrees to find the degree where Product radiated the maximum emission, then set the test frequency analyzer/receiver to AV value and specified bandwidth with Maximum Hold Mode, and record the maximum value.

11.4 Test Results

All modes have been tested and reports show data in the worst mode

Test Mode: Transmitting 802.11n20 (worst case)

Frequency	Receiver Reading	Turn table Angle	RX Antenna		Correct	Absolute Level	Result	
			Height	Polar	Factor		Limit	Margin
(MHz)	(dBm)	Degree	(m)	(H/V)	(dBm)	(dBm)	(dBm)	(dB)
802.11n20 Low channel								
544.75	-55.39	117	1.3	H	-7.81	-63.20	-54	-9.20
544.75	-52.08	14	1.3	V	-7.81	-59.89	-54	-5.89
10360.00	-43.15	58	1.6	H	-0.43	-43.58	-30	-13.58
10360.00	-40.98	210	1.9	V	-0.43	-41.41	-30	-11.41
15540.00	-57.88	70	1.2	H	8.31	-49.57	-30	-19.57
15540.00	-59.79	265	1.0	V	8.31	-51.48	-30	-21.48
802.11n20 Mid channel								
544.75	-55.83	282	1.3	H	-7.81	-63.64	-54	-9.64
544.75	-52.36	194	1.4	V	-7.81	-60.18	-54	-6.18
10400.00	-43.04	202	1.3	H	-0.38	-43.42	-30	-13.42
10400.00	-41.64	344	1.3	V	-0.38	-42.02	-30	-12.02
15600.00	-57.09	273	1.8	H	8.83	-48.26	-30	-18.26
15600.00	-59.90	91	2.0	V	8.83	-51.07	-30	-21.07
802.11n20 High channel								
544.75	-56.24	319	2.0	H	-7.81	-64.05	-54	-10.05
544.75	-51.32	181	1.6	V	-7.81	-59.13	-54	-5.13
10480.00	-42.24	190	1.2	H	-0.32	-42.56	-30	-12.56
10480.00	-41.66	157	1.8	V	-0.32	-41.98	-30	-11.98
15720.00	-57.40	155	1.8	H	9.35	-48.05	-30	-18.05
15720.00	-60.76	251	1.1	V	9.35	-51.41	-30	-21.41

12. Transmitter Unwanted Emissions In The Out-Of-Band Domain

12.1 Block Diagram Of Test Setup

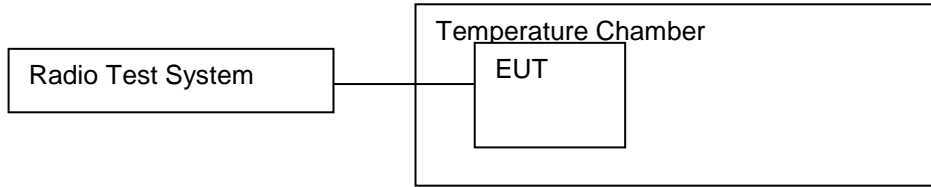

12.2 Limit

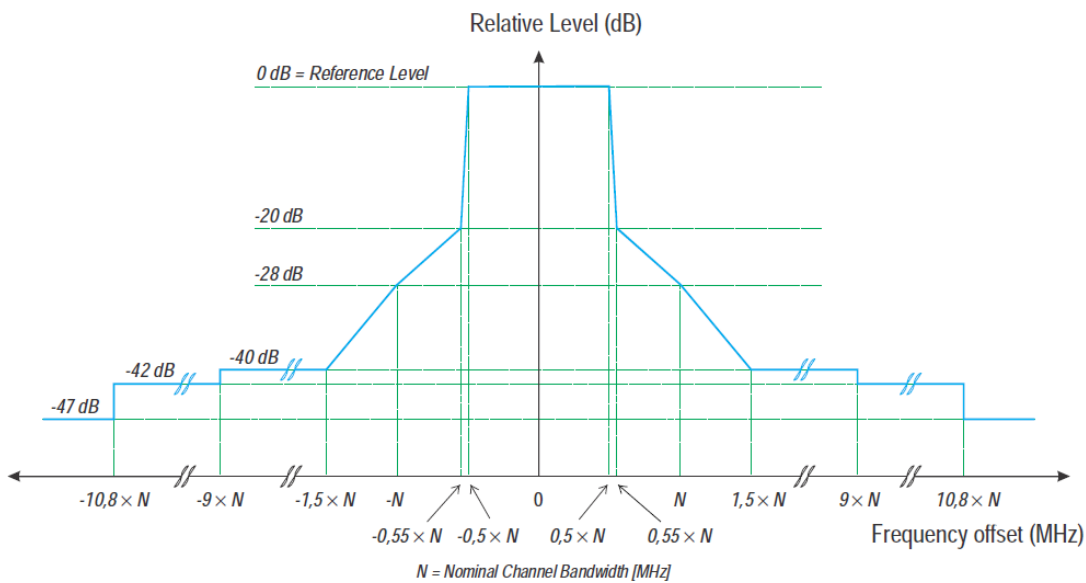

12.3 Test procedure

The UUT shall be configured for continuous transmit mode (duty cycle equal to 100 %). If this is not possible, then option 2 shall be used.

Step 1: Determination of the reference average power level.

- Spectrum analyser settings:
 - Resolution bandwidth: 1 MHz
 - Video bandwidth: 30 kHz
 - Detector mode: Peak
 - Trace mode: Video Average
 - Sweep Time: Coupled
 - Centre Frequency: Centre frequency of the channel being tested
 - Span: $2 \times \text{Nominal Channel Bandwidth}$
- Use the marker to find the highest average power level of the power envelope of the UUT. This level shall be used as the reference level for the relative measurements.

Step 2: Determination of the relative average power levels.

- Adjust the frequency range of the spectrum analyser to allow the measurement to be performed within the sub-bands 5 150 MHz to 5 350 MHz and 5 470 MHz to 5 725 MHz. No other parameter of the spectrum analyser should be changed.
- Compare the relative power envelope of the UUT with the limits defined in clause 4.2.4.2.2.

12.4 Test Result

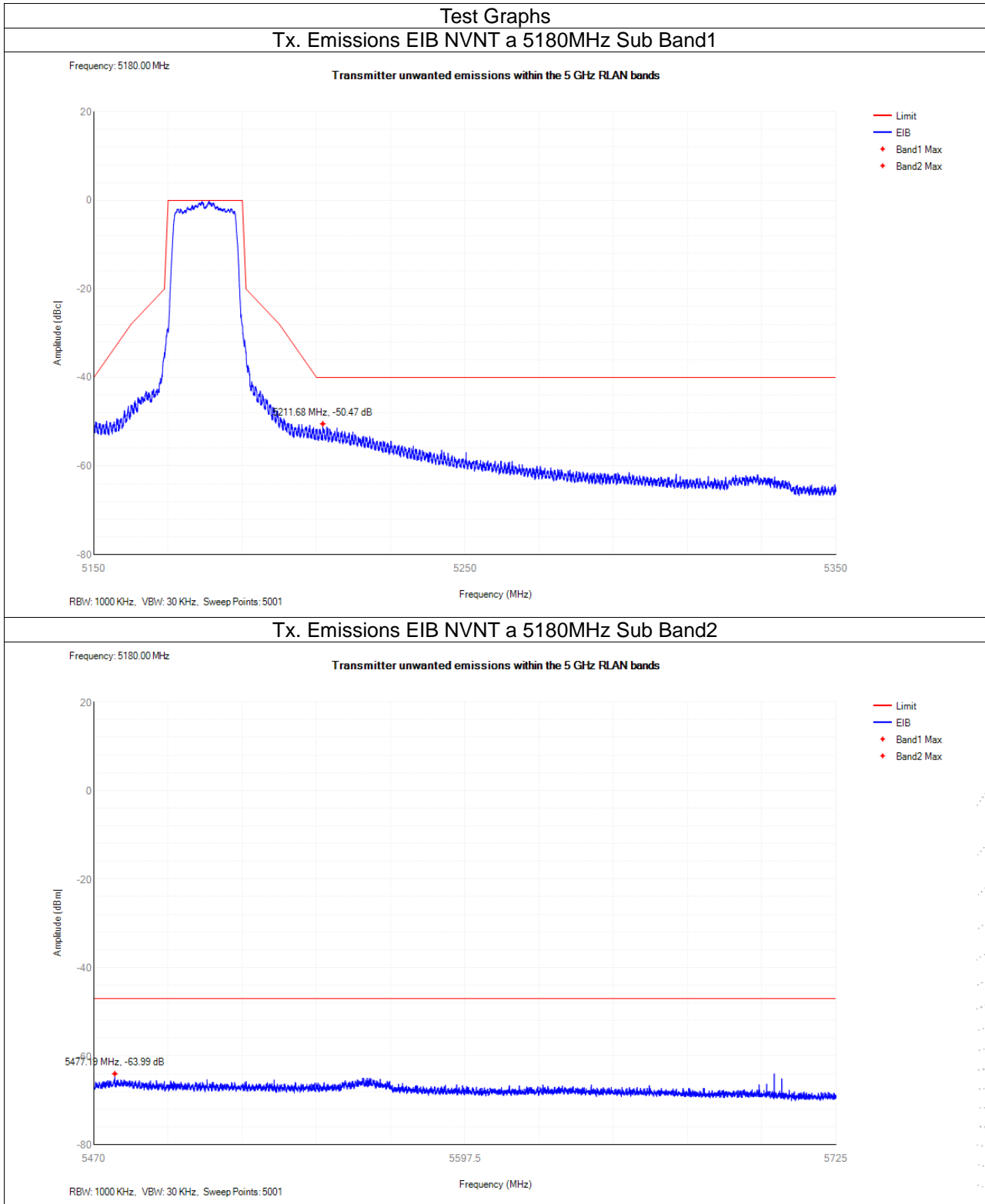

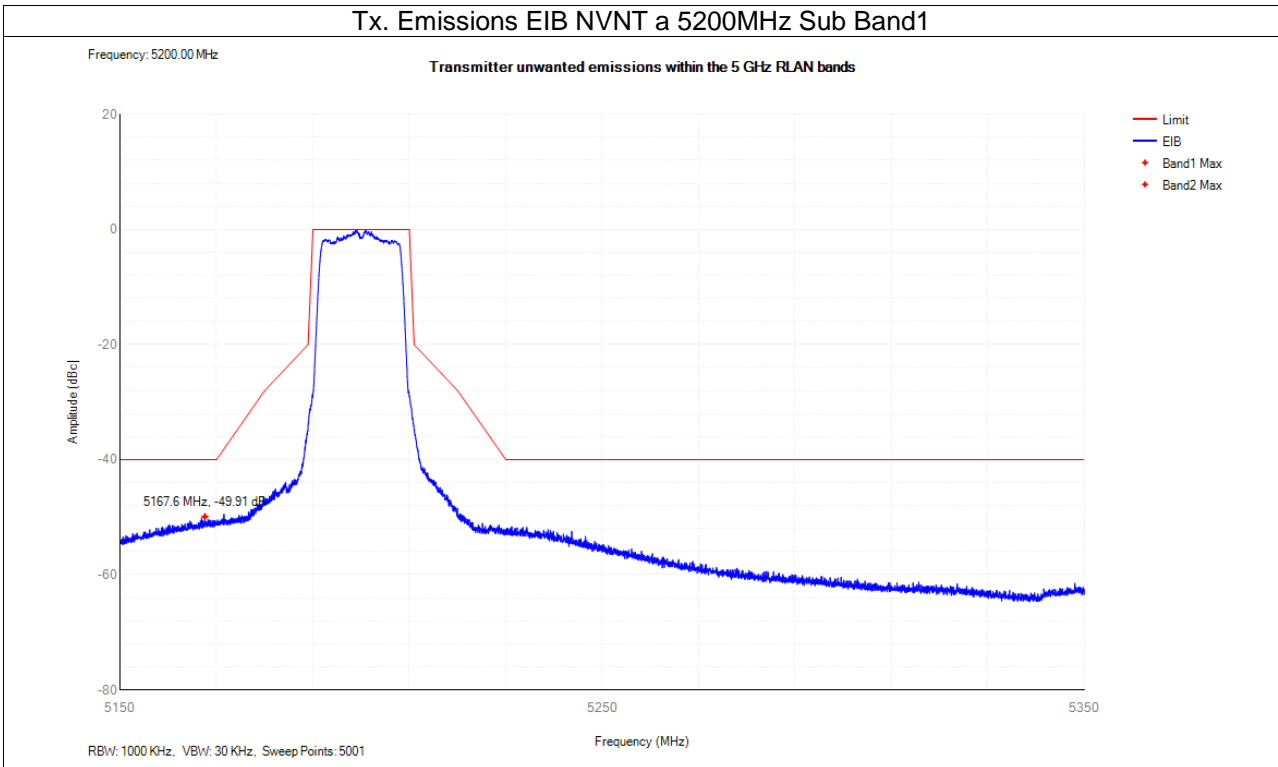
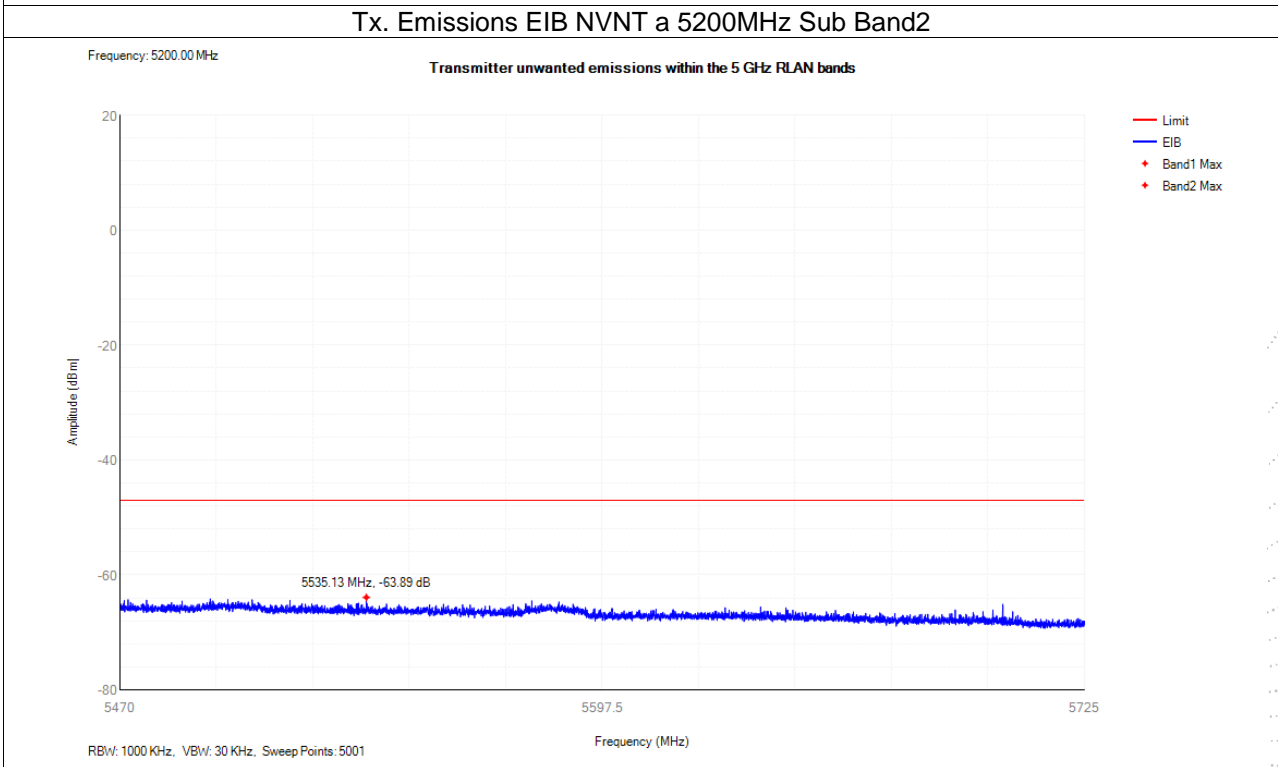
Tx. Emissions EIB NVNT a 5200MHz Sub Band1

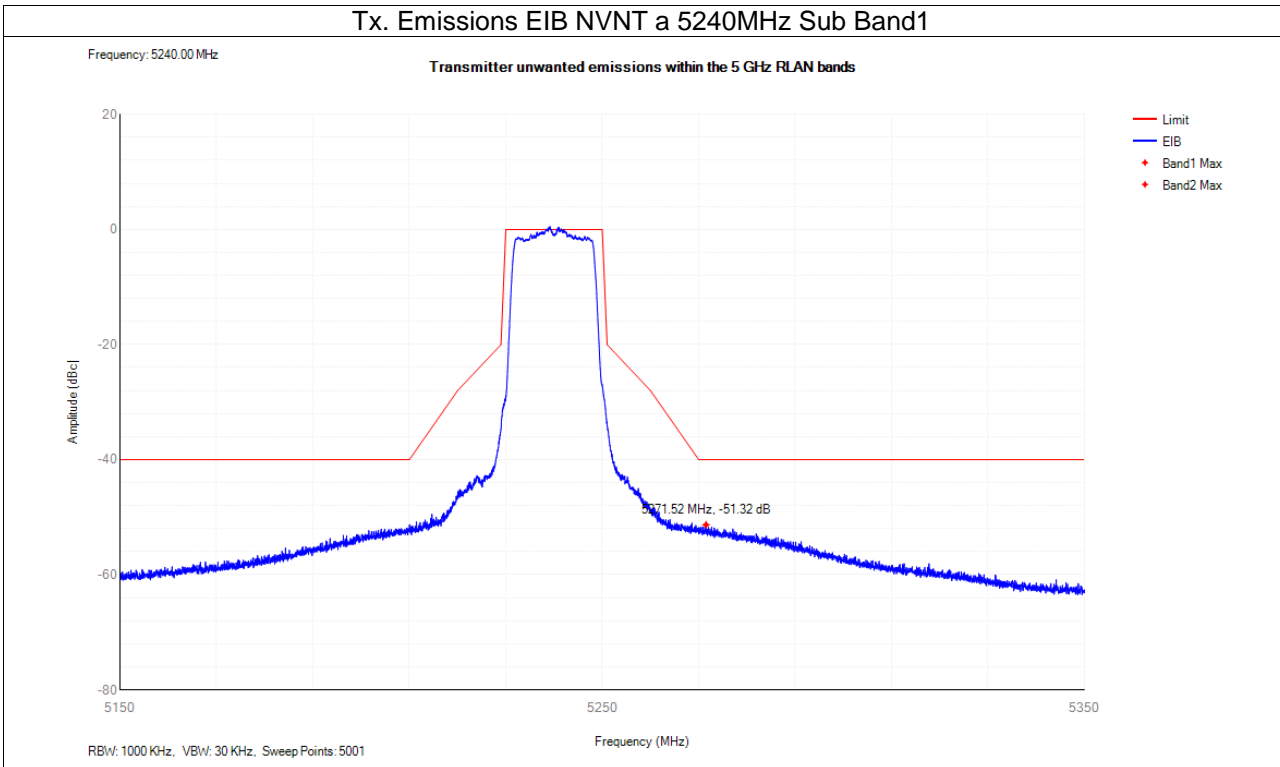
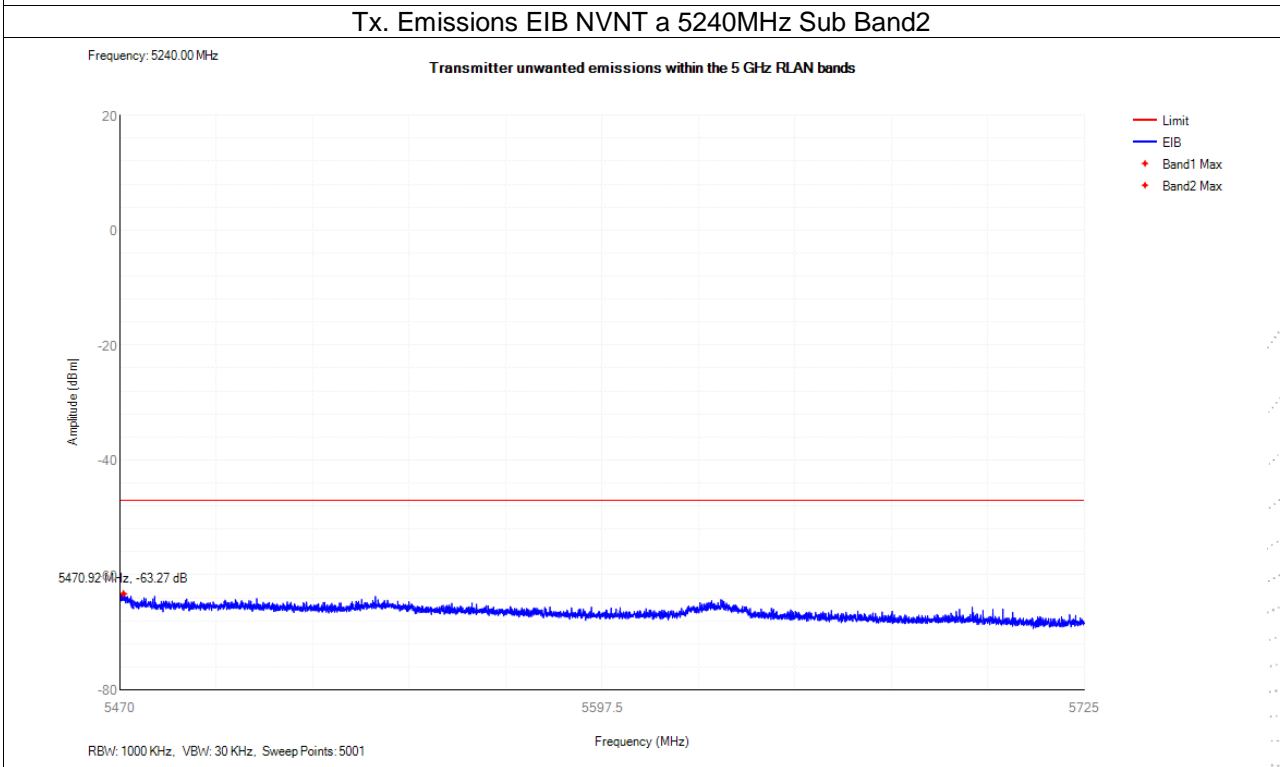
Tx. Emissions EIB NVNT a 5200MHz Sub Band2

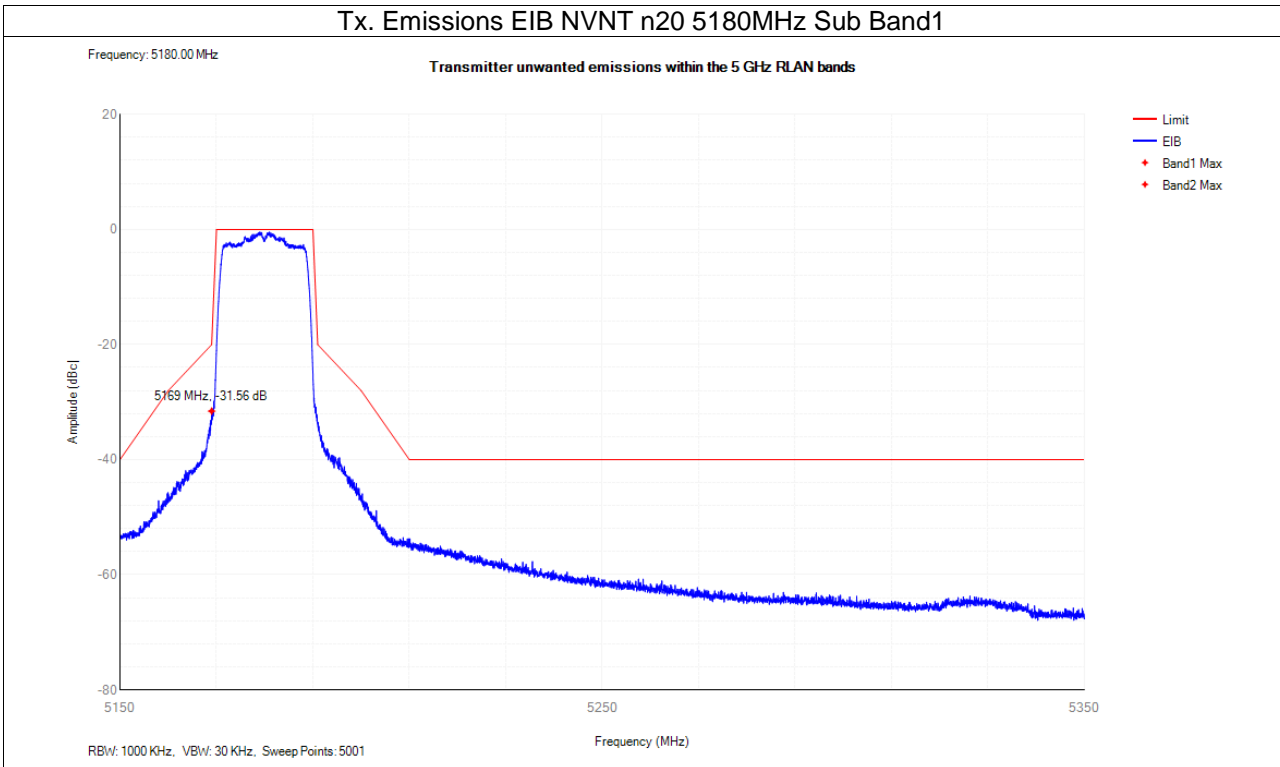
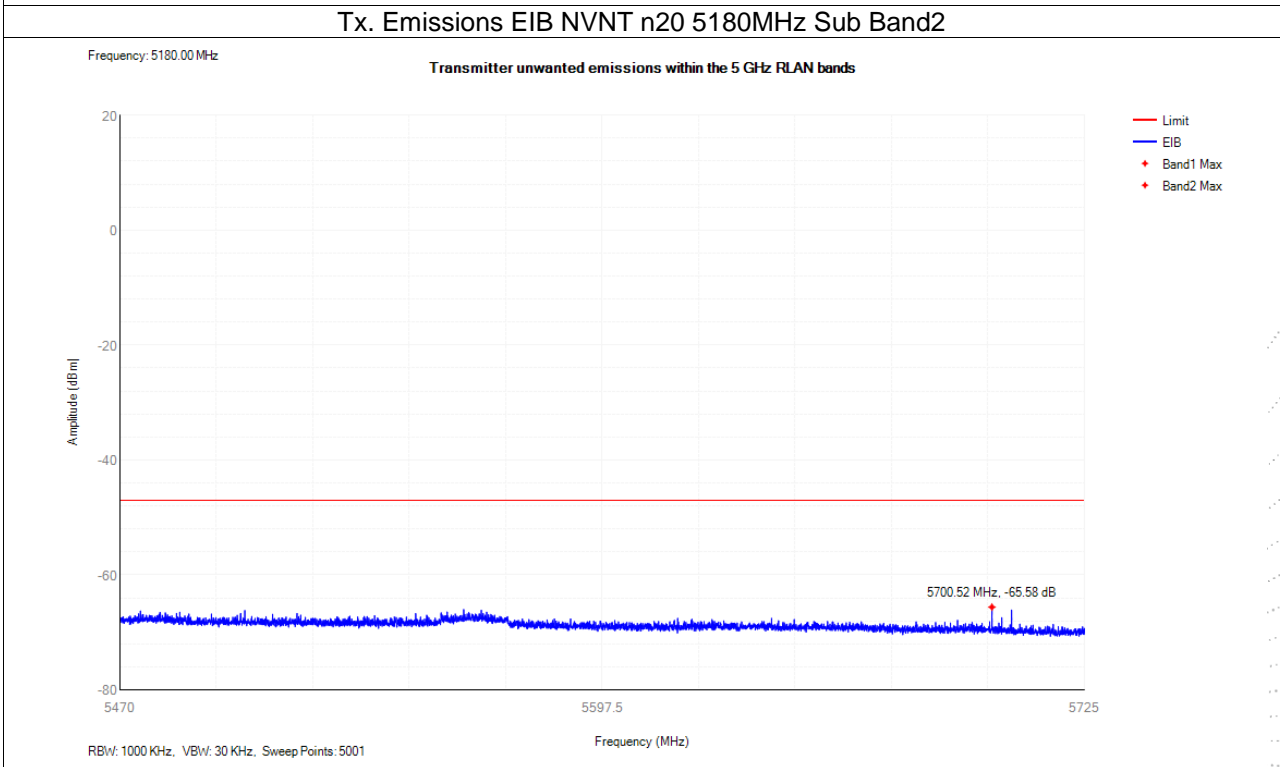
Tx. Emissions EIB NVNT a 5240MHz Sub Band1

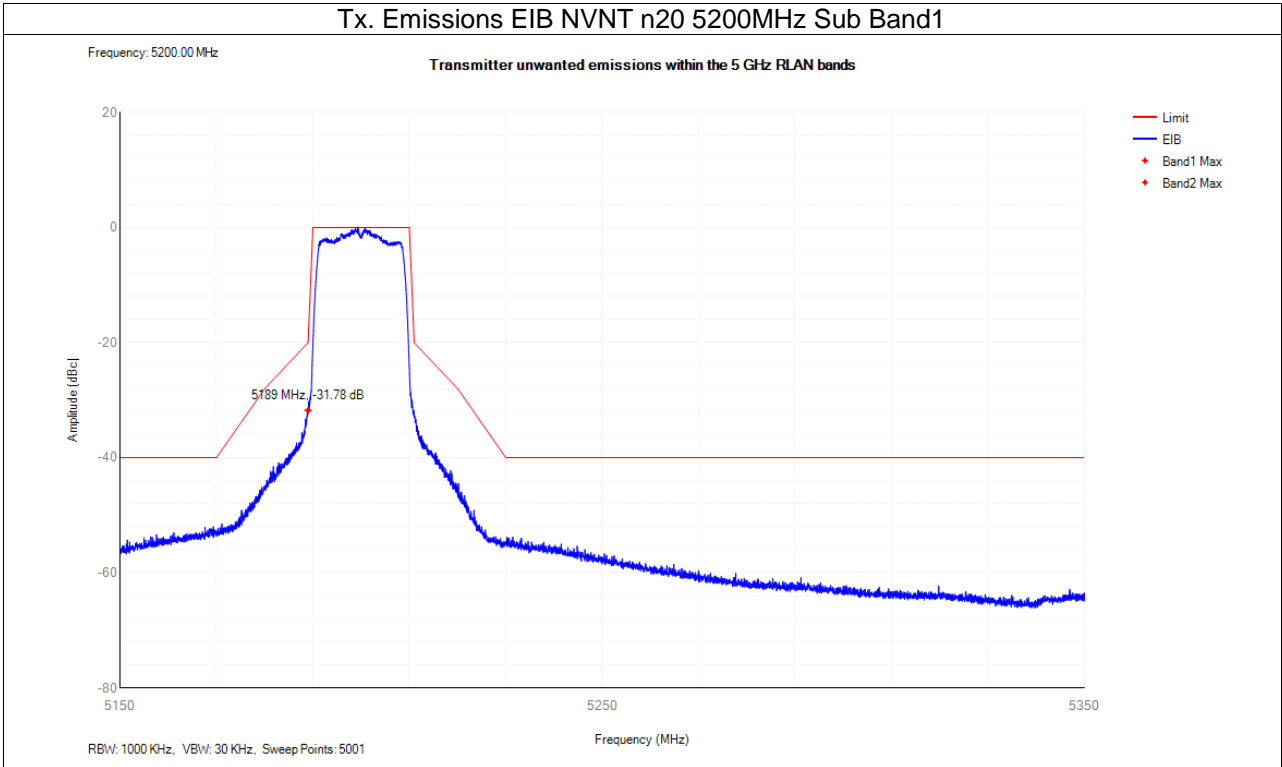
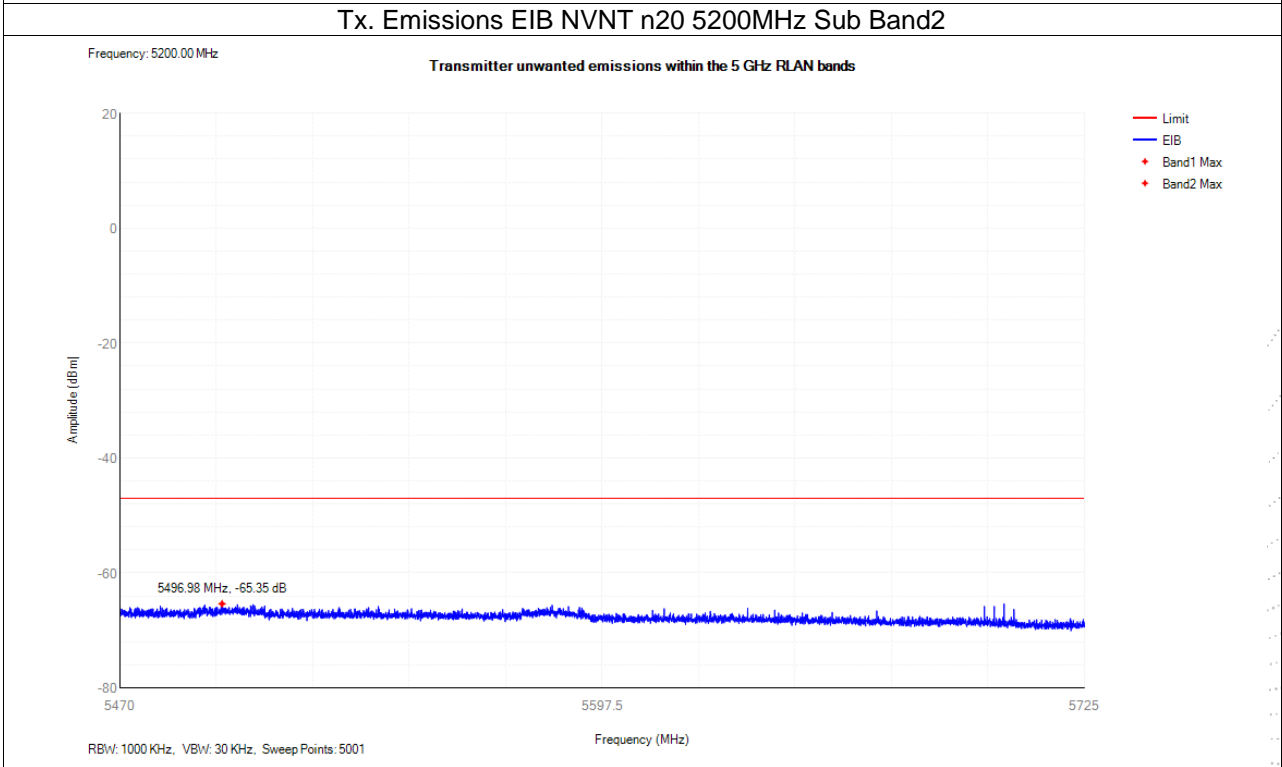
Tx. Emissions EIB NVNT a 5240MHz Sub Band2

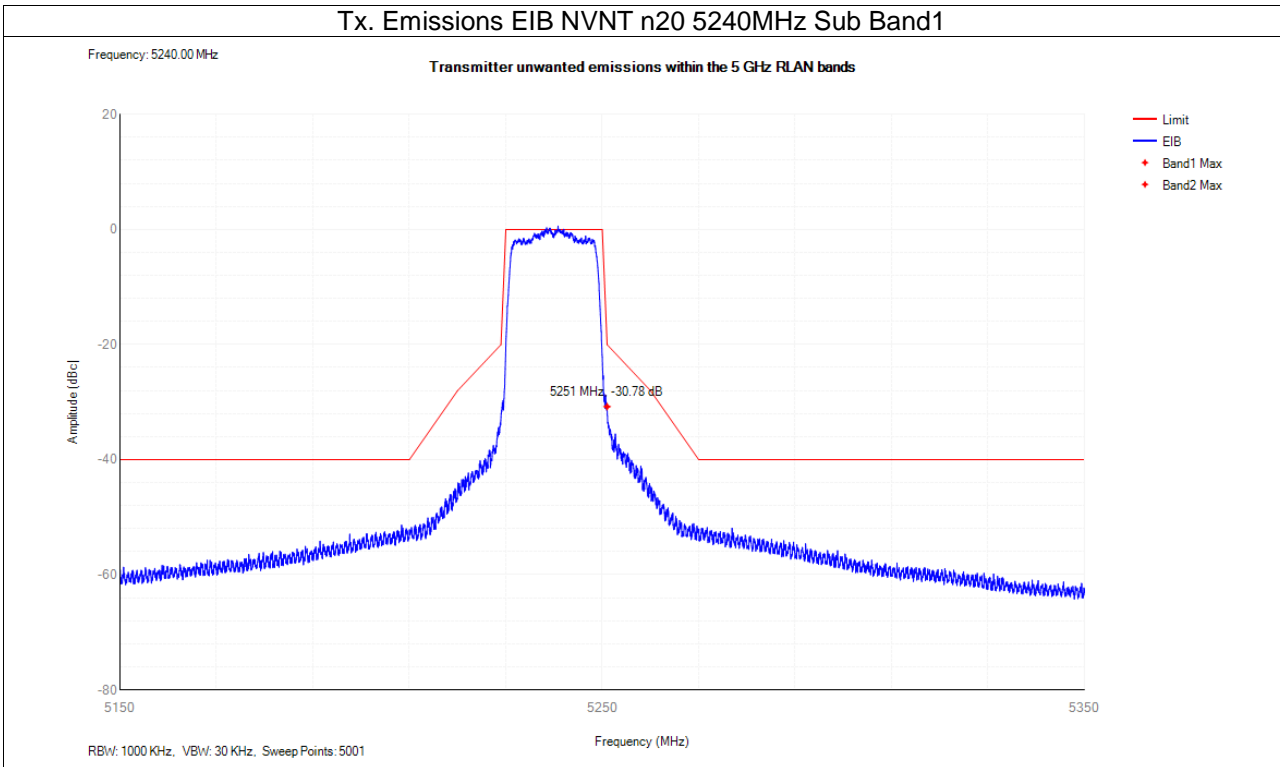
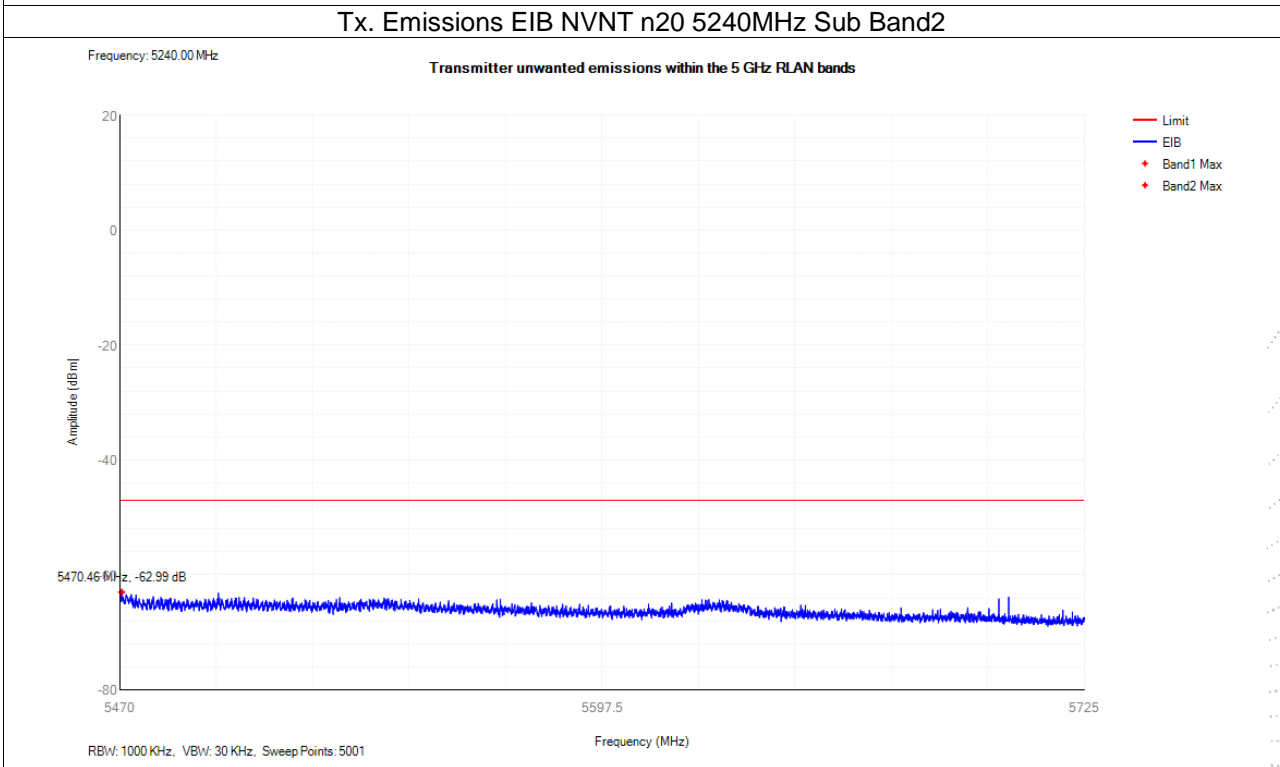
Tx. Emissions EIB NVNT n20 5180MHz Sub Band1

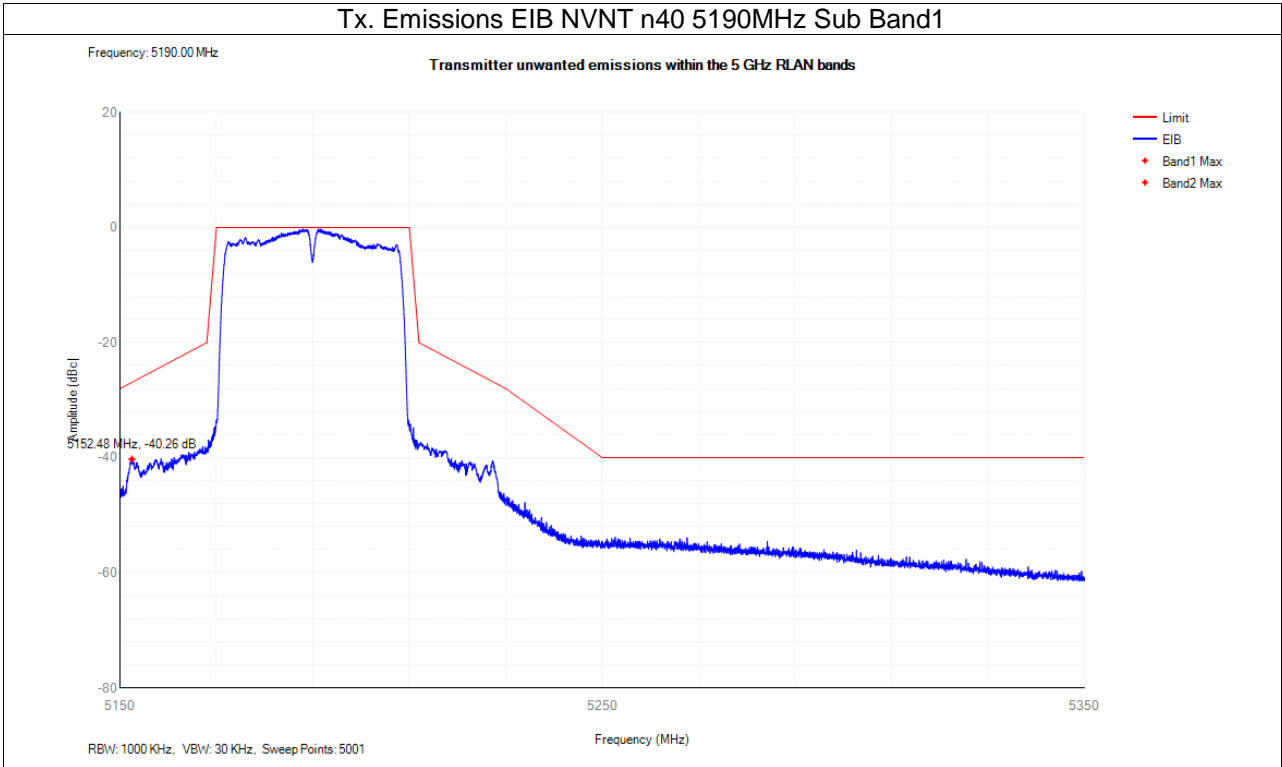
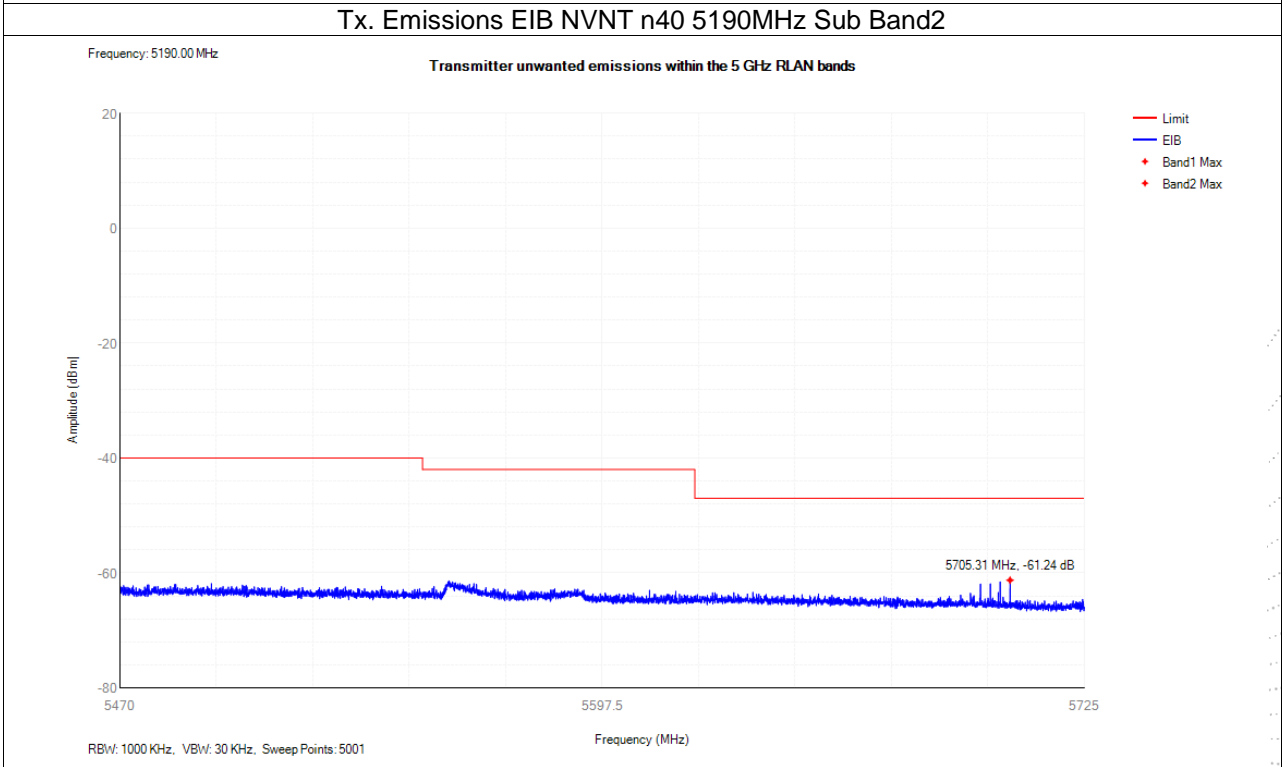
Tx. Emissions EIB NVNT n20 5180MHz Sub Band2

Tx. Emissions EIB NVNT n20 5200MHz Sub Band1

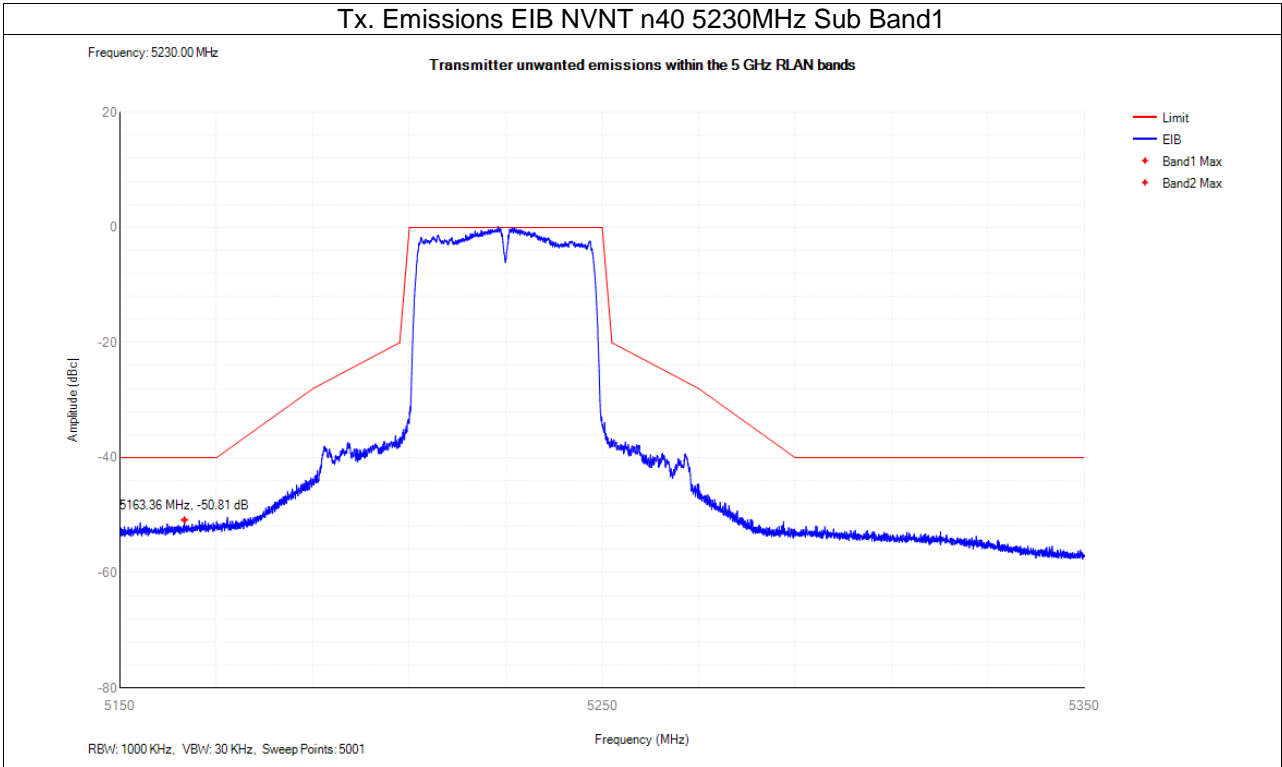
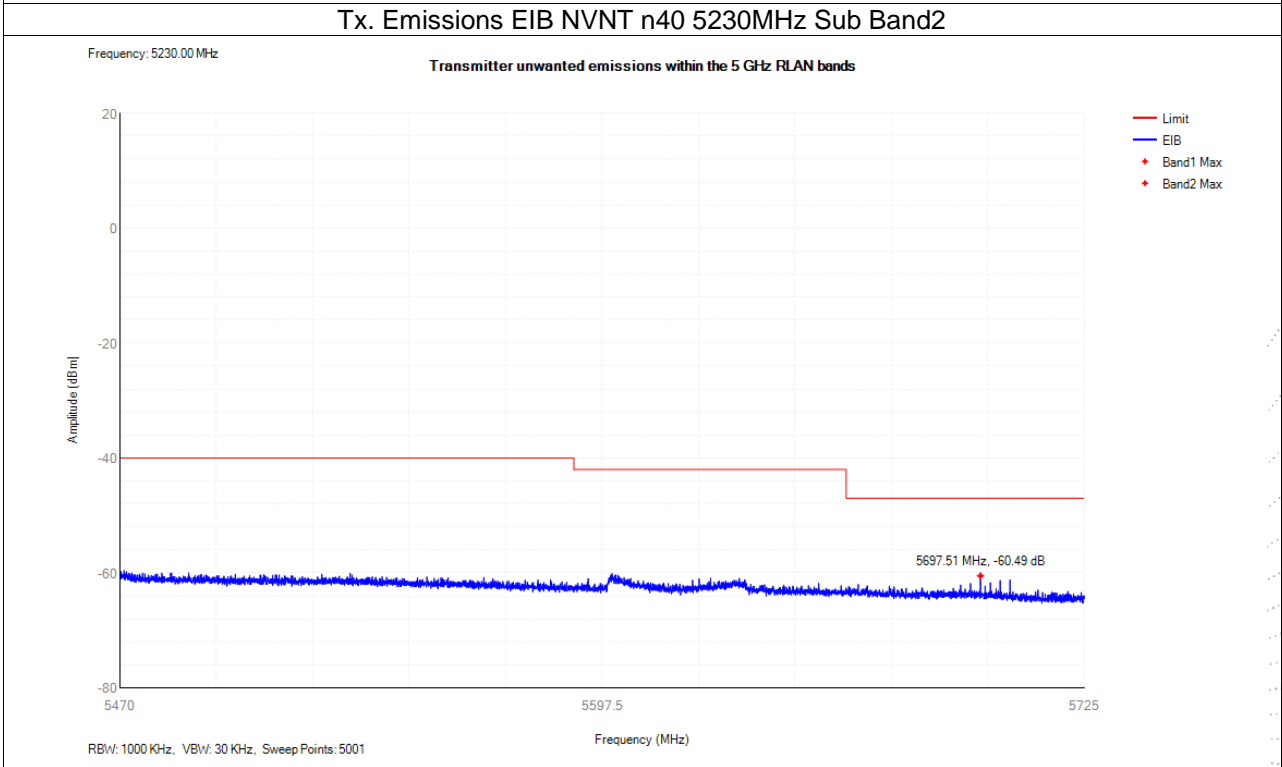
Tx. Emissions EIB NVNT n20 5200MHz Sub Band2

Tx. Emissions EIB NVNT n20 5240MHz Sub Band1

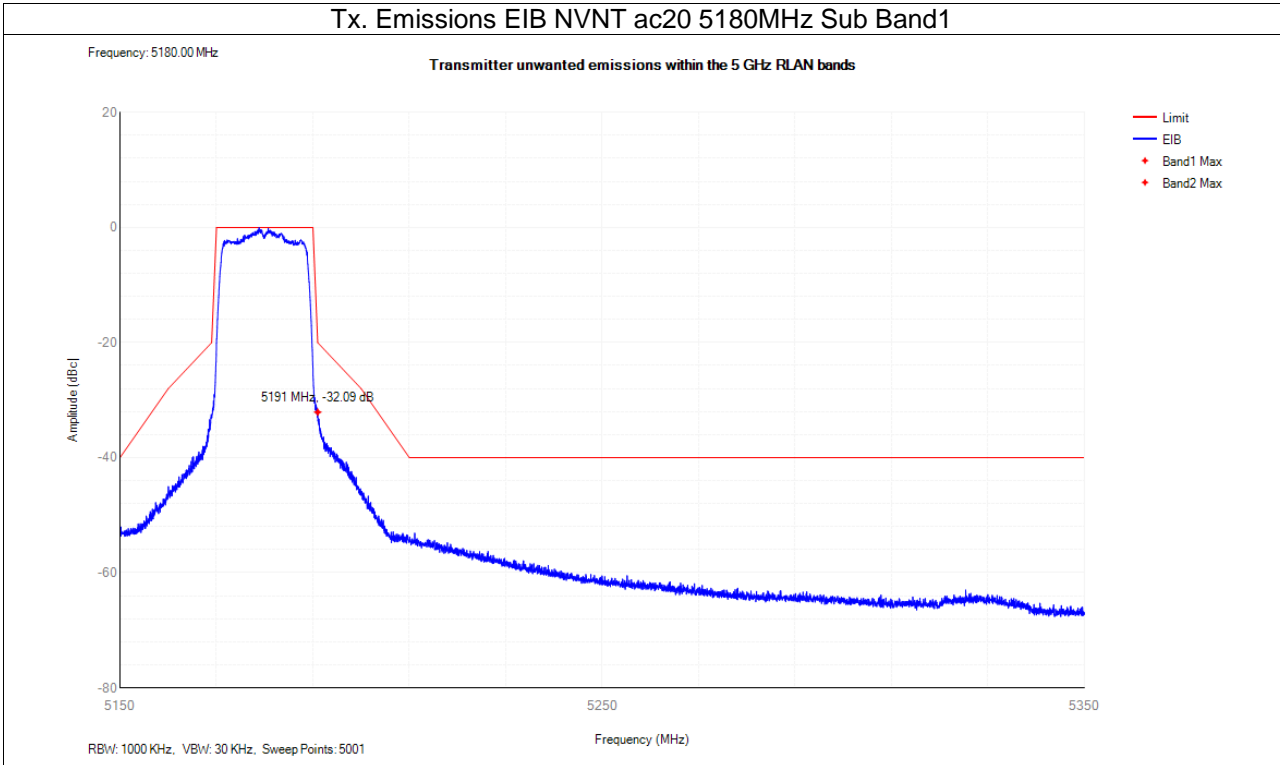
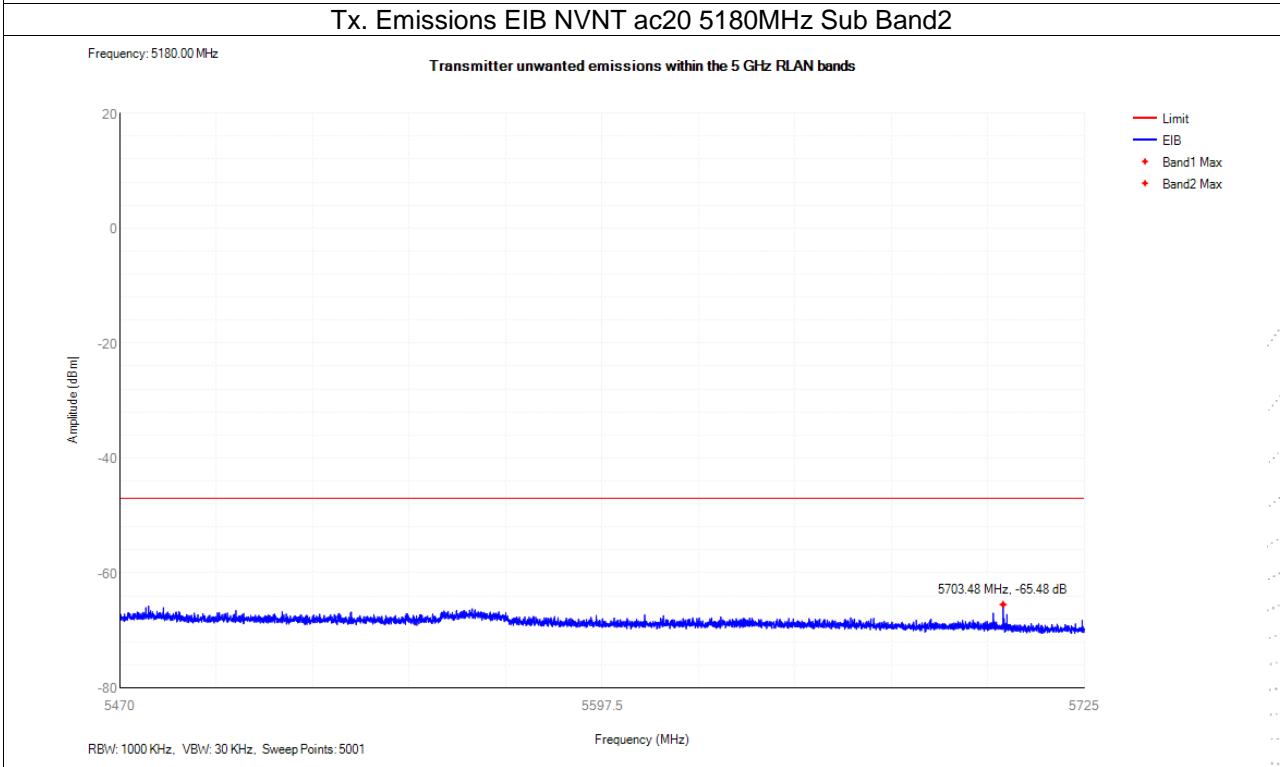
Tx. Emissions EIB NVNT n20 5240MHz Sub Band2

Tx. Emissions EIB NVNT n40 5190MHz Sub Band1

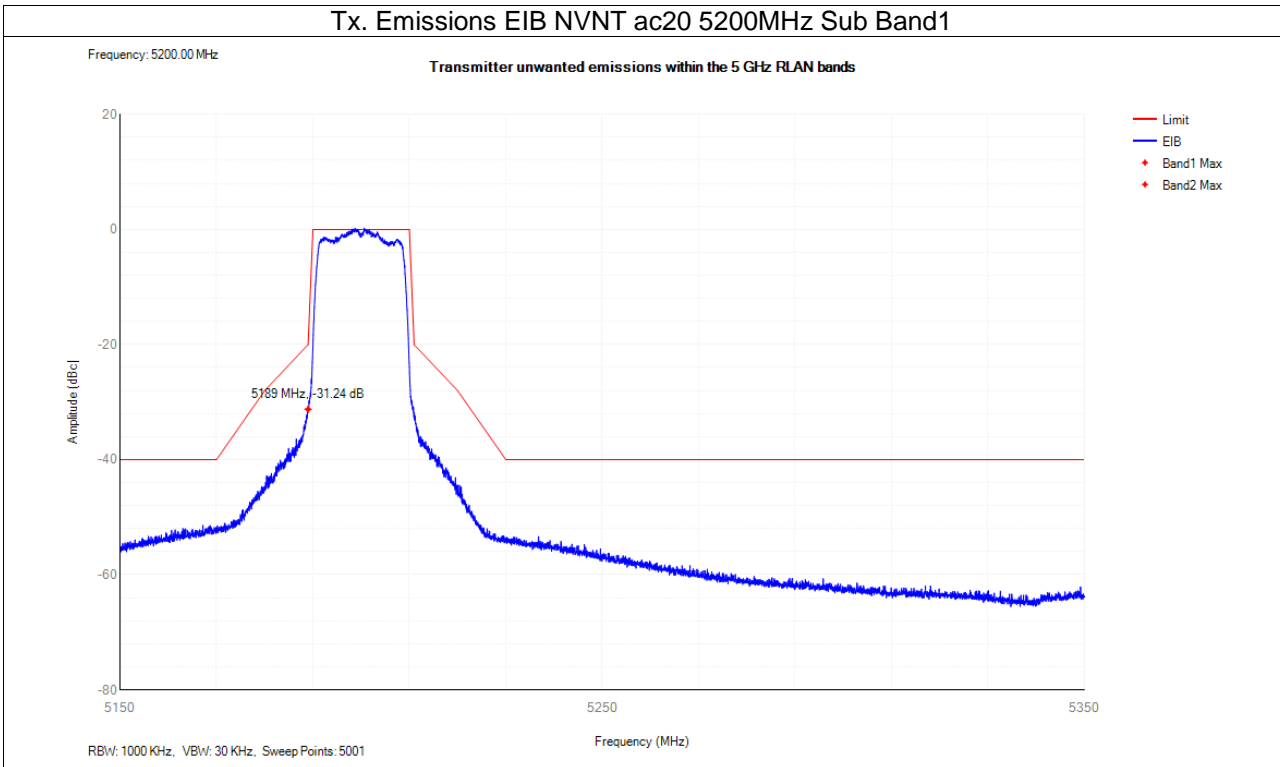
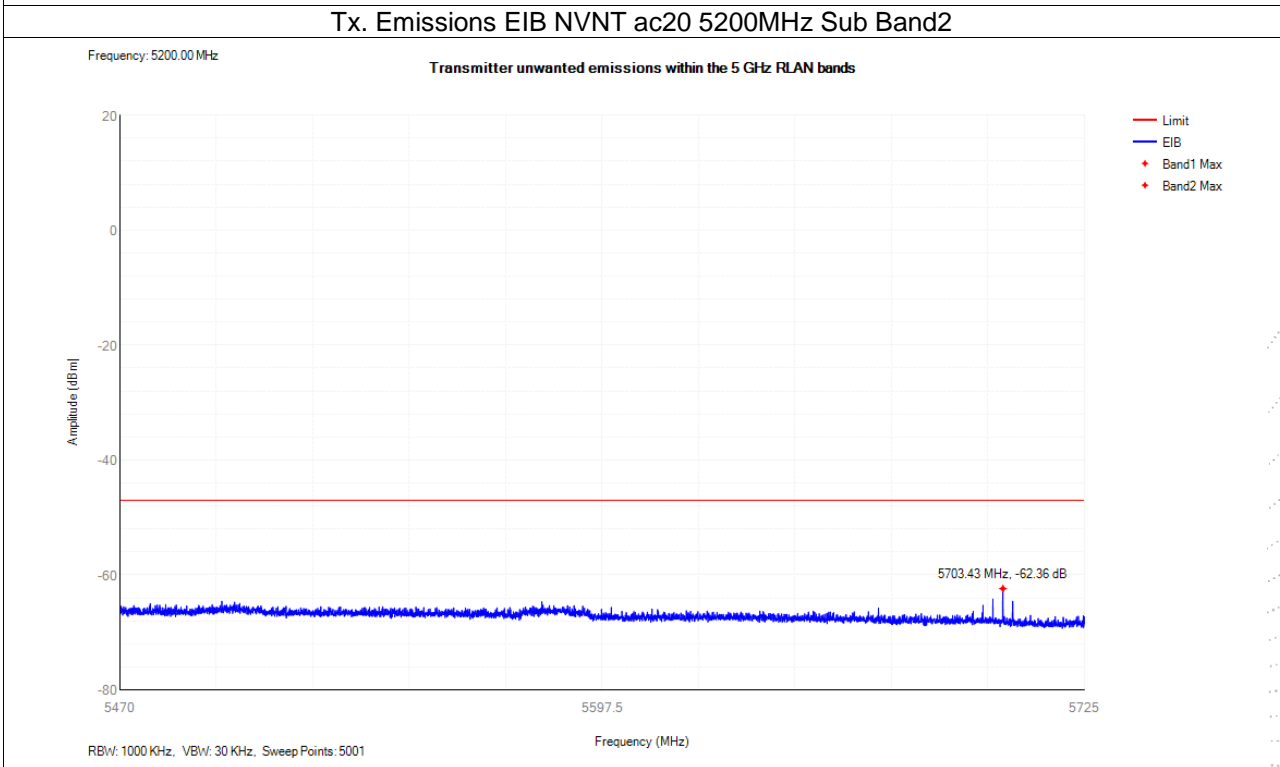
Tx. Emissions EIB NVNT n40 5190MHz Sub Band2

Tx. Emissions EIB NVNT n40 5230MHz Sub Band1

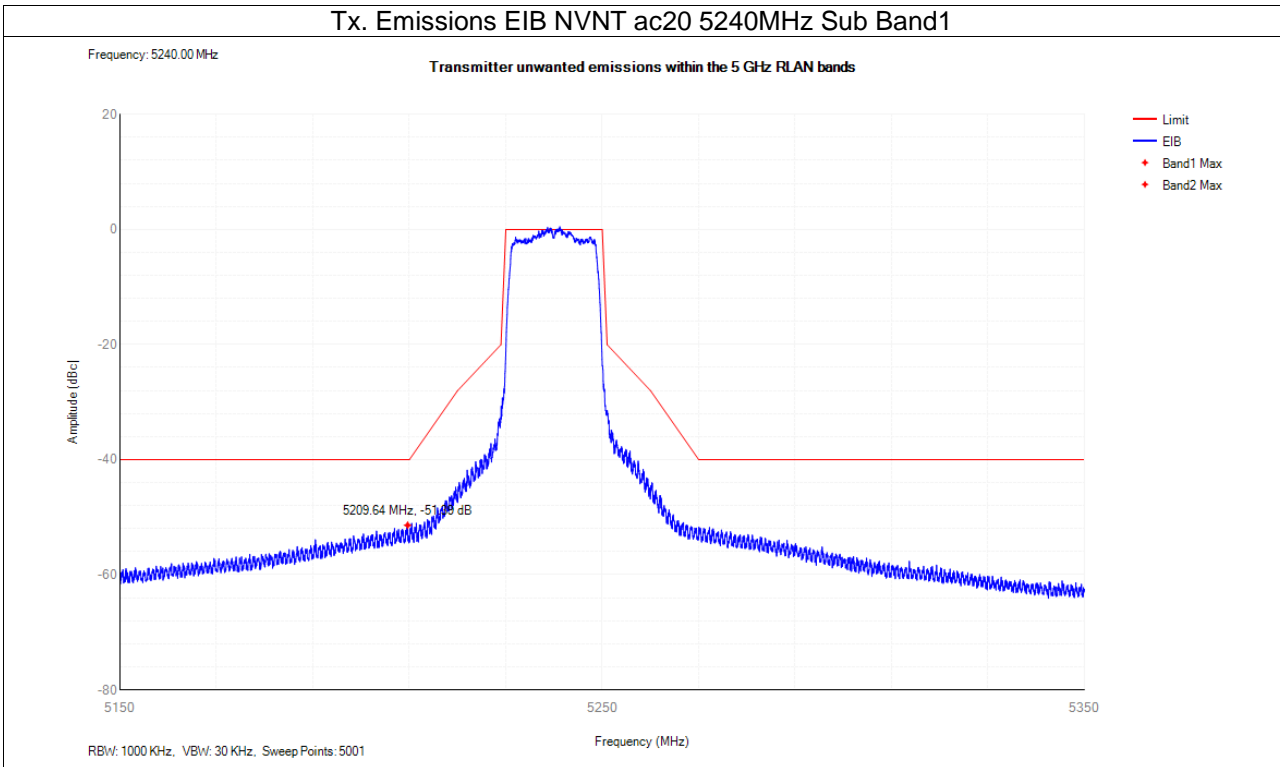
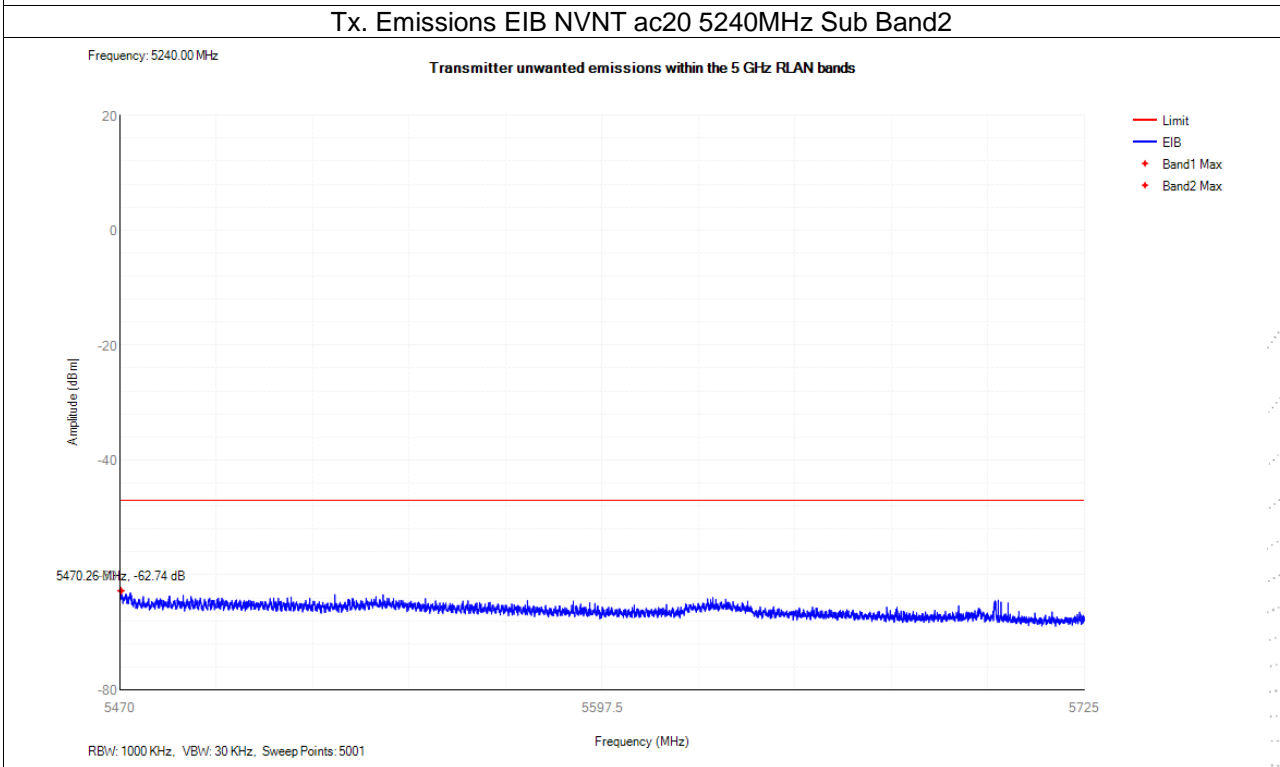
Tx. Emissions EIB NVNT n40 5230MHz Sub Band2

Tx. Emissions EIB NVNT ac20 5180MHz Sub Band1

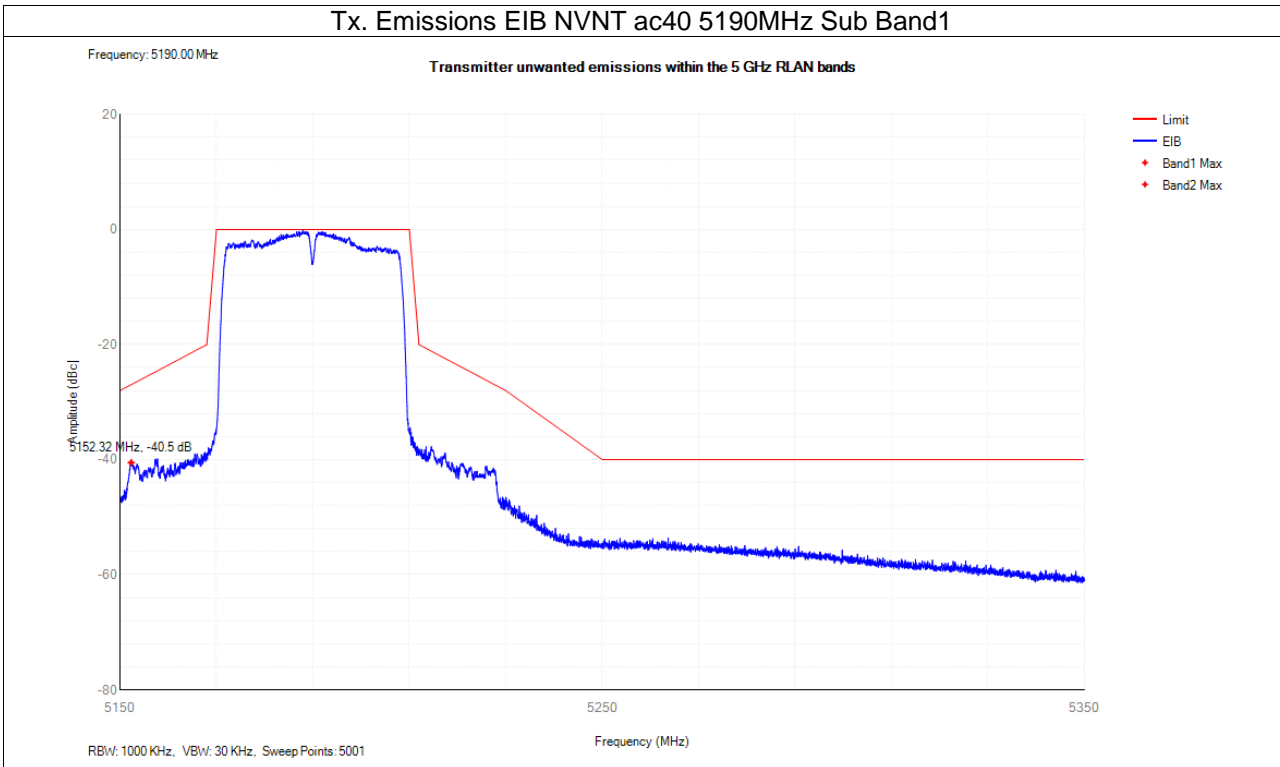
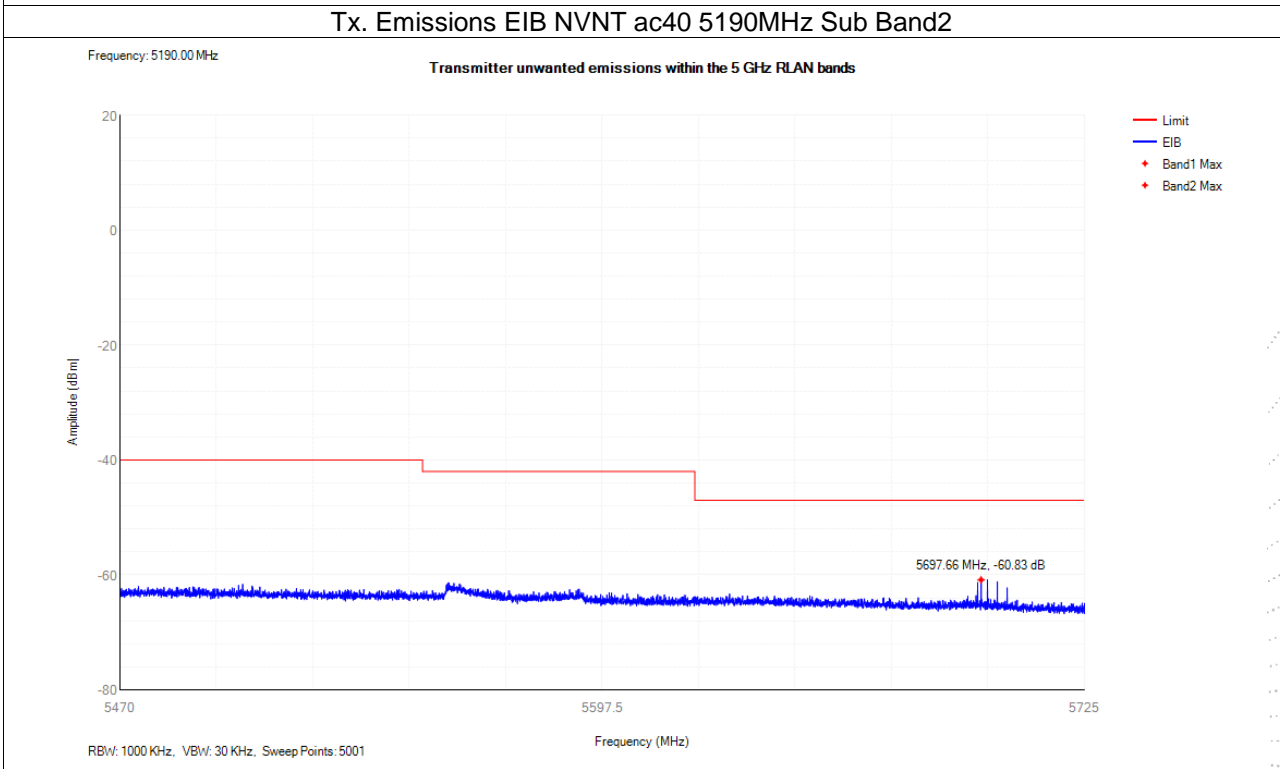
Tx. Emissions EIB NVNT ac20 5180MHz Sub Band2

Tx. Emissions EIB NVNT ac20 5200MHz Sub Band1

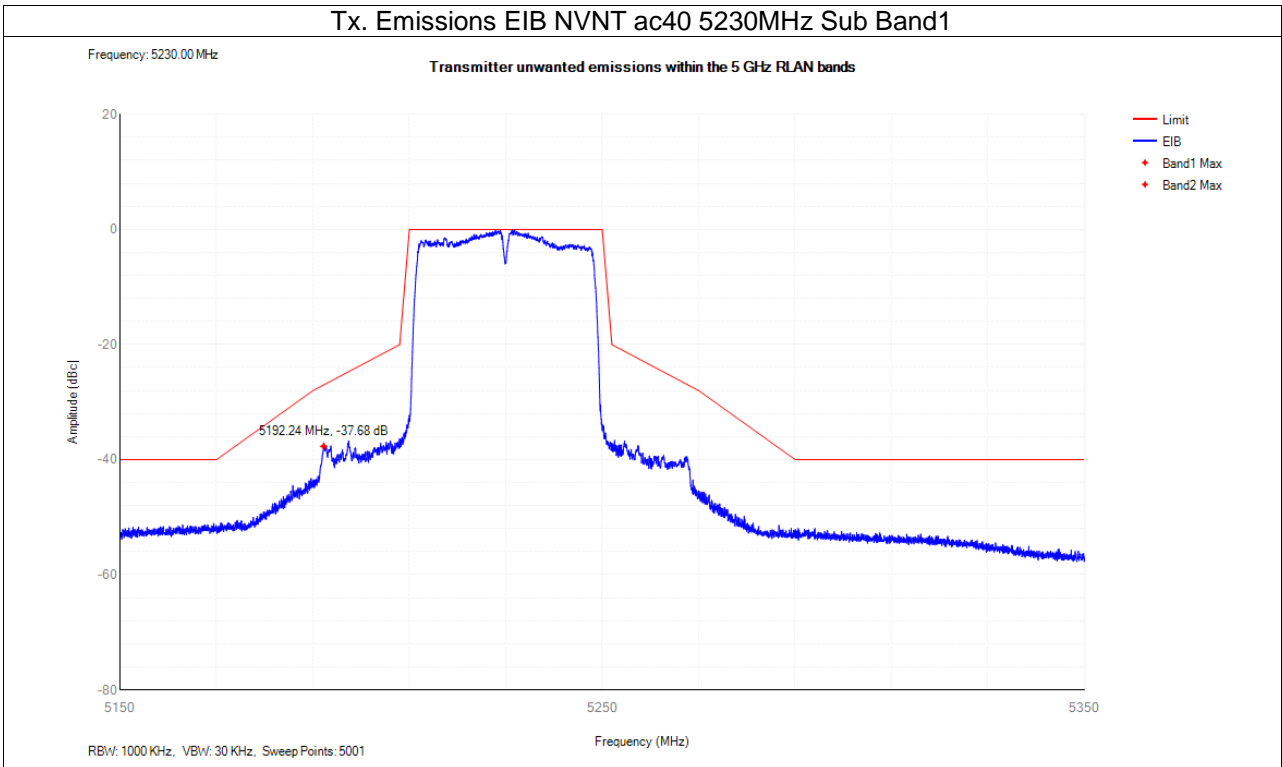
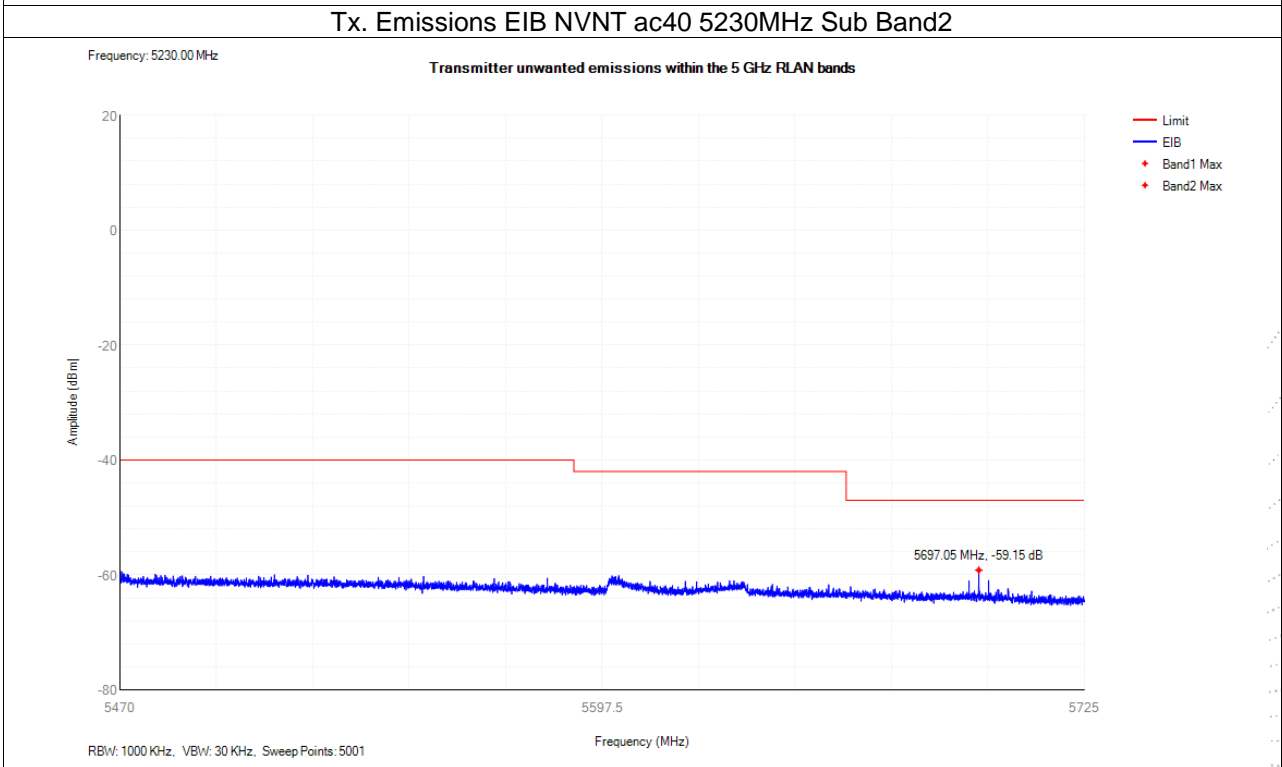
Tx. Emissions EIB NVNT ac20 5200MHz Sub Band2

Tx. Emissions EIB NVNT ac20 5240MHz Sub Band1

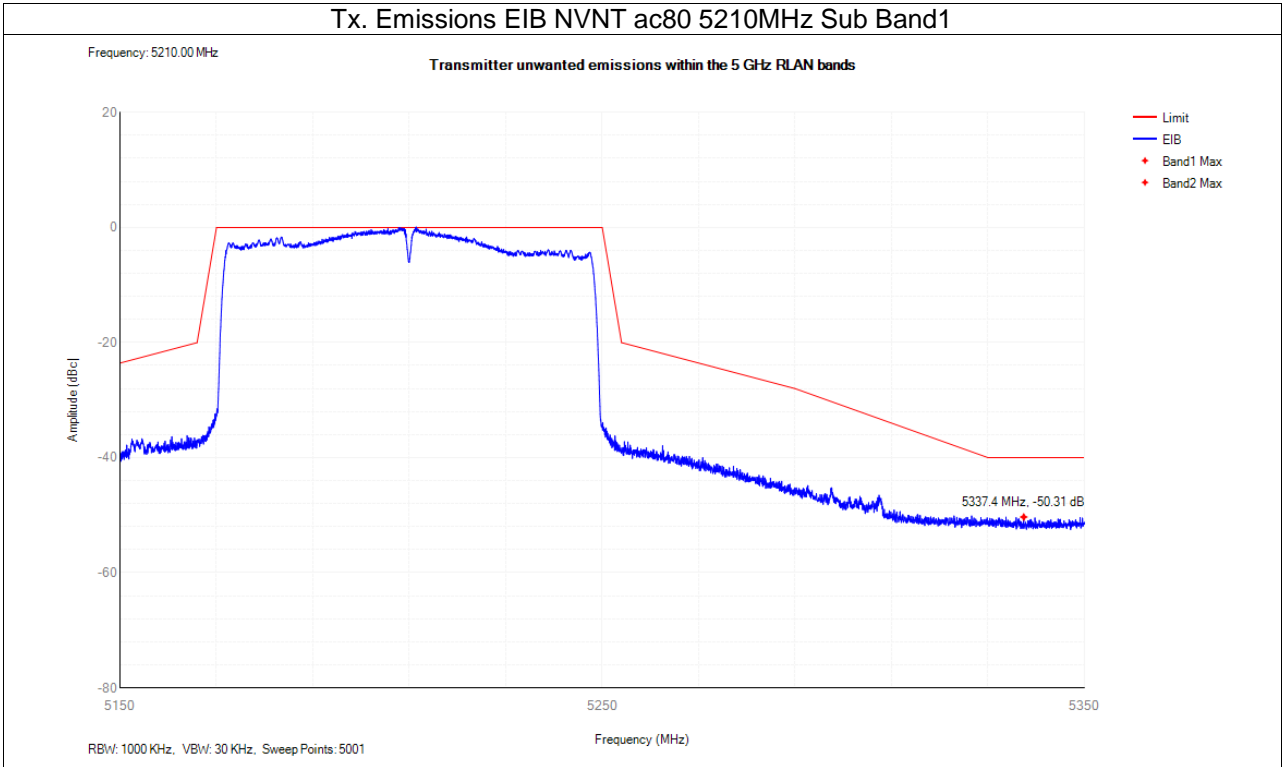
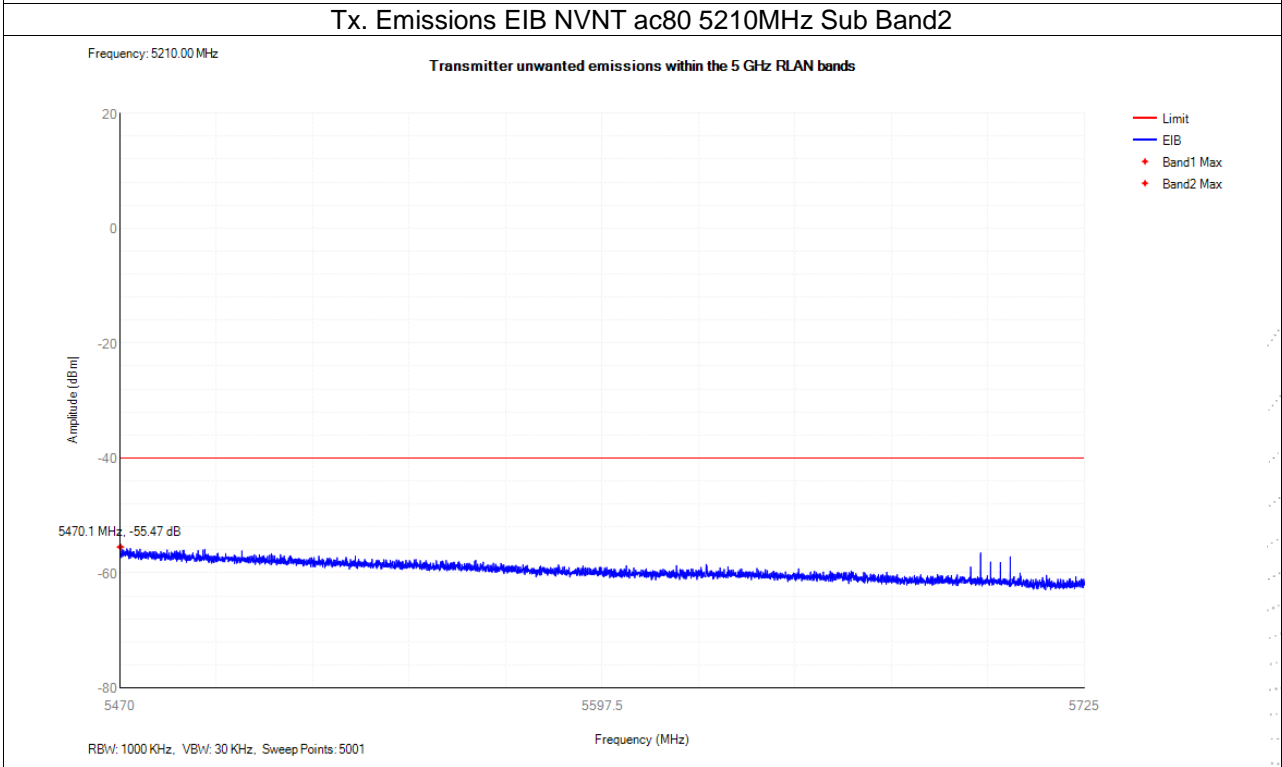
Tx. Emissions EIB NVNT ac20 5240MHz Sub Band2

Tx. Emissions EIB NVNT ac40 5190MHz Sub Band1

Tx. Emissions EIB NVNT ac40 5190MHz Sub Band2

Tx. Emissions EIB NVNT ac40 5230MHz Sub Band1

Tx. Emissions EIB NVNT ac40 5230MHz Sub Band2

Tx. Emissions EIB NVNT ac80 5210MHz Sub Band1

Tx. Emissions EIB NVNT ac80 5210MHz Sub Band2

13. Receiver Spurious Emissions

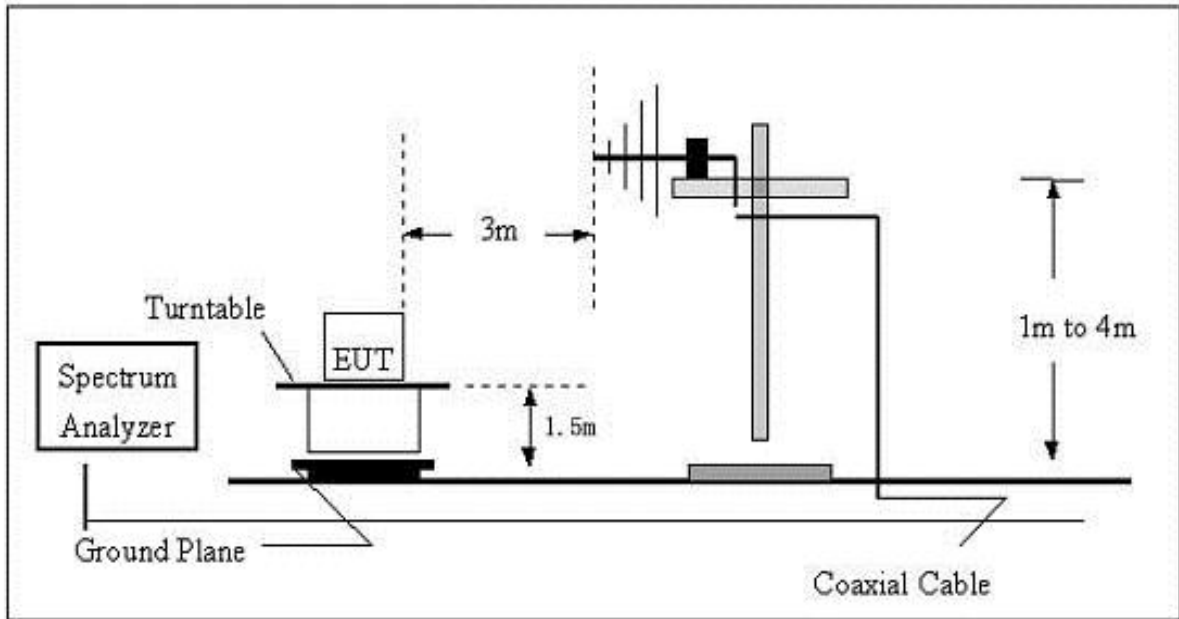
13.1 Block Diagram Of Test Setup

(A) Radiated Emission Test Set-Up Frequency Below 1GHz.



(B) Radiated Emission Test Set-Up Frequency Above 1GHz.

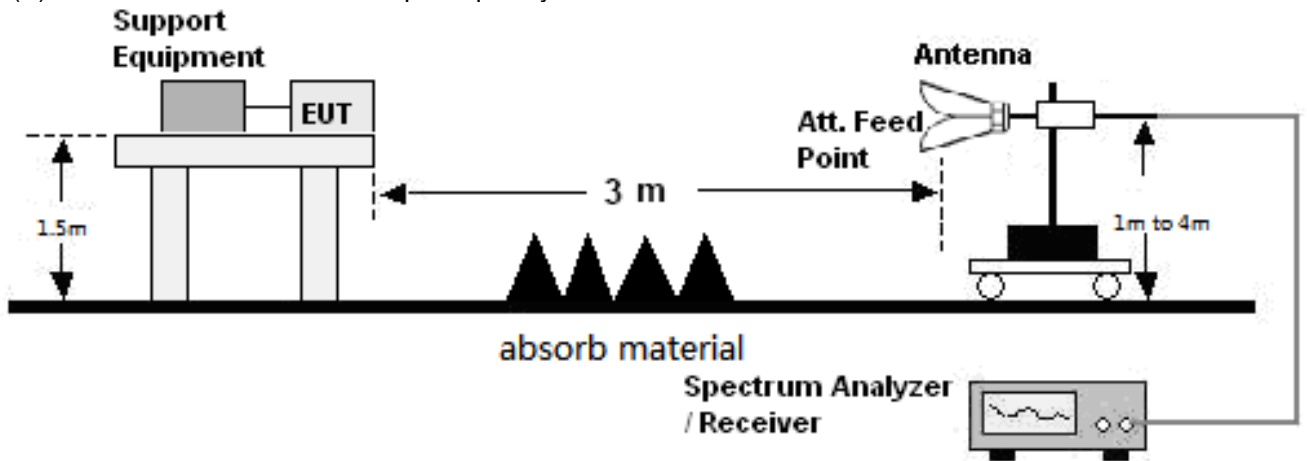

13.2 Limits

Frequency(MHz)	Limit
30-1000	-57dBm
1000-26000	-47dBm

13.3 Test Procedure

30MHz ~ 1GHz:

- a. The Product was placed on the nonconductive turntable 1.5m above the ground in a full anechoic chamber.
- b. Set the spectrum analyzer/receiver in Peak detector, Max Hold mode, and 120 kHz RBW. Record the maximum field strength of all the pre-scan process in the full band when the antenna is varied between 1~4 m in both horizontal and vertical, and the turntable is rotated from 0 to 360 degrees.
- c. For each frequency whose maximum record was higher or close to limit, measure its QP value: vary the antenna's height and rotate the turntable from 0 to 360 degrees to find the height and degree where Product radiated the maximum emission, then set the test frequency analyzer/receiver to QP Detector and specified bandwidth with Maximum Hold Mode, and record the maximum value.

Above 1GHz:

- a. The Product was placed on the non-conductive turntable 1.5 m above the ground in a full anechoic chamber..
- b. Set the spectrum analyzer/receiver in Peak detector, Max Hold mode, and 1MHz RBW. Record the maximum field strength of all the pre-scan process in the full band when the antenna is varied in both horizontal and vertical, and the turntable is rotated from 0 to 360 degrees.
- c. For each frequency whose maximum record was higher or close to limit, measure its AV value: rotate the turntable from 0 to 360 degrees to find the degree where Product radiated the maximum emission, then set the test frequency analyzer/receiver to AV value and specified bandwidth with Maximum Hold Mode, and record the maximum value.

13.4 Test Results

All modes have been tested and reports show data in the worst mode
 Test Mode: Transmitting 802.11n20 (worst case)

Frequency	Receiver Reading	Turn table Angle	RX Antenna		Correct	Absolute Level	Result	
			Height	Polar	Factor		Limit	Margin
(MHz)	(dBm)	Degree	(m)	(H/V)	(dBm)	(dBm)	(dBm)	(dB)
802.11n20 Low channel								
239.85	-52.05	280	1.8	H	-15.46	-67.52	-57.00	-10.52
239.85	-54.12	96	1.0	V	-15.46	-69.58	-57.00	-12.58
2395.84	-49.43	59	1.8	H	-6.70	-56.14	-47.00	-9.14
2395.84	-51.07	52	1.5	V	-6.70	-57.77	-47.00	-10.77
802.11n20 Mid channel								
239.85	-52.08	155	1.7	H	-15.46	-67.54	-57.00	-10.54
239.85	-54.04	161	1.1	V	-15.46	-69.50	-57.00	-12.50
2395.84	-49.45	51	1.8	H	-6.70	-56.16	-47.00	-9.16
2395.84	-51.31	105	1.9	V	-6.70	-58.02	-47.00	-11.02
802.11 n20 High channel								
239.85	-51.11	108	1.7	H	-15.46	-66.57	-57.00	-9.57
239.85	-54.61	285	1.4	V	-15.46	-70.07	-57.00	-13.07
2395.84	-50.03	320	1.1	H	-6.70	-56.73	-47.00	-9.73
2395.84	-51.87	13	1.0	V	-6.70	-58.57	-47.00	-11.57

14. Adaptivity

14.1 Block Diagram Of Test Setup

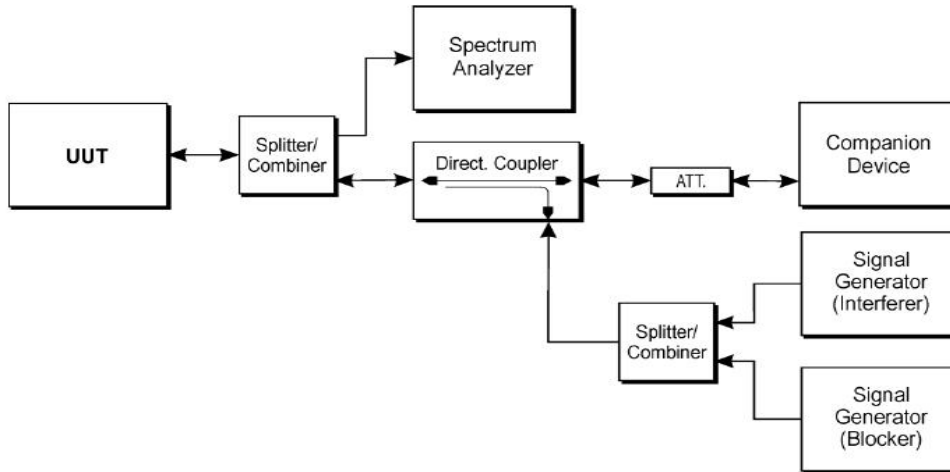

14.2 Limit

Requirement	Operational Mode		
	Frame Based Equipment	Load Based Equipment (CCA using 'energy detect')	Load Based Equipment (CCA not using any of the mechanisms referenced)
Minimum Clear Channel Assessment (CCA) Time	20 us (see note 1)	(see note 2)	20 us (see note 1)
Maximum Channel Occupancy (COT) Time	1ms to 10 ms	(see note 2)	(13/32)*q ms (see note 3)
Minimum Idle Period	5% of COT	(see note 2)	NA
Extended CCA check	NA	(see note 2)	N*CCA (see note 4)
Short Control Signalling Transmissions	Maximum duty cycle of 5% within an observation period of 50 ms (see note 5)		

Note 1: The CCA time used by the equipment shall be declared by the manufacturer.
 Note 2: LBT based spectrum sharing mechanism based on the Clear Channel Assessment (CCA) mode using 'energy detect', as described in IEEE 802.11TM-2007[9], clauses 15 and 17, in IEEE 802.11nTM -2009[10], clauses 20.
 Note 3: q is selected by the manufacturer in the range [4...32]
 Note 4: The value of N shall be randomly selected in the range [1...q]
 Note 5: Adaptive equipment may or may not have Short Control Signaling Transmissions.

14.3 Test procedure

Step 1:

- The UUT shall connect to a companion device during the test. The signal generator, the spectrum analyser, the UUT, the traffic source and the companion device are connected using a set-up equivalent to the example given by figure 14 although the interference source is switched off at this point in time. The spectrum analyser is used to monitor the transmissions of the UUT in response to the interference signal. The traffic source might be part of the UUT itself.
- The received signal level (wanted signal from the companion device) at the UUT shall be sufficient to maintain a reliable link for the duration of the test. A typical value for the received signal level which can be used in most cases is -50 dBm/MHz.
- The analyser shall be set as follows:
 - RBW: \geq Occupied Channel Bandwidth (if the analyser does not support this setting, the highest available setting shall be used)
 - VBW: \geq RBW (if the analyser does not support this setting, the highest available setting shall be used)
 - Detector Mode: RMS
 - Centre Frequency: Equal to the centre frequency of the operating channel
 - Span: 0 Hz
 - Sweep time: $> 2 \times$ Channel Occupancy Time
 - Trace Mode: Clear/Write
 - Trigger Mode: Video or RF/IF Power

Step 2:

- Configure the traffic source so that it fills the UUT's buffers to a level causing the UUT to always have transmissions queued (buffer-ready-for-transmission condition) towards the companion device. Where this is not possible, the UUT shall be configured to occupy the Channel Occupancy Time of the Fixed Frame Period to the highest extent possible.
- To avoid adverse effects on the measurement results, a unidirectional traffic source should be used. An example of such a unidirectional traffic source not triggering reverse traffic on higher layer protocols is UDP.

14.4 Test Result

Pass

15. Receiver Blocking

15.1 Block Diagram Of Test Setup

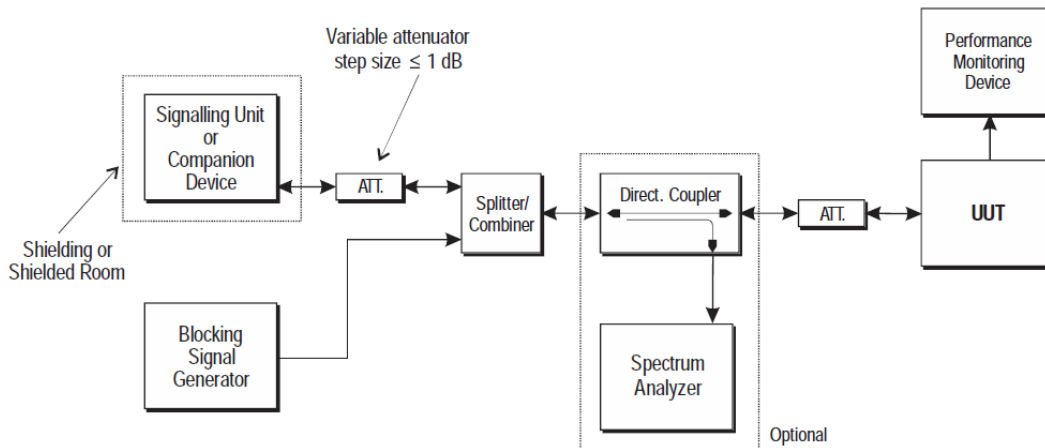

15.2 Limit

Wanted signal mean power from companion device (dBm)	Blocking signal frequency (MHz)	Blocking signal power (dBm) (see note 2)		Type of blocking signal
		Master or Slave with radar detection (see table D.2, note 2)	Slave without radar detection (see table D.2, note 2)	
$P_{min} + 6$ dB	5 100	-53	-59	Continuous Wave
$P_{min} + 6$ dB	4 900 5 000 5 975	-47	-53	Continuous Wave

NOTE 1: P_{min} is the minimum level of the wanted signal (in dBm) required to meet the minimum performance criteria as defined clause 4.2.8.3 in the absence of any blocking signal.

NOTE 2: The levels specified are levels in front of the UUT antenna. In case of conducted measurements, the same levels should be used at the antenna connector irrespective of antenna gain.

15.3 Test procedure

Step 1:

- The UUT shall be set to the first operating frequency to be tested (see clause 5.3.2).

Step 2:

- The blocking signal generator is set to the first frequency as defined in table 9.

Step 3:

- With the blocking signal generator switched off a communication link is set up between the UUT and the associated companion device using the test setup shown in figure 18. The attenuation of the variable attenuator shall be increased in 1 dB steps to a value at which the minimum performance criteria as specified in clause 4.2.8.3 is still met. The resulting level for the wanted signal at the input of the UUT is P_{min} .

- This signal level (P_{min}) is increased by 6 dB resulting in a new level ($P_{min} + 6$ dB) of the wanted signal at the UUT receiver input.

Step 4:

- The level of the blocking signal at the UUT input is set to the level provided in table 9. It shall be verified and recorded in the test report that the performance criteria as specified in clause 4.2.8.3 are met.
- If the performance criteria as specified in clause 4.2.8.3 are met, the level of the blocking signal at the UUT may be further increased (e.g. in steps of 1 dB) until the level whereby the performance criteria as specified in clause 4.2.8.3 are no longer met. The highest level at which the performance criteria are met is recorded in the test report.

Step 5:

- Repeat step 4 for each remaining combination of frequency and level as specified in table 9.

Step 6:

- Repeat step 2 to step 5 with the UUT operating at the other operating frequencies at which the blocking test has to be performed. See clause 5.3.2.

15.4 Test Result

All modes have been tested and reports show data in the worst mode

802.11 a	$P_{min}(dBm)$	Blocking Frequency(MHz)	Blocking Power(dB)	Measured PER(%)	Limit (%)
5180	-74	5100	-53	1.76	10
5180	-74	4900	-47	4.49	10
5180	-74	5000	-47	2.21	10
5180	-74	5975	-47	3.29	10
5240	-73	5100	-53	4.93	10
5240	-73	4900	-47	1.89	10
5240	-73	5000	-47	2.41	10
5240	-73	5975	-47	1.64	10

16. EUT Photographs

EUT Photo 1

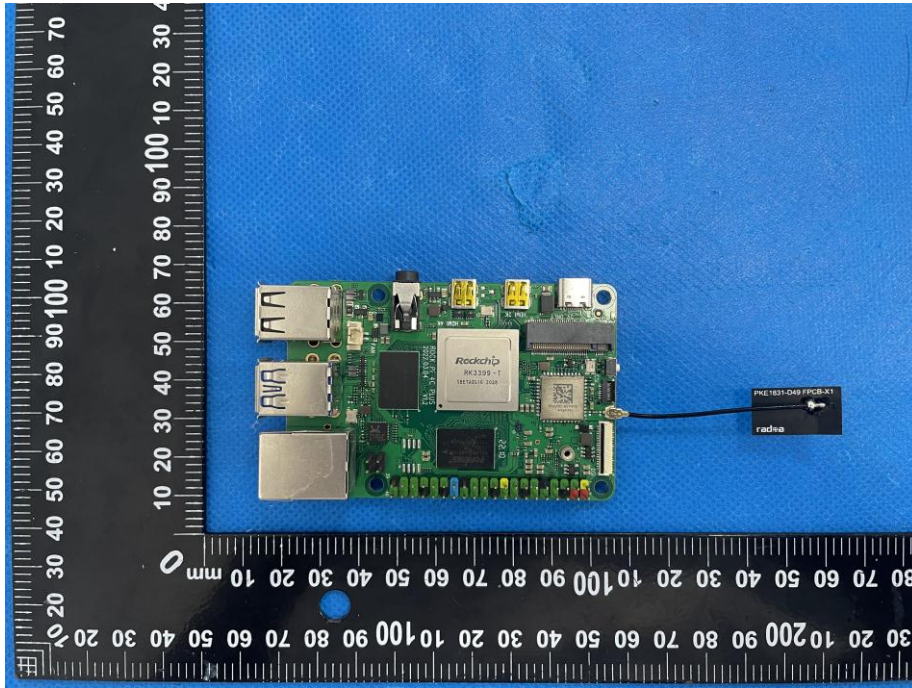

EUT Photo 2

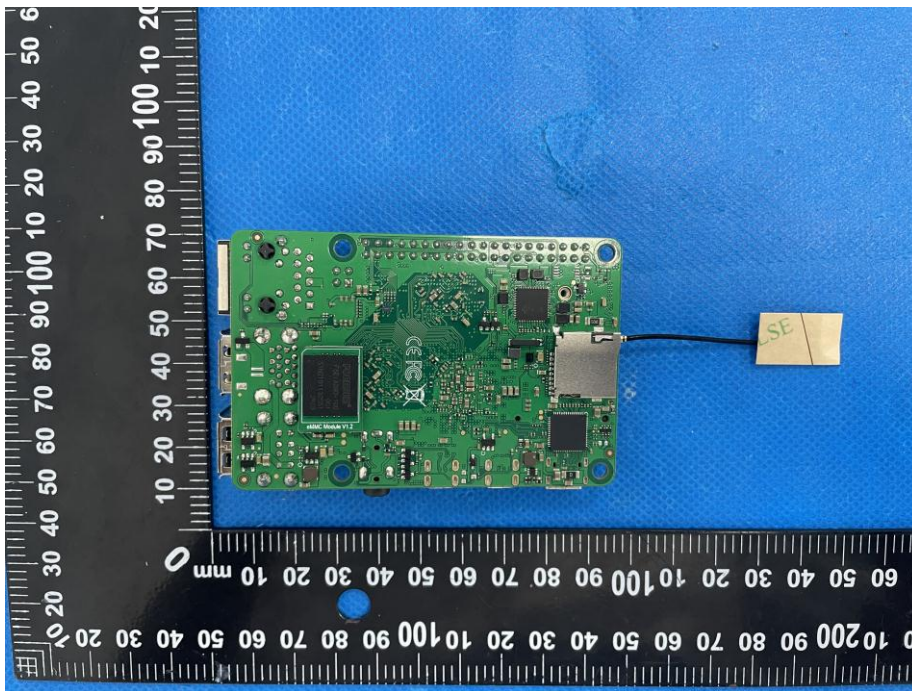

EUT Photo 3

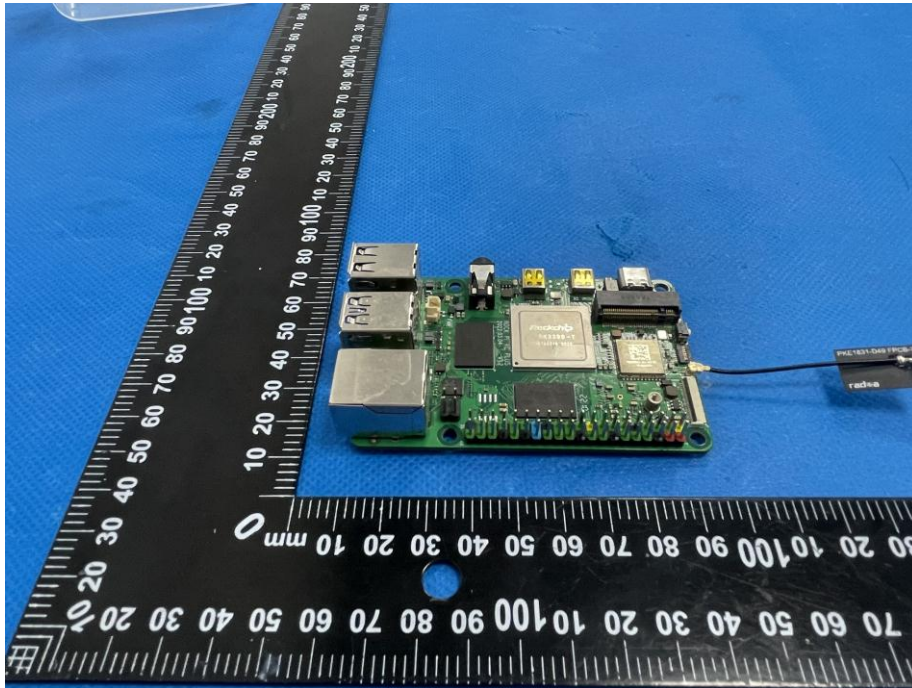

EUT Photo 4

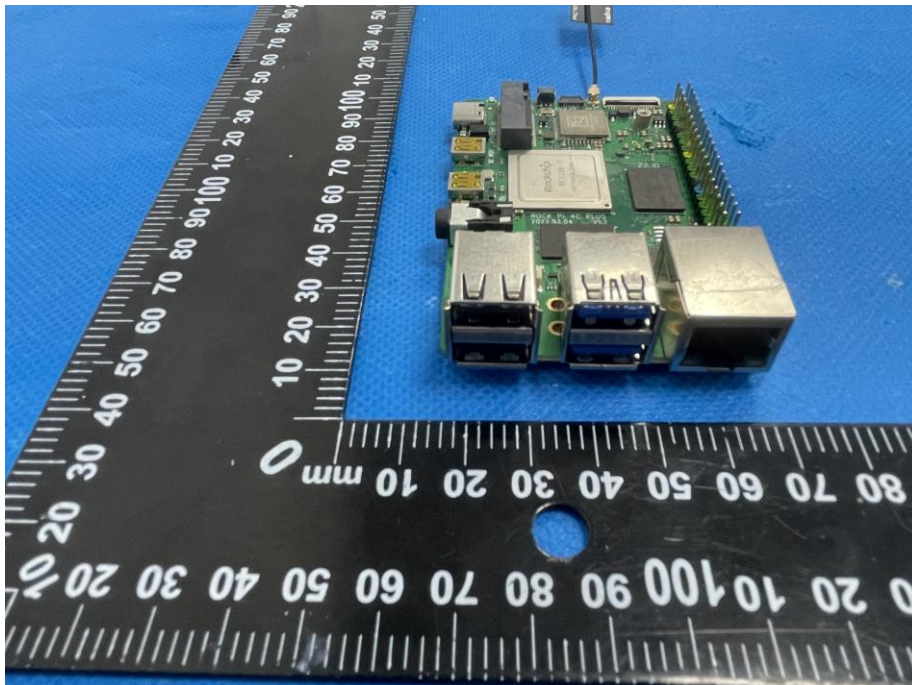

EUT Photo 5

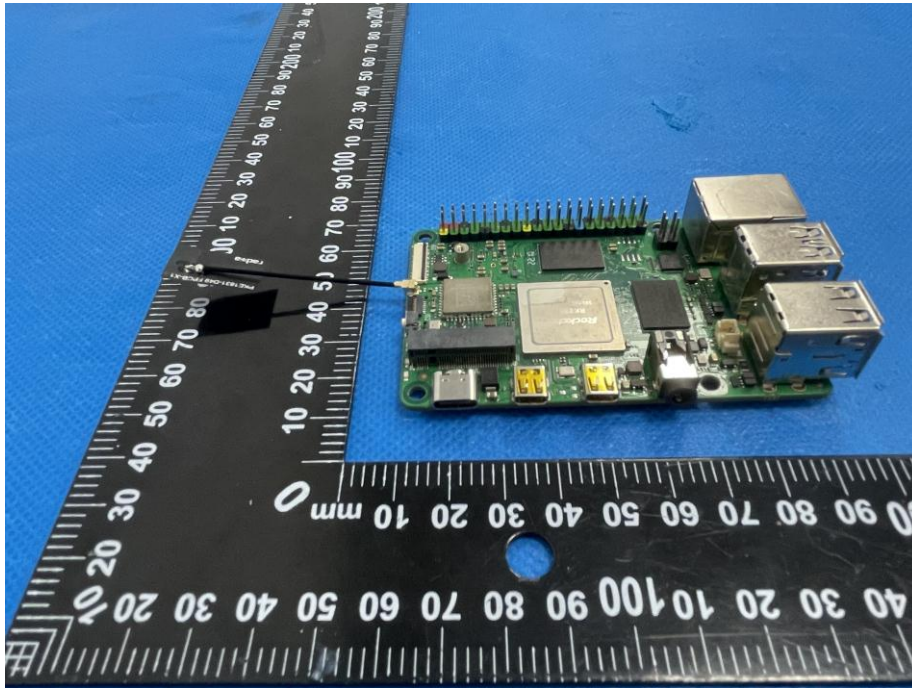

EUT Photo 6

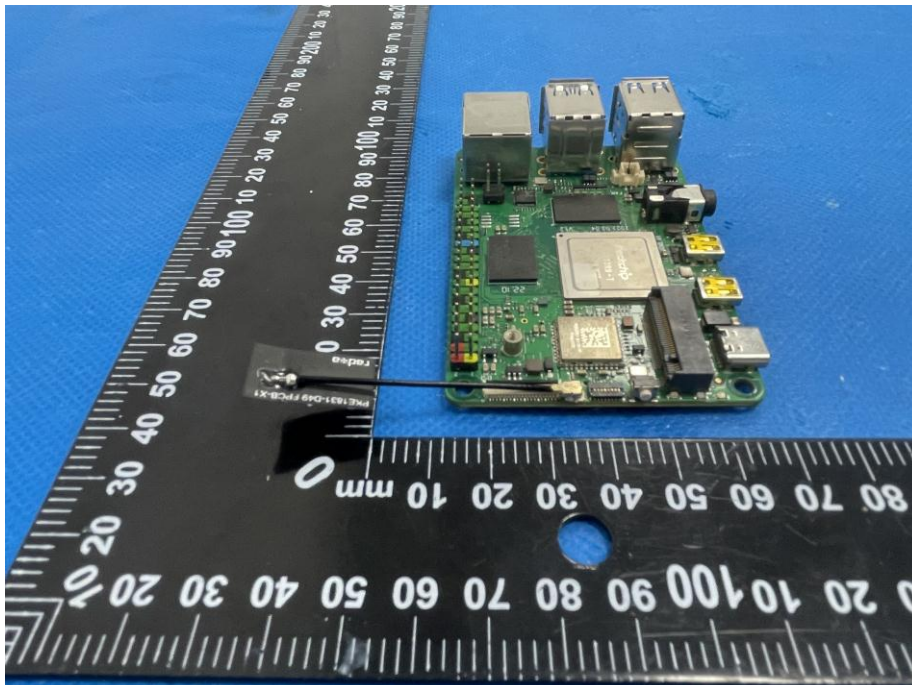

EUT Photo 7

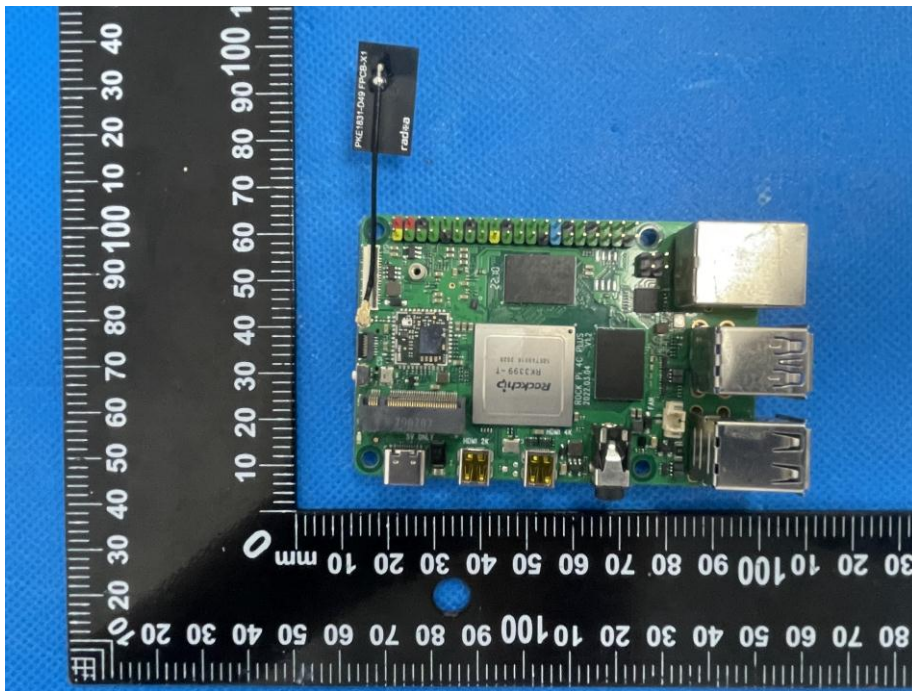

EUT Photo 8

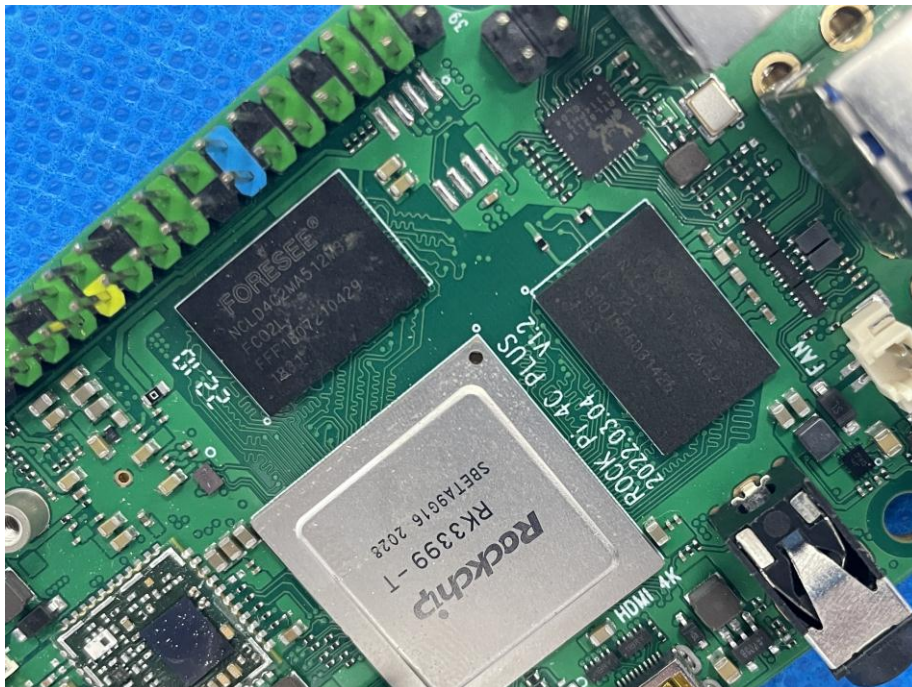

EUT Photo 9



EUT Photo 10

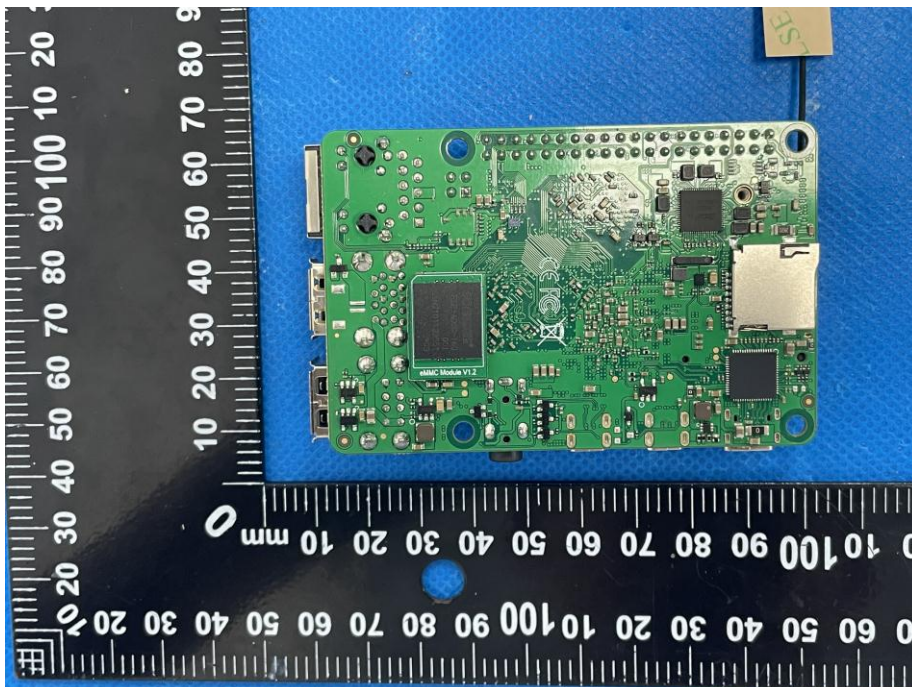

EUT Photo 11



EUT Photo 12

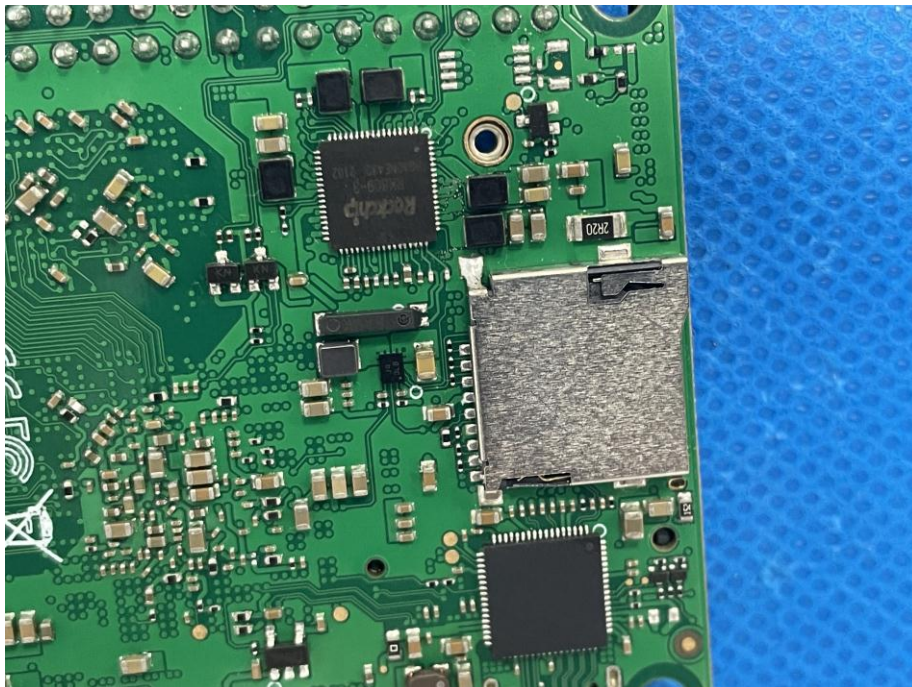

EUT Photo 13

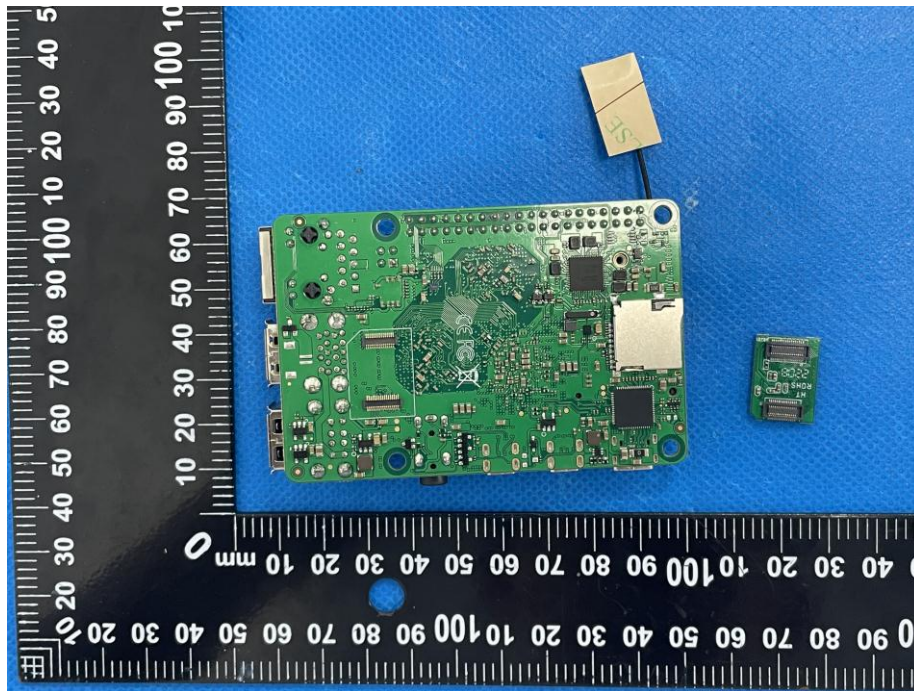

EUT Photo 14

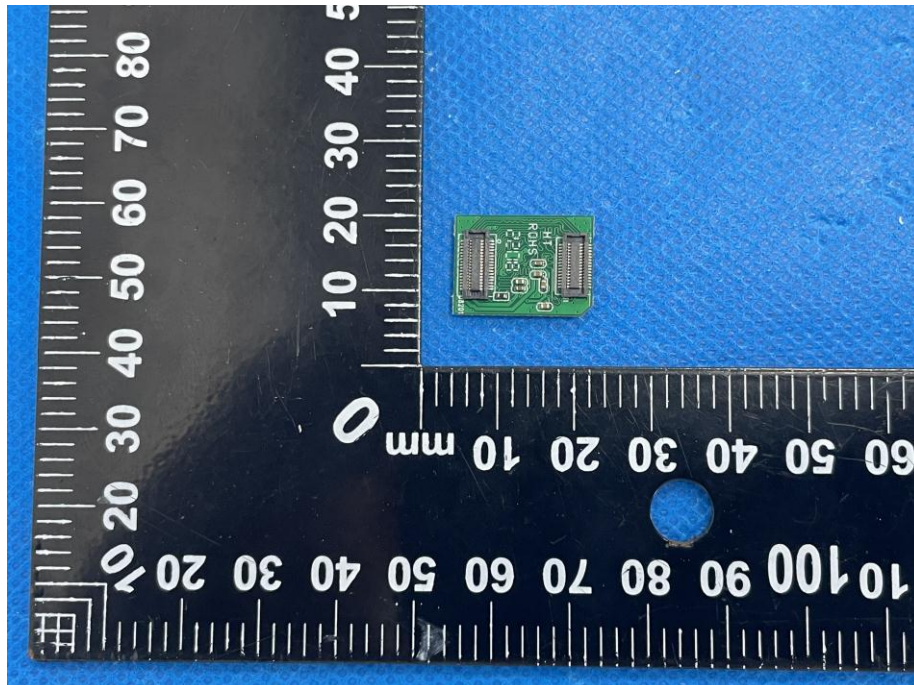

EUT Photo 15

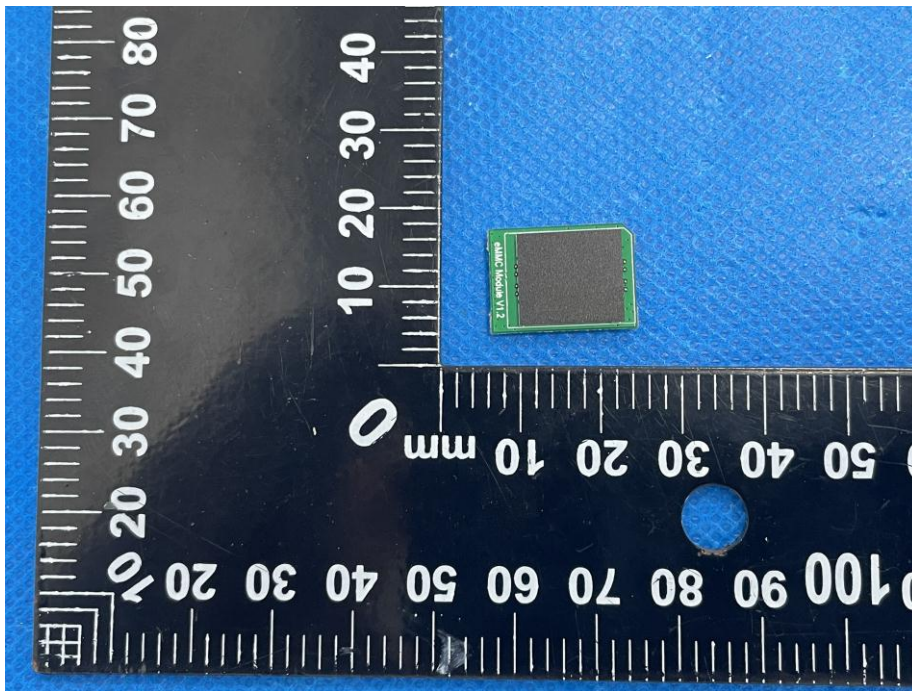

EUT Photo 16



17. EUT Test Setup Photographs



STATEMENT

1. The equipment lists are traceable to the national reference standards.
2. The test report can not be partially copied unless prior written approval is issued from our lab.
3. The test report is invalid without the "special seal for inspection and testing".
4. The test report is invalid without the signature of the approver.
5. The test process and test result is only related to the Unit Under Test.
6. Sample information is provided by the client and the laboratory is not responsible for its authenticity.
7. The test report without CMA mark is only used for scientific research, teaching, enterprise product development and internal quality control purposes.
8. The quality system of our laboratory is in accordance with ISO/IEC17025.
9. If there is any objection to this test report, the client should inform issuing laboratory within 15 days from the date of receiving test report.

Address:

1-2/F., Building B, Pengzhou Industrial Park, No.158, Fuyuan 1st Road, Zhancheng, Fuhai Subdistrict, Bao'an District, Shenzhen, Guangdong, China

TEL : 400-788-9558

P.C.: 518103

FAX : 0755-33229357

Website : <http://www.chnbctc.com>

E-Mail : bctc@bctc-lab.com.cn

***** END *****