

TEST REPORT

Report No.: BCTC2210401068-3E

Applicant: OKdo Technology Limited

Product Name: ROCK Pi 4/ROCK 4

Model/Type Ref.: ROCK 4C Plus

Tested Date: 2022-10-21 to 2022-12-06

Issued Date: 2022-12-06

Shenzhen BCTC Testing Co., Ltd.



Product Name: ROCK 4C Plus
ROCK Pi 4C Plus, ROCK Pi 4C Pro, ROCK Pi 4C Max, ROCK 4C,
ROCK 4C Pro, ROCK 4C Max

Trademark: N/A

Model/Type Ref.: ROCK 4C Plus

Prepared For: OKdo Technology Limited

Address: 5th Floor, 2 Pancras Square, King's Cross, London N1C 4AG, United Kingdom

Manufacturer: OKdo Technology Limited

Address: 5th Floor, 2 Pancras Square, King's Cross, London N1C 4AG, United Kingdom

Prepared By: Shenzhen BCTC Testing Co., Ltd.

Address: 1-2/F., Building B, Pengzhou Industrial Park, No.158, Fuyuan 1st Road, Zhancheng,
Fuhai Subdistrict, Bao'an District, Shenzhen, Guangdong, China

Sample Received Date: 2022-10-21

Sample tested Date: 2022-10-21 to 2022-12-06

Issue Date: 2022-12-06

Report No.: BCTC2210401068-3E

Test Standards: ARIB STD T-66 Ver.3.7
Article 2 paragraph 1 of item 19

Test Results: PASS

Remark: This is JAPAN RADIO test report.

Tested by:

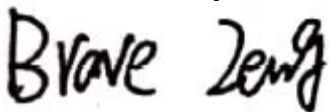

Brave Zeng/ Project Handler

Approved by:



Zero Zhou/Reviewer

The test report is effective only with both signature and specialized stamp. This result(s) shown in this report refer only to the sample(s) tested. Without written approval of Shenzhen BCTC Testing Co., Ltd, this report can't be reproduced except in full. The tested sample(s) and the sample information are provided by the client.

Table Of Content

Test Report Declaration	Page
1. Version	5
2. Test Summary	6
3. Measurement Uncertainty	7
4. Product Information And Test Setup	8
4.1 Product Information.....	8
4.2 Block Diagram Parameters Of Test Software Setting	8
4.3 Description Of Support Units (Conducted Mode)	8
4.4 Channel List.....	9
4.5 Test Mode	9
4.6 Test Conditions	10
4.7 Table Of Parameters Of Test Software Setting	10
5. Test Facility And Test Instrument Used.....	11
5.1 Test Facility.....	11
5.2 Test Instrument Used.....	11
6. RF Shielding Method.....	12
7. Frequency Error	13
7.1 Block Diagram Of Test Setup.....	13
7.2 Limit	13
7.3 Measuring Instruments And Setting	13
7.4 Test Procedure	13
7.5 Test Result.....	14
8. Antenna Power.....	16
8.1 Block Diagram Of Test Setup.....	16
8.2 Limit	16
8.3 Test Procedure	16
8.4 Test Result.....	17
9. Occupied Bandwidth And Spread-Spectrum Bandwidth Measurement.....	27
9.1 Block Diagram Of Test Setup.....	27
9.2 Limit	27
9.3 Test Procedure	27
9.4 Test Result.....	28
10. Unwanted Emission Intensity Measurement.....	38
10.1 Block Diagram Of Test Setup.....	38
10.2 Limit	38
10.3 Measuring Instruments And Setting	38
10.4 Test Procedure	38
10.5 Test Result.....	40
11. Imitation Of Collateral Emission Of Receiver Measurement.....	63
11.1 Block Diagram Of Test Setup.....	63
11.2 Limit	63
11.3 Measuring Instruments And Setting	63
11.4 Test Procedure	63
11.5 Test Result.....	64

12. Transmission Antenna Gain (EIRP Antenna Power) Measurement	67
12.1 Block Diagram Of Test Setup.....	67
12.2 Limit	67
12.3 Measuring Instruments And Setting	68
12.4 Test Procedure	68
12.5 Test Result.....	69
13. Transmission Radiation Angle Width (3db Beamwidth) Measurement.....	70
13.1 Block Diagram Of Test Setup.....	70
13.2 Limit	70
13.3 Measuring Instruments And Setting	70
13.4 Test Procedure	71
13.5 Test Result.....	71
14. Radio Interference Prevention Capability Measurement	72
14.1 Block Diagram Of Test Setup.....	72
14.2 Limit	72
14.3 Measuring Instruments And Setting	72
14.4 Test Procedure	72
14.5 Test Result.....	72
15. Carrier Sense Capability Measurement.....	73
15.1 Block Diagram Of Test Setup.....	73
15.2 Limit	73
15.3 Test Procedure	73
15.4 Test Result.....	73
16. Duty Cycle Of Test Signal	74
16.1 Standard Requirement	74
16.2 Formula.....	74
16.3 Test Procedure	74
16.4 Test Result.....	74
17. EUT Photographs.....	77
18. EUT Test Setup Photographs.....	79

(Note: N/A Means Not Applicable)

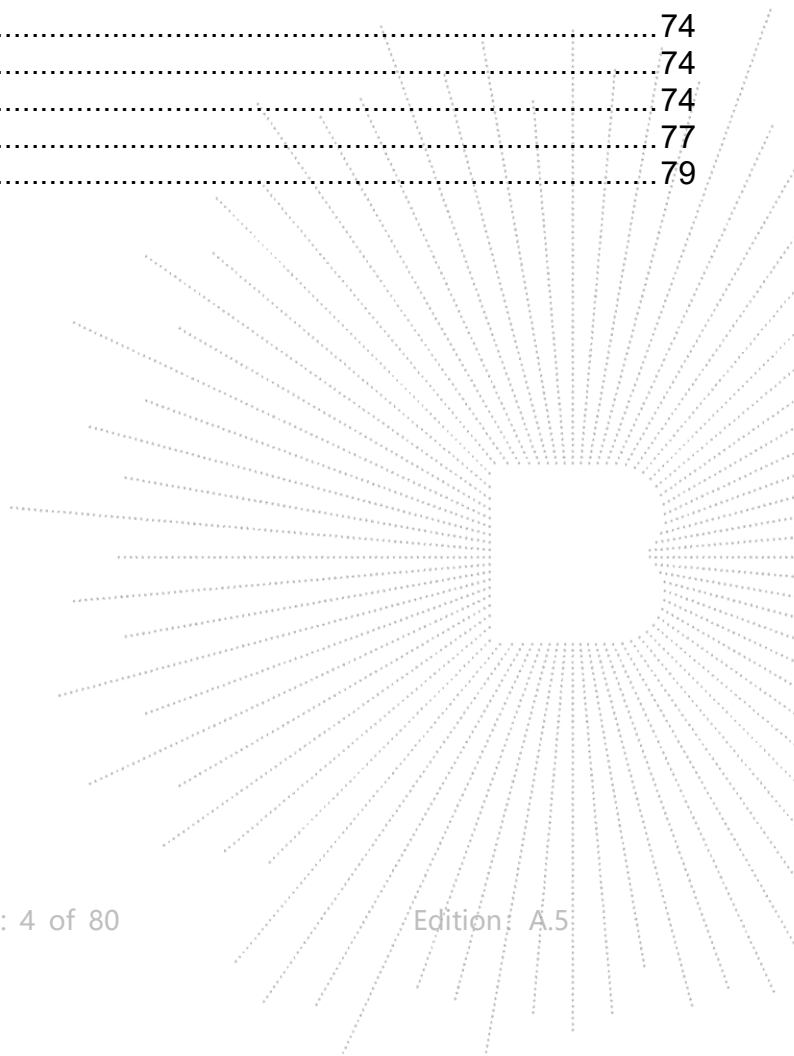

1. Version

Report No.	Issue Date	Description	Approved
BCTC2210401068-3E	2022-12-06	Original	Valid

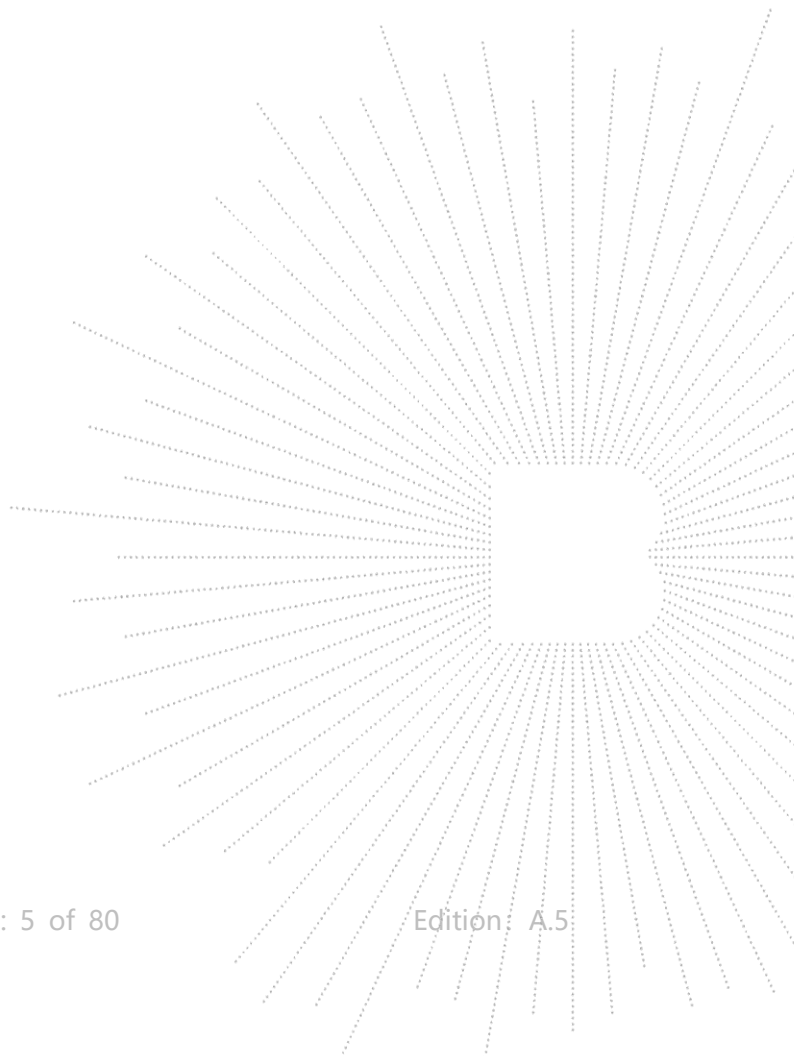

2. Test Summary

Test procedures according to the technical standards:

Article 2 paragraph 1 of item 19	
Description of Test	Result
Frequency Error	Complies
Occupied Bandwidth (99%) and Spread-spectrum Bandwidth (90%)	Complies
Unwanted Emission Intensity	Complies
Antenna Power Error	Complies
Limitation of Collateral Emission of Receiver	Complies
Transmission Antenna Gain (EIRP Antenna Power)	Complies
Transmission Radiation Angle Width (3Db Bandwidth)	N/A
Radio Interference Prevention Capability	Complies
Carrier Sense Capability	N/A
Construction Protection Confirmation	Complies

NOTE:

(1) "N/A" denotes test is not applicable in this Test Report

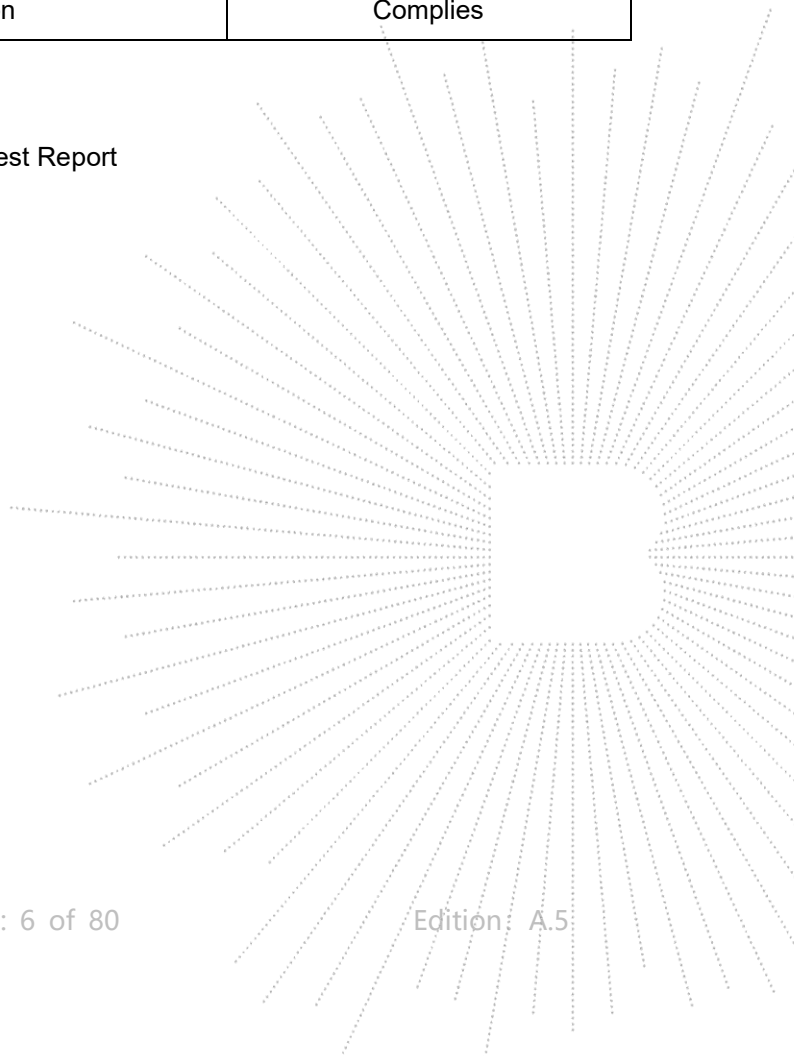

3. Measurement Uncertainty

The reported uncertainty of measurement $y \pm U$, where expanded uncertainty U is based on a standard uncertainty multiplied by a coverage factor of $k=2$, providing a level of confidence of approximately 95 %.

No.	Item	Uncertainty
1	Conducted Emission Test	$\pm 3.2\text{dB}$
2	Radiated Emission Test	$\pm 4.7\text{dB}$
3	RF power, conducted	$\pm 0.16\text{dB}$
4	Spurious emissions, conducted	$\pm 0.21\text{dB}$
5	All emissions, radiated(<1G)	$\pm 4.68\text{dB}$
6	All emissions, radiated(>1G)	$\pm 5.0\text{dB}$
7	frequency error ppm	$\pm 0.5\text{ppm}$

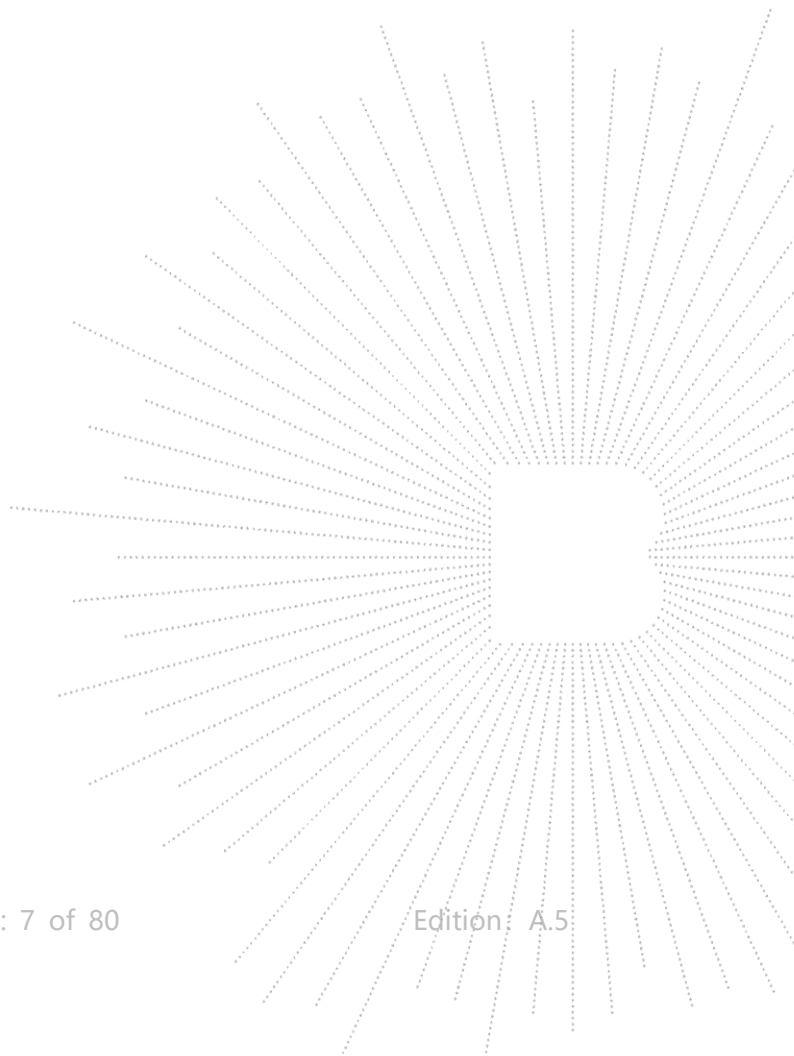

4. Product Information And Test Setup

4.1 Product Information

Model/Type Ref.:	ROCK 4C Plus ROCK Pi 4C Plus, ROCK Pi 4C Pro, ROCK Pi 4C Max, ROCK 4C, ROCK 4C Pro, ROCK 4C Max
Model differences:	All the model are the same circuit and RF module, except model names.
Hardware Version:	V1.0
Software Version:	V1.0
Operation Frequency:	IEEE 802.11b/g/n HT20: 2412-2472MHz
Rated RF Output Power Density	802.11b:3mW/MHz, 802.11g:3mW/MHz 802.11nHT20:2mW/MHz,
Conducted Power Density	802.11b: 2.899 mW/MHz, 802.11g: 2.496 mW/MHz, 802.11nHT20: 1.852 mW/MHz
Type of Modulation:	DSSS/OFDM
Bit Rate of Transmitter	802.11b: 11/5.5/2/1Mbps 802.11g: 54/48/36/24/18/12/9/6Mbps 802.11n: Up to 75Mbps
channel space	5MHz
Number Of Channel:	13 Channels for 802.11b/g/n(HT20)
Antenna installation:	FPC antenna
Antenna Gain:	-7.23 dBi
Ratings:	DC 5V from adapter

4.2 Block Diagram Parameters Of Text Software Setting

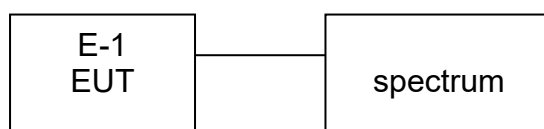

4.3 Description Of Support Units (Conducted Mode)

Item	Equipment	Mfr/Brand	Model/Type No.	Series No.	Note
E-1	ROCK Pi 4/ROCK 4	N/A	ROCK 4C Plus	N/A	EUT

Notes:

1. The support equipment was authorized by Declaration of Confirmation.
2. For detachable type I/O cable should be specified the length in cm in 'Length' column
3. "YES" is means "shielded" "with core"; "NO" is means "unshielded" "without core".

4.4 Channel List

Channel List(802.11b/g/n20)					
Channel	Frequency (MHz)	Channel	Frequency (MHz)	Channel	Frequency (MHz)
01	2412	02	2417	03	2422
04	2427	05	2432	06	2437
07	2442	08	2447	09	2452
10	2457	11	2462	12	2467
13	2472				

4.5 Test Mode

Each of these EUT operation mode(s) or test configuration mode(s) mentioned above was evaluated respectively.

Pretest Mode	Description	
Mode1	CH01	802.11b
Mode2	CH07	
Mode3	CH13	
Mode4	RX	
Mode5	CH01	802.11g
Mode6	CH07	
Mode7	CH13	
Mode8	RX	
Mode9	CH01	802.11n20
Mode10	CH07	
Mode11	CH13	
Mode12	RX	

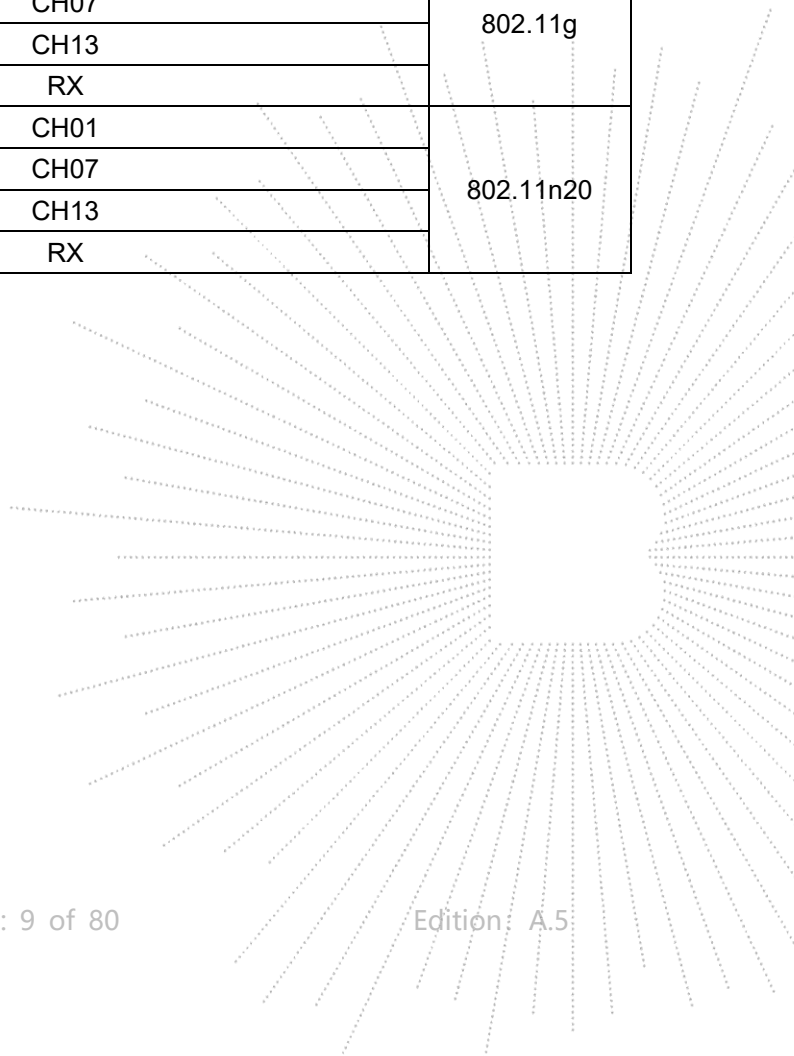

4.6 Test Conditions

The devices was tested while in a continuous transmitter/receiver mode. The EUT was tuned to a low, middle, and high channel for all tests. For all test case pre/scans were completed in all Modes to determine worst case levels.

Power Supply Voltage Fluctuation Test

Voltage Fluctuation Test	Normal Voltage	High Voltage +10% of Normal Voltage	Low Voltage -10% of Normal Voltage
Input DC Power	5V	5.5V	4.5V
Voltage Variation (%)	0%	+10%	-10%

Note:

Voltage Variation (%)= (Output high or Low Voltage - Output Normal Voltage)/ Output Normal Voltage* 100

During the input supply voltage to the EUT from the external power source is varied by +/-10%, +/-10% of the external power change, will not affect the voltage of the RF, so only operated in normal voltage to test all regulations.

4.7 Table Of Parameters Of Test Software Setting

During testing channel & power controlling software provided by the customer was used to control the operating channel as well as the output power level. The RF output power selection is for the setting of RF output power expected by the customer and is going to be fixed on the firmware of the final end product power parameters

Test software Version	SecureCRT		
Frequency	2412 MHz	2442 MHz	2472 MHz
Parameters	DEF	DEF	DEF

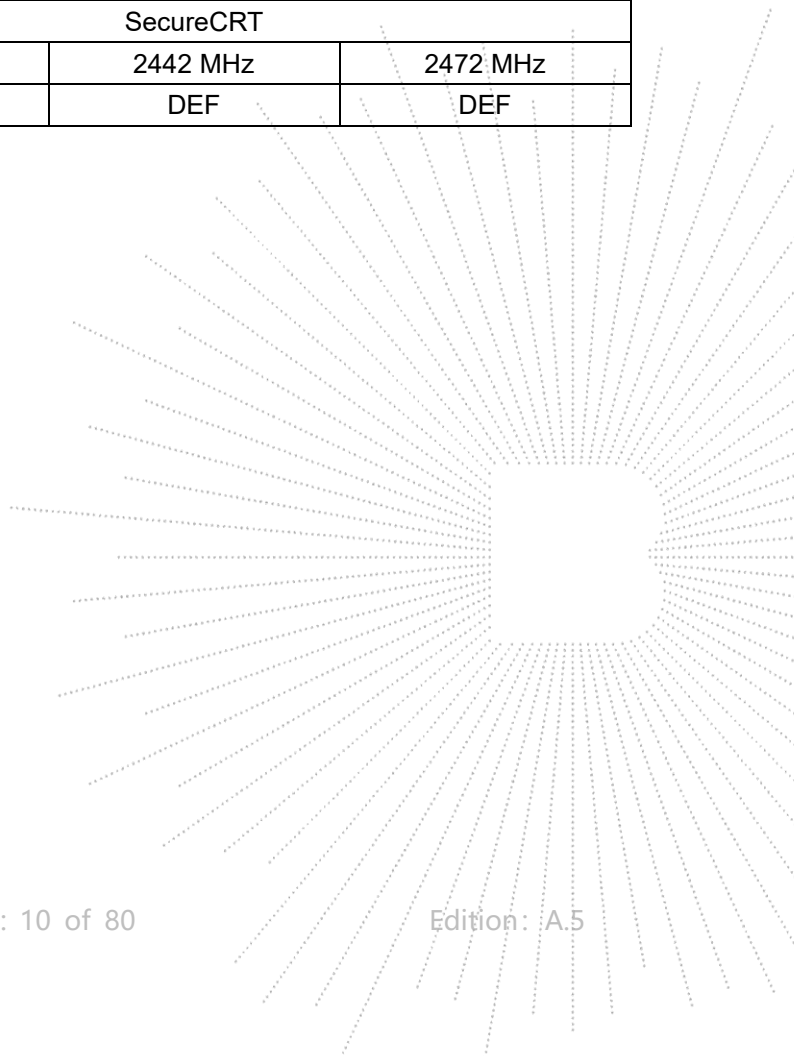

5. Test Facility And Test Instrument Used

5.1 Test Facility

All measurement facilities used to collect the measurement data are located at Shenzhen BCTC Testing Co., Ltd. Address:1-2/F., Building B, Pengzhou Industrial Park, No.158, Fuyuan 1st Road, Zhancheng, Fuhai Subdistrict, Bao'an District, Shenzhen, Guangdong, China. The site and apparatus are constructed in conformance with the requirements of ANSI C63.4 and CISPR 16-1-1 other equivalent standards.

FCC Test Firm Registration Number: 712850

IC Registered No.: 23583

5.2 Test Instrument Used

Item	Equipment	Manufacturer	Type No.	Serial No.	Last calibration	Calibrated until
1	Power meter	Keysight	E4419	\	May 26, 2022	May 25, 2023
2	Signal Analyzer20kHz-26.5GHz	Keysight	N9020A	MY49100060	May 26, 2022	May 25, 2023
3	D.C. Power Supply	LongWei	TPR-6405D	\	\	\
4.	Signal Generator	Keysight	N5182B	MY56200519	May 24, 2022	May 23, 2023
5.	Attenuator	\	10dB DC-6GHz	1650	May 24, 2022	May 23, 2023

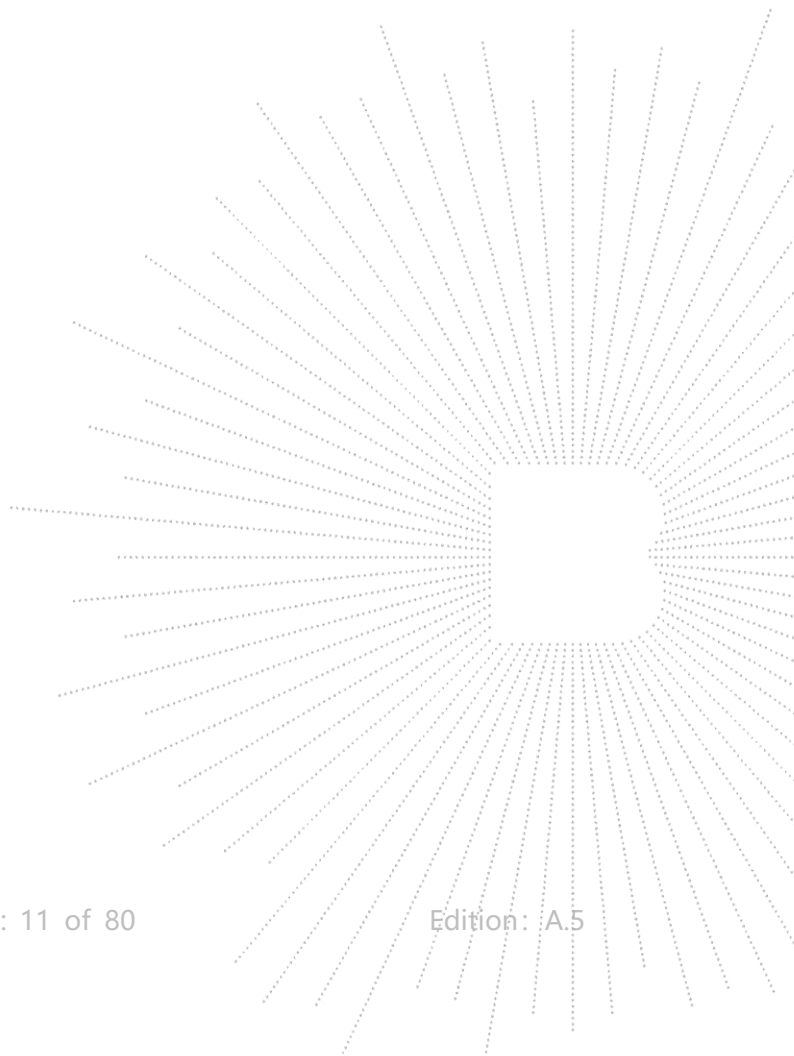

6. RF Shielding Method

Enclosure:

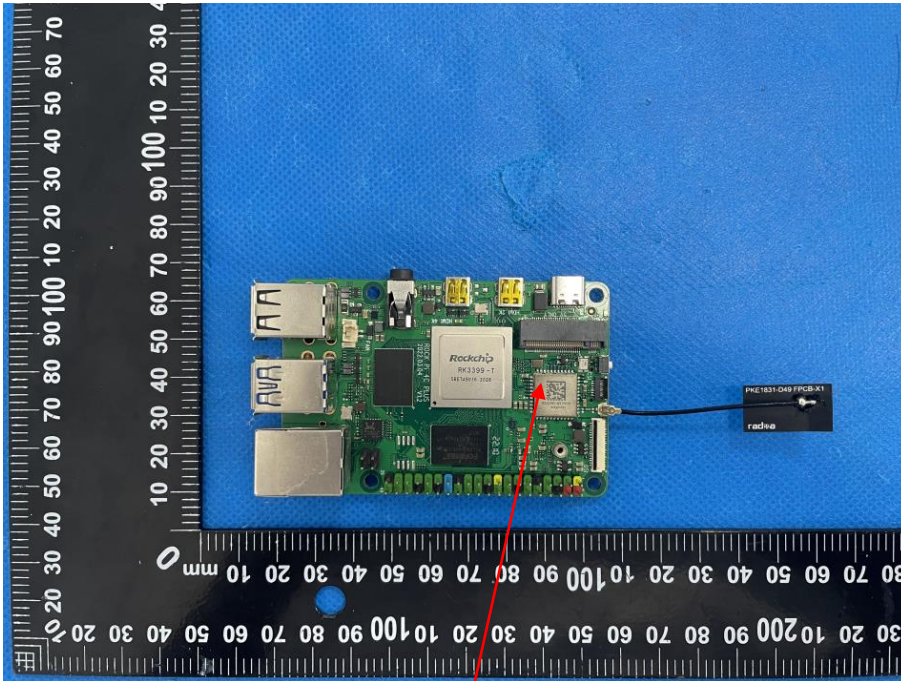

Built-in shielding cover

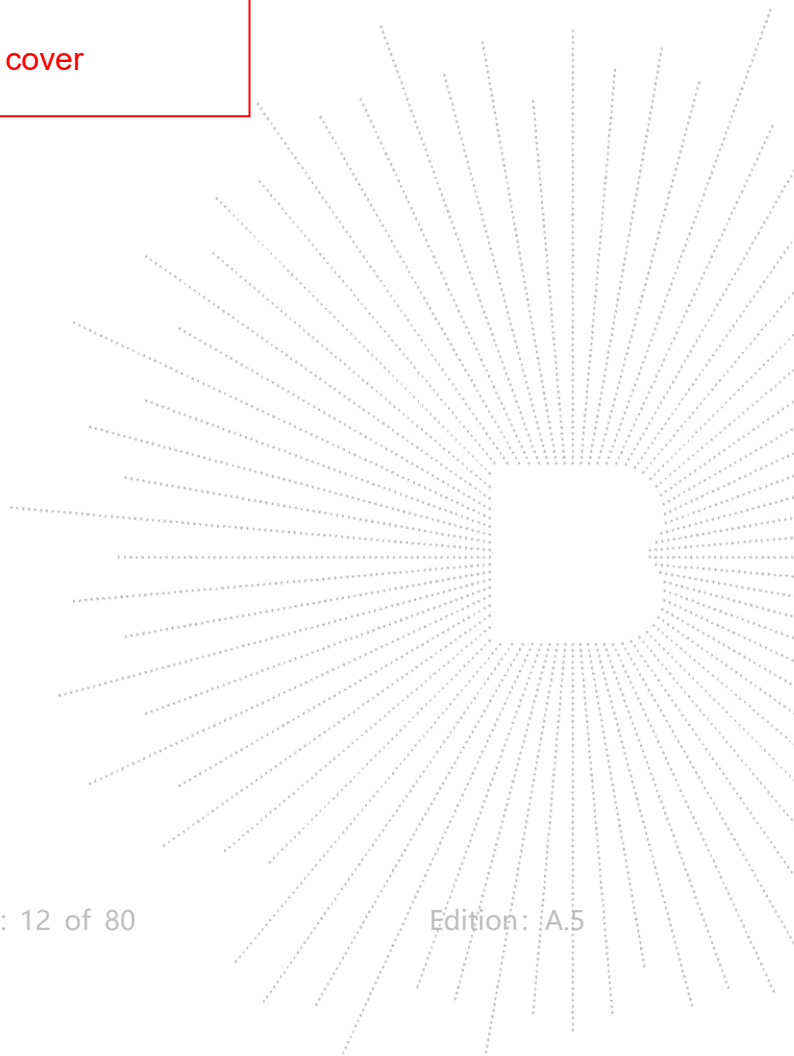

7. Frequency Error

7.1 Block Diagram Of Test Setup

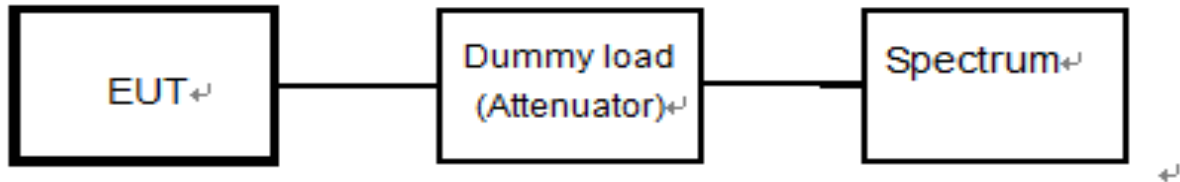

7.2 Limit

Item	Limits
Frequency Error	±50ppm

7.3 Measuring Instruments And Setting

The following table is the setting of Spectrum Analyzer.

Spectrum Parameter	Setting
Attenuation	Auto
RB / VB	10KHz
Detector	Peak
Trace	Max Hold
Sweep Time	Auto

7.4 Test Procedure

- (1) In the case of unmodulated signal (continuous or continuous burst), measure the frequency directly by a frequency meter.
- (2) In the case of burst waves, the measurement shall be done for enough time in order to obtain the enough measuring accuracy, and the average of the measured values becomes the final value.
- (3) In the case of a test mode with a specific frequency spectrum, measure the frequency of the specific spectrum by a spectrum analyzer.
- (4) In the cases above, if the frequency equivalent to the test frequency is not directly measured in principle, it shall be obtained by necessary calculation.
 In the case of modulated signal, if there is no specific spectrum measurable by a spectrum analyzer but a specific dip is observed, it is allowed to measure the frequency with the signal generator (synthesized). That is, observe a signal of the signal generator concurrently (or alternately) with the tested signal using the spectrum analyzer while setting the frequency of the signal generator to the position of the dip on the screen of the spectrum analyzer, and determine the frequency of the signal generator at the time as a measured value.

7.5 Test Result

Operation Mode:	Transmitting- unmodulation mode
-----------------	---------------------------------

Test Voltage	Test Frequency (MHz)	Measured Frequency (MHz)	Frequency Error(ppm)	Limit (ppm)	P/F
Normal Voltage	2412	2411.949	-21.14	±50	PASS
	2442	2441.948	-21.29	±50	PASS
	2472	2471.948	-21.04	±50	PASS

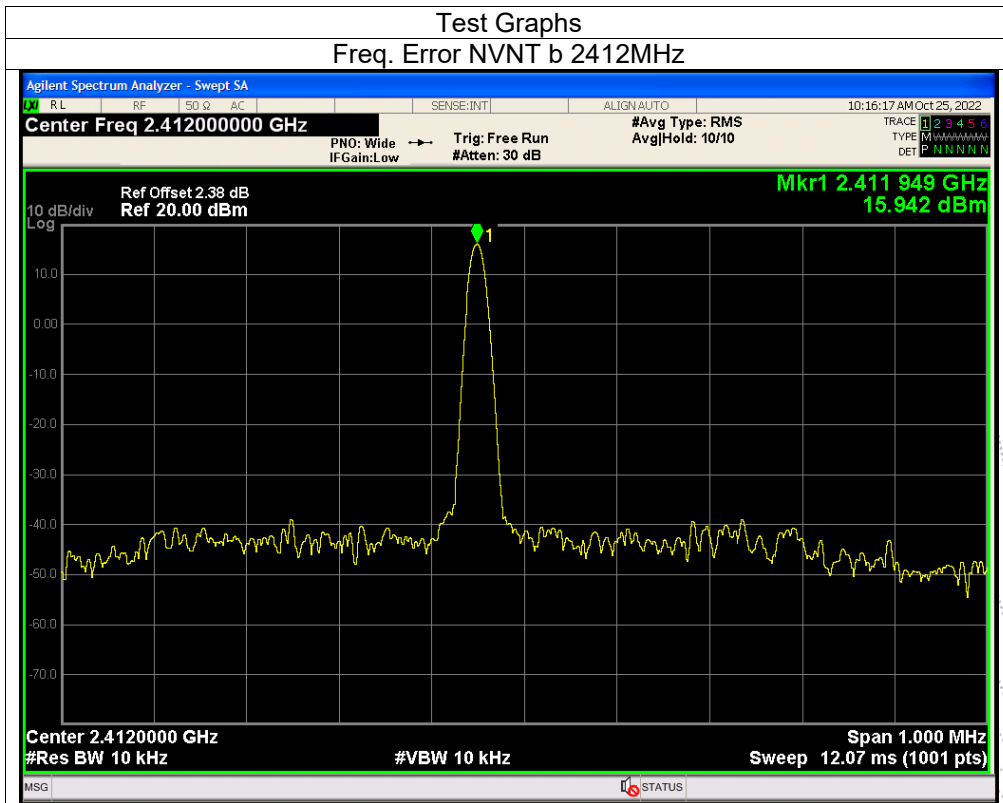

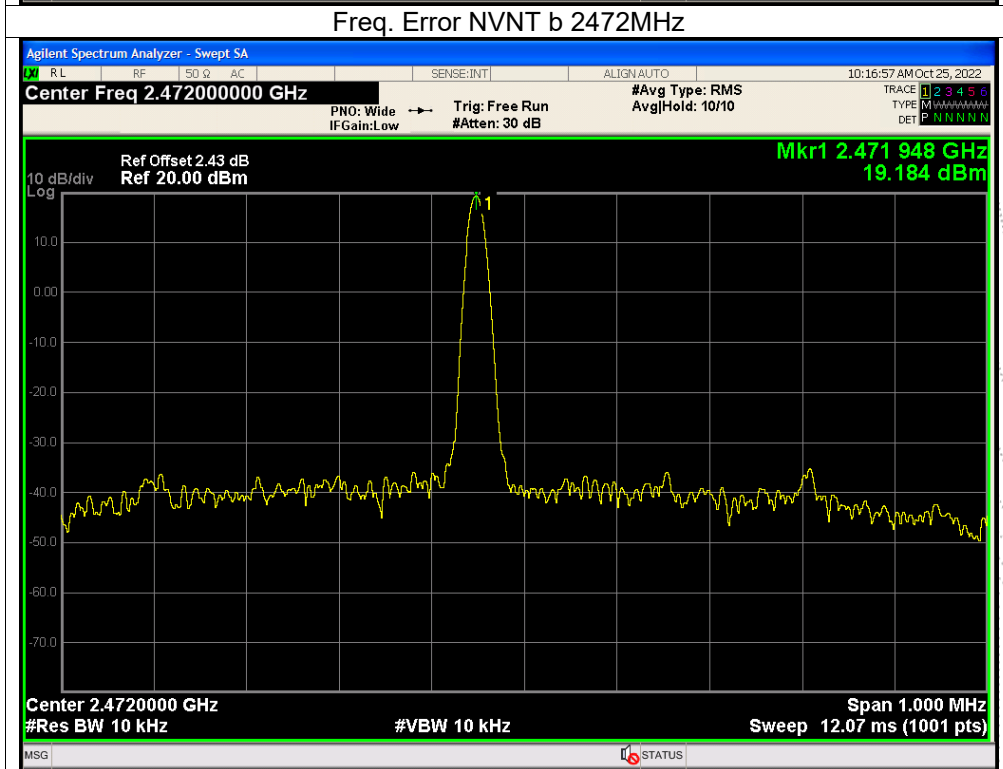
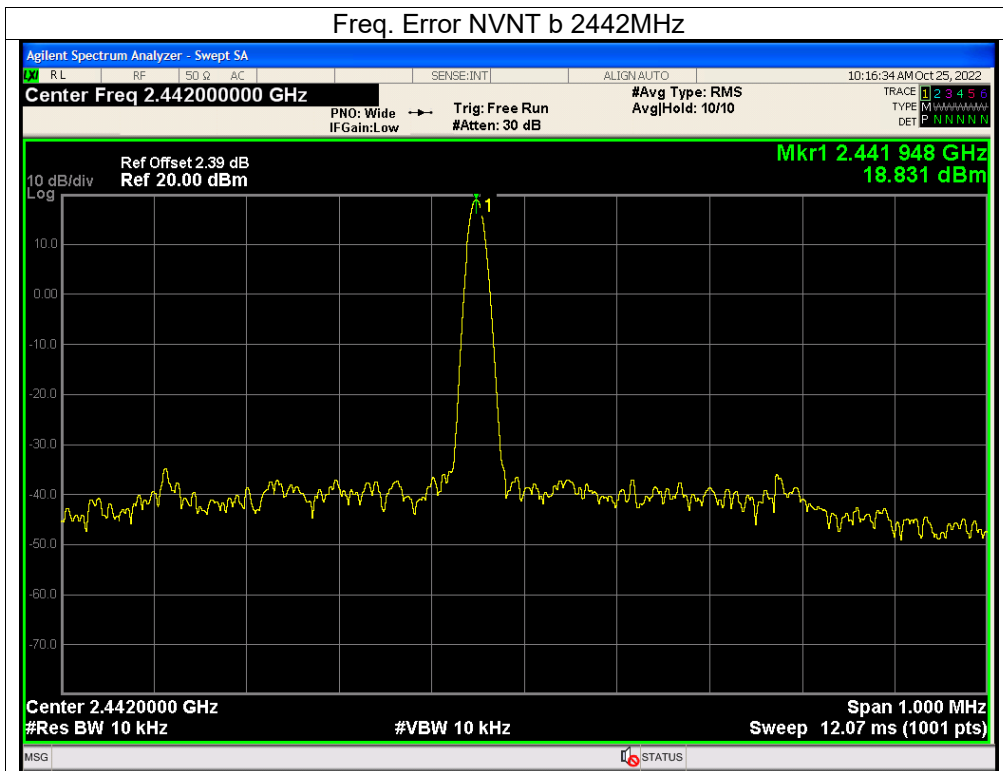

8. Antenna Power

8.1 Block Diagram Of Test Setup

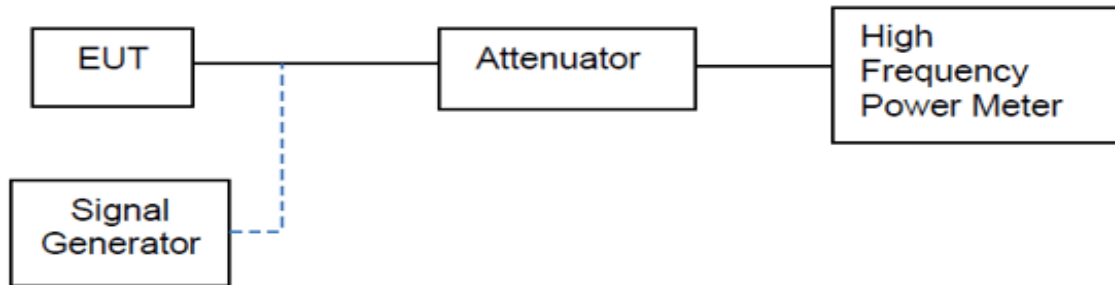

8.2 Limit

Item	Limits
Antenna Power Density	(1) $\leq 3\text{mW/MHz}$ (FH, FH+DS, FH+OFDM form 2400 - 2483.5 MHz) (2) $\leq 10\text{mW/MHz}$ (OFDM OBW < 26MHz, DS, FH other than (1)) (3) $\leq 5\text{mW}$ (OFDM OBW 26-38MHz) (4) $\leq 10\text{mW}$ (Other than (1) & (2)& (3))
Antenna Power Error	+20%, -80% (Base on manufacturer declare antenna power density)

8.3 Test Procedure

Step 1: Connect the EUT to the Spectrum analyser and use the following settings:

Centre Frequency: The Centre frequency of the channel under test.

RBW: 1 MHz.

VBW: 1 MHz.

Span: Wide enough to cover the complete power envelope of the signal of the EUT.

Detector: Peak.

Trace Mode: Max Hold.

Step 2: When the trace is complete, find the peak value of the power envelope and record the frequency.

Step 3: Make the following changes to the settings of the Spectrum analyser:

Centre Frequency: Equal to the frequency recorded in step 2.

Span: 0 MHz.

RBW: 1 MHz.

VBW: 1 MHz.

Detector: Peak

Trace Mode: Max Hold

8.4 Test Result

Test voltage (V)	Mode	Channel (MHz)	Antenna Power (dBm/MHz)	Antenna Power (mW/MHz)	Rated output power (mW/MHz)	Tolerance (%)	Limit
Normal Voltage DC 5V	802.11b	2412	4.622	2.899	3	-3	10mW/MHz -80%~+20%
		2442	4.494	2.814	3	-6	
		2472	4.114	2.579	3	-14	
	802.11g	2412	3.181	2.080	3	-31	
		2442	3.973	2.496	3	-17	
		2472	2.684	1.855	3	-38	
	802.11n (HT20)	2412	2.502	1.779	2	-11	
		2442	2.676	1.852	2	-7	
		2472	1.528	1.422	2	-29	

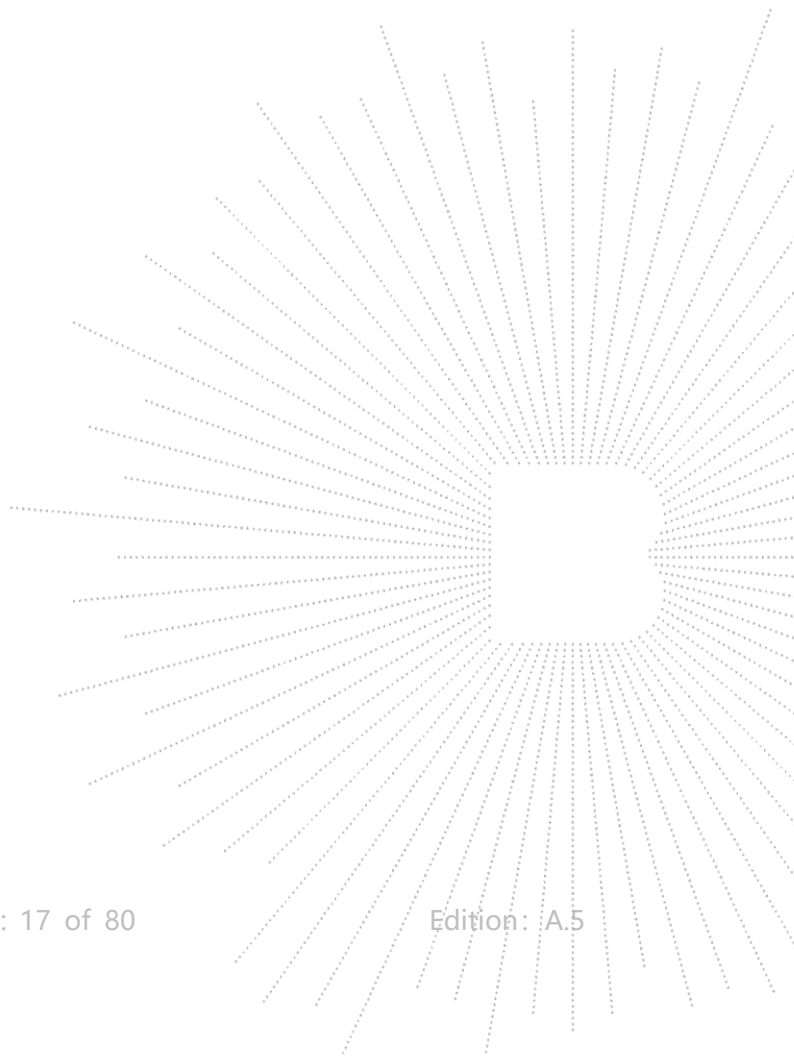

Normal Voltage

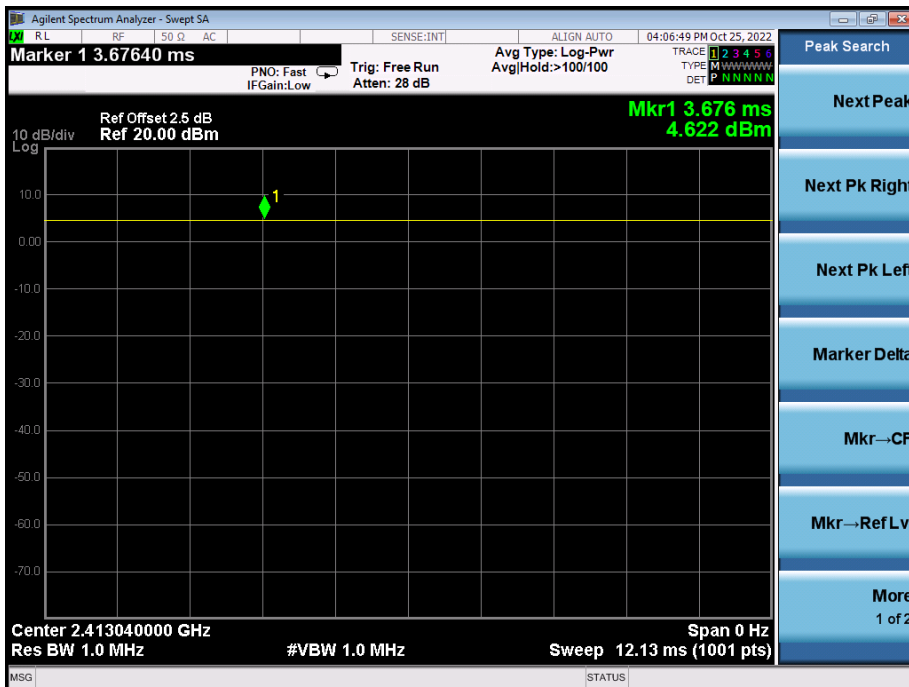
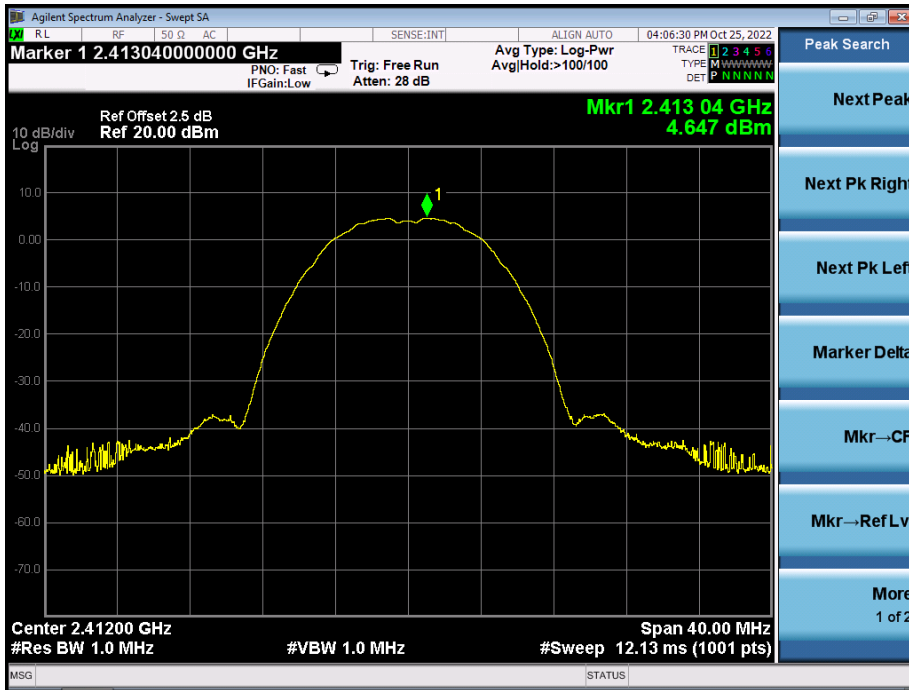
 802.11b
 CH01

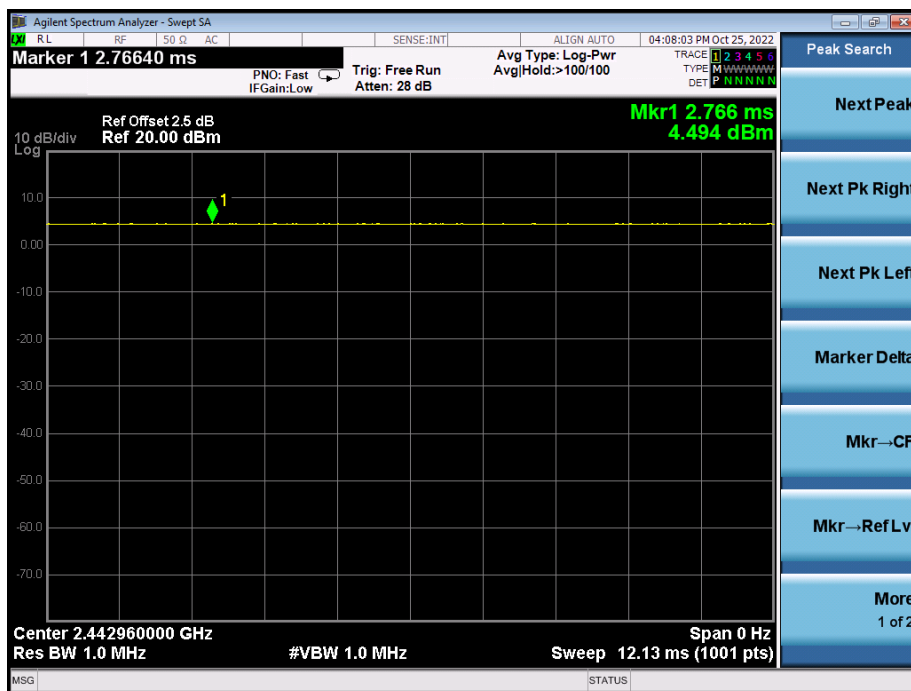
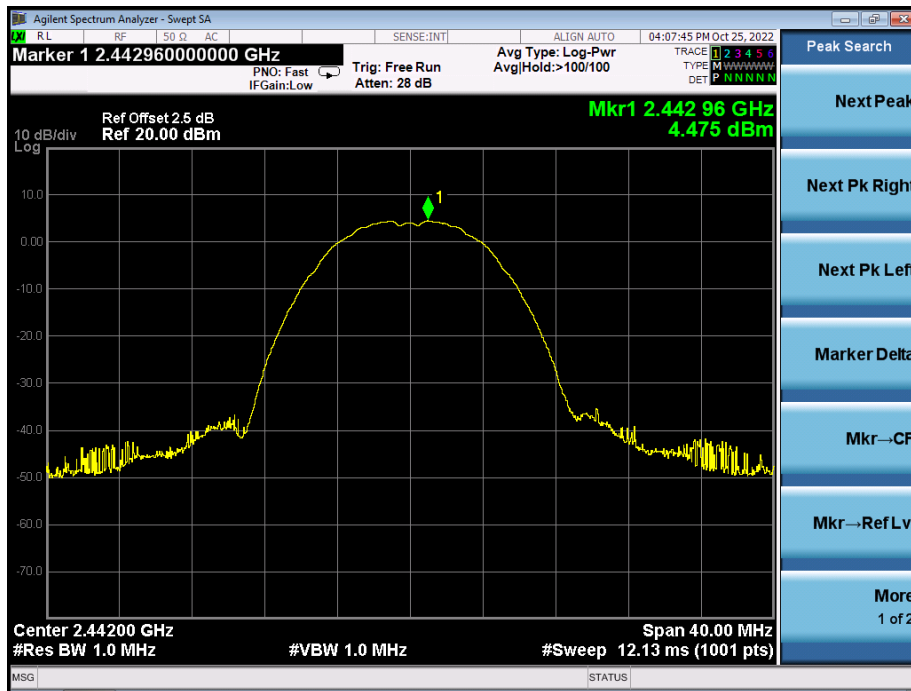
CH07

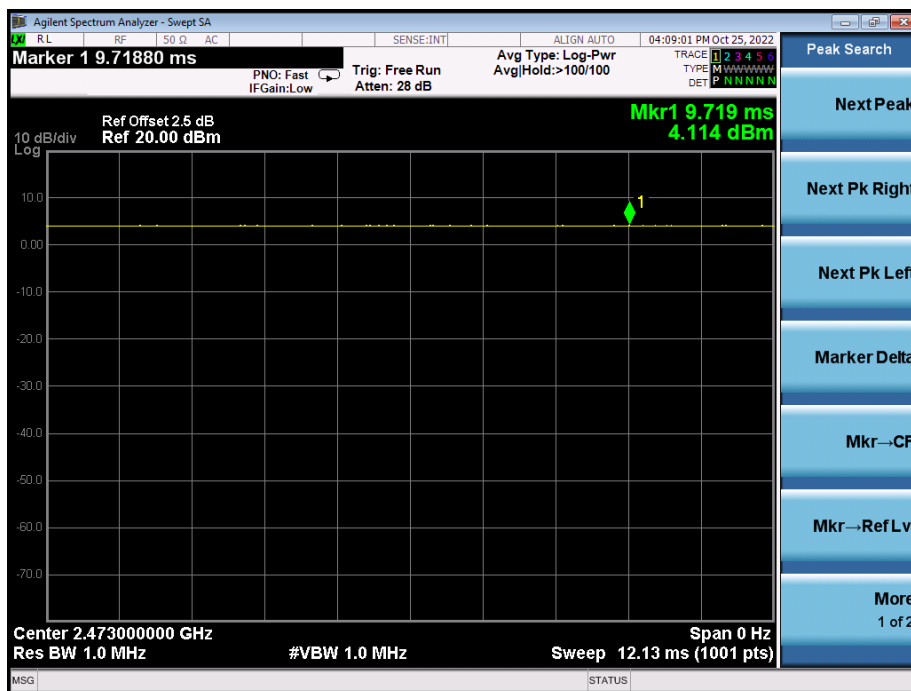
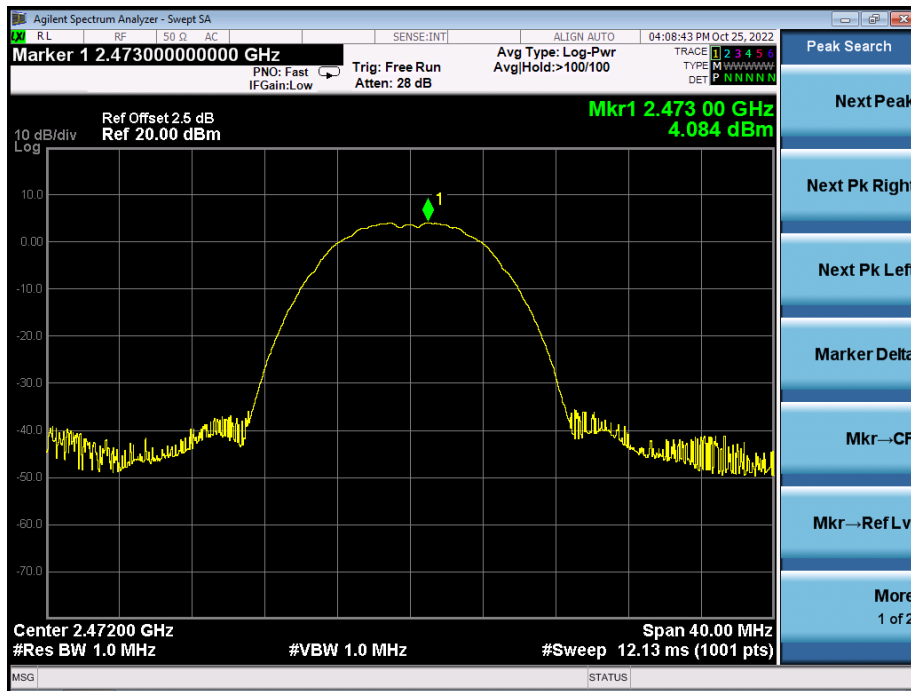
CH13

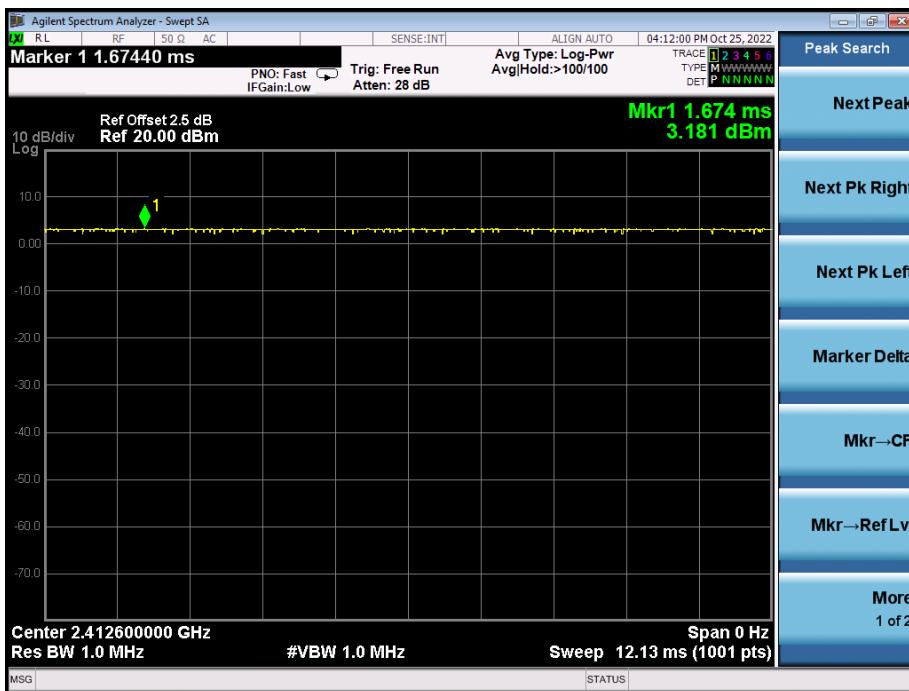
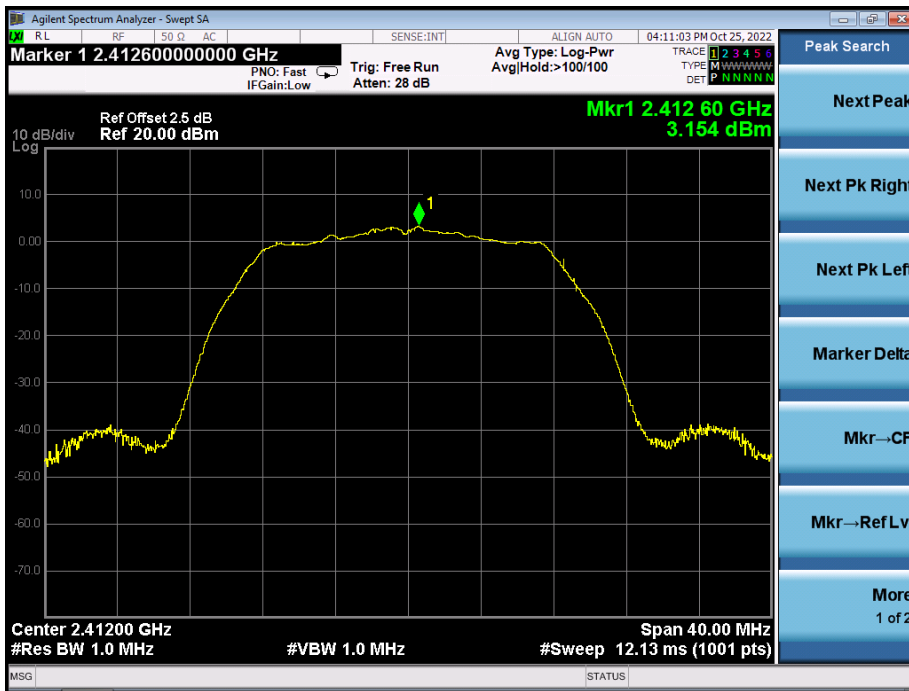
802.11g
 CH01

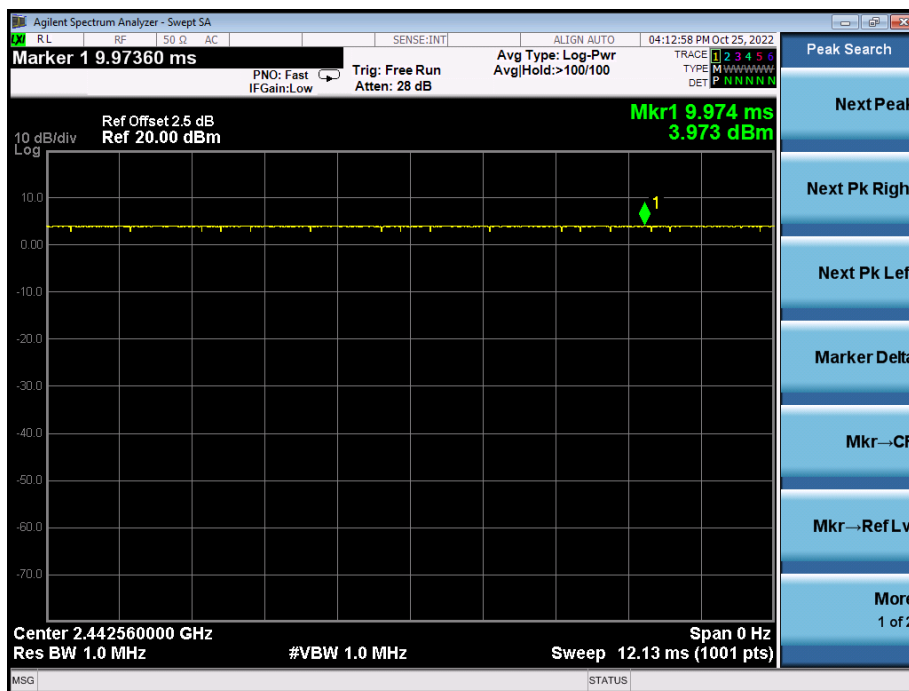
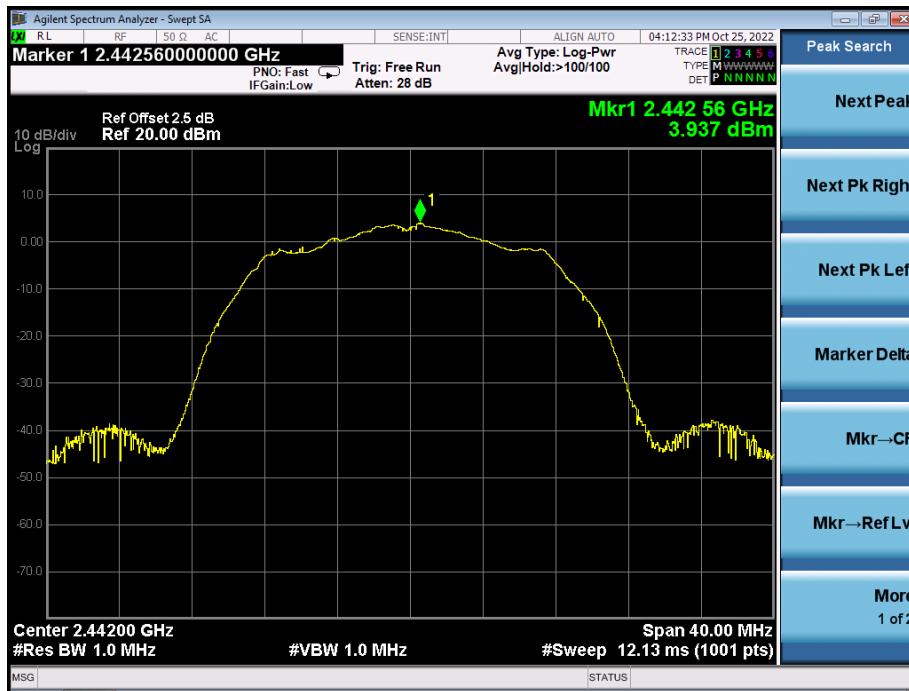
CH07

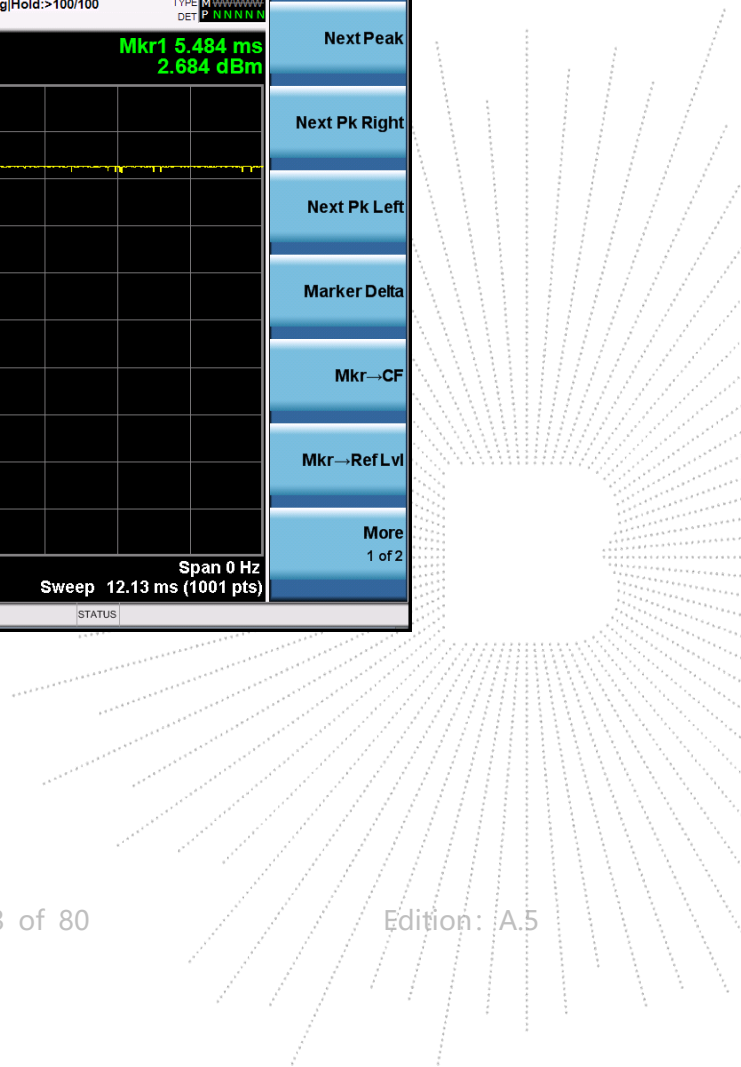
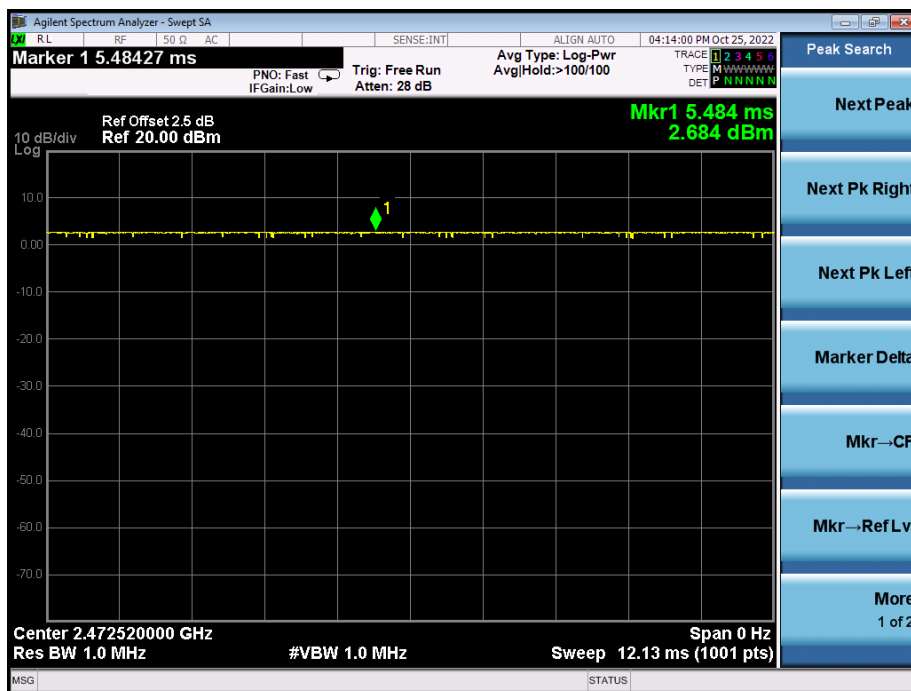
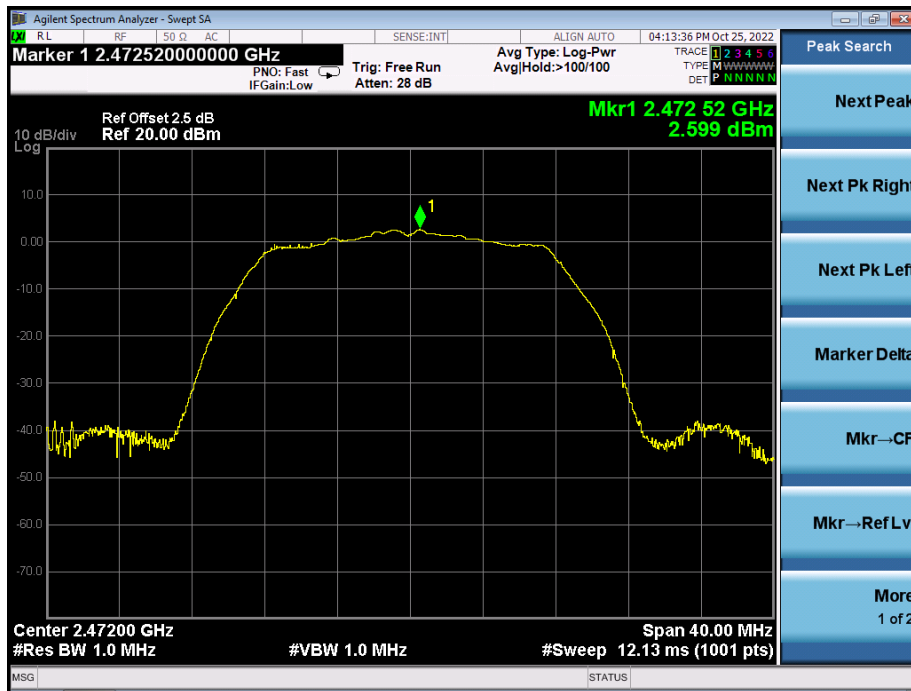
CH13

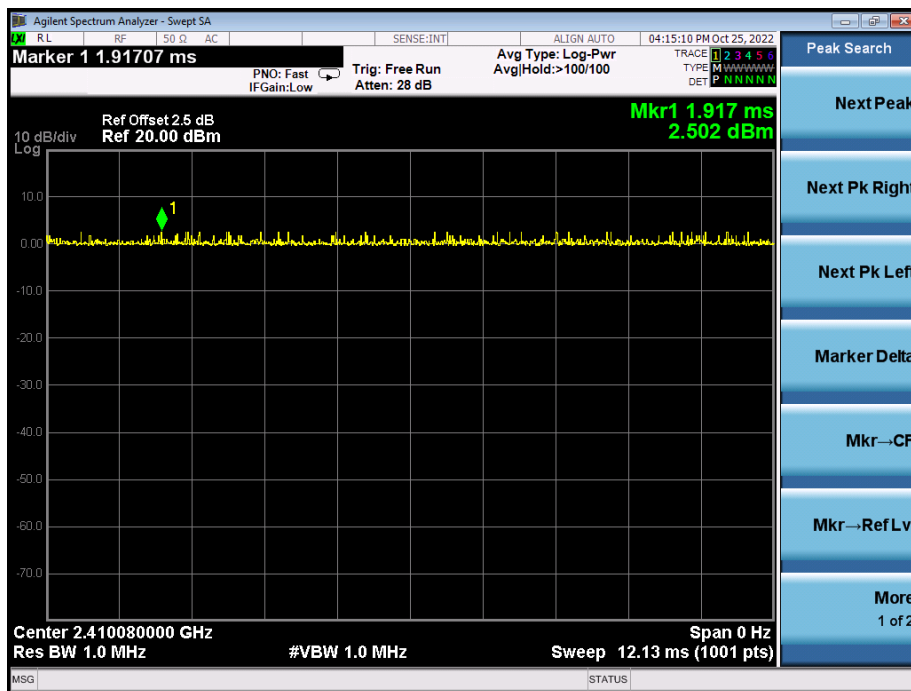
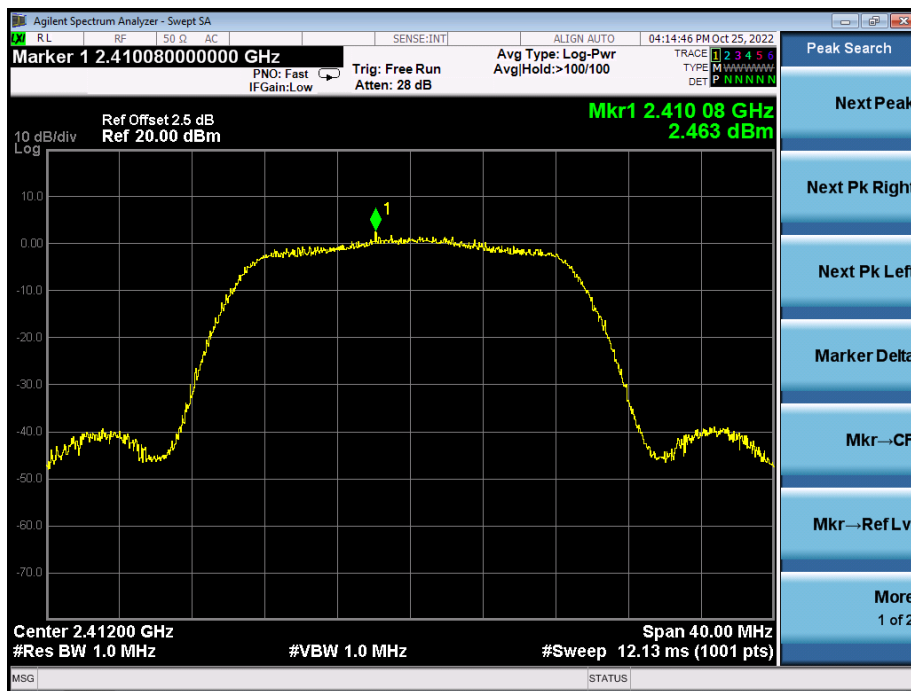
802.11n20
 CH01

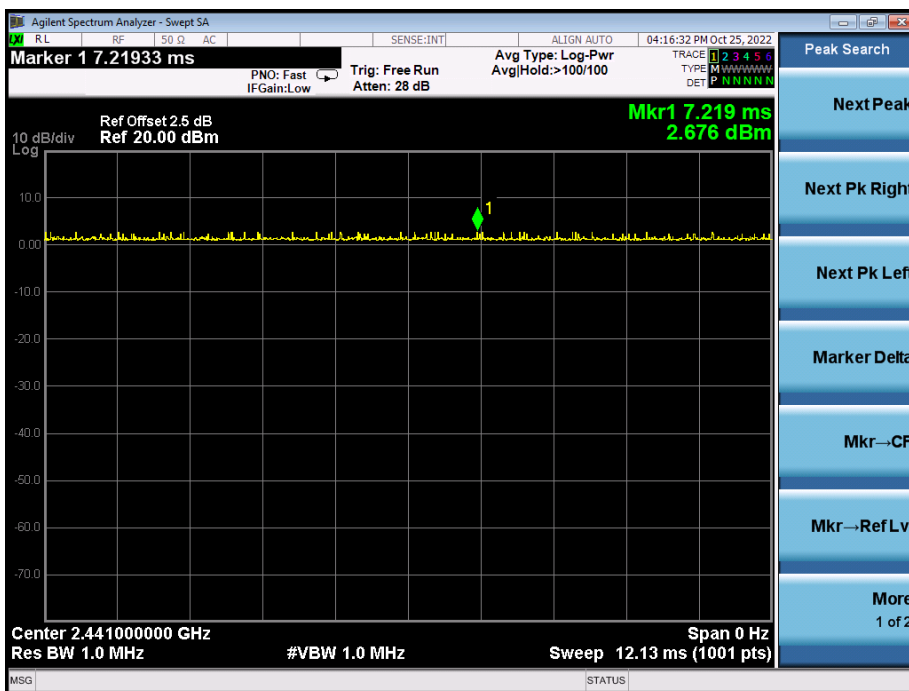
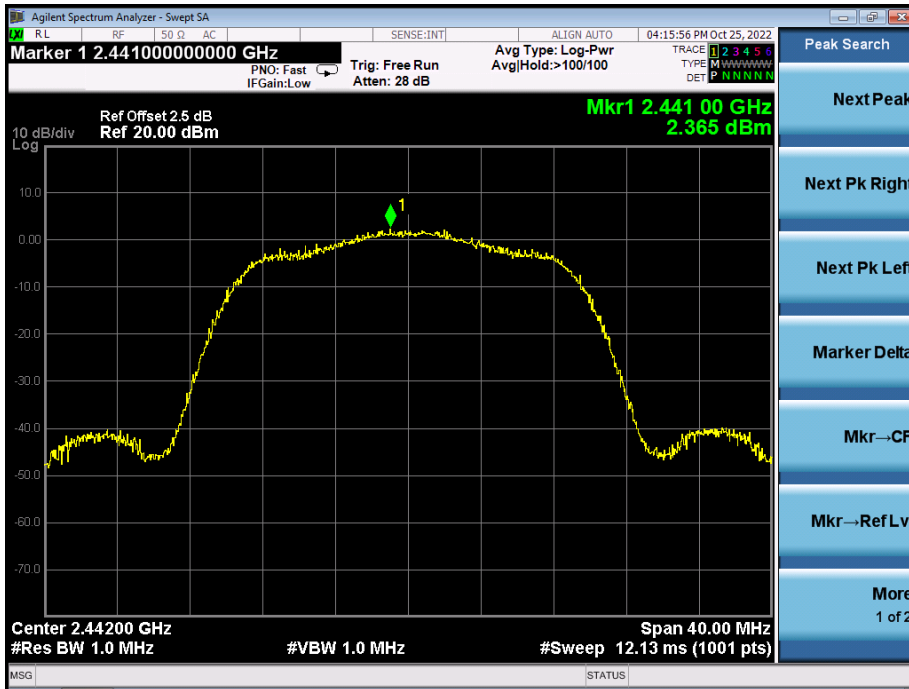
CH07

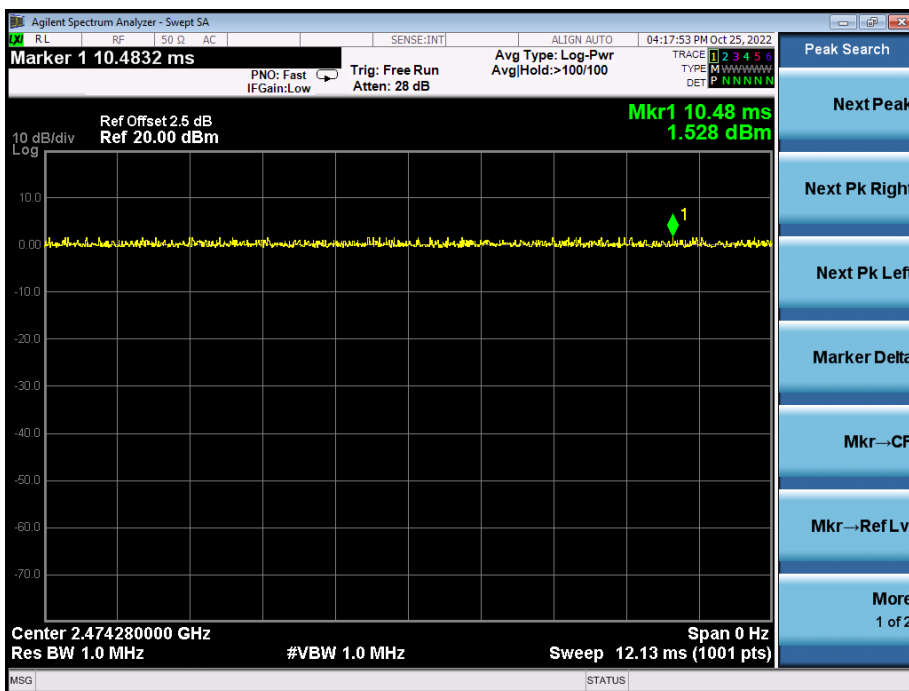
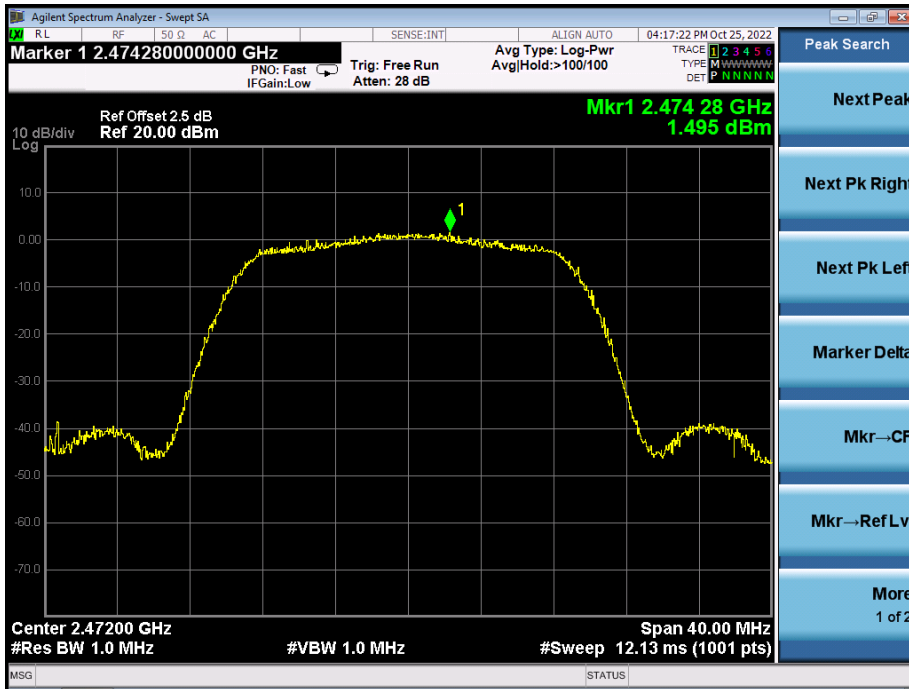
CH13

9. Occupied Bandwidth And Spread-Spectrum Bandwidth Measurement

9.1 Block Diagram Of Test Setup

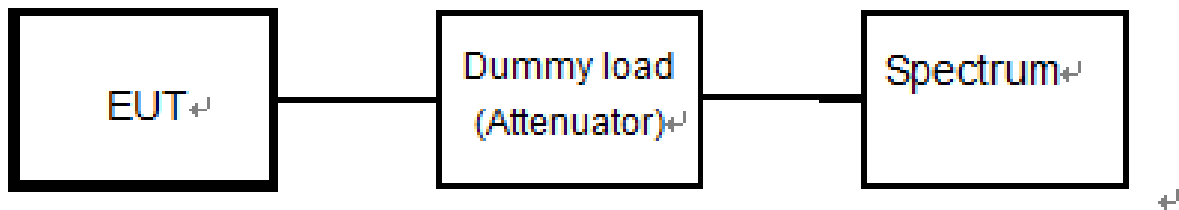

9.2 Limit

Item	Limits
Occupied Band Width:	802.11b,g,n(HT20): 26MHz or less 802.11n(HT40): 38 MHz or less
Spreading Bandwidth:	≥ 500 kHz (FH, DS)

9.3 Test Procedure

1. Setting of SA is following as: RB: 300kHz / VB:300kHz / SPAN: 3MHz / AT: 20dB Ref: 10dBm / Sweep time: Auto / Sweep Mode: Continuous sweep / Detect mode: Positive peak / Trace mode: Max hold
2. EUT have transmitted the maximum modulation signal and fixed channelize (For DSSS or OFDM Device) or continuous maximum power of hopping mode(For FHSS Device). SA set to 99% of occupied bandwidth to measure occupied bandwidth. The limit is less than 26MHz (For DSSS or OFDM Device) or 83.5MHz (For FHSS Device).
3. SA set to 90% of occupied bandwidth to measure Spread Spectrum Bandwidth and must greater than 500kHz.
4. Spread Spectrum Factor = Spread Spectrum Bandwidth / modulation rate of EUT.
5. Spread Spectrum Factor limit is greater than 5

9.4 Test Result

Operation Mode	Voltage	Test Frequency (MHz)	99% Occupied Bandwidth (MHz)	90% Occupied Bandwidth (MHz)	Spread Factor
Normal Voltage	b mode	2412	14.214	9.188	6.682
		2442	14.192	9.180	6.676
		2472	14.173	9.170	6.669
	g mode	2412	16.602	13.811	/
		2442	16.573	13.787	/
		2472	16.573	13.782	/
	n20 mode	2412	17.551	14.738	/
		2442	17.555	14.748	/
		2472	17.568	14.723	/

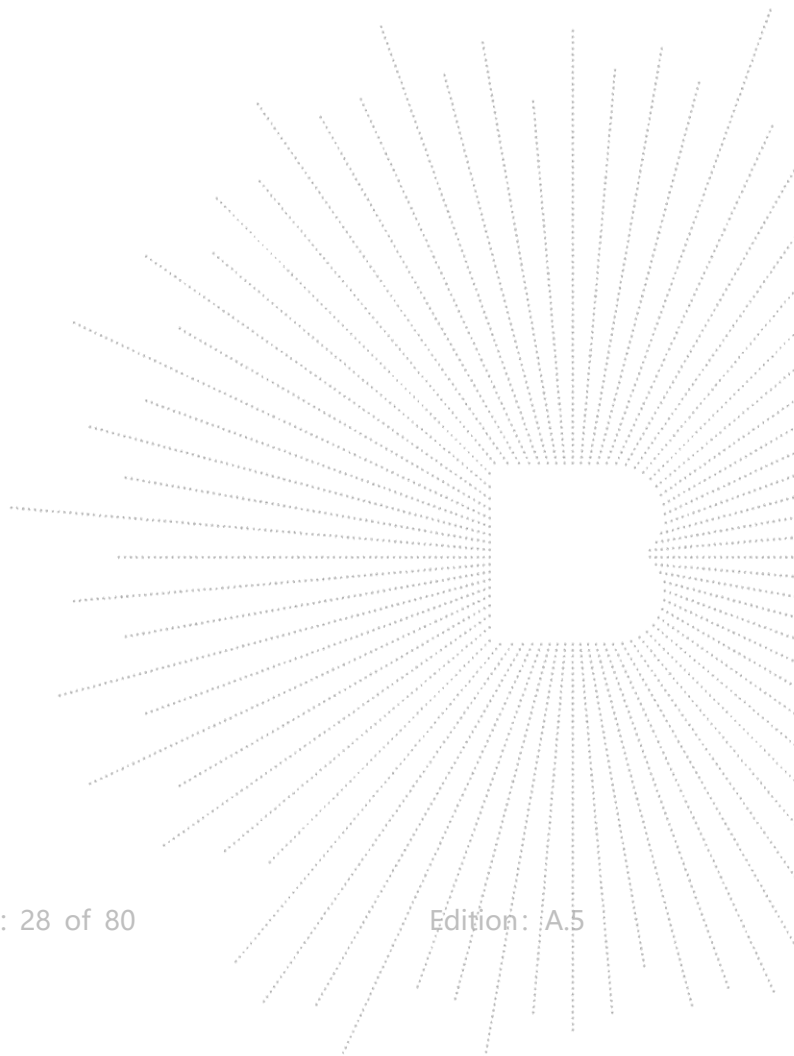

CH1-Occupied Bandwidth (99%)-B Mode

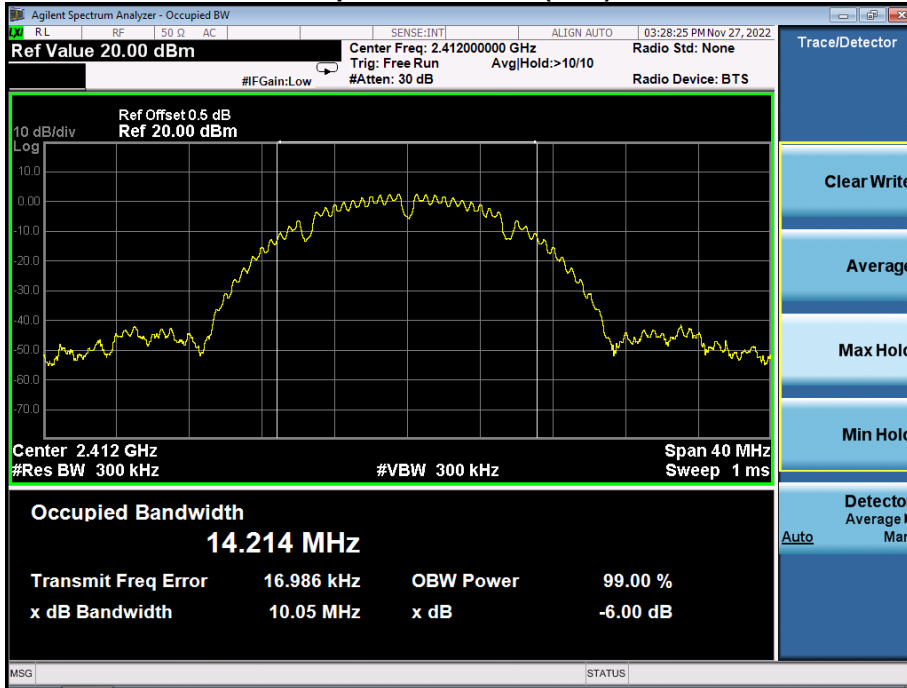

CH1-Spread Bandwidth (90%)-B Mode

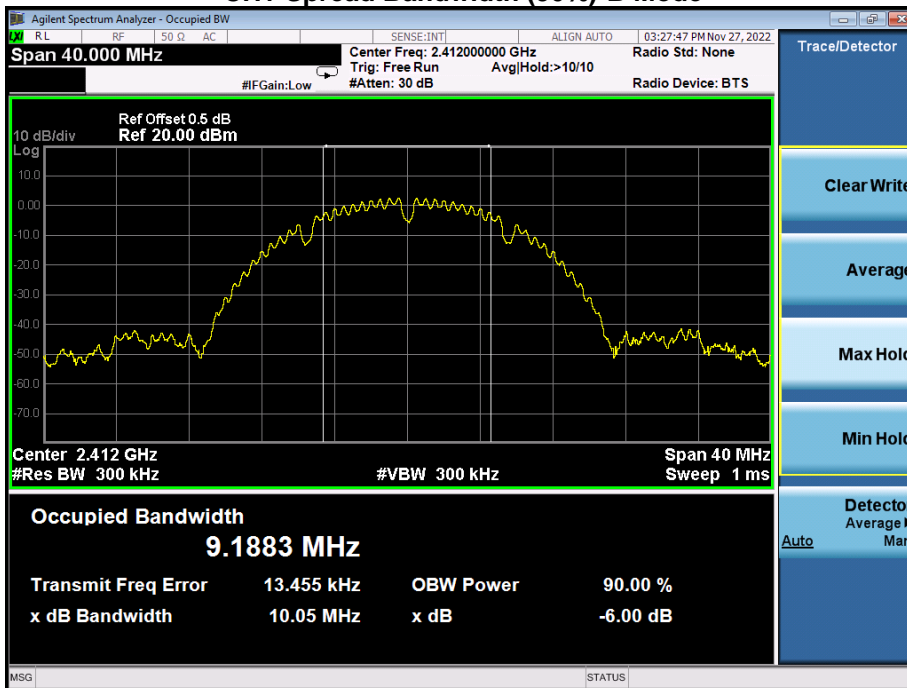

CH7-Occupied Bandwidth (99%)-B Mode

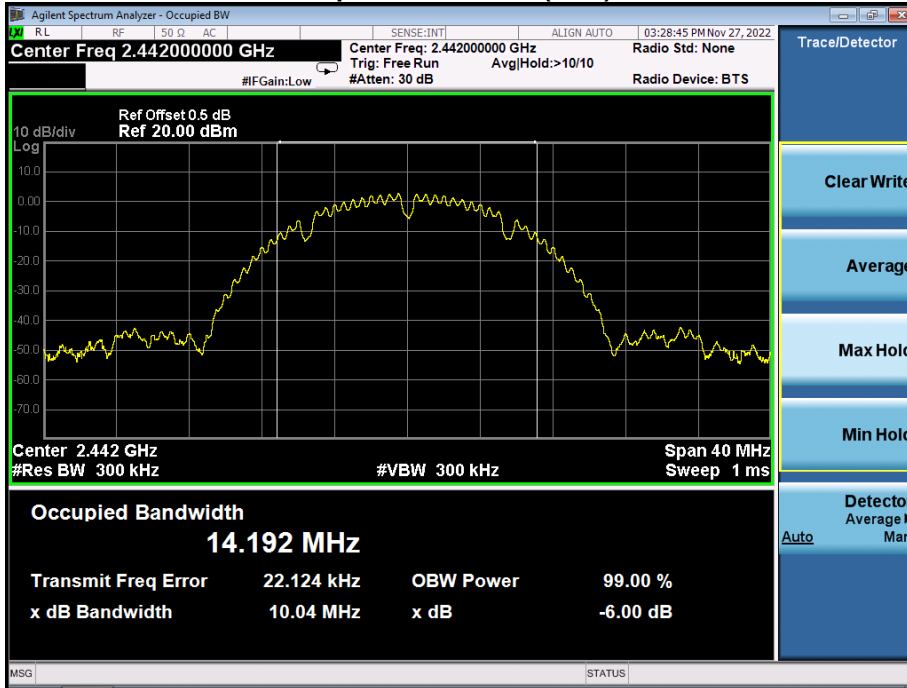

CH7-Spread Bandwidth (90%)-B Mode

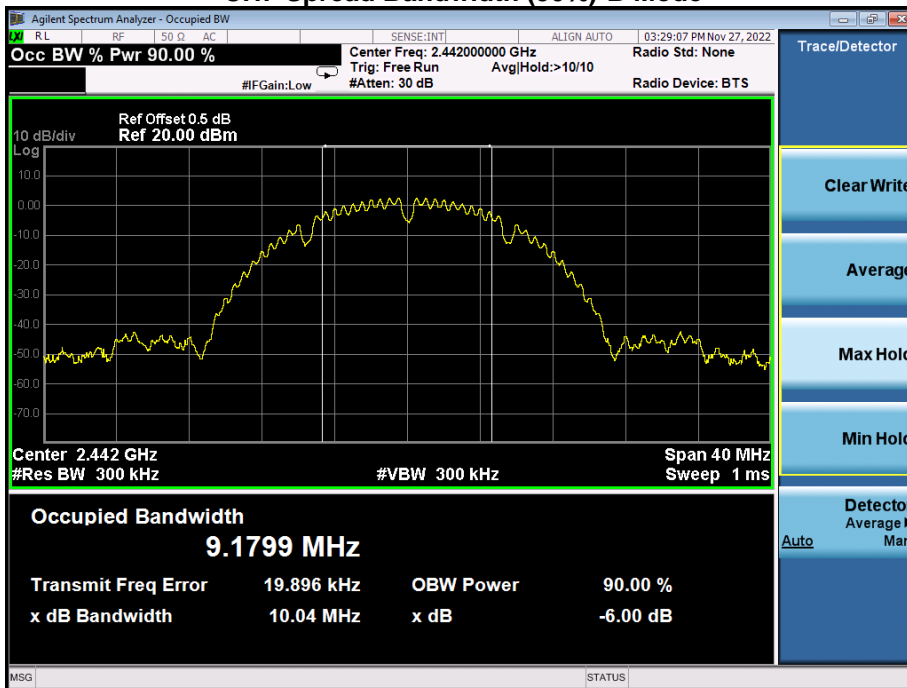

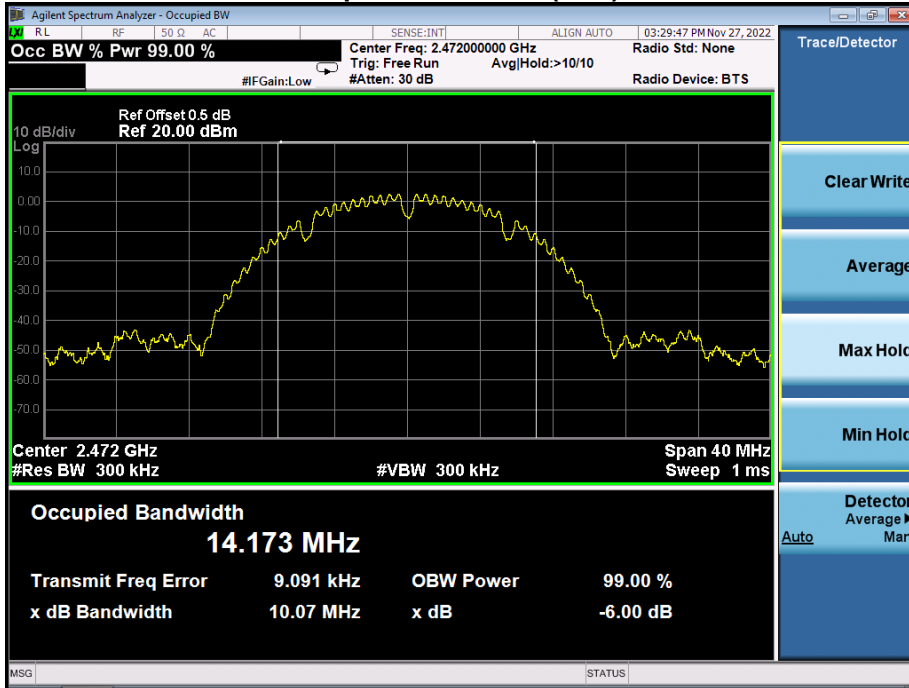
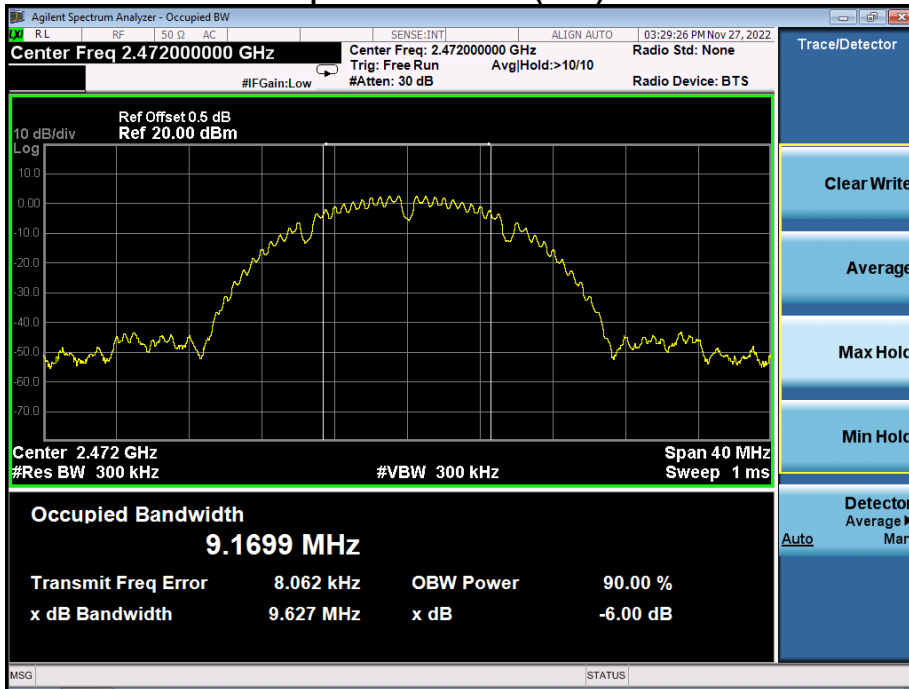
CH13-Occupied Bandwidth (99%)-B Mode

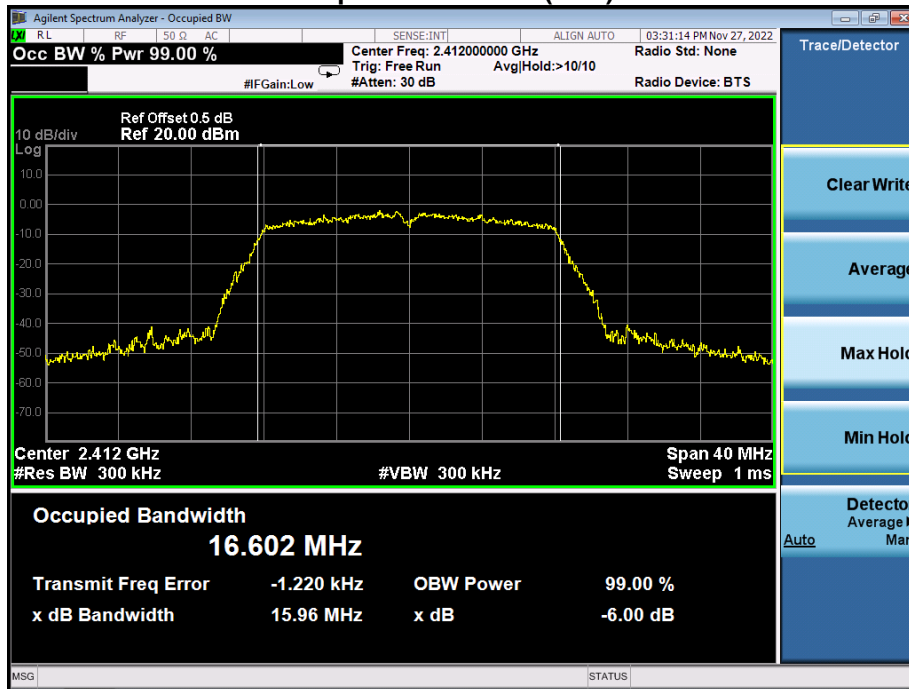
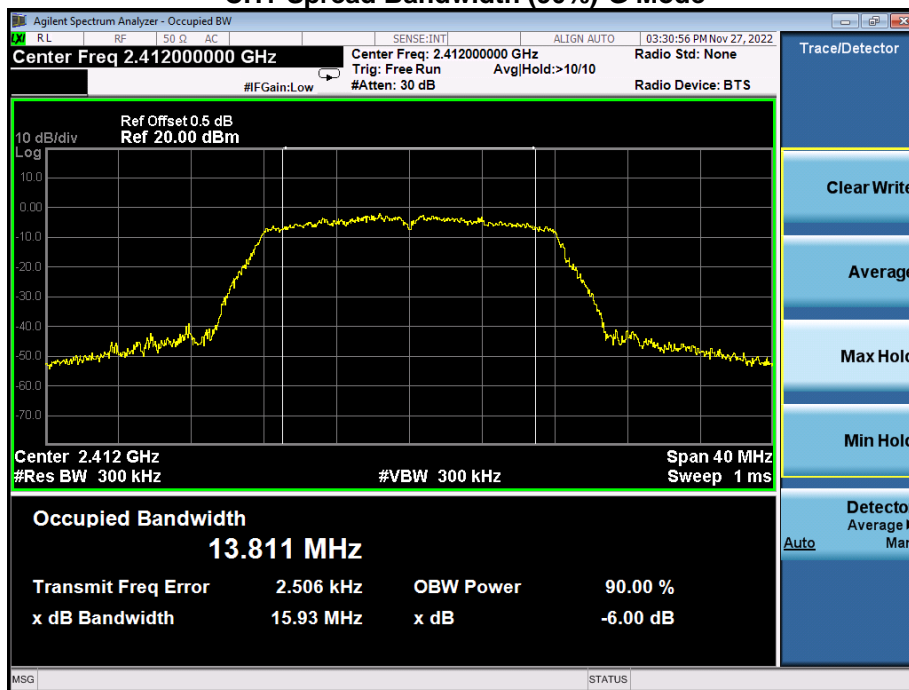
CH13-Spread Bandwidth (90%)-B Mode

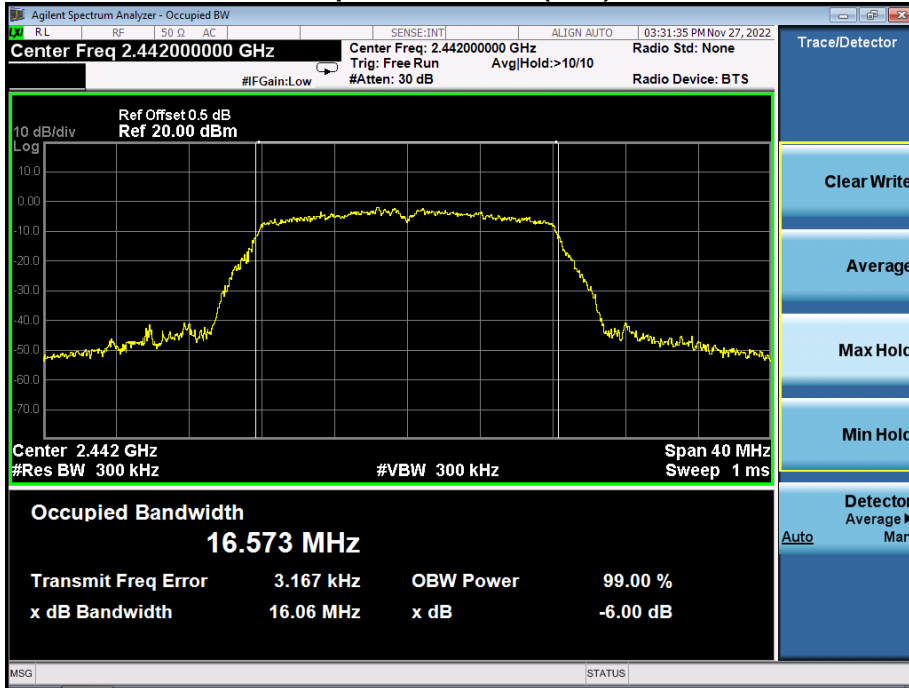
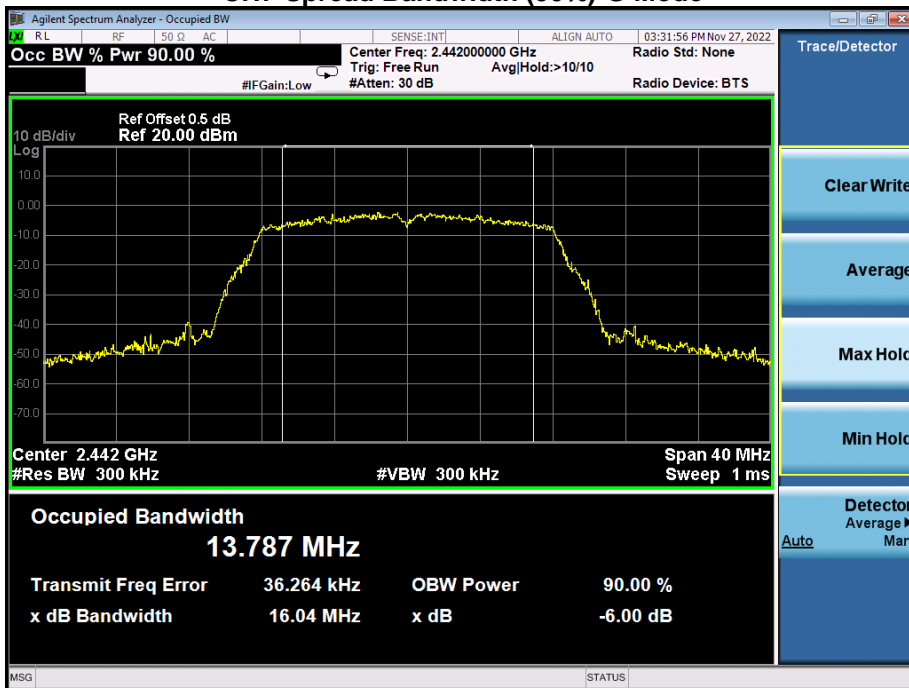
CH1-Occupied Bandwidth (99%)-G Mode

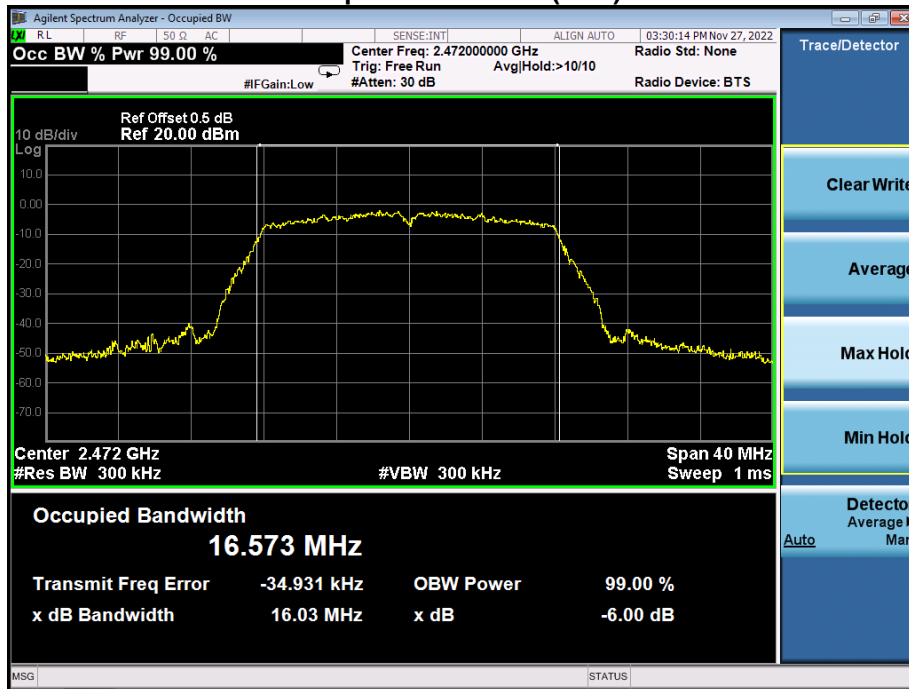
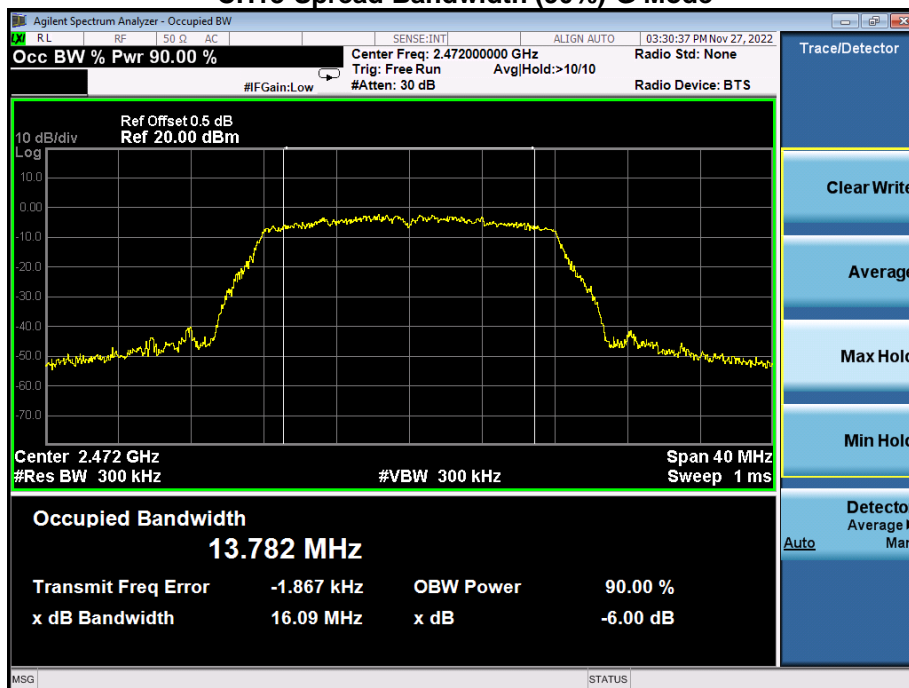
CH1-Spread Bandwidth (90%)-G Mode

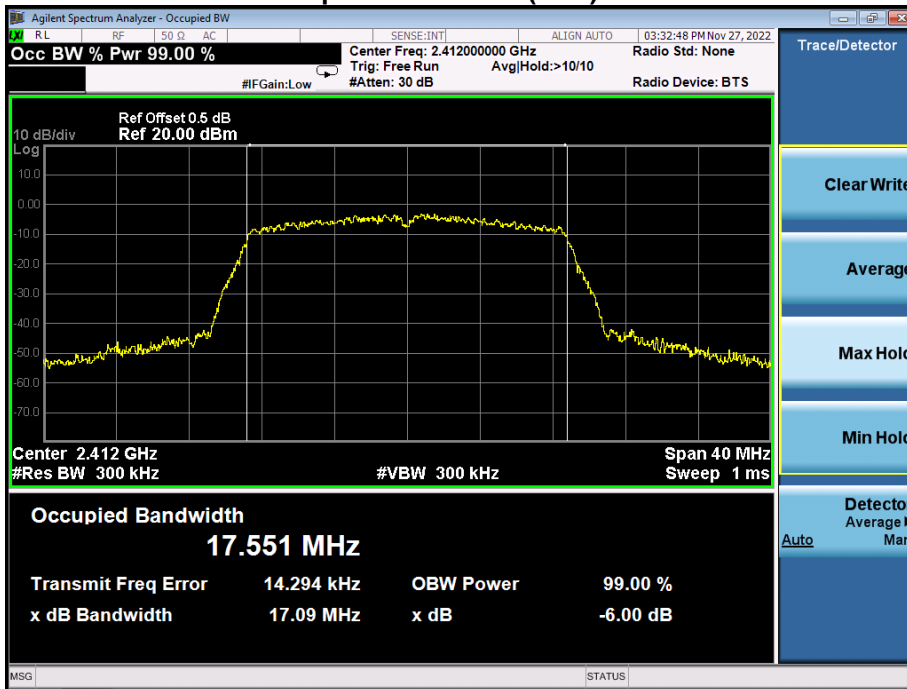
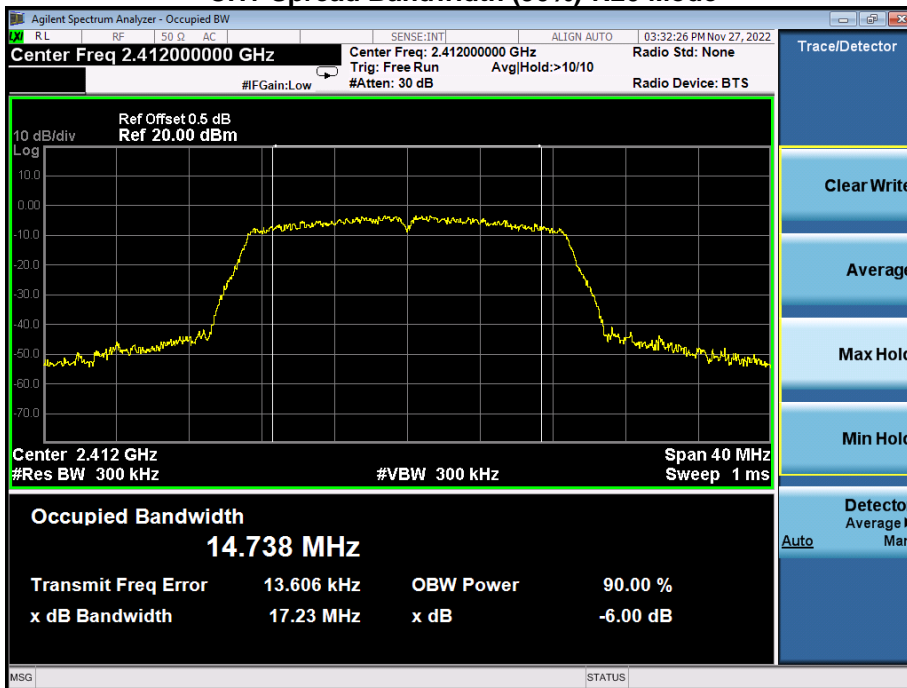
CH7-Occupied Bandwidth (99%)-G Mode

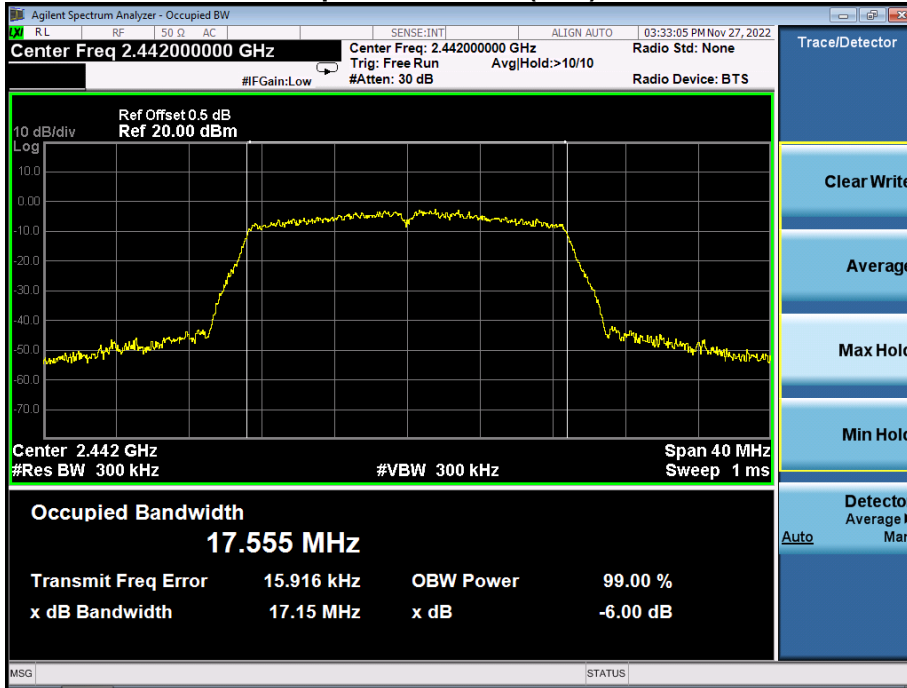
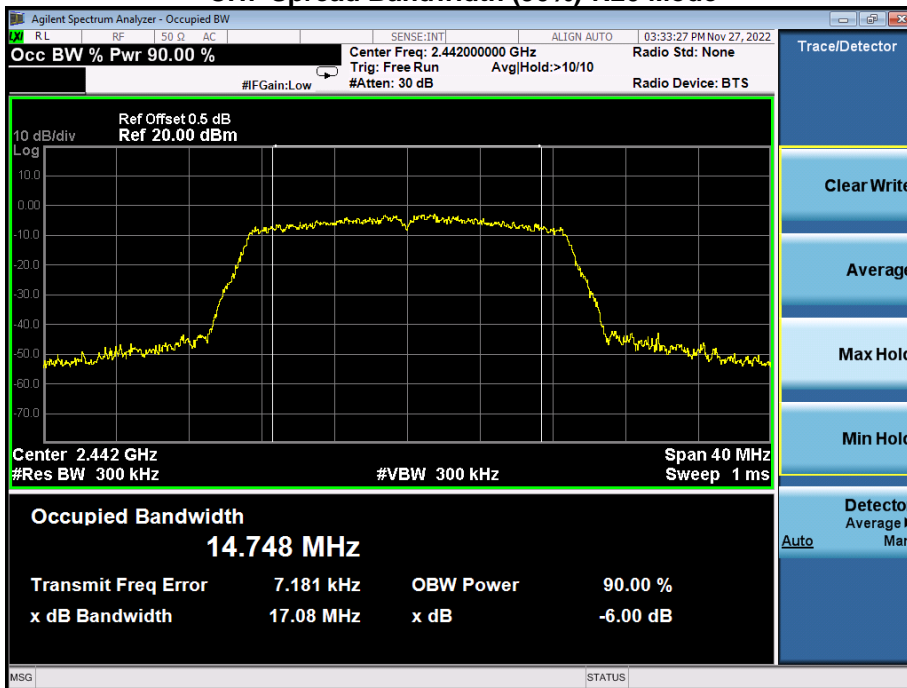
CH7-Spread Bandwidth (90%)-G Mode

CH13-Occupied Bandwidth (99%)-G Mode

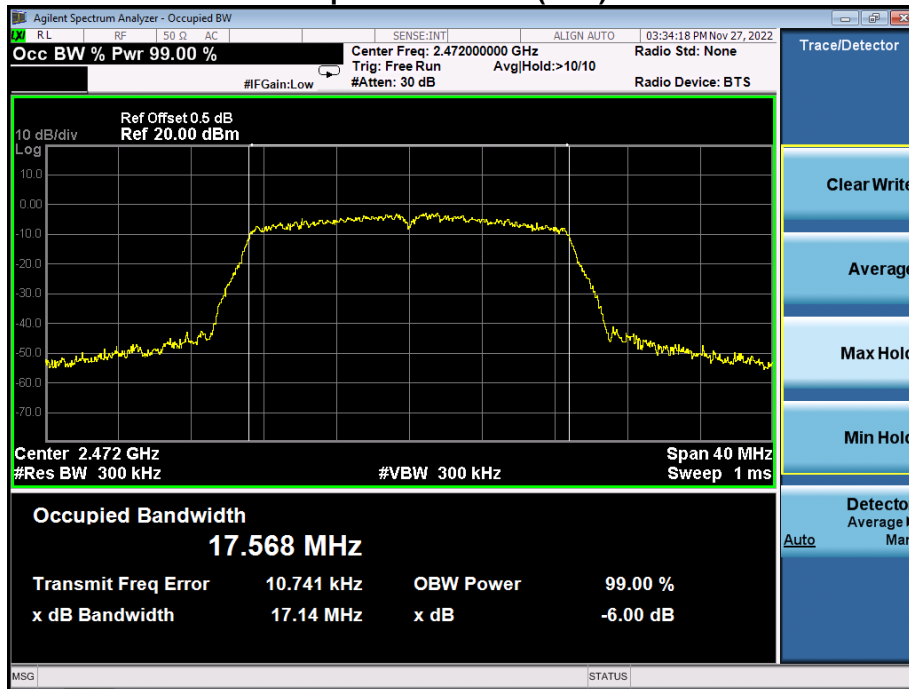
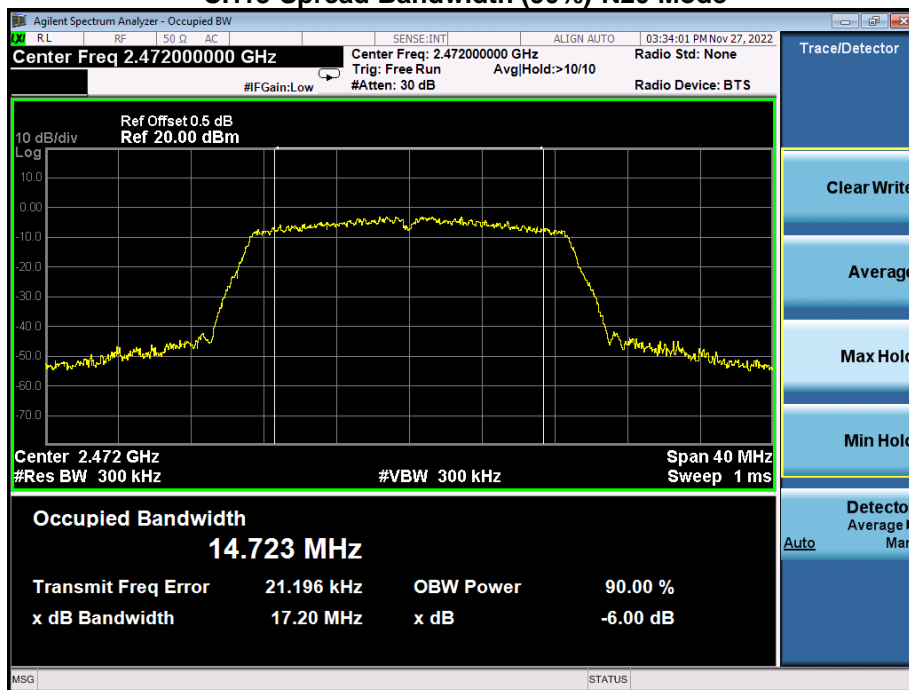
CH13-Spread Bandwidth (90%)-G Mode

CH1-Occupied Bandwidth (99%)-N20 Mode

CH1-Spread Bandwidth (90%)-N20 Mode

CH7-Occupied Bandwidth (99%)-N20 Mode

CH7-Spread Bandwidth (90%)-N20 Mode

CH13-Occupied Bandwidth (99%)-N20 Mode

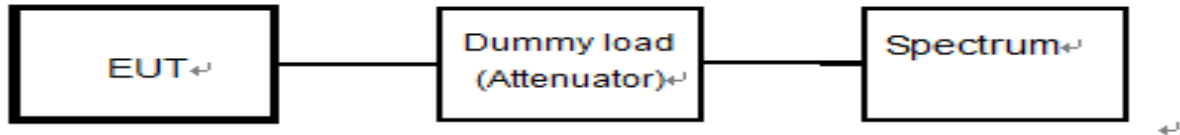
CH13-Spread Bandwidth (90%)-N20 Mode

10. Unwanted Emission Intensity Measurement

10.1 Block Diagram Of Test Setup



10.2 Limit

Item	Limits
TX Spurious Emission	$\leq 0.25 \mu\text{W}$ ($30\text{MHz} \leq f \leq 1000\text{MHz}$)
	$\leq 2.5 \mu\text{W}$ ($1000\text{MHz} < f \leq 2387\text{MHz}$)
	$\leq 25 \mu\text{W}$ ($2387\text{MHz} < f \leq 2400\text{MHz}$)
	$\leq 25 \mu\text{W}$ ($2483.5\text{MHz} \leq f < 2496.5\text{MHz}$)
	$\leq 2.5 \mu\text{W}$ ($2496.5\text{MHz} \leq f < 12500\text{MHz}$)

10.3 Measuring Instruments And Setting

Please refer to section 5 in this report. The following table is the setting of Spectrum Analyzer.

Spectrum Parameter	Setting
Attenuation	Auto
RB / VB	1 MHz
Detector	Peak
Trace	Max Hold
Sweep Time	Auto

10.4 Test Procedure

- EUT have transmitted the maximum modulation signal and fixed channelize.
- Setting of SA is following as: Below 1GHz RB:100KHz / VB:100KHz
Above 1GHz RB:1MHz / VB:1MHz / AT: 20dB Ref: 10dBm / Sweep time: Auto
Sweep Mode: Continuous sweep / Detect mode: Positive peak
Trace mode: Max hold
- Setting of SA is following as 30MHz and stop frequency 1000MHz Then to mark peak reading value + cable loss shall be less than 0.25 μW .
- Setting of SA is following as 1000MHz and stop frequency 2387MHz Then to mark peak reading value + cable loss shall be less than 2.5 μW .
- SA adjusted to start frequency 2387MHz and stop frequency 2400MHz. Then to mark peak reading value + cable loss shall be less than 25 μW .
- SA adjusted to start frequency 2483.5MHz and stop frequency 2496.5MHz Then to mark peak reading value + cable loss shall be less than 25 μW
- SA adjusted to start frequency 2496.5MHz and stop frequency 12500MHz Then to

mark peak reading value + cable loss shall be less than $2.5\mu\text{W}$

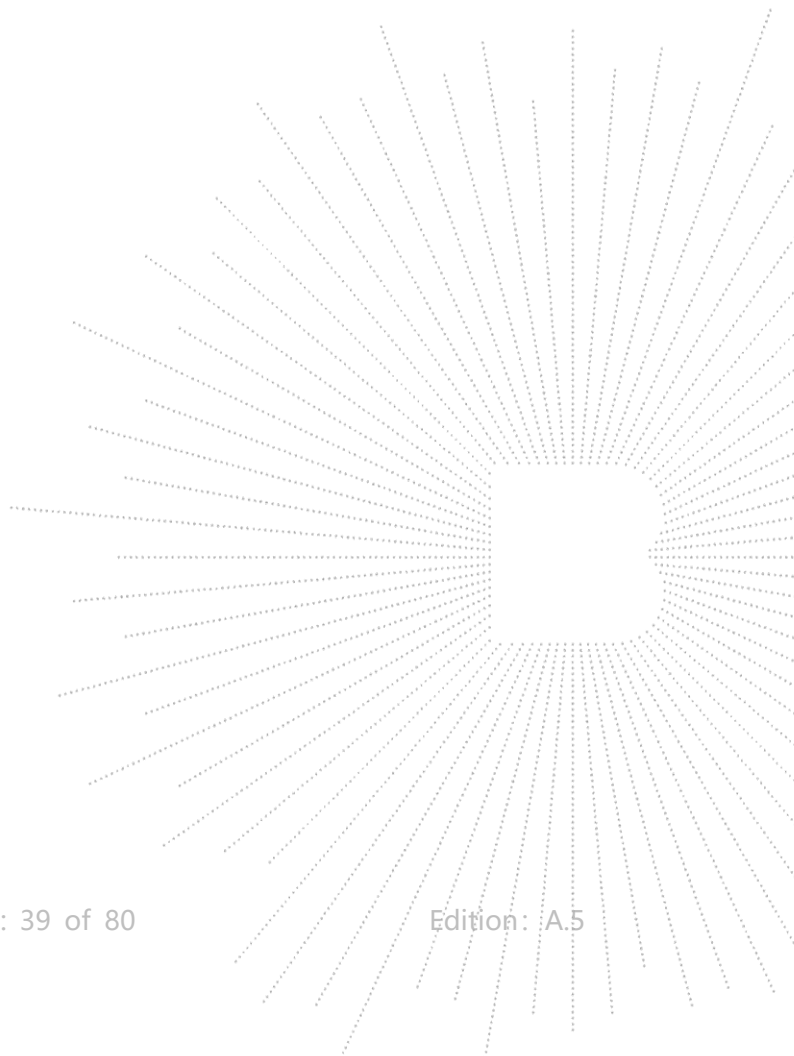

10.5 Test Result

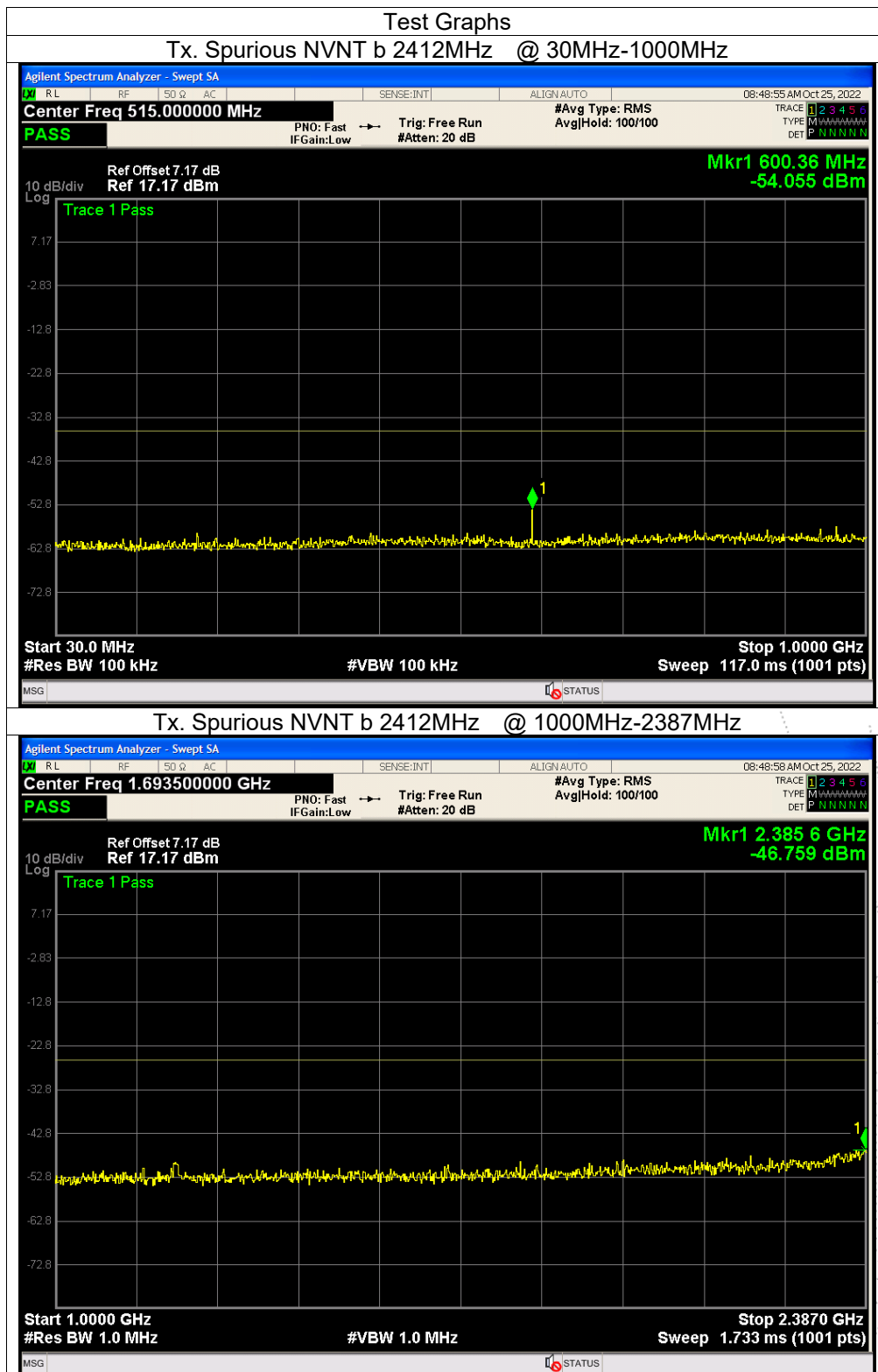

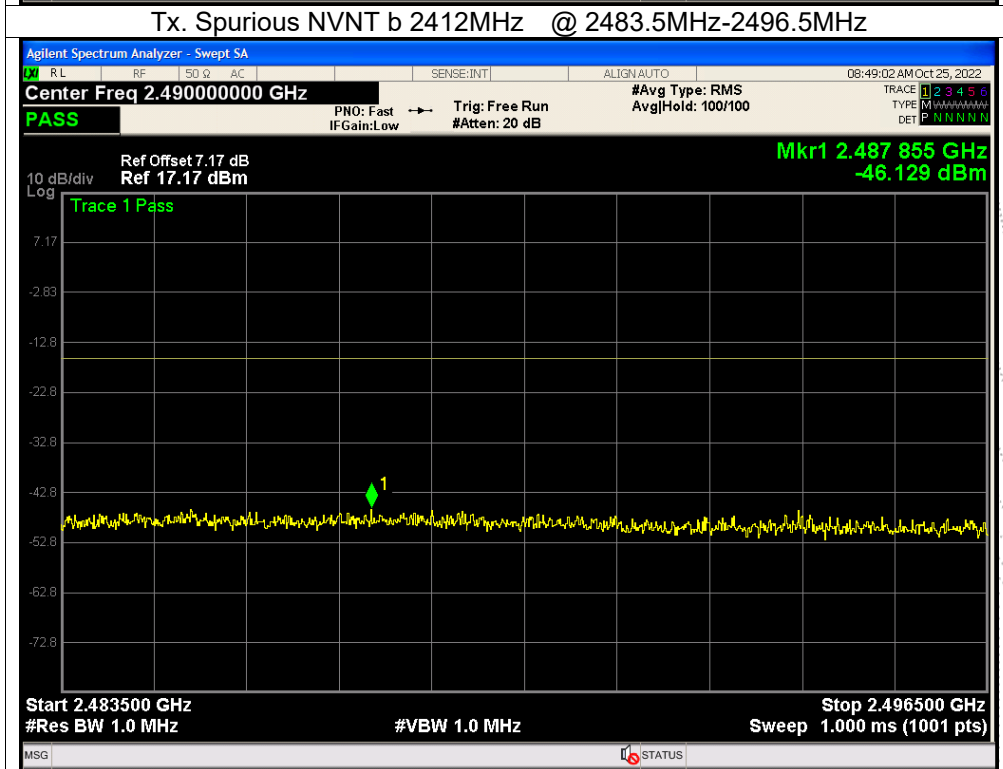
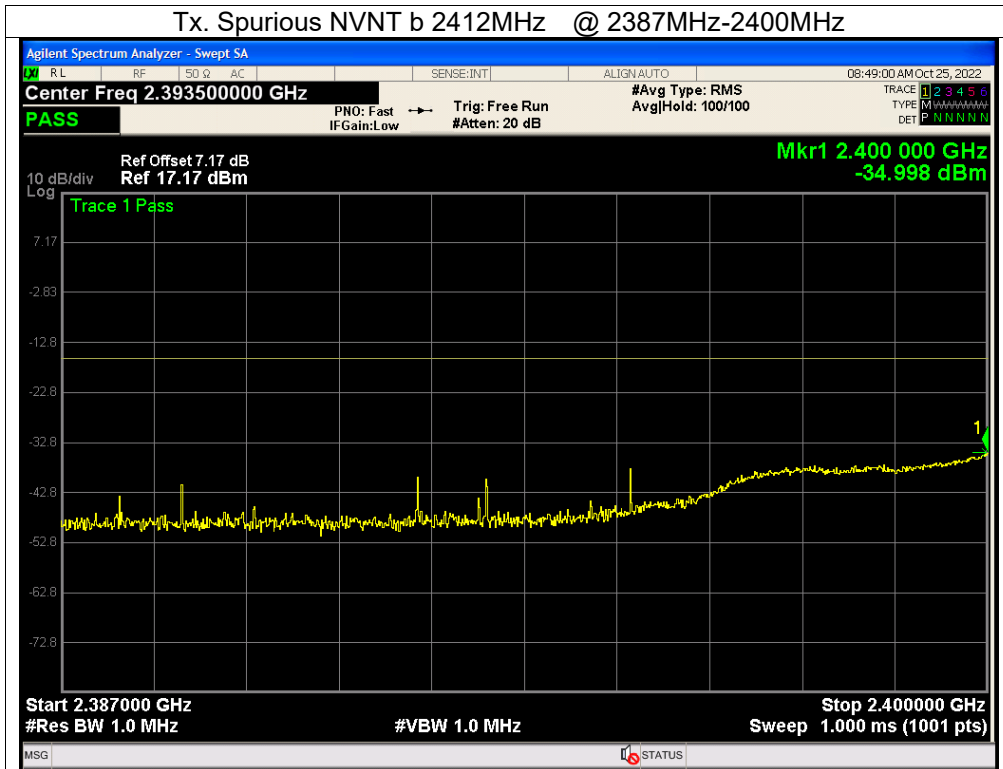

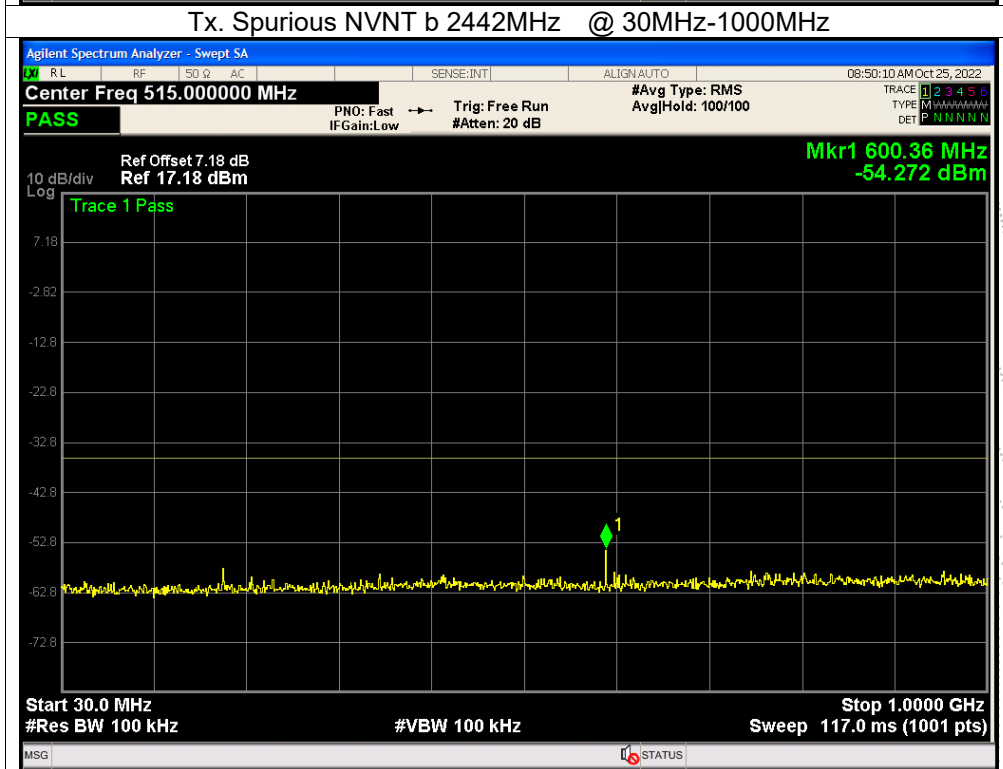

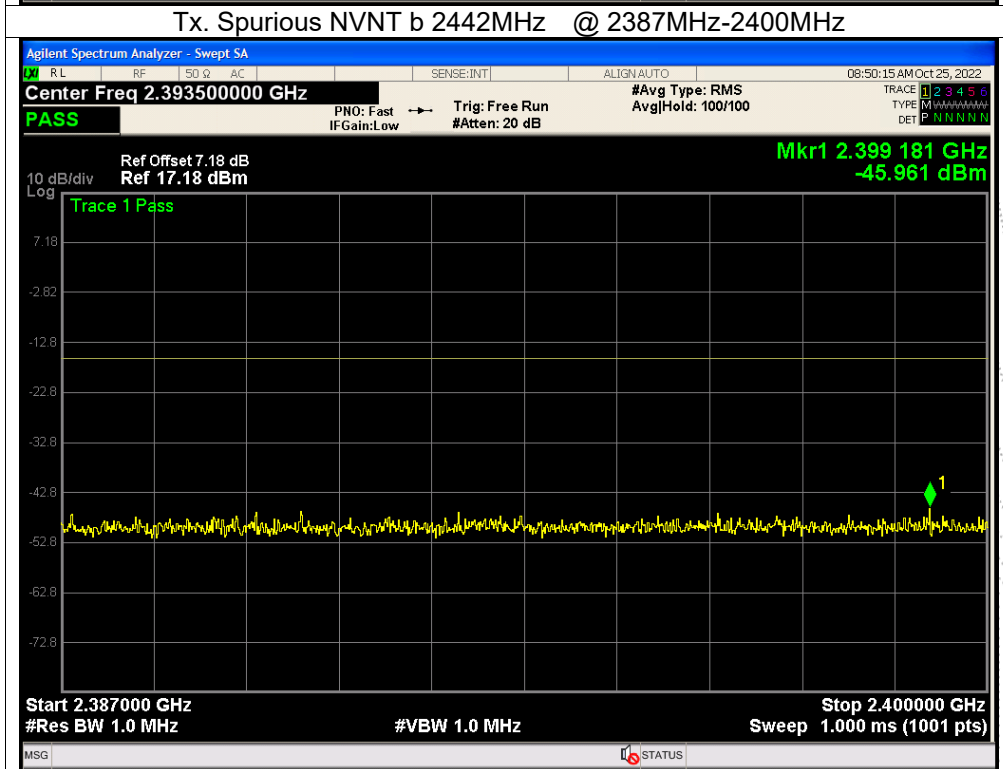
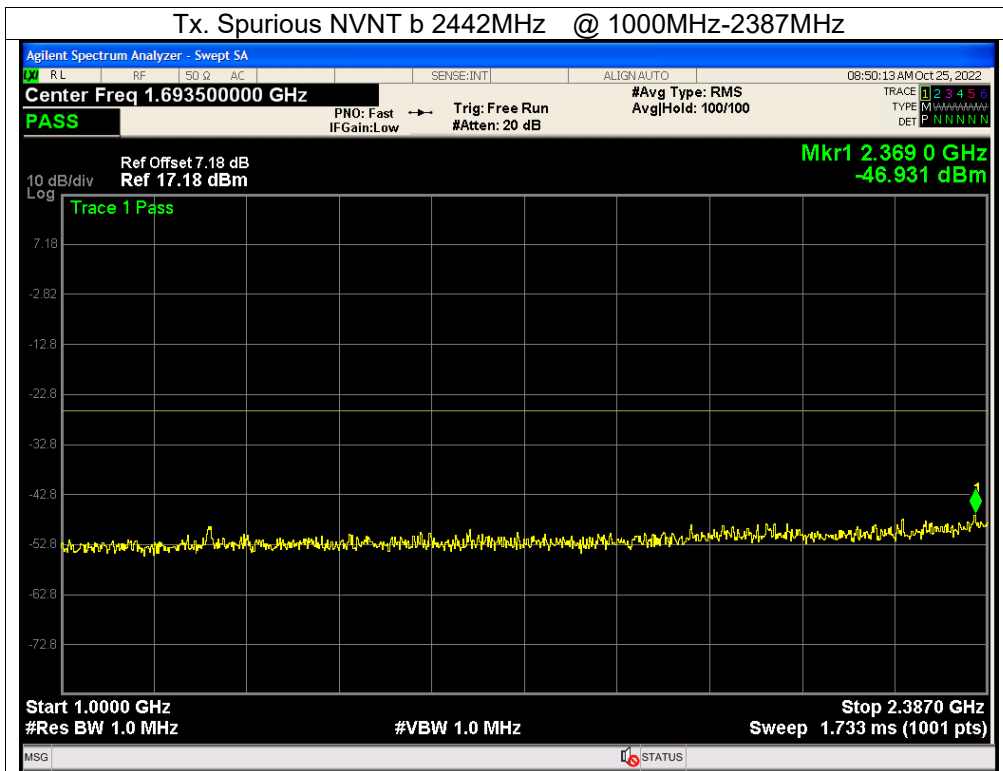

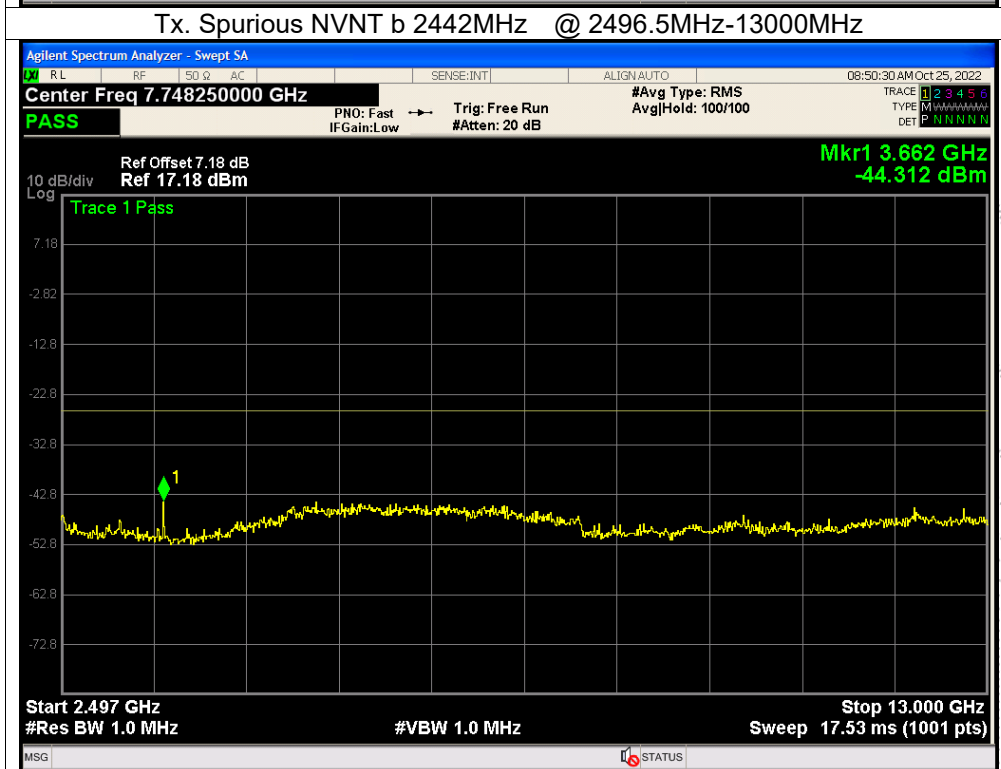
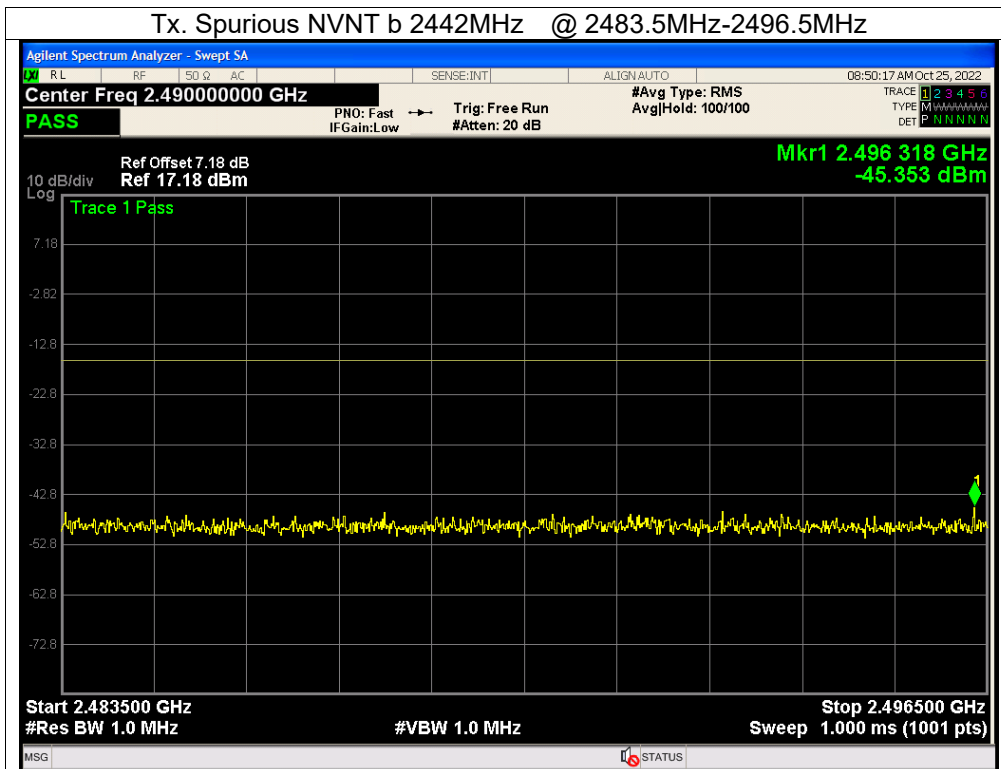

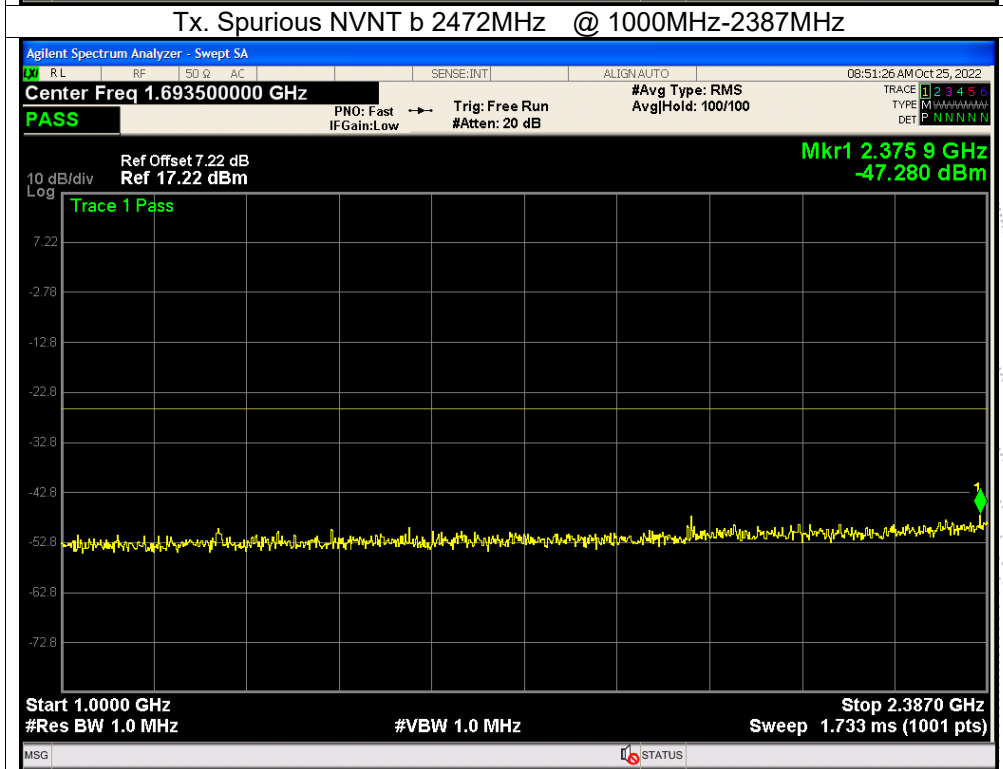
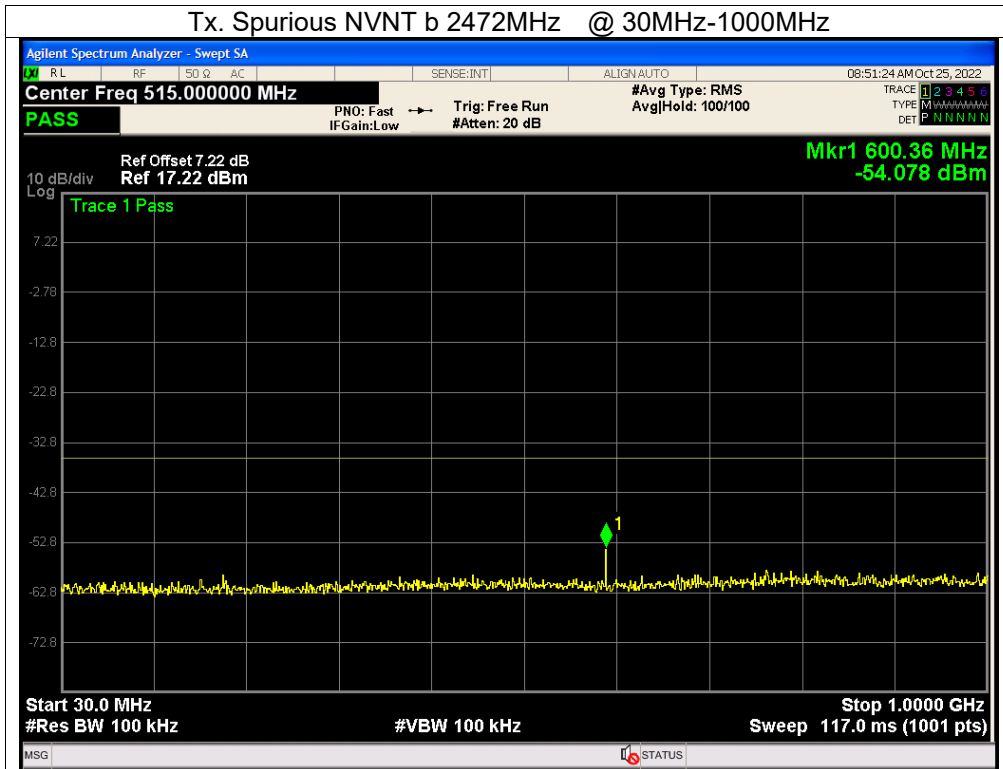

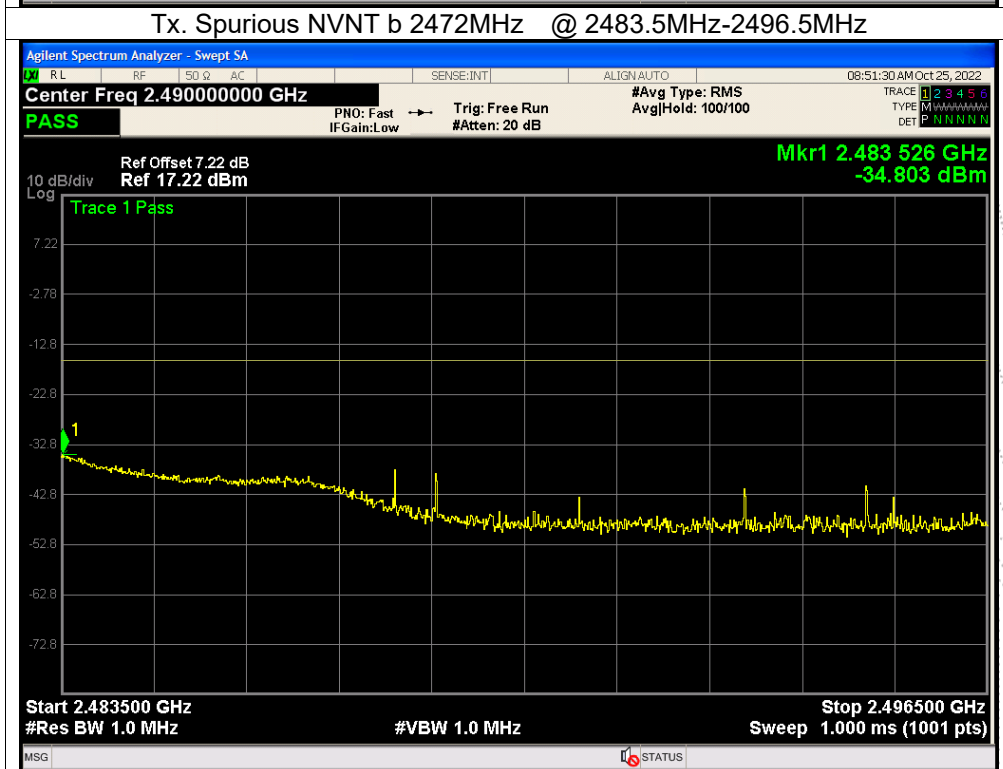
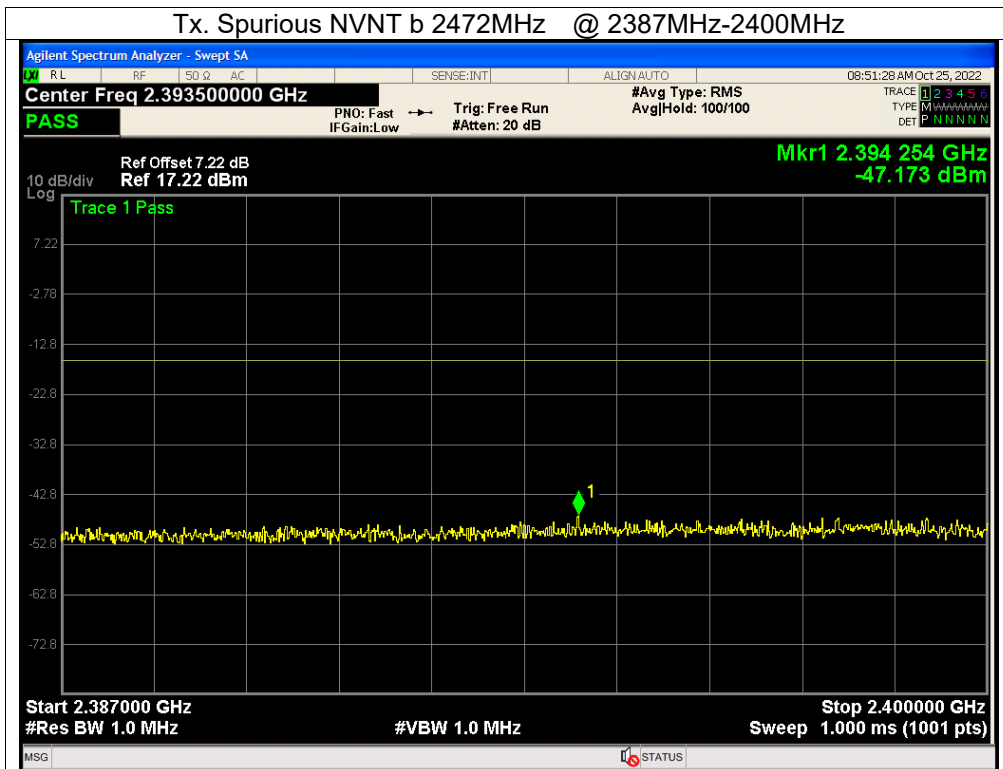

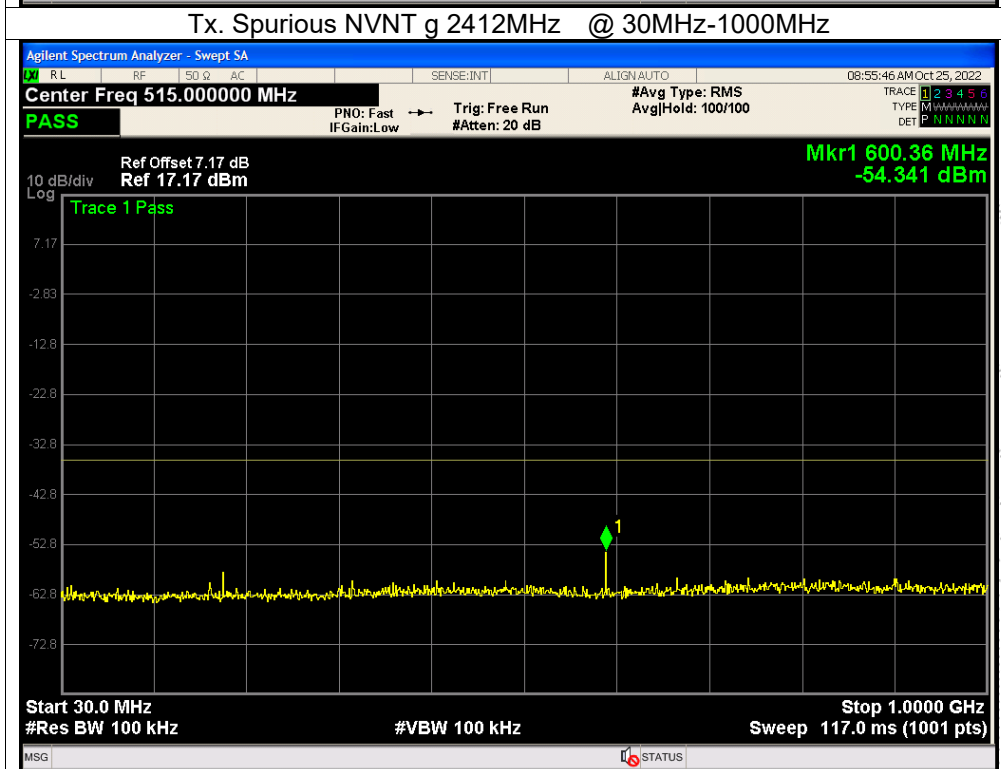
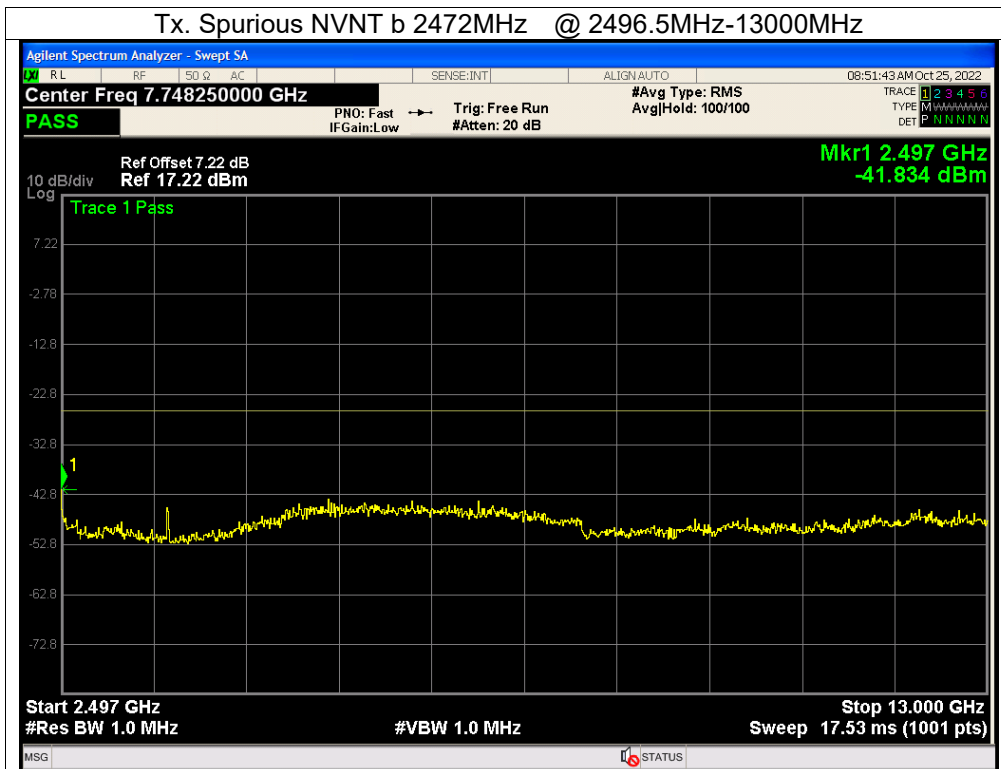

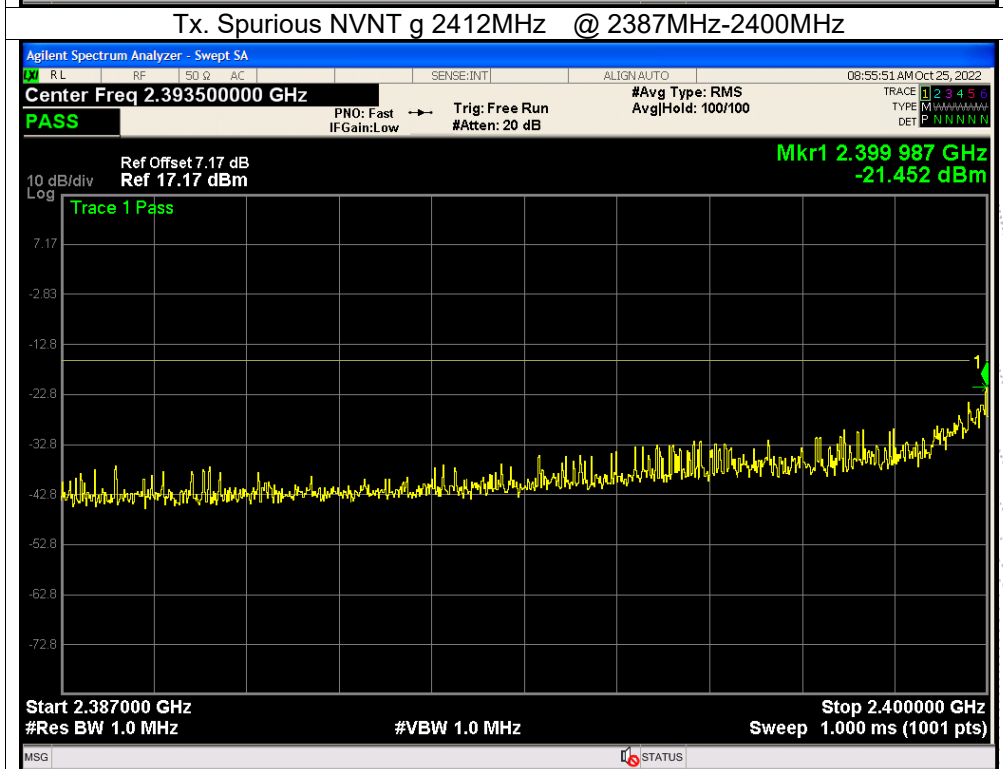
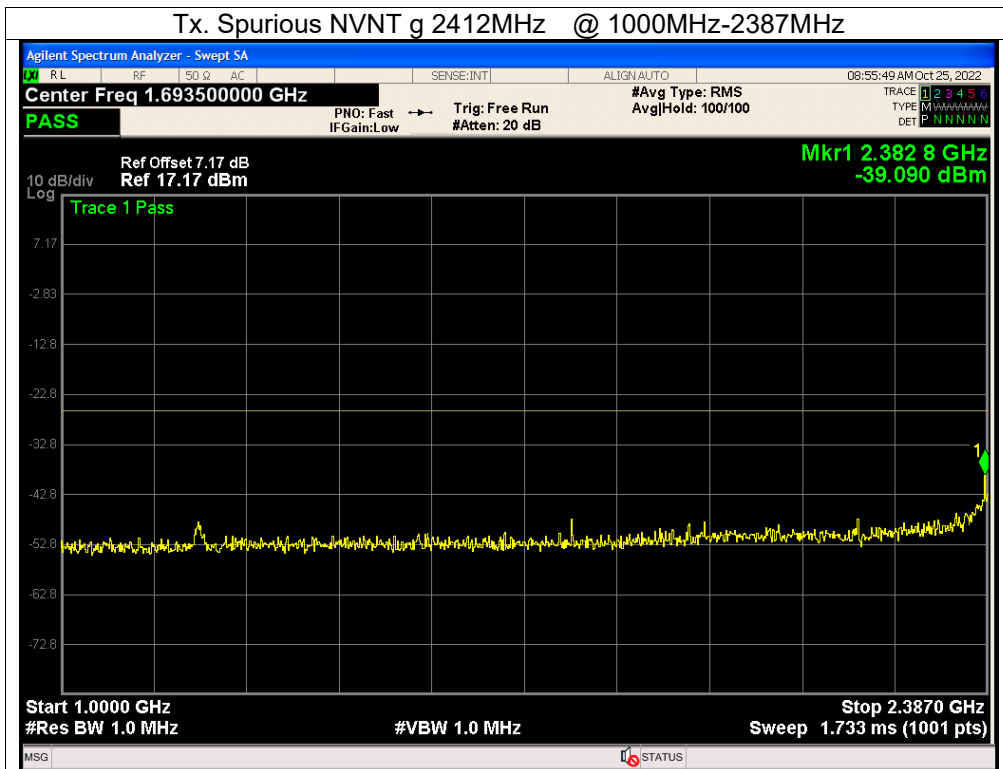

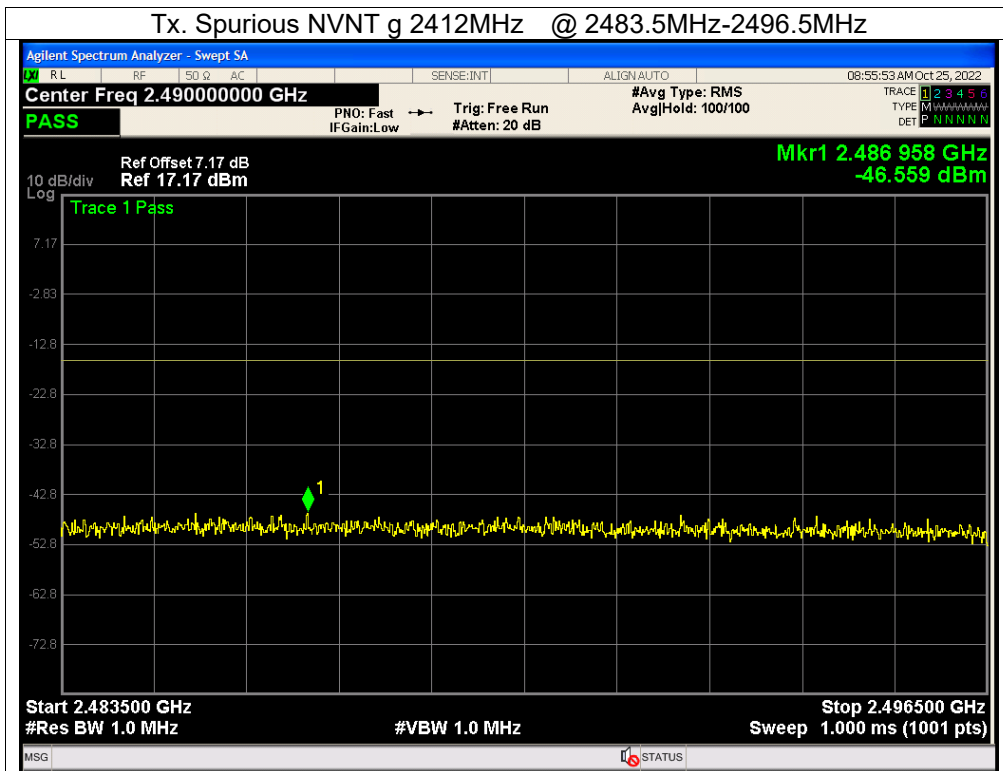

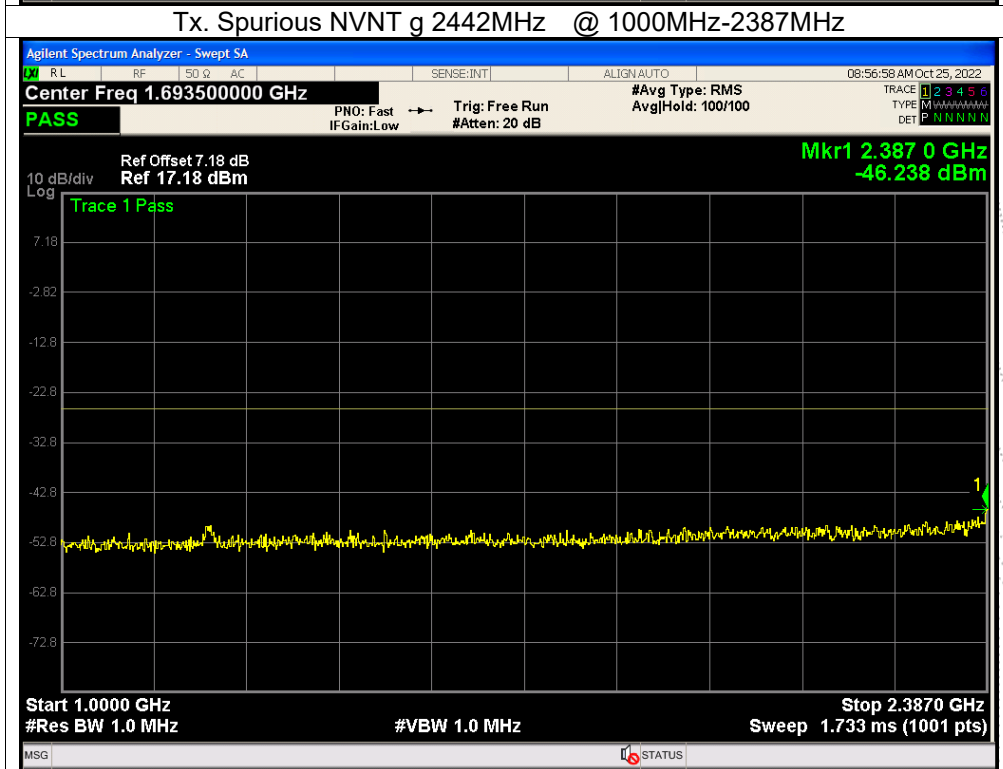
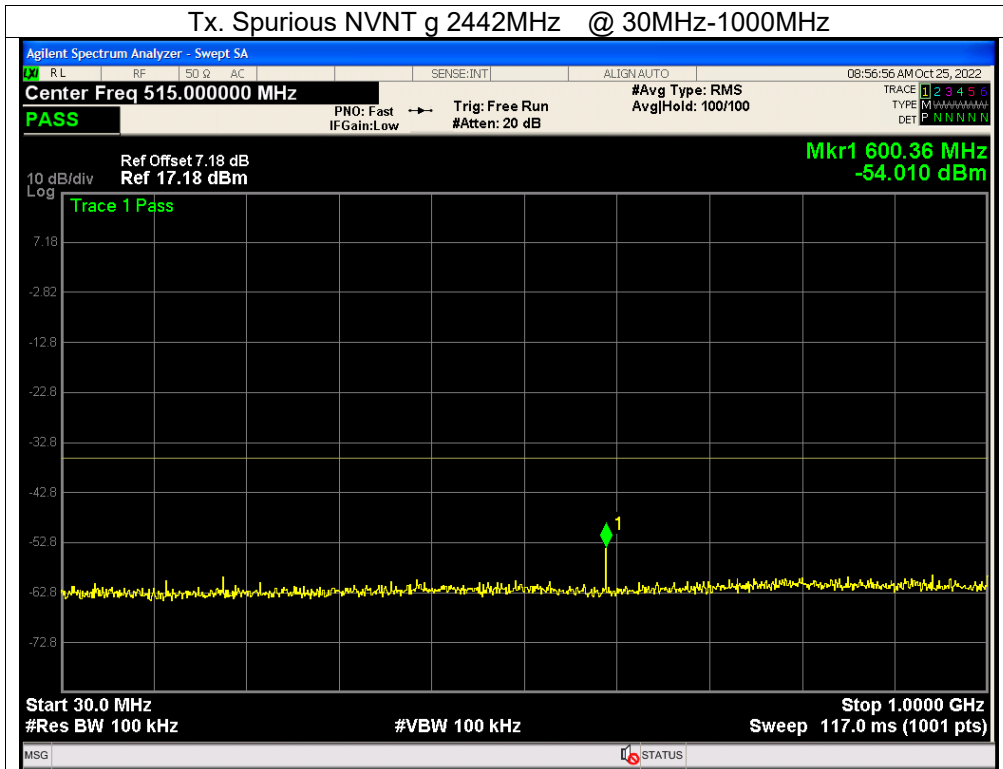

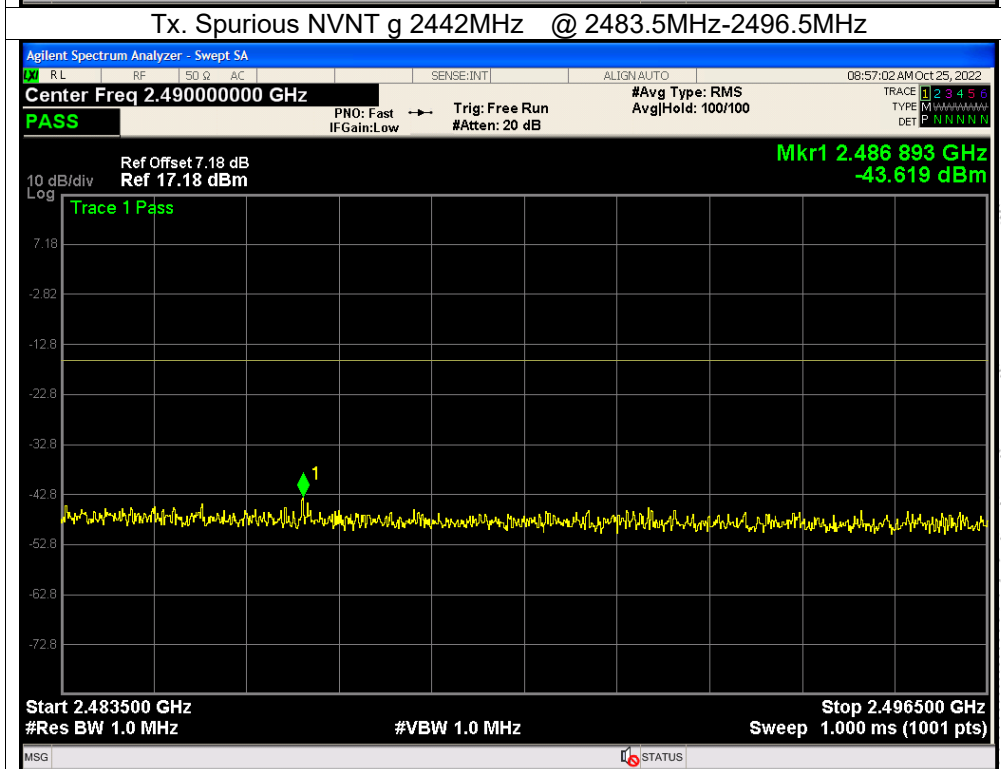
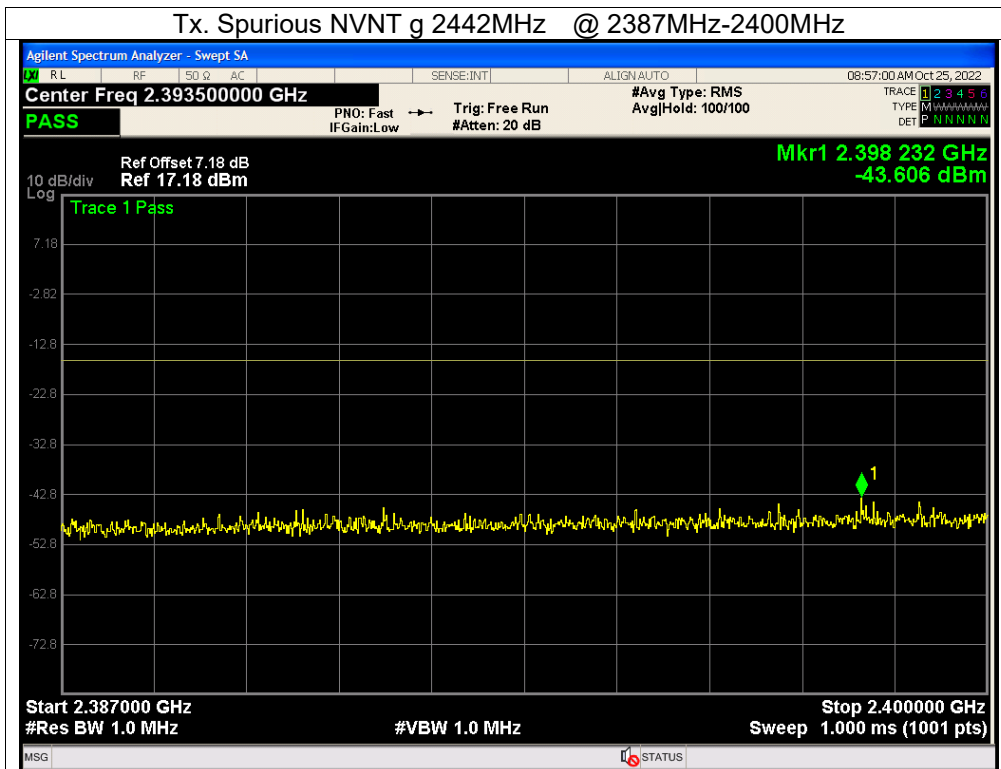

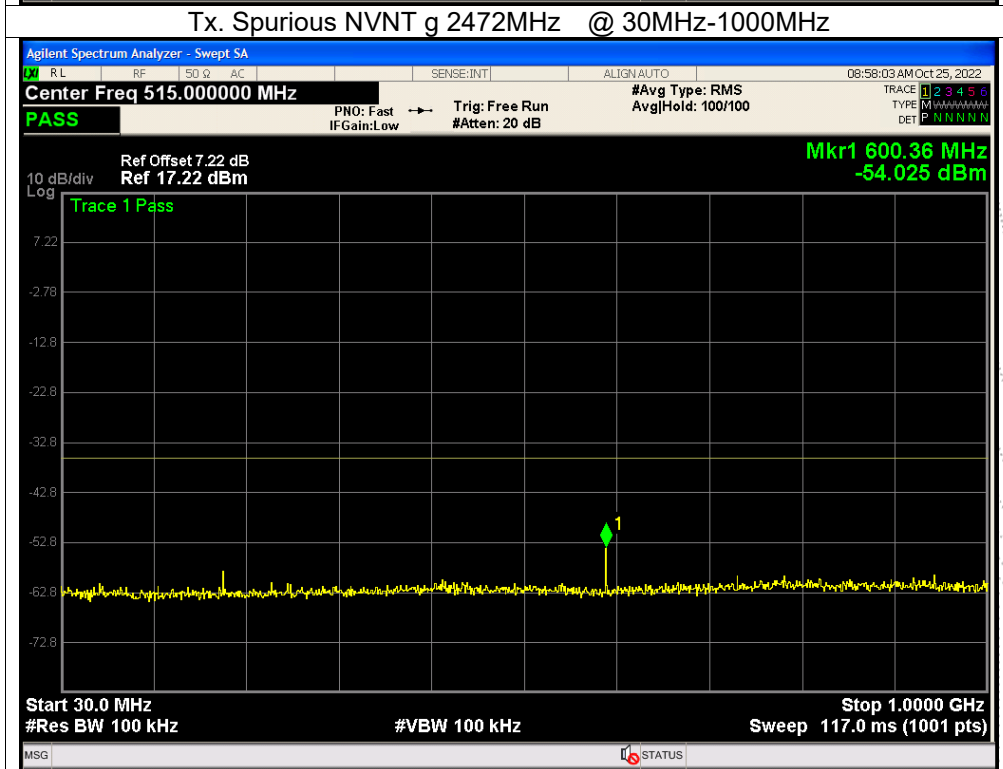
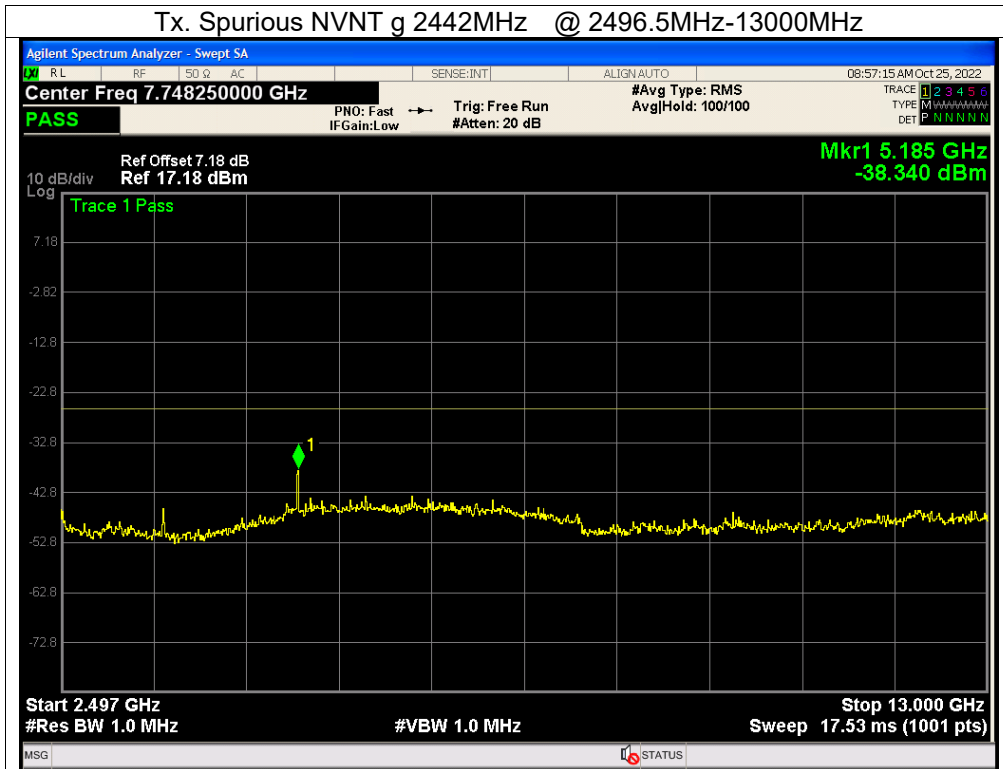

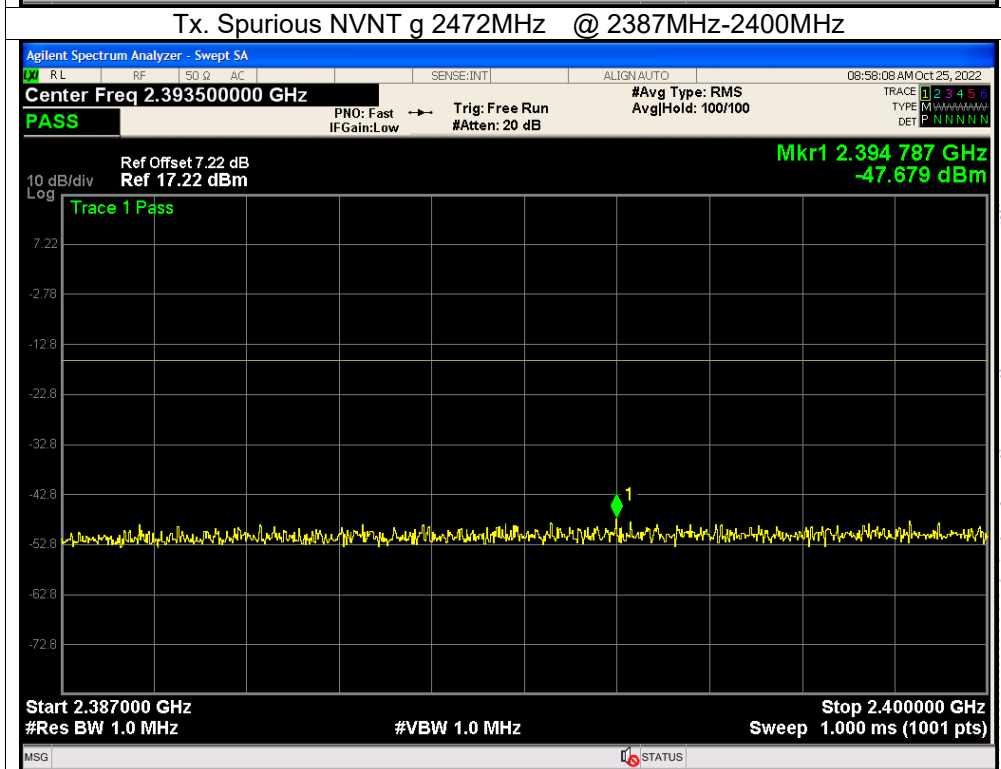
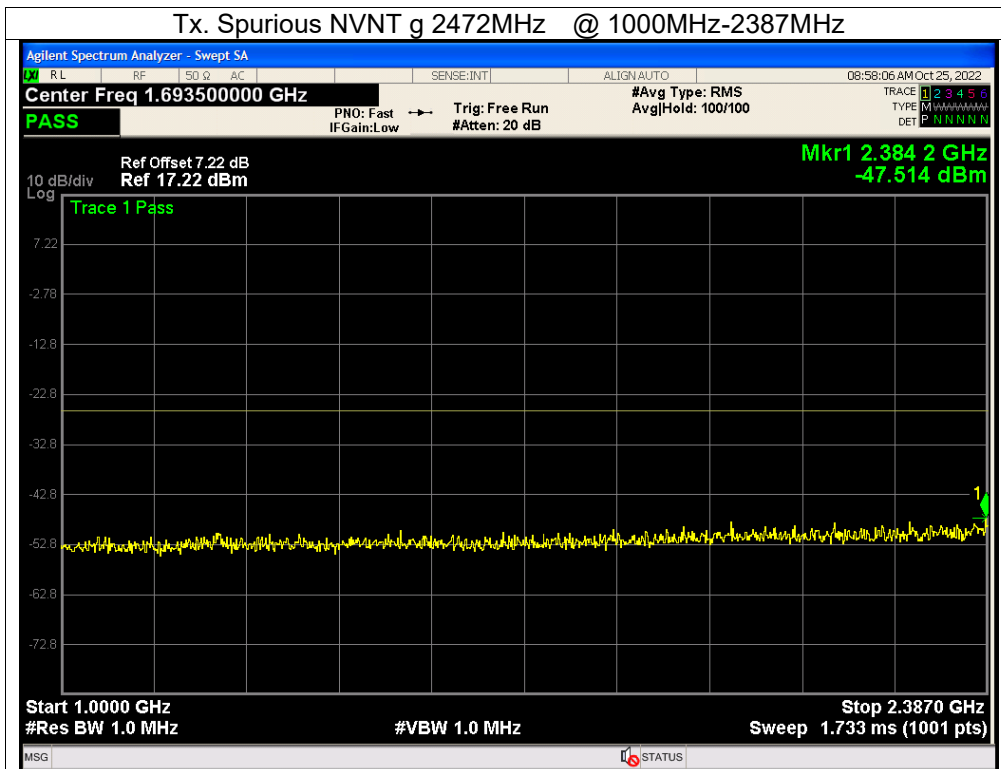

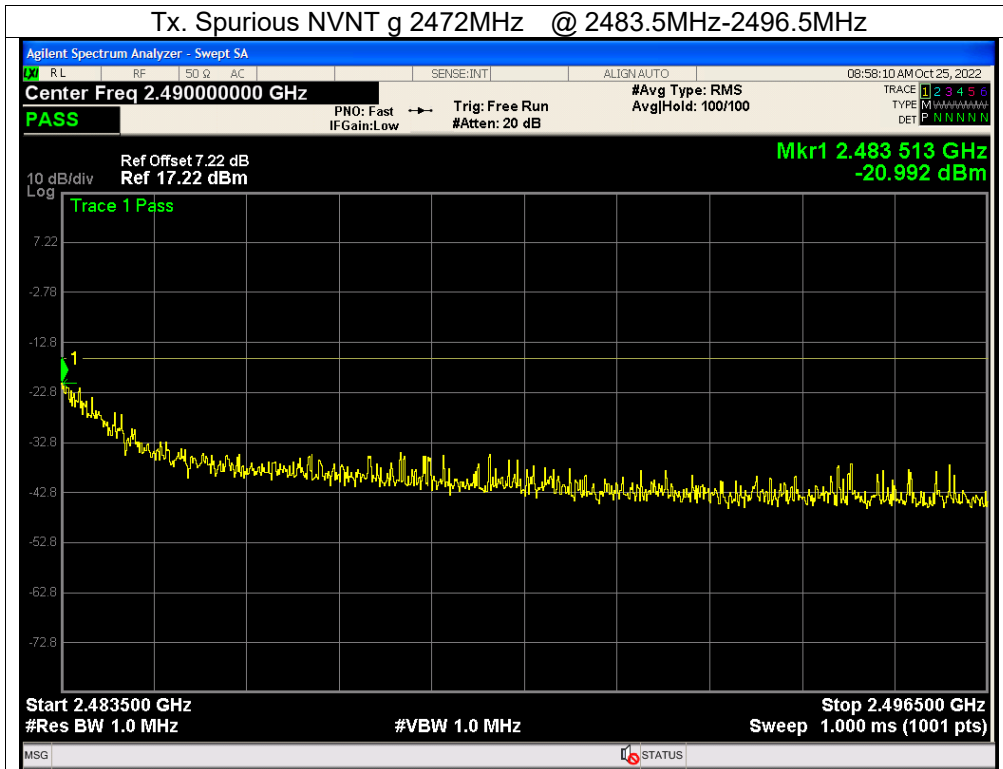

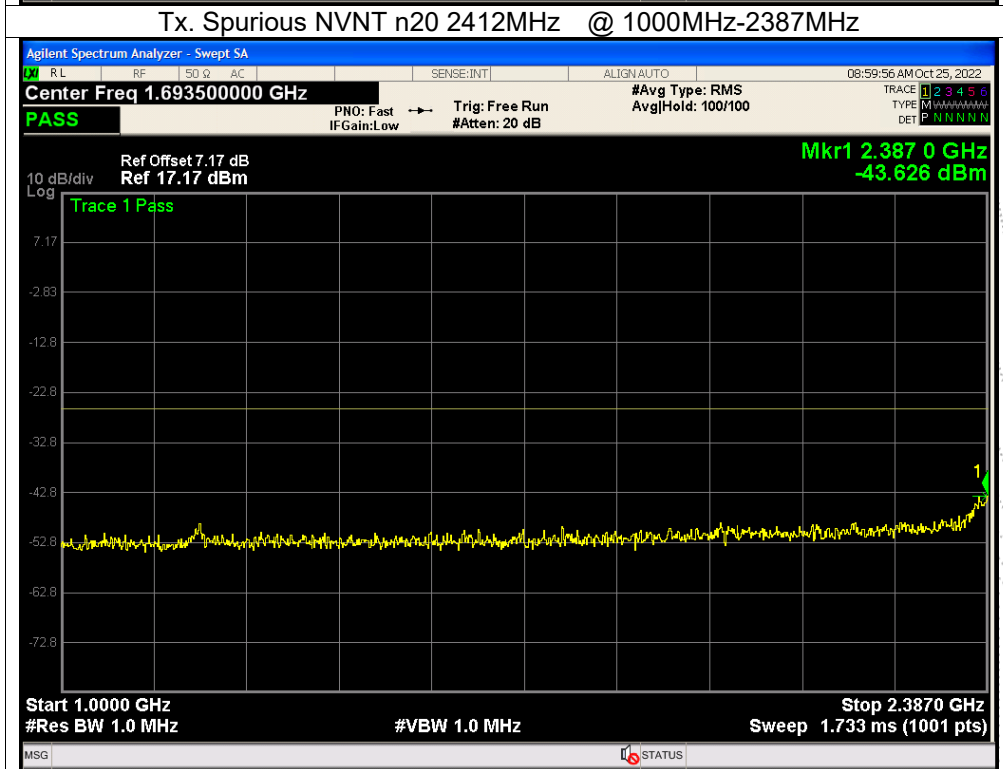
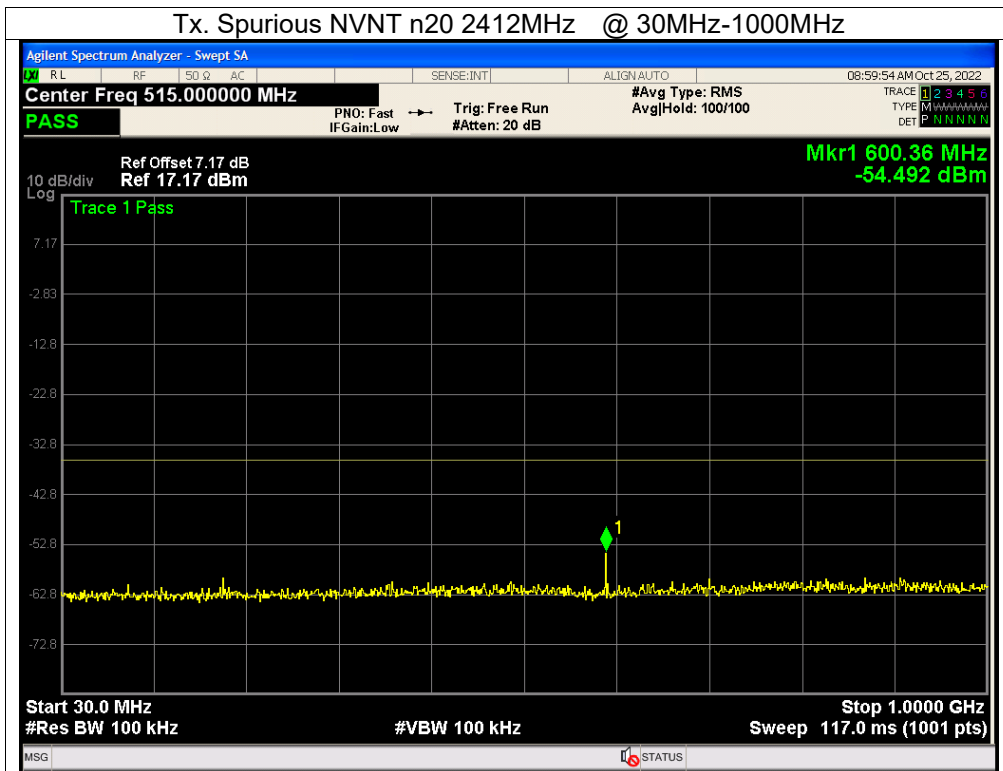

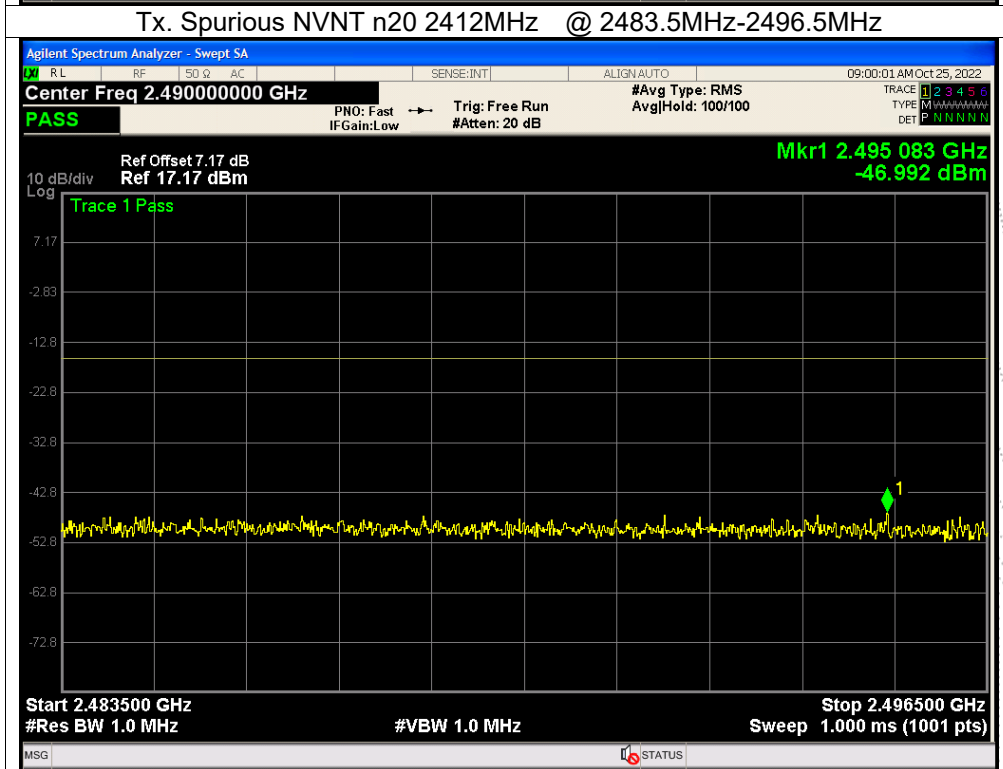
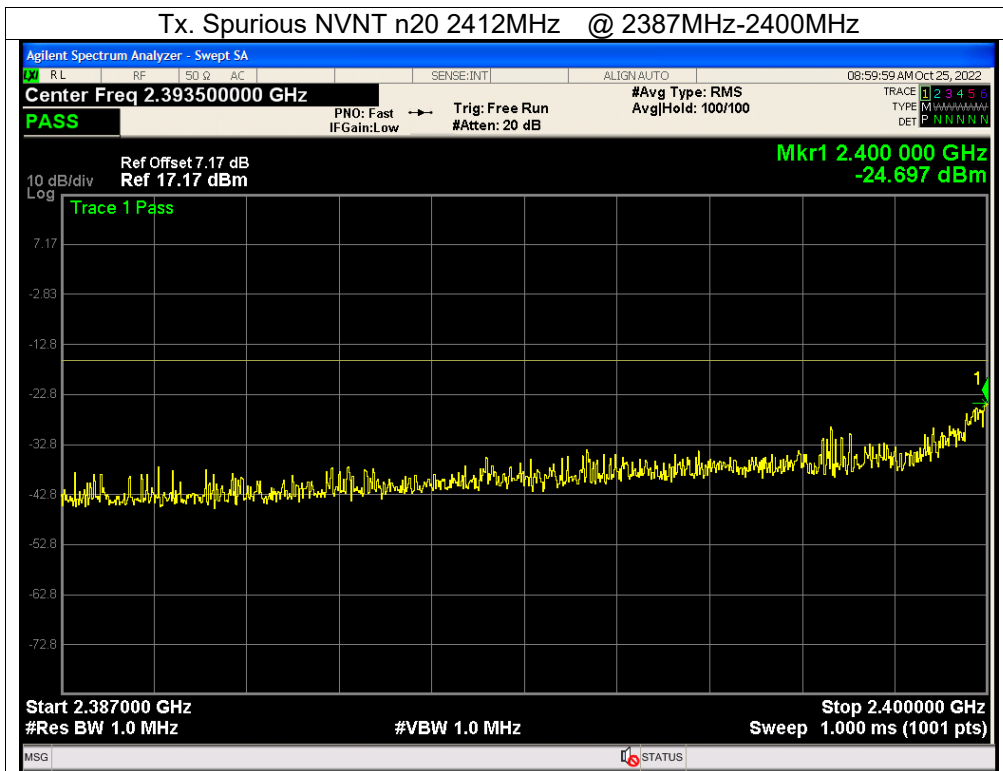

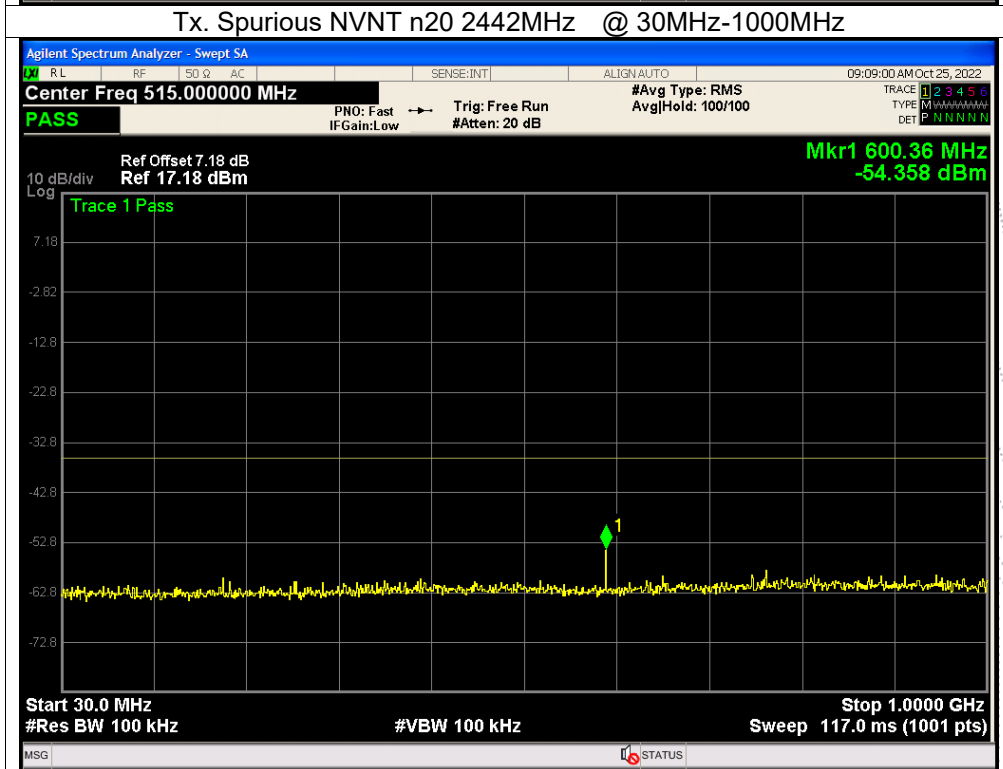
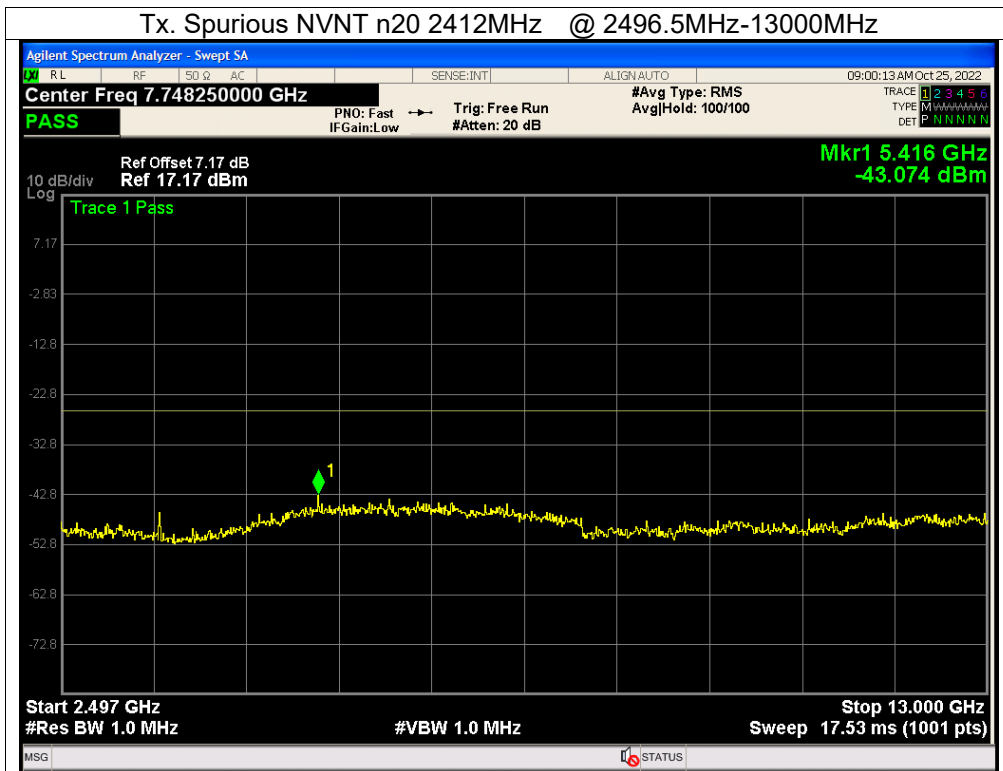

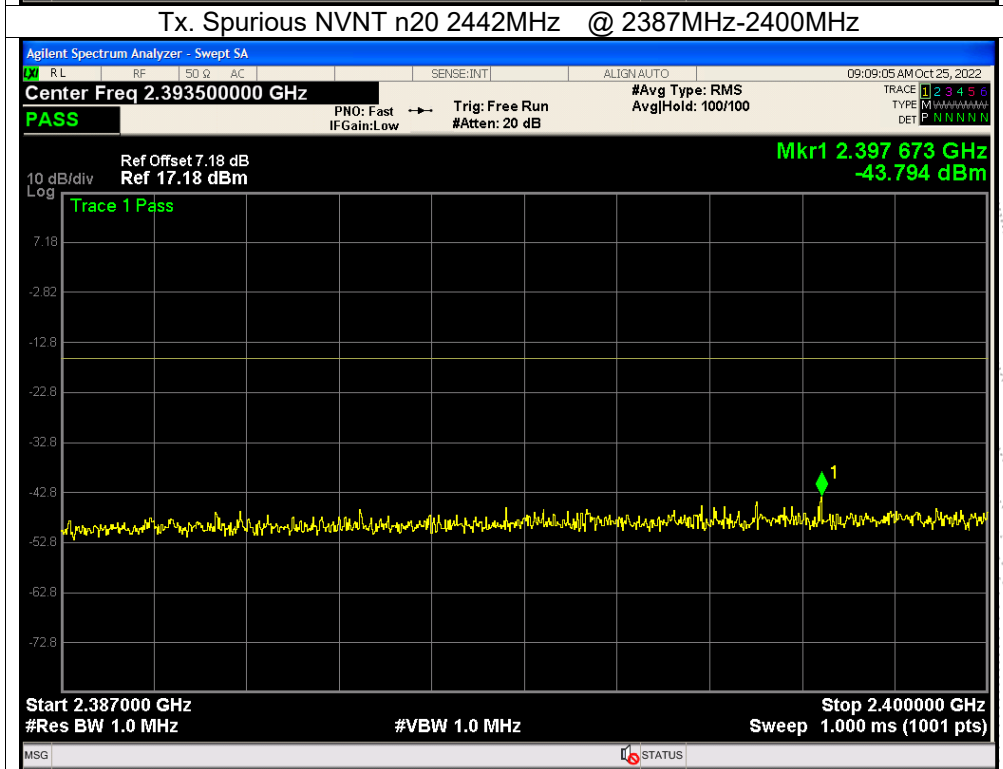
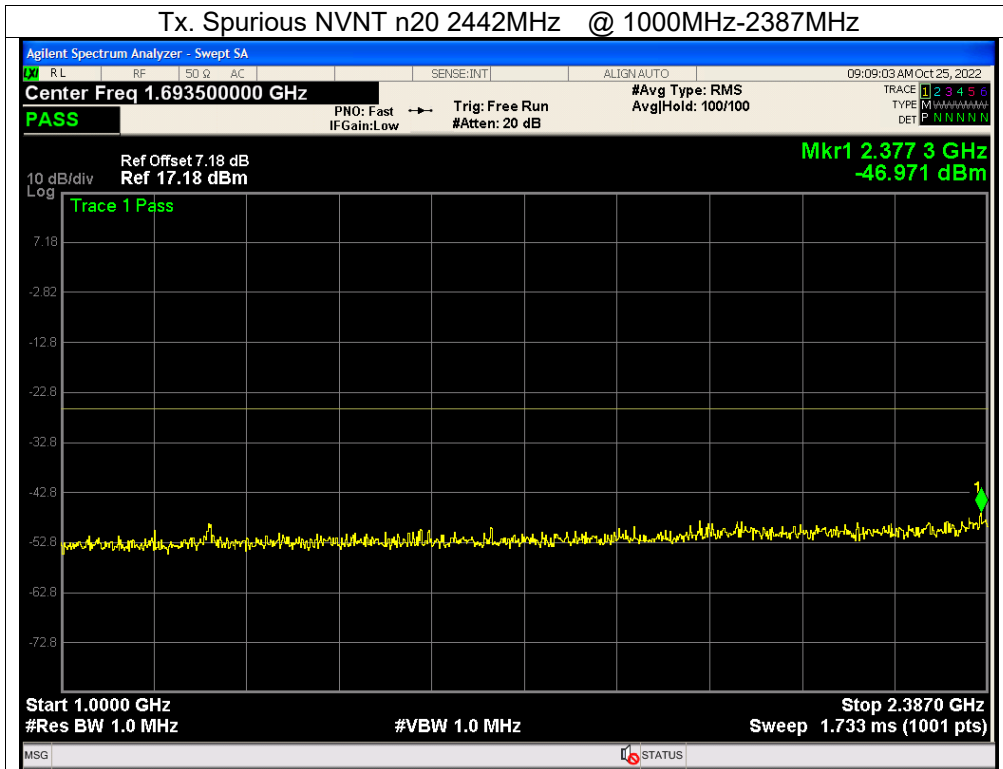

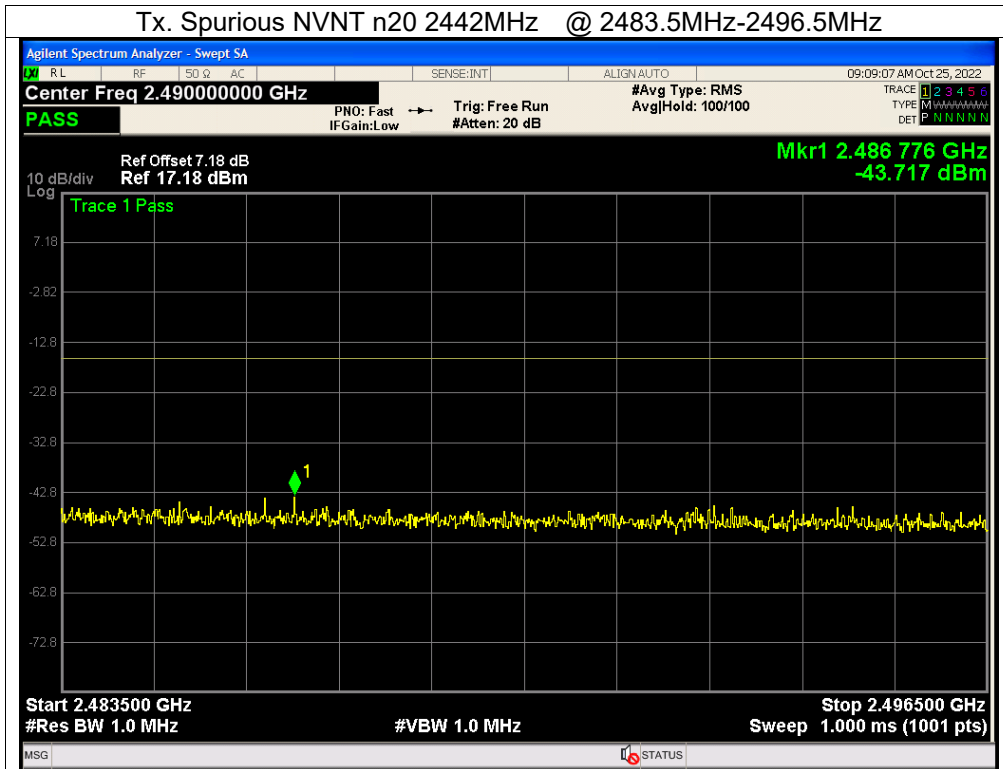

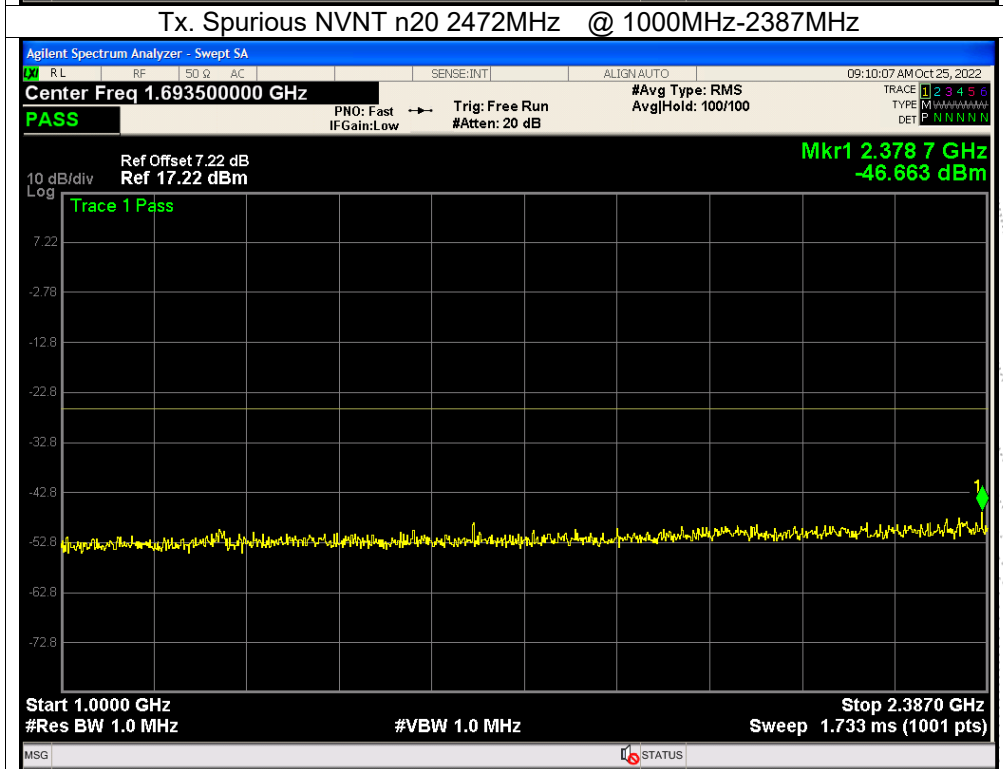
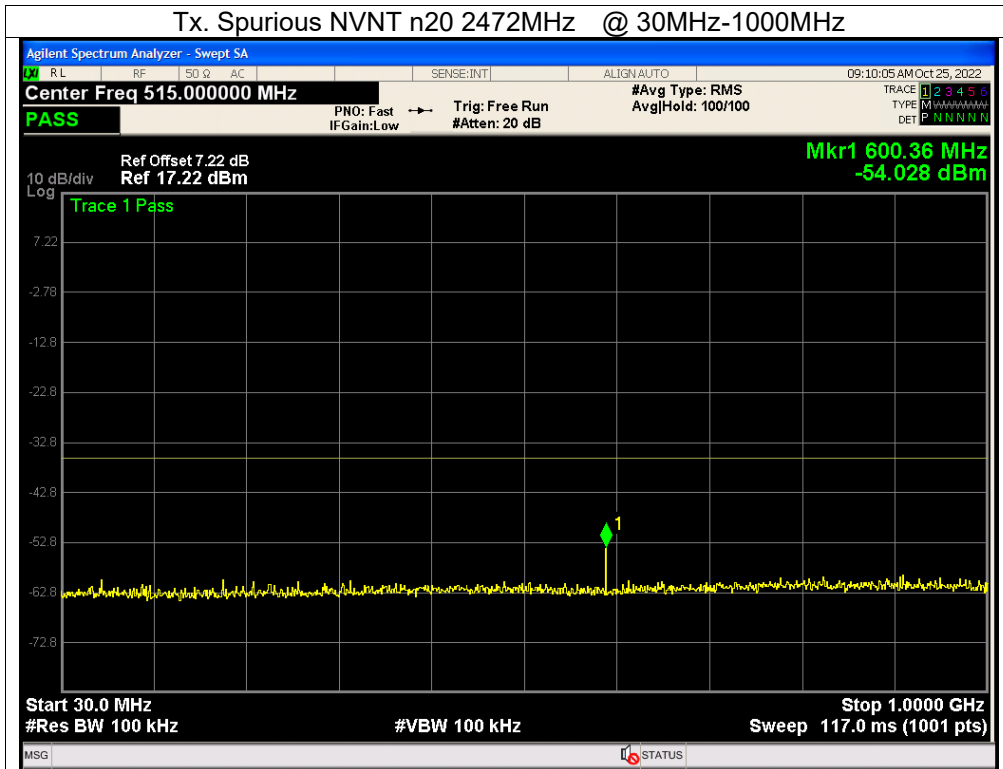

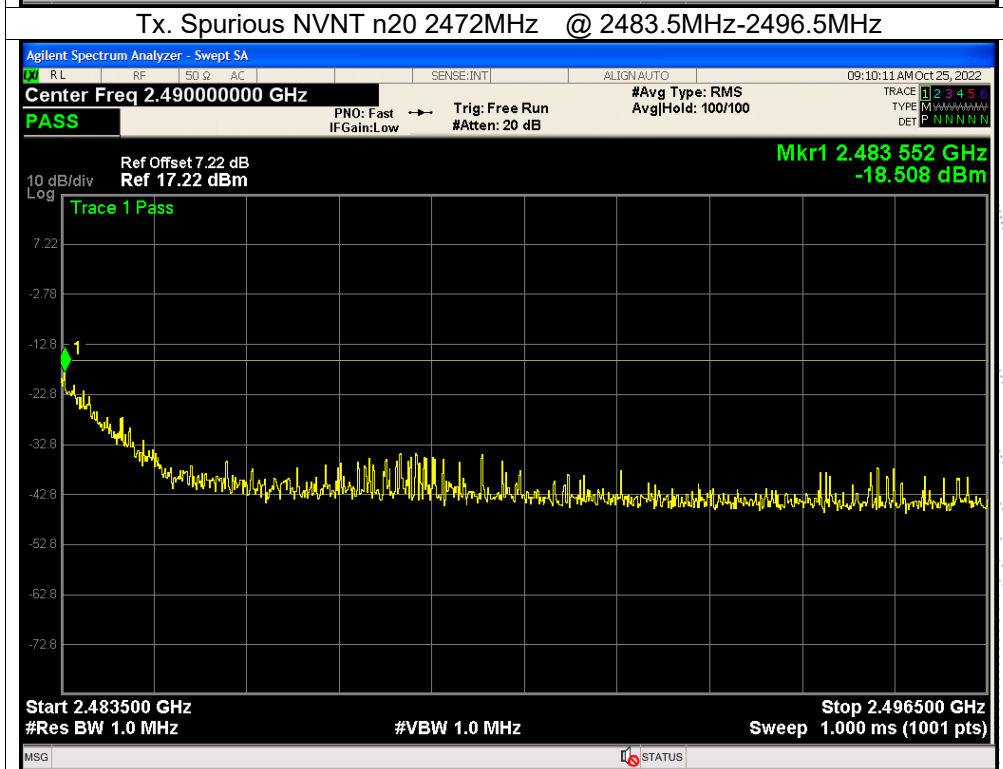
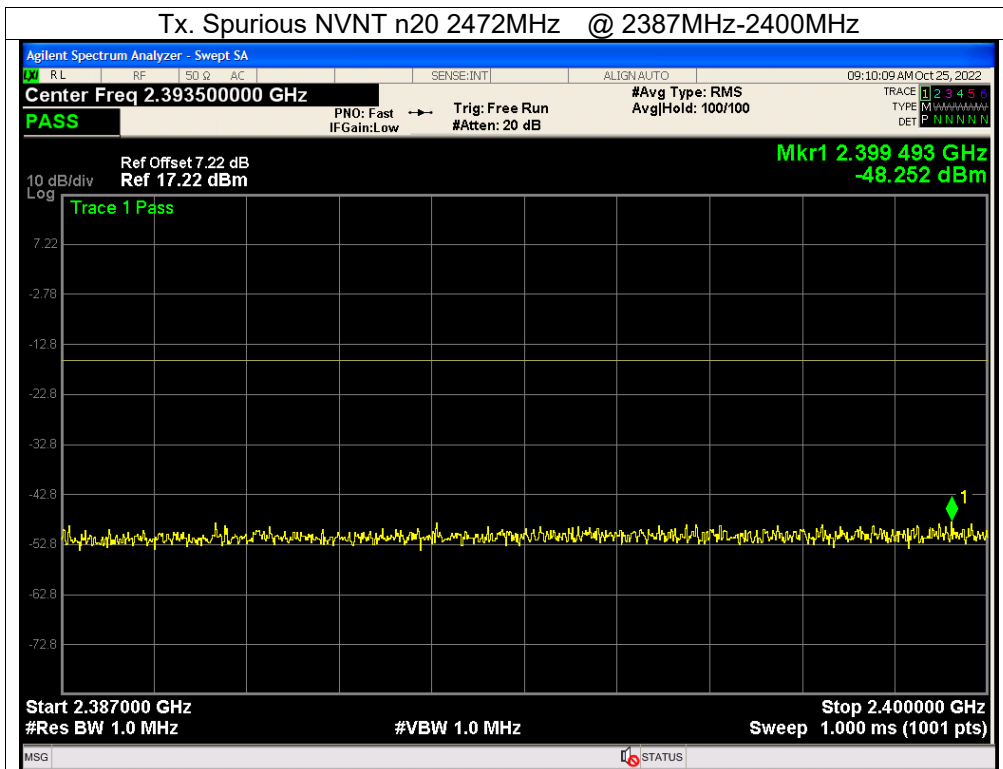

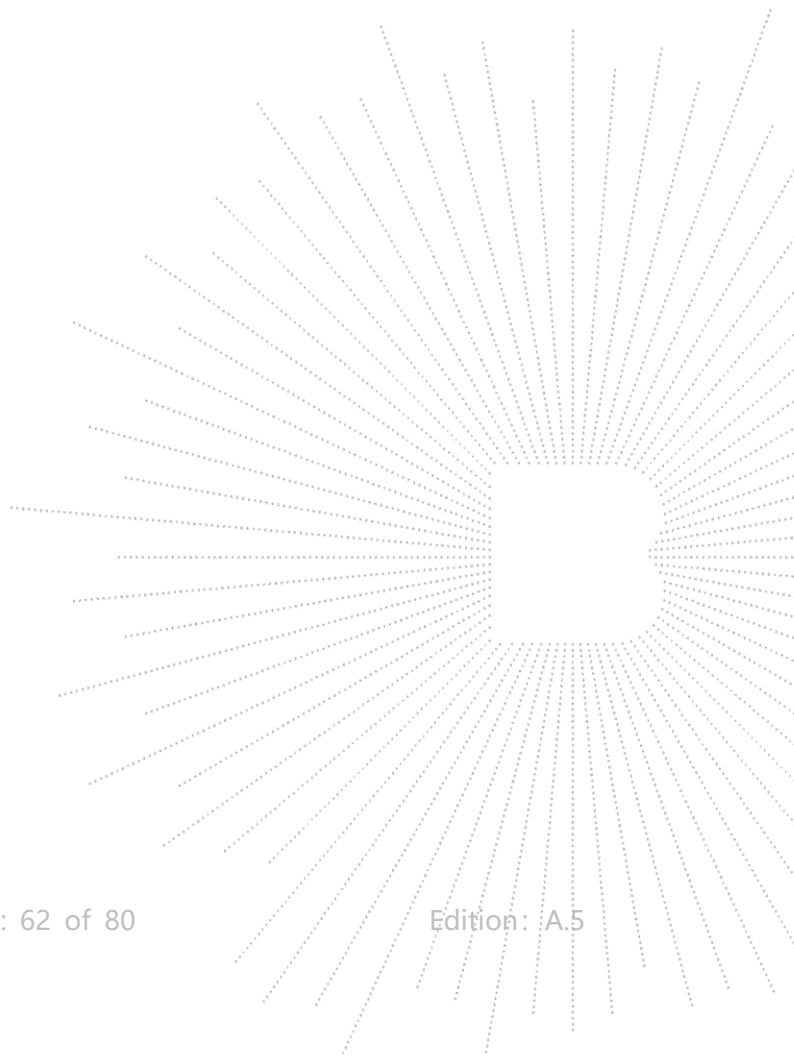
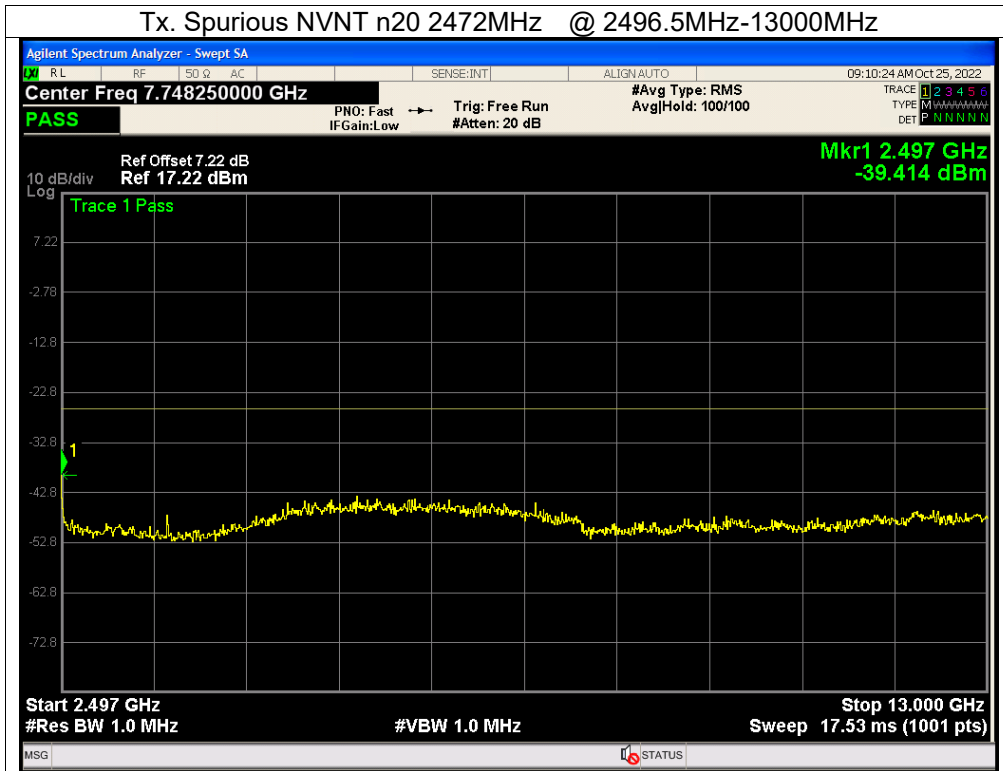

11. Imitation Of Collateral Emission Of Receiver Measurement

11.1 Block Diagram Of Test Setup

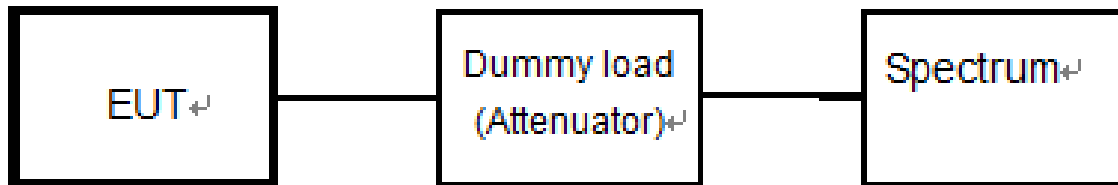

11.2 Limit

Item	Limits
RX Spurious Emission:	$\leq 4\text{nW}$ ($f < 1\text{GHz}$)
	$\leq 20\text{nW}$ ($1\text{GHz} \leq f$)

11.3 Measuring Instruments And Setting

Please refer to section 5 in this report. The following table is the setting of Spectrum Analyzer.

Spectrum Parameter	Setting
Attenuation	Auto
RB	100 kHz (below 1GHz emissions) 1 MHz (above 1GHz emissions)
VB	100 kHz (below 1GHz emissions) 1 MHz (above 1GHz emissions)
Detector	Peak
Trace	Max Hold
Sweep Time	Auto

11.4 Test Procedure

- EUT have the continuous reception mode and fixed only one channelize.
- Setting of SA is following as RB / VB: 100 kHz (below 1GHz emissions) / 1 MHz (above 1GHz emissions) / AT: 6dB / Ref: -20dBm / Sweep time: Auto / Sweep Mode: Continuous sweep / Detect mode: Positive peak / Trace mode: Max hold
- SA set RB: 100kHz and VB: 100kHz. Then adjust to start frequency 30MHz and stop frequency 1000MHz. Search to mark peak reading value + cable loss shall be less than 4nW
- SA set RB: 1MHz and VB: 1MHz. Then adjust to start frequency 1000MHz and stop frequency 12500MHz. Search to mark peak reading value + cable loss shall be less than 20nW
- If power level of lower emissions are more than 1/10 of limit (.0.4nW for $f < 1\text{GHz}$, 2nW for $f \geq 1\text{GHz}$), all those are to be indicated in the 2nd and 3rd lines. If others are 1/10 or less more of the limit, no necessary to be indicated.

11.5 Test Result

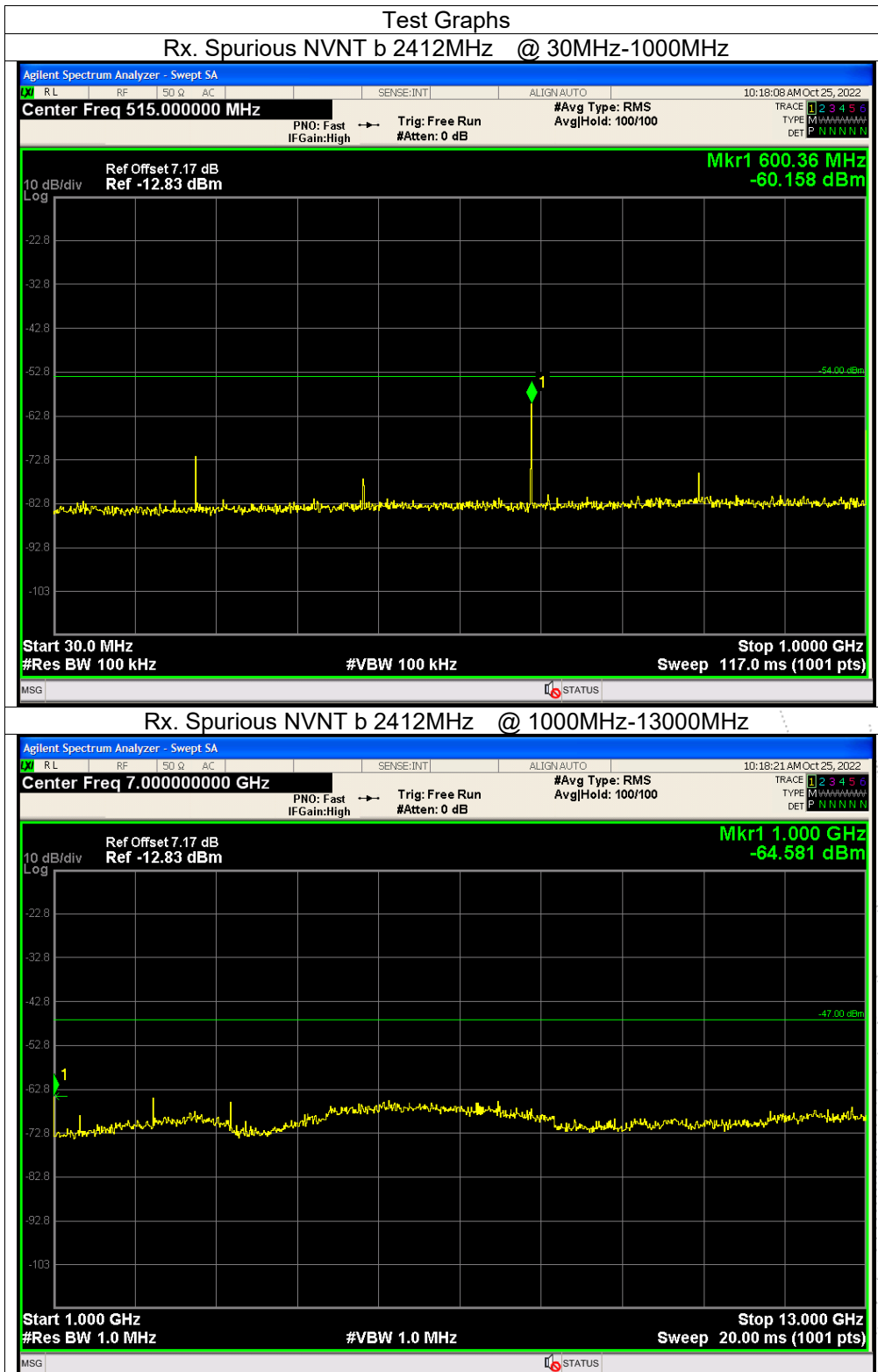

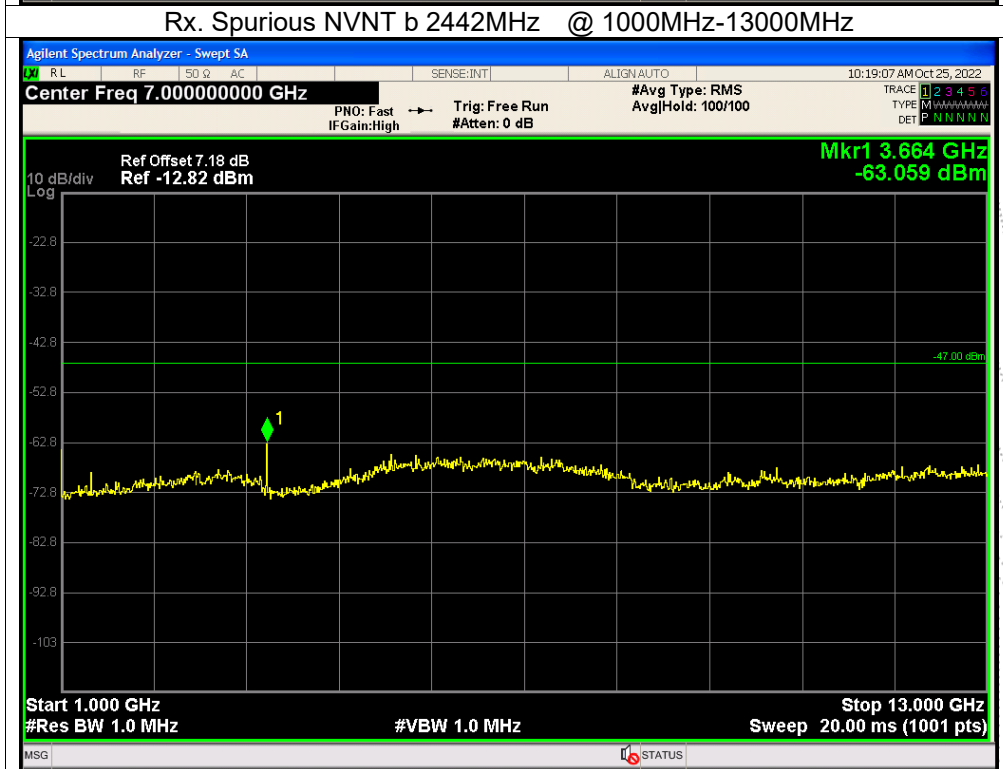
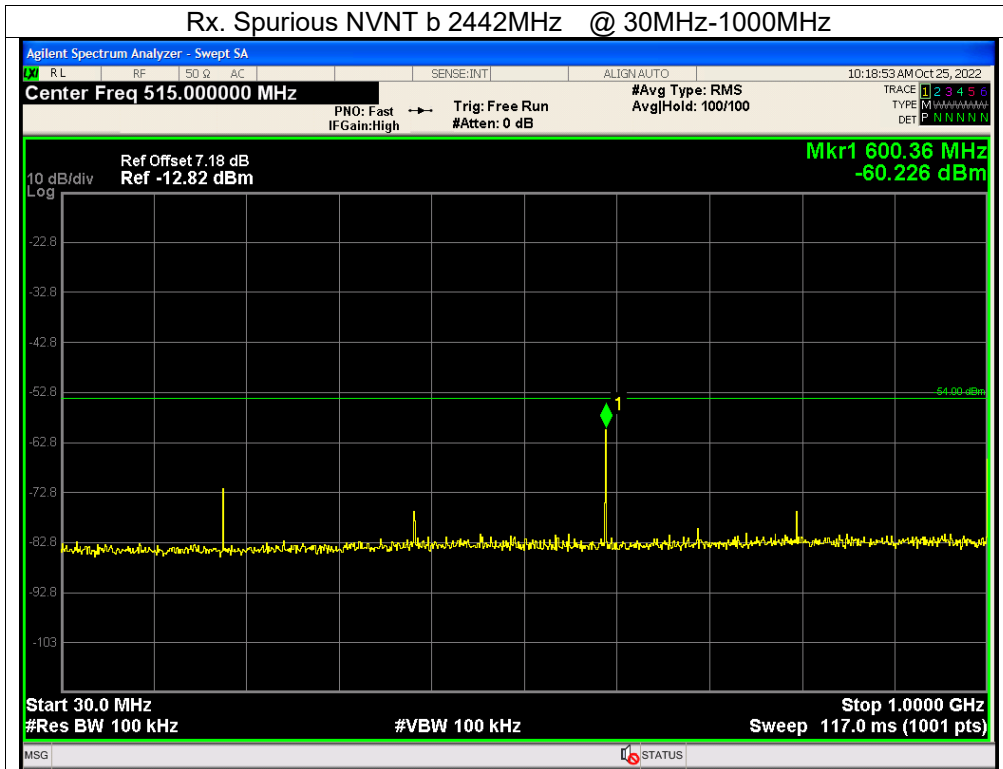

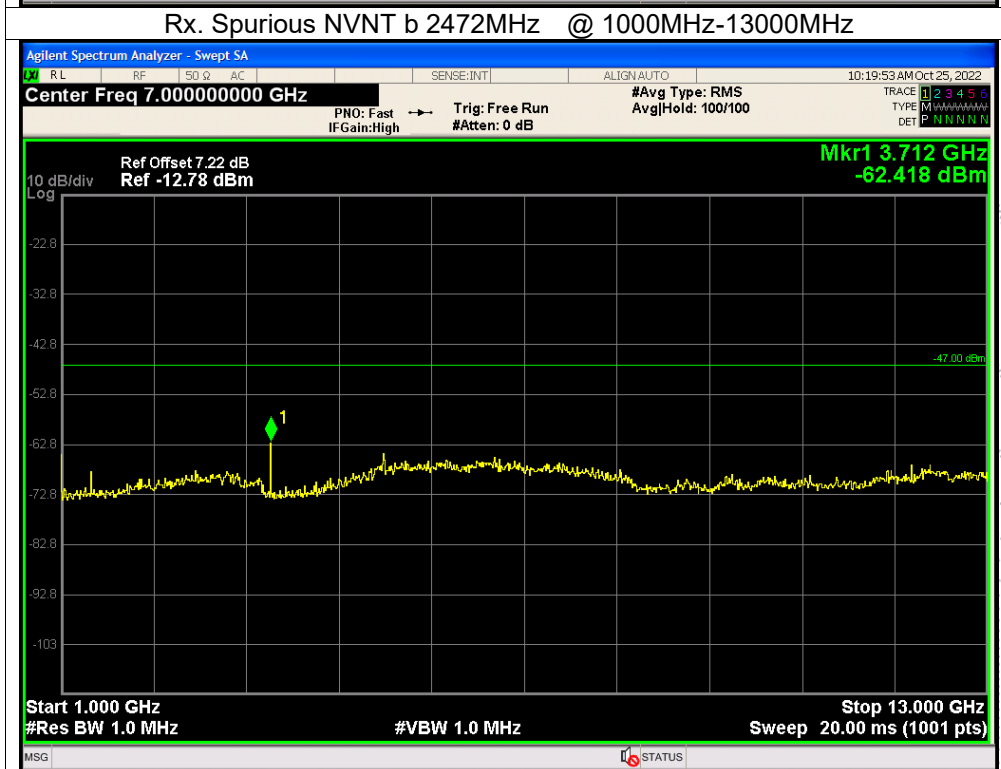
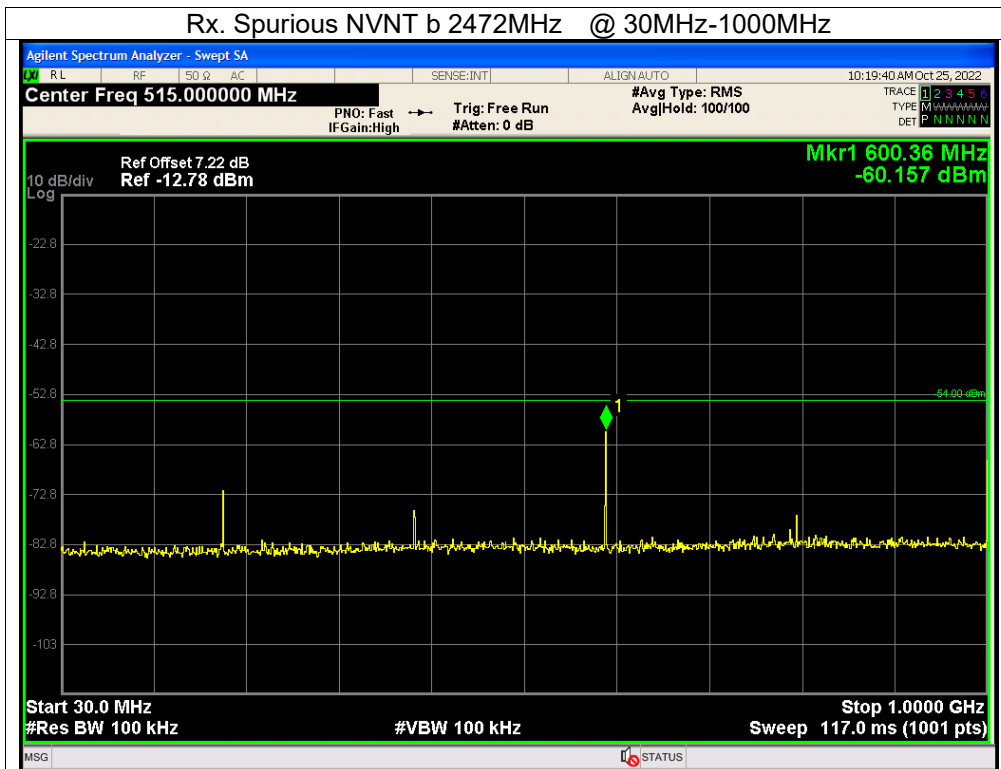

12. Transmission Antenna Gain (EIRP Antenna Power) Measurement

12.1 Block Diagram Of Test Setup

For EUT radiation measurement

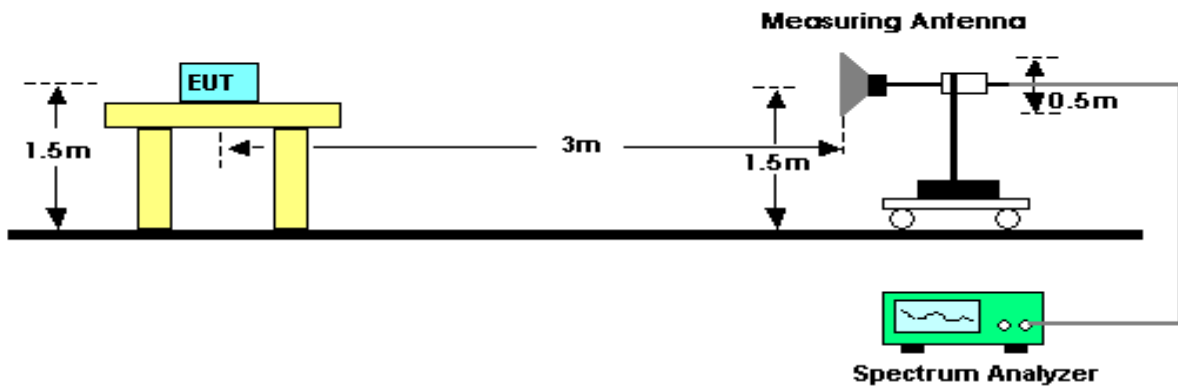

For standard antenna measurement

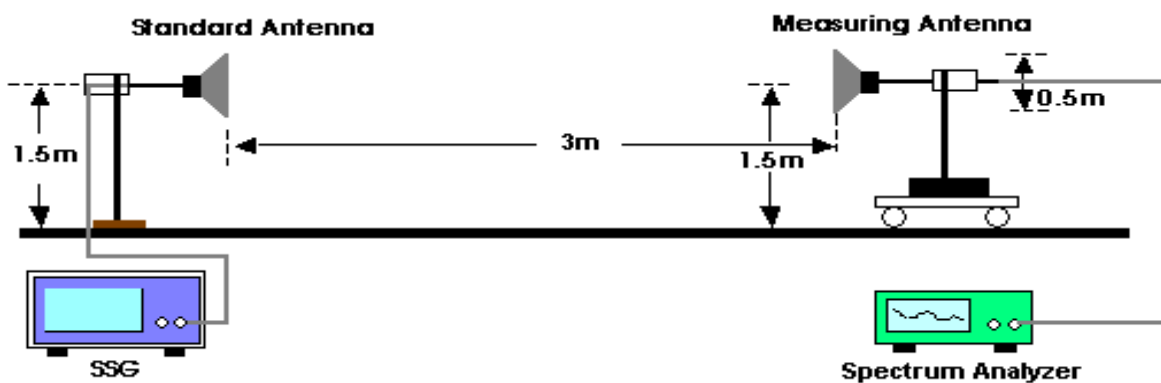

12.2 Limit

Modulation	Frequency band	Antenna power	Max EIRP	
			Non-directional	Beam directional ^{Note1}
DS	2,400-2,483.5MHz	10mW/MHz	12.14dBm/MHz	22.14dBm/MHz
OFDM1	2,400-2,483.5MHz	10mW/MHz	12.14dBm/MHz	22.14dBm/MHz
OFDM2	2,400-2,483.5MHz	5mW/MHz	9.14dBm/MHz	19.14dBm/MHz
FH,DS-FH, FH-OFDM	2,400-2,483.5MHz	3mW/MHz	6.91dBm/MHz	16.91dBm/MHz
	2,427-2,470.75MHz	10mW/MHz	12.14dBm/MHz	22.14dBm/MHz
Other than those above	2,400-2,483.5MHz	10mW	12.14dBm	22.14dBm

Note : OFDM 1 in the modulation method column indicates that the occupied frequency band width is 26 MHz or less, and OFDM 2 indicates the occupied frequency bandwidth exceeding 26 MHz and 38 MHz or less.

12.3 Measuring Instruments And Setting

Please refer to section 5 in this report. The following table is the setting of spectrum analyzer.

Spectrum Parameter	Setting
Attenuation	Auto
RB/VB	1 MHz
Detector	Peak
Trace	Max Hold
Sweep Time	Auto

12.4 Test Procedure

1. Set EUT and measuring antenna at the same height and roughly facing each other.
2. Move the measuring antenna height up and down within ± 50 cm of EUT height and swing it to find the maximum output of the measuring antenna. The output level at the spectrum analyzer is read as "E".
3. Remove the EUT from the turn table and put the replacing antenna facing to measuring antenna at same height. Set the standard signal generator (SSG) at same frequency and transmit on then receive the signal
4. Swing the replacing antenna give a maximum receiving level.
5. Move the measuring antenna height up and down within ± 50 cm of replacing antenna height and swing it to find the maximum receiving level.
6. Set SSG output power at Pt to give the equivalent output level of "E" or calculate Pt with SSG output which gives the nearest of "E" and difference (± 1 dB). Record the Pt.
7. Calculate EIRP by the formula below $EIRP = G_t - L + P_t$.
 Gt: gain of replacing antenna (dBi)
 L: feeder loss between SSG and replacing antenna
 Pt: Output power of the SSG
8. If the antenna for the EUT has circular polarization, sum of V-field and H-field will be result if measuring antenna is linear polarization.

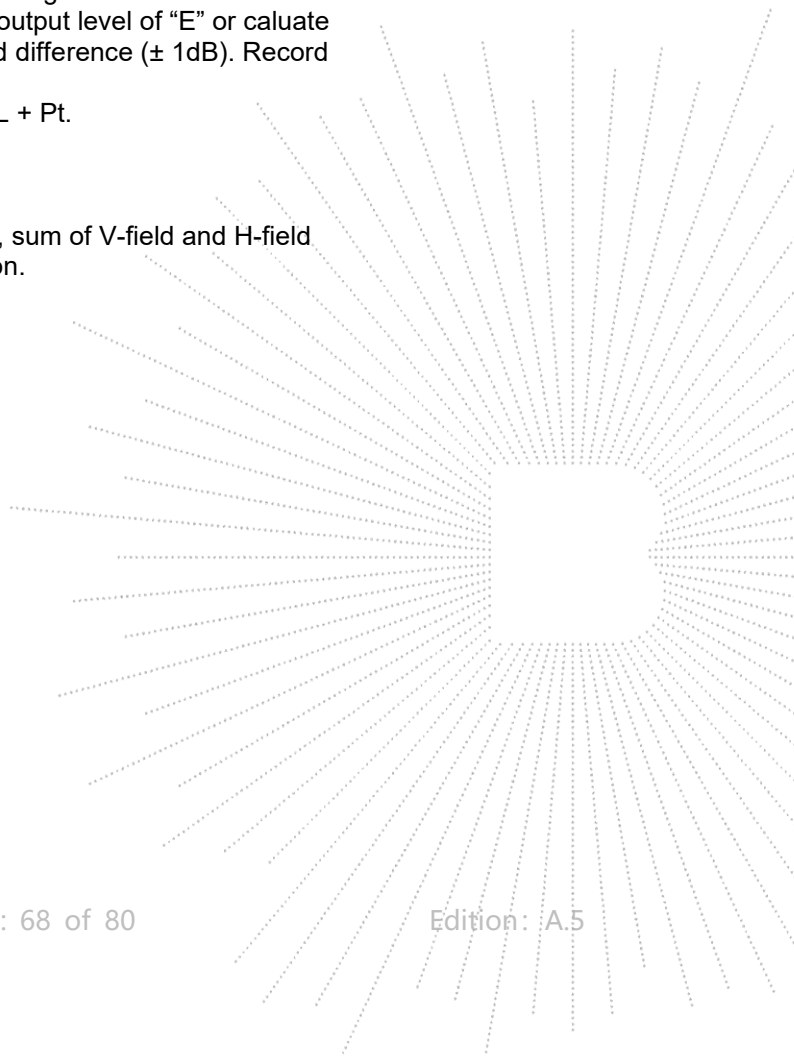

12.5 Test Result

Test voltage (V)	Mode	Channel (MHz)	Antenna Power (dBm/MHz)	ANT (dBi)	EIRP (dBm/MHz)	Limit (dBm/MHz)
DC 5V	802.11b	2412	4.622	-7.23	-2.608	12.14
		2442	4.494	-7.23	-2.736	
		2472	4.114	-7.23	-3.116	
	802.11g	2412	3.181	-7.23	-4.049	
		2442	3.973	-7.23	-3.257	
		2472	2.684	-7.23	-4.546	
	802.11n (HT20)	2412	2.502	-7.23	-4.728	
		2442	2.676	-7.23	-4.554	
		2472	1.528	-7.23	-5.702	

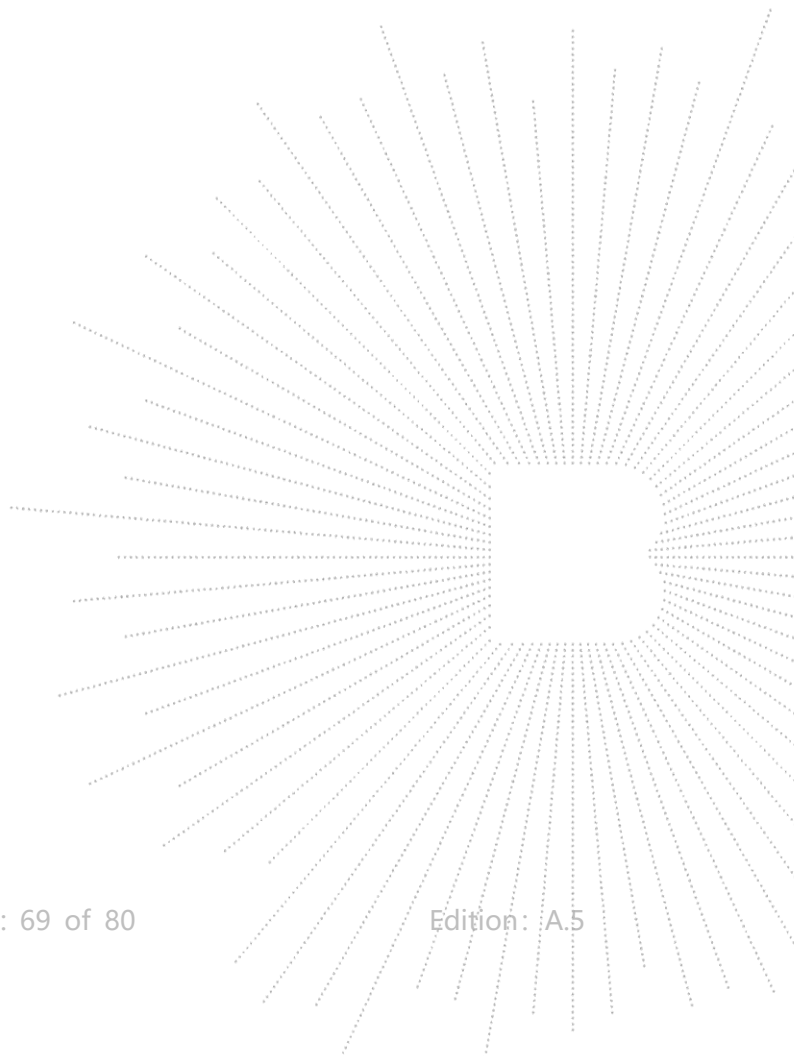

13. Transmission Radiation Angle Width (3db Beamwidth) Measurement

13.1 Block Diagram Of Test Setup

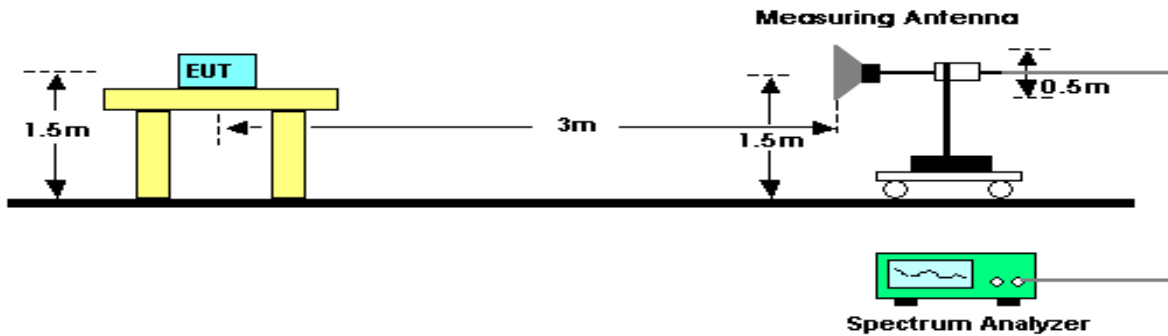

13.2 Limit

Item	Limits
3dB antenna beam width	$360/A$ (If $A < 1$; then $A = 1$) $A = \{ \text{EIRP Power [mW]} / 16.36 \text{ for DS, OFDM} \}$ or $A = \{ \text{EIRP Power [mW]} / 4.9 \text{ for FH} \}$
Note ₁ : $A = \text{E.I.R.P.} / (2.14\text{dBi} + \text{"Antenna Power (limit)" of each modulation method (*3mW/MHz, 10mW/MHz, etc.)}$) Note ₂ : This test item is not applied for radio equipment with equivalent isotropic radiation power lower than 12.14dBm/MHz, but Antenna Power(Conducted) limit is 10 mW/MHz (10 dBm/MHz), So the test item will not be applied to the transmission antenna which has a gain of 2.14dBi or less	

13.3 Measuring Instruments And Setting

Spectrum Parameter	Setting
Attenuation	Auto
Span Frequency	0 MHz
RB	1 MHz
VB	1 kHz
Detector	Peak
Trace	Max Hold
Sweep Time	Auto

13.4 Test Procedure

1. Set EUT and measuring antenna at the same height and roughly facing each other.
2. Set spectrum analyzer with condition in section 4.7.2 and tune reference level to observe receiving signal position.
3. Rotate directions of the EUT horizontally and vertically to find the maximum receiving power.
4. Move the measuring antenna height up and down within $\pm 50\text{cm}$ of EUT height and swing it to find the maximum output of measuring antenna. The output level at the spectrum analyzer is read as "E"
5. Calculate permitted radiation angle in horizontal and vertical using EIRP measured in another test method.
6. Calculate 3dB antenna beam width by the formula below $360/A$ (If $A < 1$; then $A=1$).
 $A = \{\text{EIRP Power [mW]} / 16.36 \text{ for DS, OFDM}\}$ or
 $A = \{\text{EIRP Power [mW]} / 4.9 \text{ for FH}\}$

13.5 Test Result

N/A

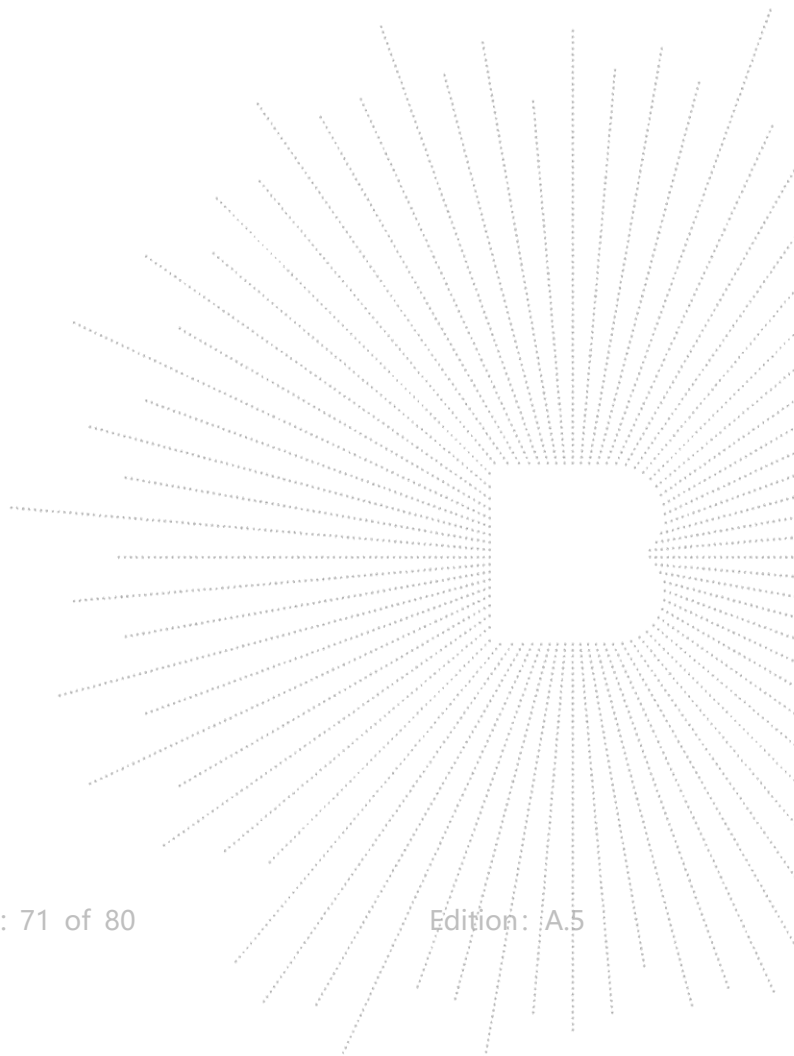

14. Radio Interference Prevention Capability Measurement

14.1 Block Diagram Of Test Setup

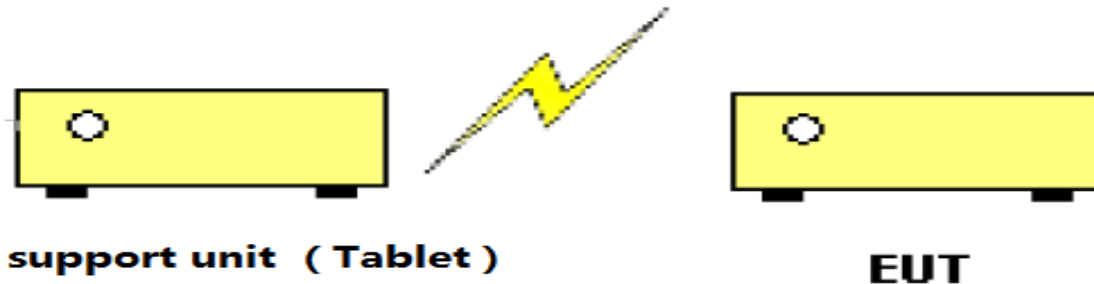

14.2 Limit

Item	Limits
Identification code	≥ 48 bits

14.3 Measuring Instruments And Setting

Item	Limits
MAC IP List	MAC Scan

14.4 Test Procedure

1. In the case that the EUT has the function of automatically transmitting the identification code:
 - a. Transmit the predetermined identification codes form EUT. b. Check the transmitted identification codes with the demodulator.
2. In the case of receiving the identification ocde:
 - a. Transmit the predetermined identification codes form the counterpart.
 - b . Check if communication is normal.
 - c. Transmit the signals other than predetermined ID codes form the counterpart.
 - d. check if the EUT stops the transmission, or if it displays that idnetification codes are different from the predetermined ones.

14.5 Test Result

Test result:	CONFORM
--------------	---------

MAC: 32:76:16:43:ed:25

15. Carrier Sense Capability Measurement

15.1 Block Diagram Of Test Setup

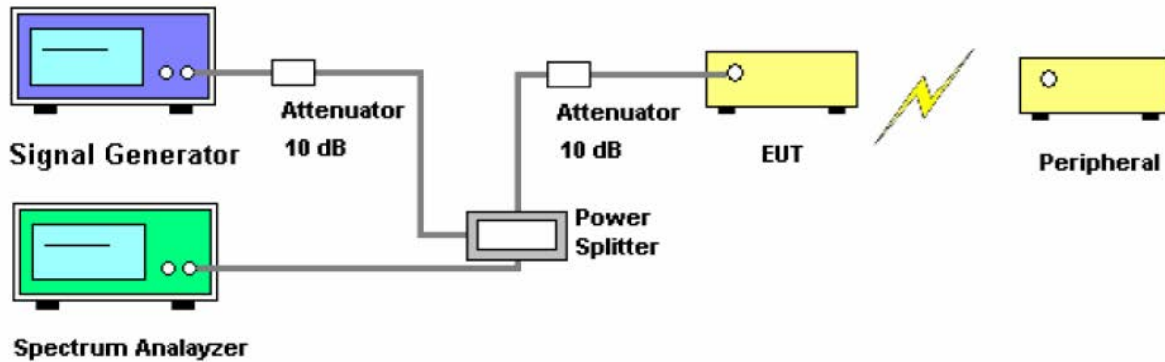

15.2 Limit

EUT stop RF transmission signal after carrier inject to EUT

15.3 Test Procedure

1. SG adjusted the frequency as same as the EUT transmitted signal and emitted the absence of modulation from SG and power level is $(on\ 22.79+G-20*\log(f)\text{dBm})$ (G is the antenna gain, f is the test frequency).
2. turn off the RF signal of the SG.
3. EUT have transmitted the maximum modulation signal and fixed channelize.
4. Setting of SA :RBW/VBW=1MHz/1MHz, Span=50MHz, Sweep time=auto, Sweep mode=continuous, Detect mode=positive peak
5. SG RF signal on.
6. EUT shall be stop the transmitted any signal and SG RF signal off, the EUT will be continuous transmitted signal.

15.4 Test Result

Note: For this test just evaluate the mode which bandwidth $\geq 26\text{MHz}$.

Result:N/A

16. Duty Cycle Of Test Signal

16.1 Standard Requirement

Pre-analysis Check: While conducting average power measurement, duty cycle of each mode shall be checked to ensure its duty cycle in order to compensate for the loss due to insufficient ratio of duty cycle. All duty cycle is pre-scanned, and result as obtained below shows only the most representative ones where duty cycle is conducted as the given transmission with given virtual operation that expresses the percentage

16.2 Formula

Duty Cycle = $T_{on} / (T_{on} + T_{off})$

16.3 Test Procedure

1. Set span = Zero
2. RBW = 8MHz
3. VBW = 8MHz,
4. Detector = Peak

16.4 Test Result

	Duty Cycle	Duty Fator (dB)
802.11b	1	0
802.11g	1	0
802.11n(HT20)	1	0

802.11b

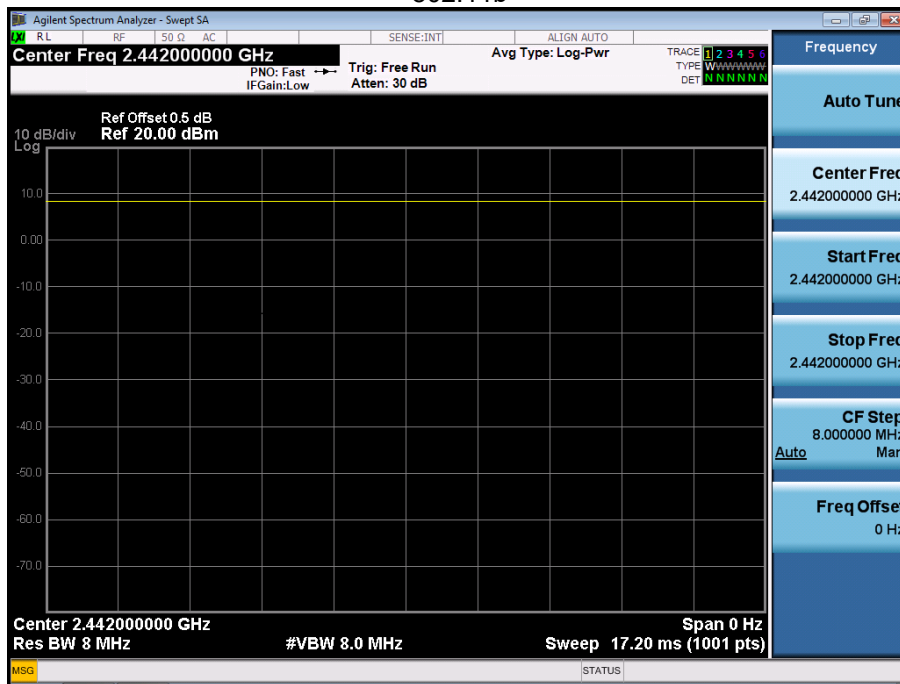

802.11g

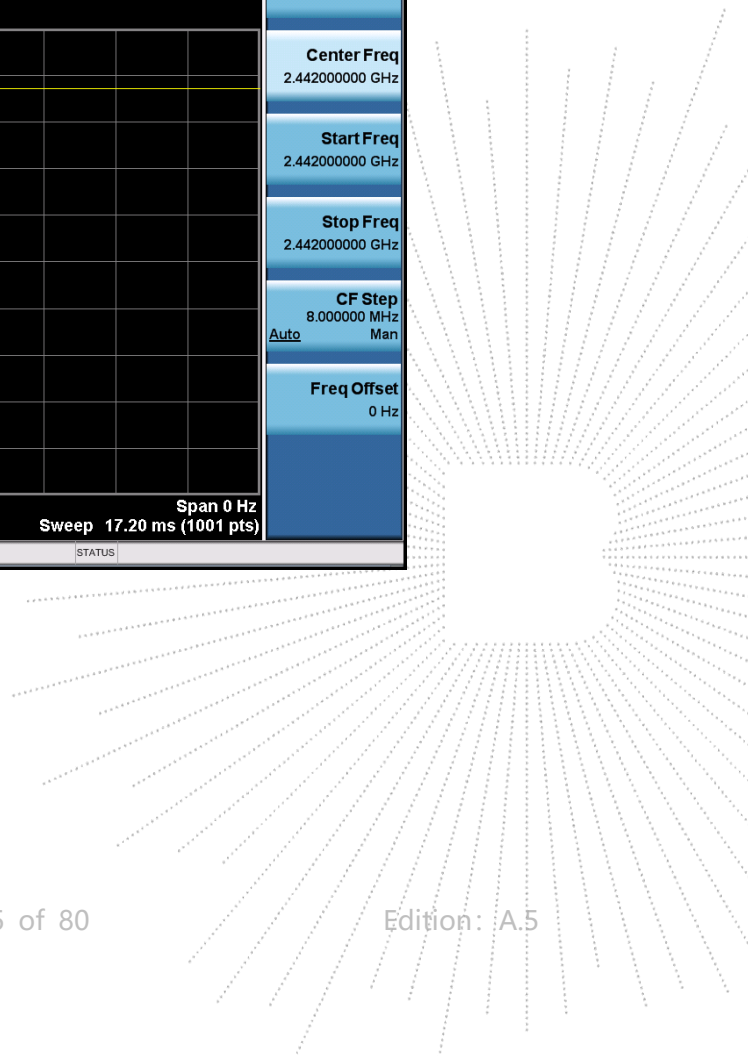
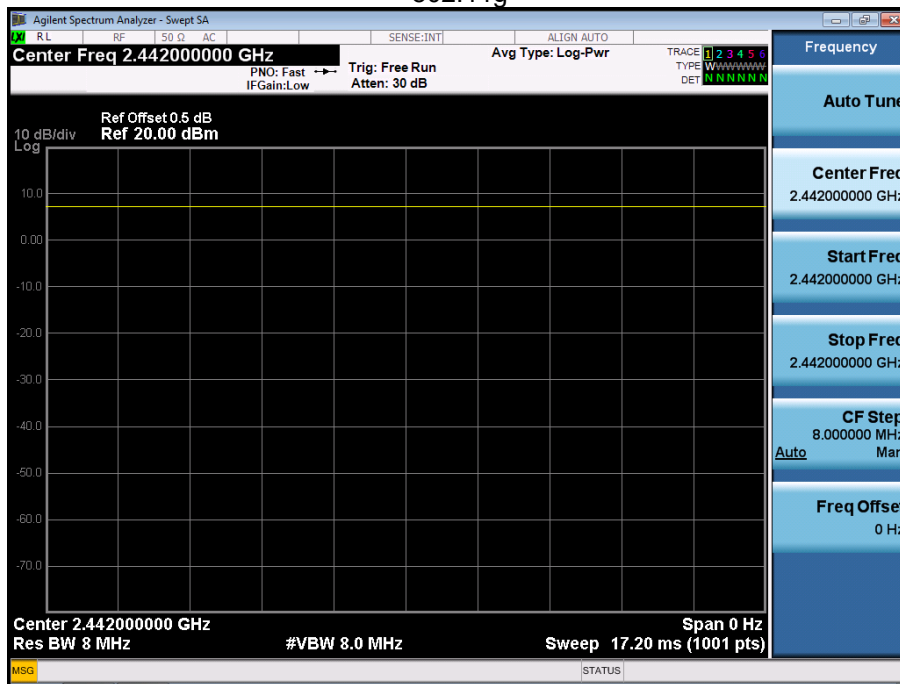

802.11n(HT20)

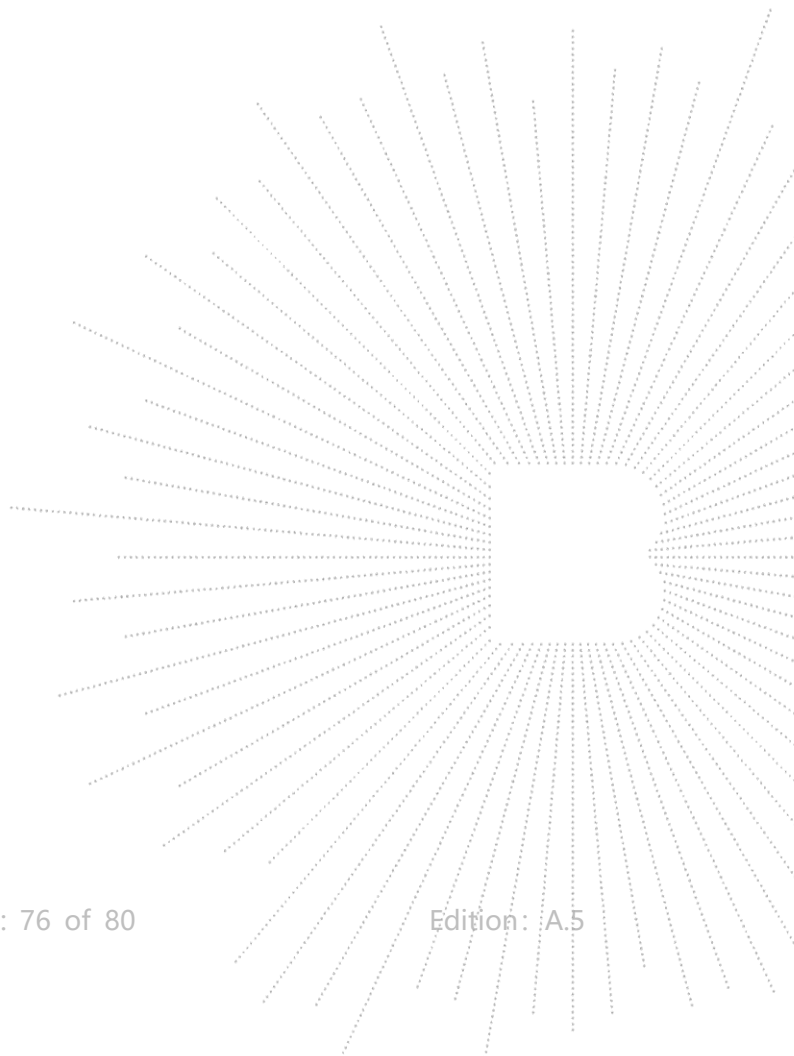
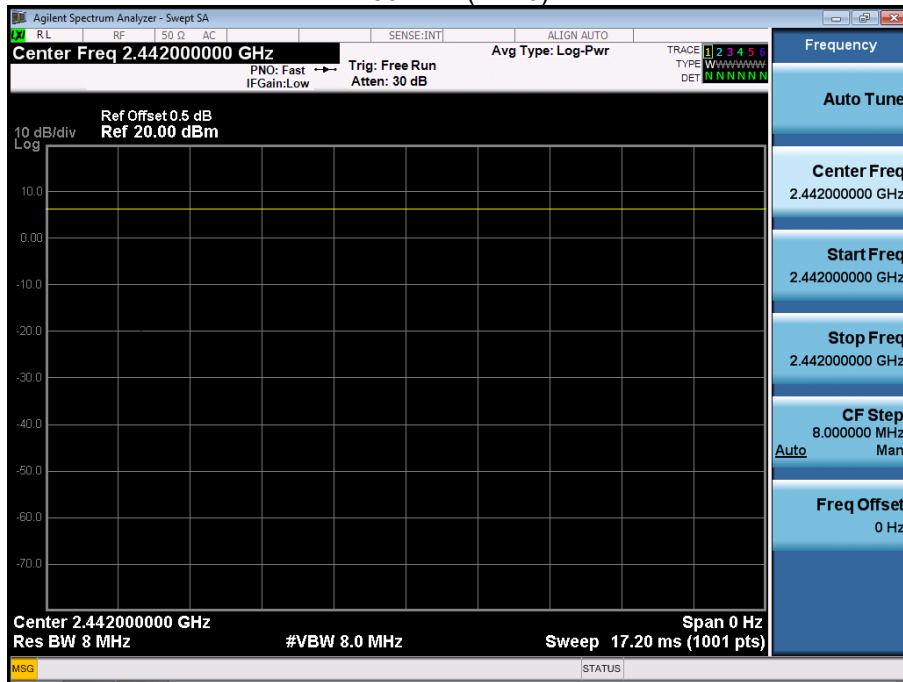

17. EUT Photographs

EUT Photo 1

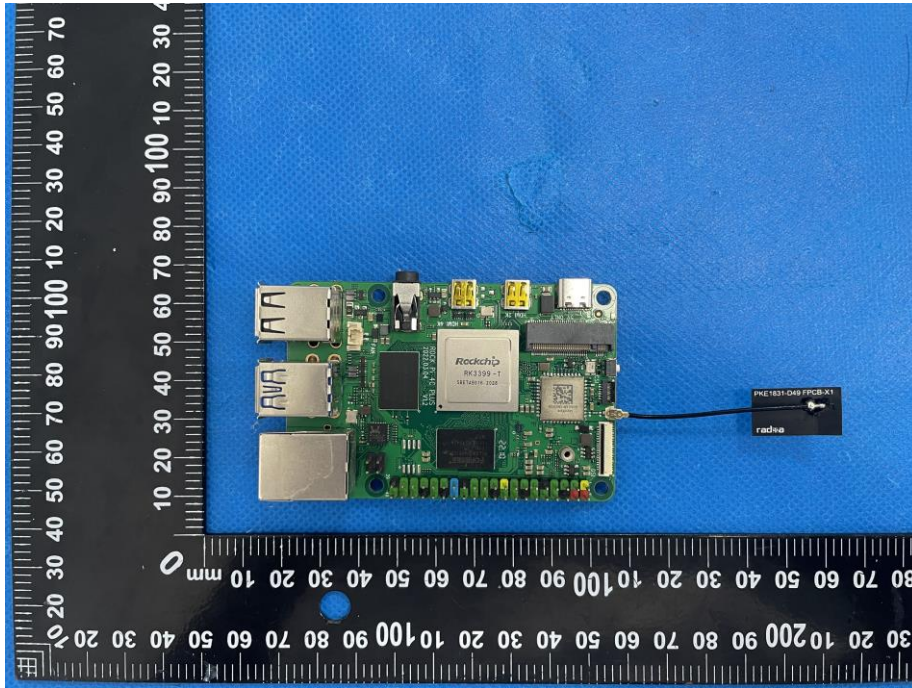

EUT Photo 2

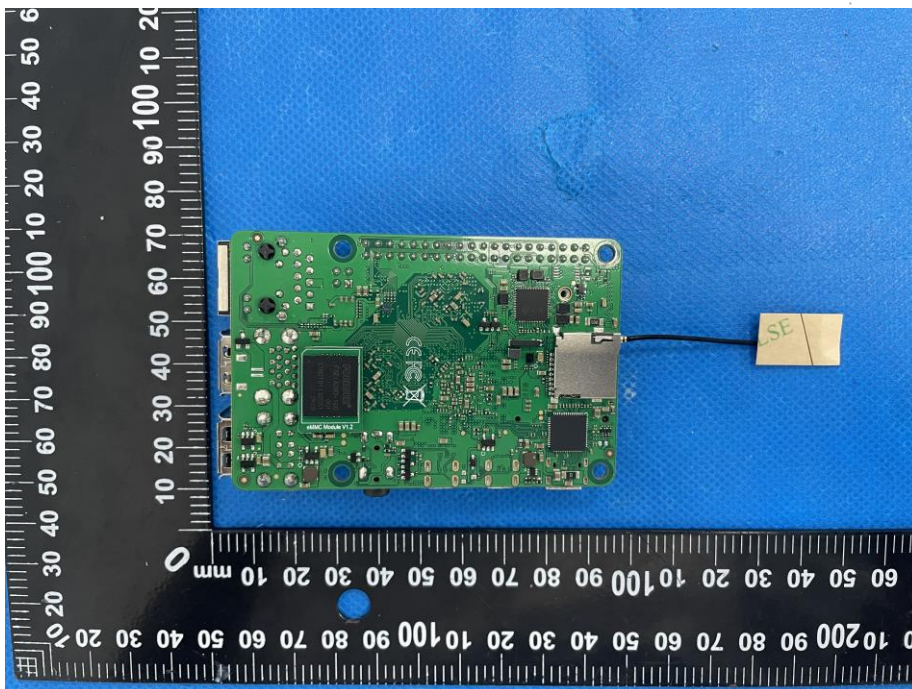

EUT Photo 3

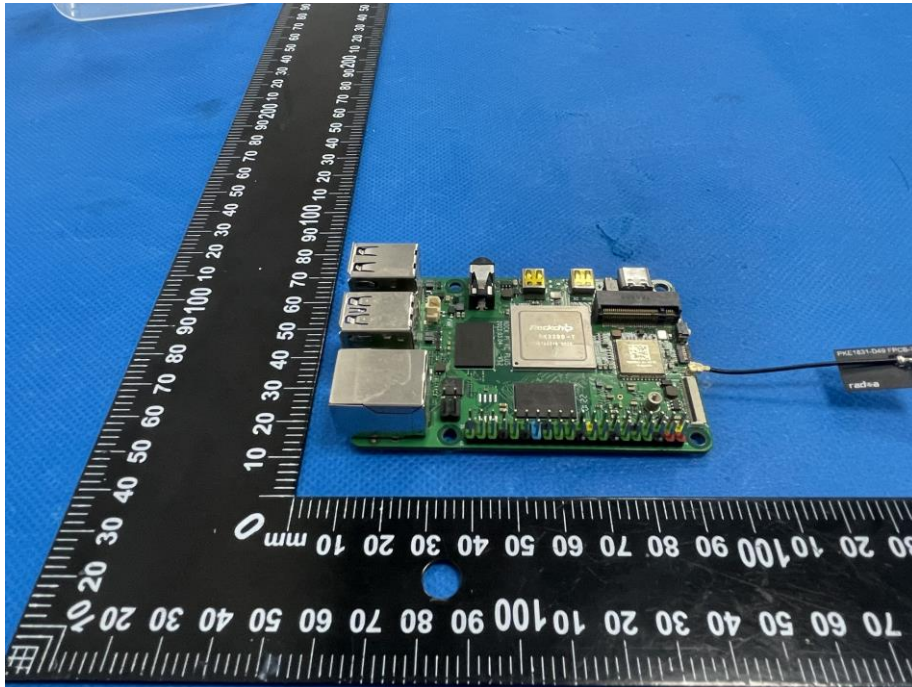

EUT Photo 4

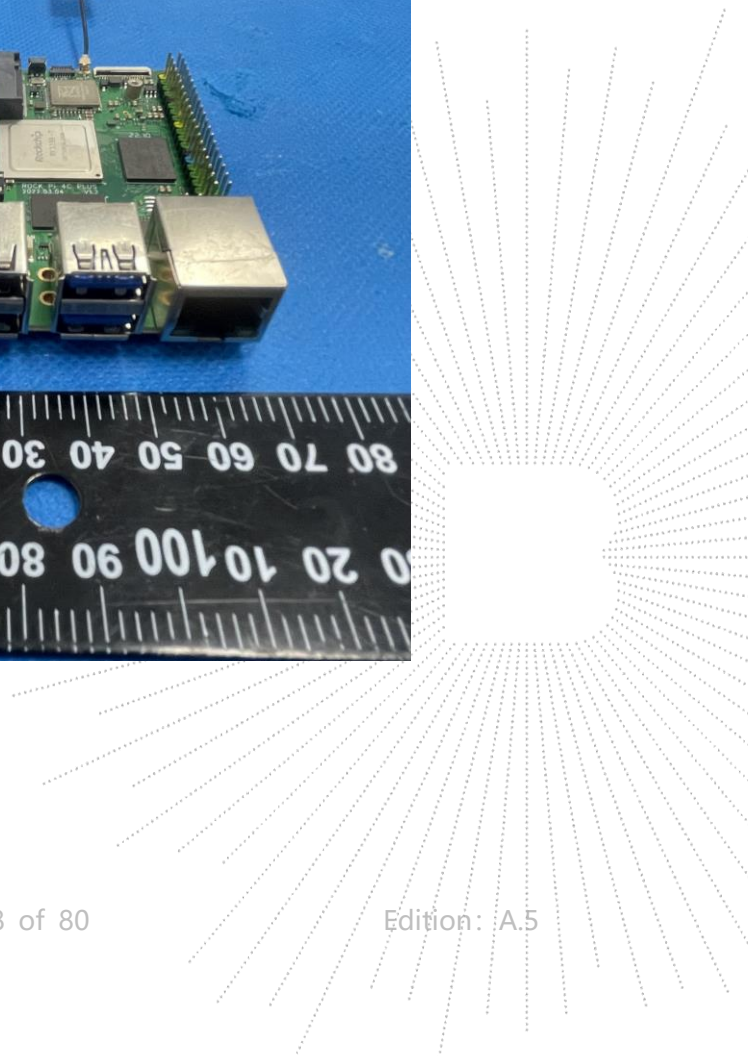
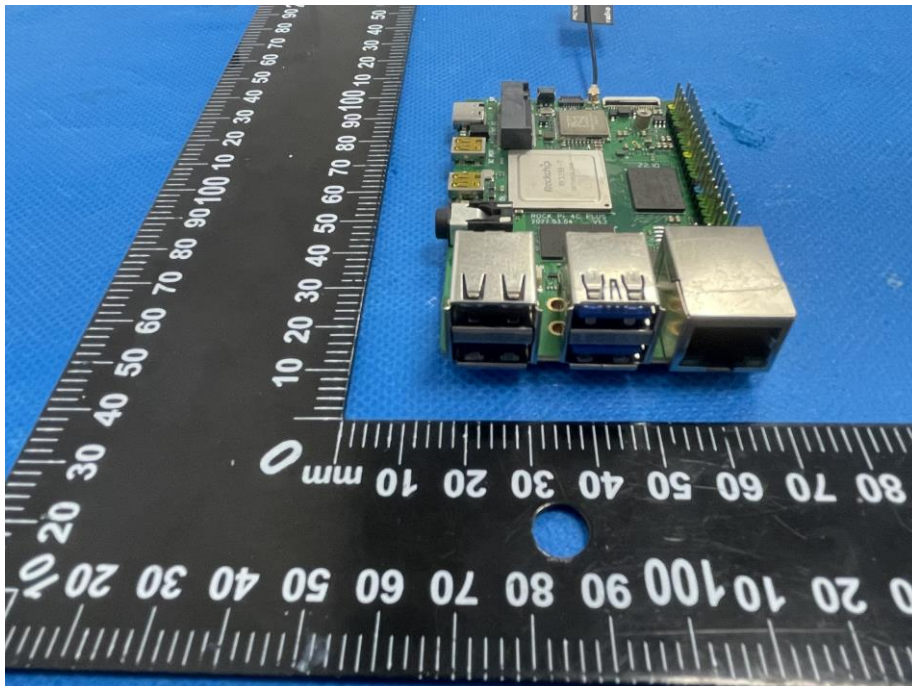

18. EUT Test Setup Photographs

Measurement Photos

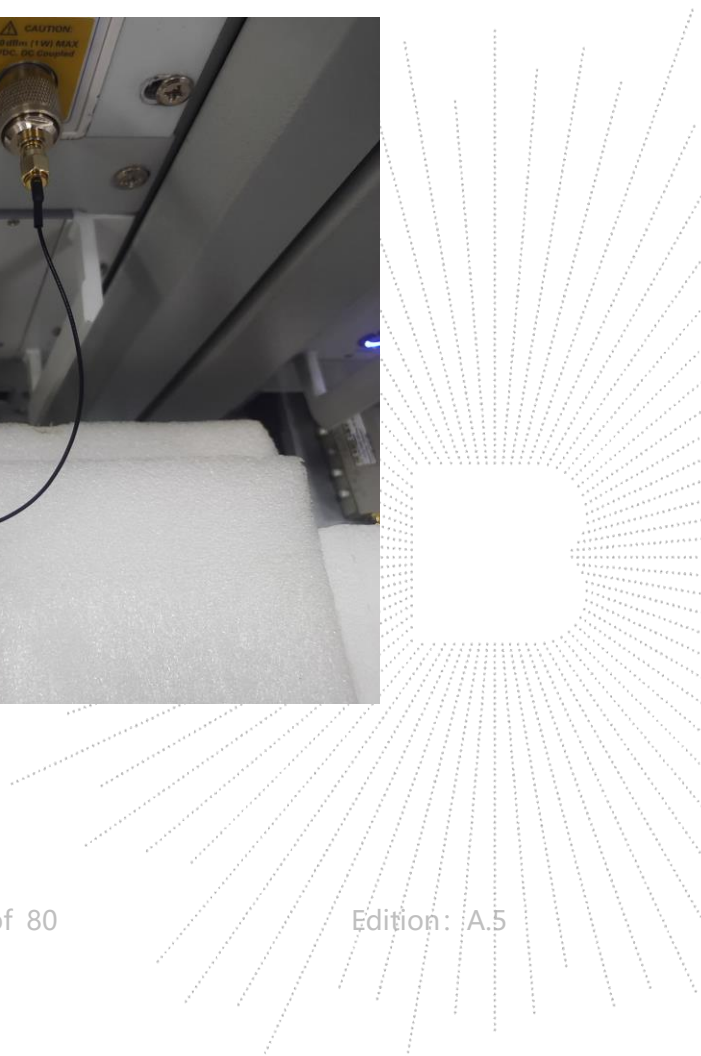
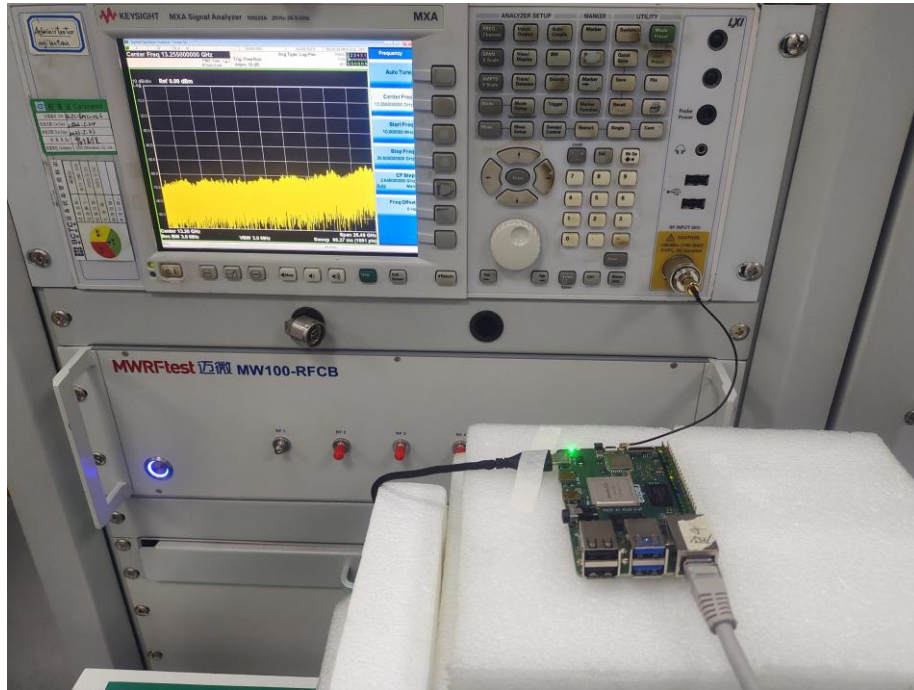

STATEMENT

1. The equipment lists are traceable to the national reference standards.
2. The test report can not be partially copied unless prior written approval is issued from our lab.
3. The test report is invalid without the "special seal for inspection and testing".
4. The test report is invalid without the signature of the approver.
5. The test process and test result is only related to the Unit Under Test.
6. Sample information is provided by the client and the laboratory is not responsible for its authenticity.
7. The test report without CMA mark is only used for scientific research, teaching, enterprise product development and internal quality control purposes.
8. The quality system of our laboratory is in accordance with ISO/IEC17025.
9. If there is any objection to this test report, the client should inform issuing laboratory within 15 days from the date of receiving test report.

Address:

1-2/F., Building B, Pengzhou Industrial Park, No.158, Fuyuan 1st Road, Zhancheng, Fuhai Subdistrict, Bao'an District, Shenzhen, Guangdong, China

TEL: 400-788-9558

P.C.: 518103

FAX: 0755-33229357

Website: <http://www.chnbctc.com>

E-Mail: bctc@bctc-lab.com.cn

***** END *****