

TEST REPORT

Report No.: BCTC2210401068-4E

Applicant: OKdo Technology Limited

Product Name: ROCK Pi 4/ROCK 4

Model/Type Ref.: ROCK 4C Plus

Tested Date: 2022-10-21 to 2022-12-06

Issued Date: 2022-12-06

Shenzhen BCTC Testing Co., Ltd.



Product Name: ROCK 4C Plus
ROCK Pi 4C Plus, ROCK Pi 4C Pro, ROCK Pi 4C Max, ROCK 4C,
ROCK 4C Pro, ROCK 4C Max

Trademark: N/A

Model/Type Ref.: ROCK 4C Plus

Prepared For: OKdo Technology Limited

Address: 5th Floor, 2 Pancras Square, King's Cross, London N1C 4AG, United Kingdom

Manufacturer: OKdo Technology Limited

Address: 5th Floor, 2 Pancras Square, King's Cross, London N1C 4AG, United Kingdom

Prepared By: Shenzhen BCTC Testing Co., Ltd.

Address: 1-2/F., Building B, Pengzhou Industrial Park, No.158, Fuyuan 1st Road, Zhancheng,
Fuhai Subdistrict, Bao'an District, Shenzhen, Guangdong, China

Sample Received Date: 2022-10-21

Sample tested Date: 2022-10-21 to 2022-12-06

Issue Date: 2022-12-06

Report No.: BCTC2210401068-4E

Test Standards: ARIB STD-T71 Ver.6.1
Article2 Paragraph 1, item 19-3

Test Results: PASS

Remark: This is JAPAN RADIO test report.

Tested by:

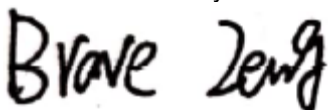

Brave Zeng/ Project Handler

Approved by:



Zero Zhou/Reviewer

The test report is effective only with both signature and specialized stamp. This result(s) shown in this report refer only to the sample(s) tested. Without written approval of Shenzhen BCTC Testing Co., Ltd, this report can't be reproduced except in full. The tested sample(s) and the sample information are provided by the client.

Table Of Content

Test Report Declaration	Page
1. Version	5
2. Test Summary	6
3. Measurement Uncertainty	7
4. Product Information And Test Setup	8
4.1 Product Information.....	8
4.2 Block Diagram Parameters Of Text Software Setting	9
4.3 Description Of Support Units (Conducted Mode)	9
4.4 Channel List.....	9
4.5 Test Mode	10
4.6 Test Conditions	10
4.7 Table Of Parameters Of Test Software Setting	11
5. Test Facility And Test Instrument Used.....	12
5.1 Test Facility.....	12
5.2 Test Instrument Used.....	12
6. RF Shielding Method.....	13
7. Frequency Error	14
7.1 Block Diagram Of Test Setup.....	14
7.2 Limit	14
7.3 Measuring Instruments And Setting	14
7.4 Test Procedure	14
7.5 Test Result.....	15
8. Antenna Power.....	19
8.1 Block Diagram Of Test Setup.....	19
8.2 Limit	19
8.3 Measuring Instruments And Setting	19
8.4 Test Procedure	20
8.5 Test Result.....	21
9. Occupied Bandwidth	23
9.1 Block Diagram Of Test Setup.....	23
9.2 Limit	23
9.3 Test Procedure	23
9.4 Test Result.....	24
10. Unwanted Emission Intensity Measurement.....	32
10.1 Block Diagram Of Test Setup.....	32
10.2 Limit	32
10.3 Measuring Instruments And Setting	32
10.4 Test Procedure	32
10.5 Test Result.....	33
11. Secondary Radiated Emissions Measurement.....	75
11.1 Block Diagram Of Test Setup.....	75
11.2 Limit	75
11.3 Measuring Instruments And Setting	75
11.4 Test Procedure	75

11.5	Test Result.....	76
12.	Transmitter Burst Length Measurement.....	82
12.1	Block Diagram Of Test Setup.....	82
12.2	Limit.....	82
12.3	Measuring Instruments And Setting.....	82
12.4	Test Result.....	83
13.	Interference Prevention Function Measurement.....	92
14.	Carrier Sense Capability Measurement.....	93
14.1	Block Diagram Of Test Setup.....	93
14.2	Limit.....	93
14.3	Test Procedure.....	94
14.5	Test Result.....	94
15.	Adjacent Channel Emitted Power Measurement.....	95
15.1	Block Diagram Of Test Setup.....	95
15.2	Limit.....	95
15.3	Measuring Instruments And Setting.....	95
15.4	Test Result.....	96
16.	EUT Photographs.....	103
17.	EUT Test Setup Photographs.....	105

(Note: N/A Means Not Applicable)

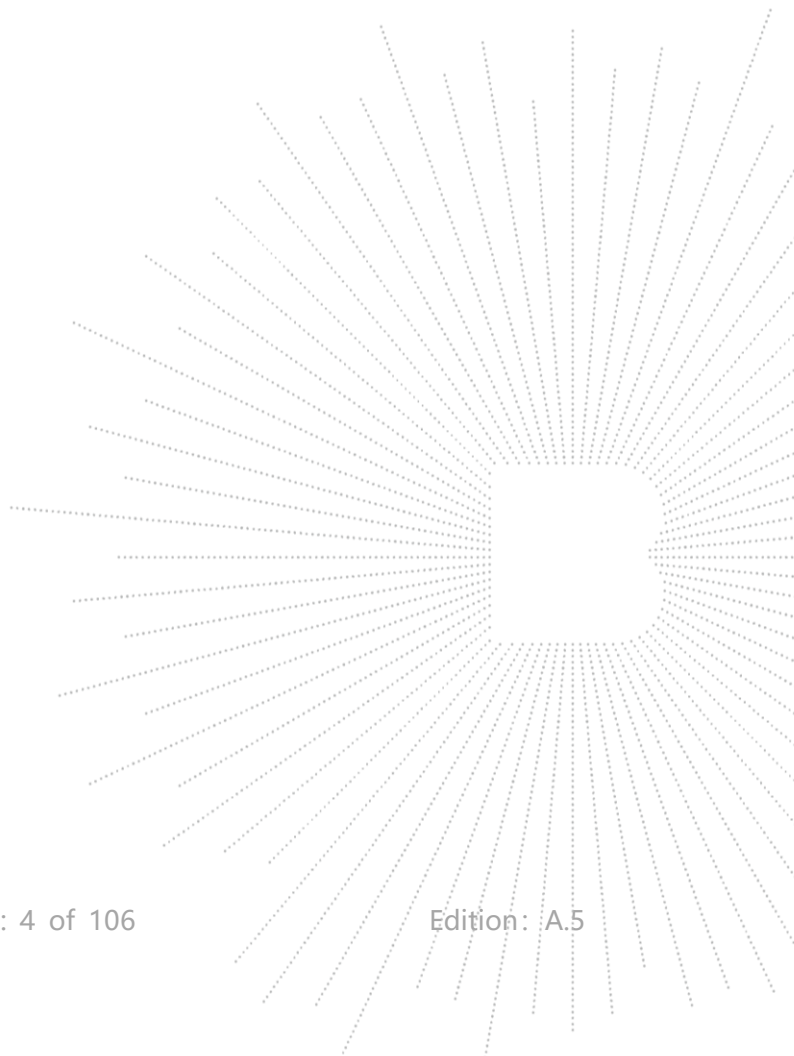

1. Version

Report No.	Issue Date	Description	Approved
BCTC2210401068-4E	2022-12-06	Original	Valid

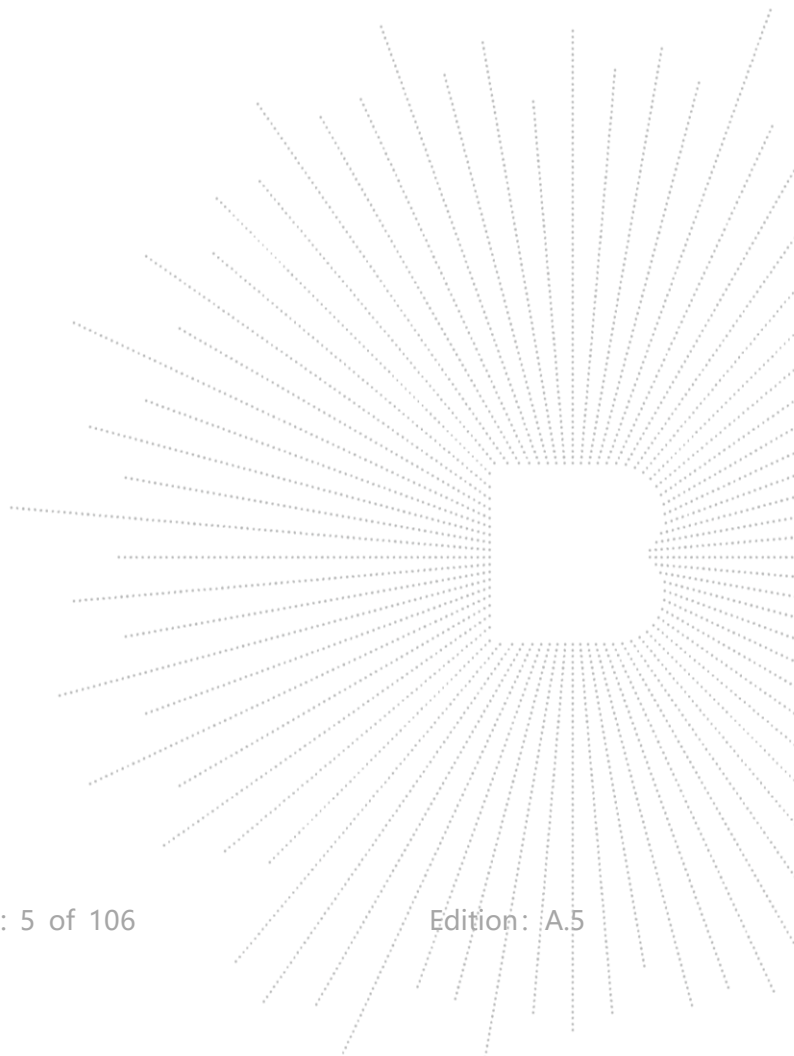

2. Test Summary

Test procedures according to the technical standards:

Article 49-20	
Description of Test	Result
Frequency Error	Complies
Occupied Bandwidth (99%)	Complies
Unwanted Emission Intensity	Complies
Antenna Power and Tolerance	Complies
Secondary Radiated Emissions	Complies
Transmitter Burst Length	Complies
Interference Prevention Function	Complies
Carrier Sense Capability	Complies
Adjacent Channel Emitted Power	Complies
Out-Band Leakage Power	Complies
Construction Protection Confirmation	Complies

NOTE:

- (1) MIC Notice No.88 Appendix No.45
- (2) MIC Ordinance Regulating Radio Equipment Section 4.17 of Article 49.20

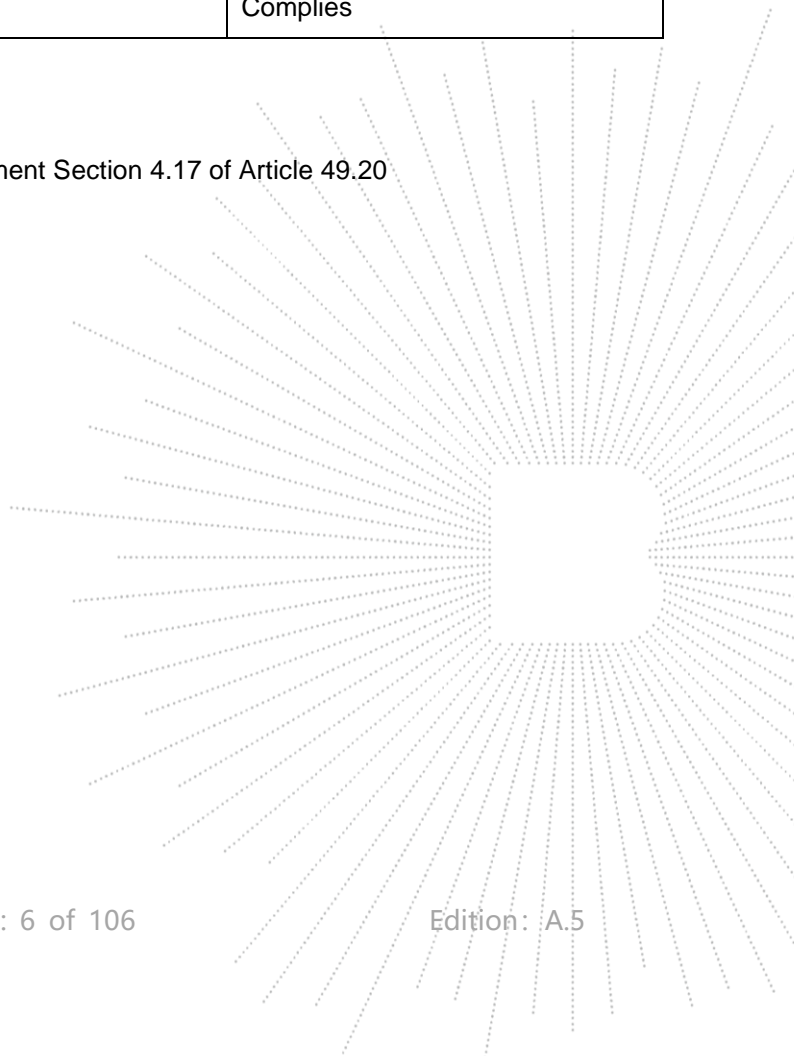

3. Measurement Uncertainty

The reported uncertainty of measurement $y \pm U$, where expanded uncertainty U is based on a standard uncertainty multiplied by a coverage factor of $k=2$, providing a level of confidence of approximately 95 %.

No.	Item	Uncertainty
1	Conducted Emission Test	$\pm 3.2\text{dB}$
2	Radiated Emission Test	$\pm 4.7\text{dB}$
3	RF power,conducted	$\pm 0.16\text{dB}$
4	Spurious emissions,conducted	$\pm 0.21\text{dB}$
5	All emissions,radiated(<1G)	$\pm 4.68\text{dB}$
6	All emissions,radiated(>1G)	$\pm 5.0\text{dB}$
7	frequency error ppm	$\pm 0.5\text{ppm}$

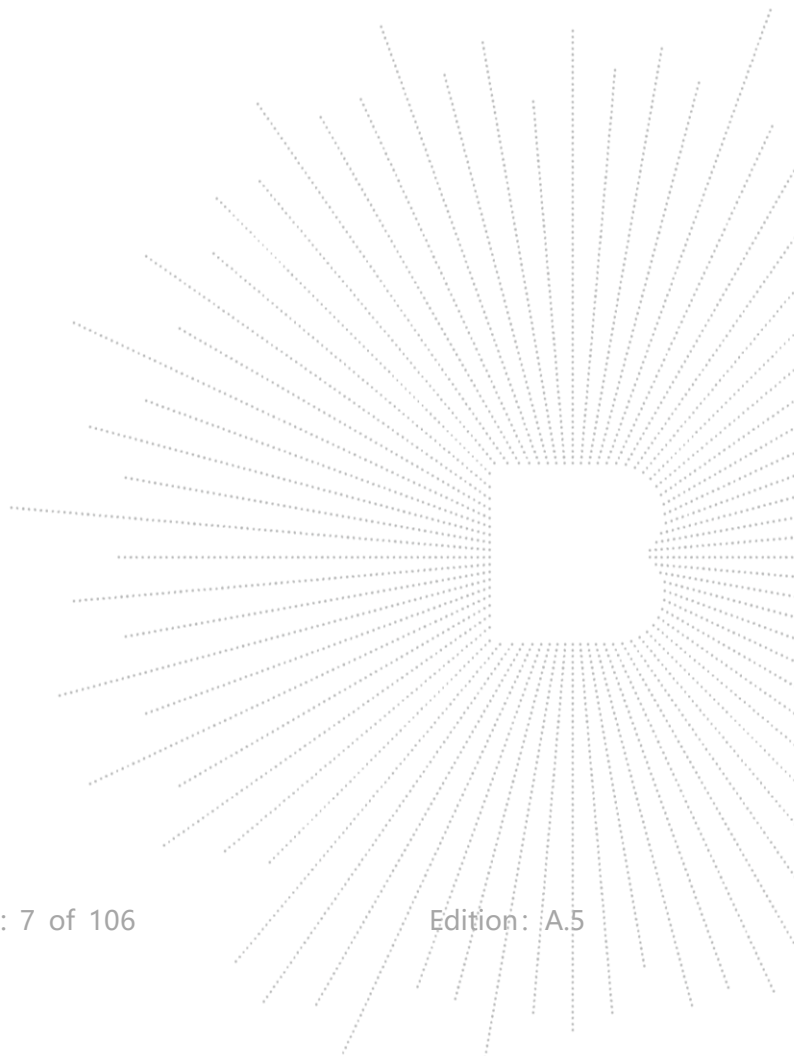

4. Product Information And Test Setup

4.1 Product Information

Model/Type Ref.:	ROCK 4C Plus ROCK Pi 4C Plus, ROCK Pi 4C Pro, ROCK Pi 4C Max, ROCK 4C, ROCK 4C Pro, ROCK 4C Max
Model differences:	All the model are the same circuit and RF module, except model names.
Hardware Version:	V1.0
Software Version:	V1.0
Wi-Fi Specification:	802.11a/n/ac(20MHz channel bandwidth) 802.11n/ac(40MHz channel bandwidth) 802.11ac(80MHz channel bandwidth)
Operation Frequency:	5180MHz-5240MHz for 802.11a/n(HT20)/ac20; 5190MHz-5230MHz for 802.11n(HT40)/ac40; 5210MHz for 802.11 ac80;
Rated RF Output Power Density	802.11a: 3mW/MHz ; 802.11n20: 3mW/MHz; 802.11 n40: 2mW/MHz; 802.11 ac20: 3mW/MHz; 802.11 ac40: 2mW/MHz; 802.11 ac80: 1mW/MHz;
Conducted Power Density	802.11a: 3.154 mW/MHz ; 802.11n20: 2.445 mW/MHz; 802.11 n40: 0.77 mW/MHz; 802.11 ac20: 2.665 mW/MHz; 802.11 ac40: 0.68 mW/MHz; 802.11 ac80: 0.396 mW/MHz;
Type of Modulation:	OFDM with BPSK/QPSK/16QAM/64QAM/256QAM for 802.11a/n/ac;
Data Rate	802.11a: 6,9,12,18,24,36,48,54Mbps; 802.11n(HT20/HT40):MCS0-MCS15; 802.11ac(VHT20): NSS1, MCS0-MCS8 802.11ac(VHT40/VHT80):NSS1, MCS0-MCS
Number Of Channel:	4 channels for 802.11a/n20 in the 5180-5240MHz band ; 2 channels for 802.11 n40 in the 5190-5230MHz band ; 1 channels for 802.11 ac80 in the 5210MHz band ;
Antenna installation:	FPC antenna
Antenna Gain:	4.10 dBi
Ratings:	DC 5V

4.2 Block Digram Parameters Of Text Software Setting

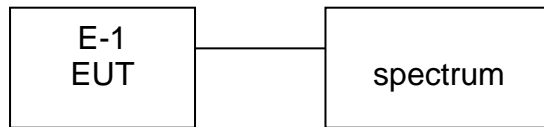

4.3 Description Of Support Units (Conducted Mode)

Item	Equipment	Mfr/Brand	Model/Type No.	Series No.	Note
E-1	ROCK Pi 4/ROCK 4	N/A	ROCK 4C Plus	N/A	EUT

Notes:

1. The support equipment was authorized by Declaration of Confirmation.
2. For detachable type I/O cable should be specified the length in cm in 『Length』 column
3. “YES” is means “shielded” “with core”; “NO” is means “unshielded” “without core”.

4.4 Channel List

802.11a/n/ac(20MHz) Frequency Channel			
Channel	Frequency (GHz)	Channel	Frequency (GHz)
36	5.180	44	5.220
40	5.200	48	5.240

802.11n/ac(40MHz) Frequency Channel			
Channel	Frequency (GHz)	Channel	Frequency (GHz)
38	5.190	45	5.230

802.11ac(80MHz) Frequency Channel			
Channel	Frequency (GHz)	Channel	Frequency (GHz)
42	5.210	\	\

4.5 Test Mode

Each of these EUT operation mode(s) or test configuration mode(s) mentioned above was evaluated respectively.

Pretest Mode	Description	
Mode 1	CH36	802.11a
Mode 2	CH40	
Mode 3	CH48	
Mode 4	RX	
Mode 5	CH36	802.11n20
Mode 6	CH40	
Mode 7	CH48	
Mode 8	RX	
Mode 9	CH38	802.11n40
Mode 10	CH46	
Mode 11	RX	
Mode 12	CH36	
Mode 13	CH40	802.11ac20
Mode 14	CH48	
Mode 15	RX	
Mode 16	CH38	
Mode 17	CH46	802.11ac40
Mode 18	RX	
Mode 19	CH42	802.11ac80

4.6 Test Conditions

The devices was tested while in a continuous transmitter/receiver mode.
The EUT was tuned to a low, middle, and high channel for all tests. For all test case pre/scans were completed in all Modes to determine worst case levels.

Power Supply Voltage Fluctuation Test

Voltage Fluctuation Test	Normal Voltage	High Voltage +10% of Normal Voltage	Low Voltage -10% of Normal Voltage
Input DC Power	5V	5.5V	4.5V
Voltage Variation (%)	0%	+10%	-10%

Note:

Voltage Variation (%)= (Output high or Low Voltage - Output Normal Voltage)/ Output Normal Voltage* 100

During the input supply voltage to the EUT from the external power source is varied by +/-10%, +/-10% of the external power change, will not affect the voltage of the RF, so only operated in normal voltage to test all regulations.

4.7 Table Of Parameters Of Test Software Setting

During testing channel & power controlling software provided by the customer was used to control the operating channel as well as the output power level. The RF output power selection is for the setting of RF output power expected by the customer and is going to be fixed on the firmware of the final end product power parameters

Test software Version	QRCT4		
Frequency	DEF	DEF	DEF
Parameters	5180 MHz	5190 MHz	5200MHz
Frequency	DEF	DEF	DEF
Parameters	5210 MHz	5230 MHz	5240MHz

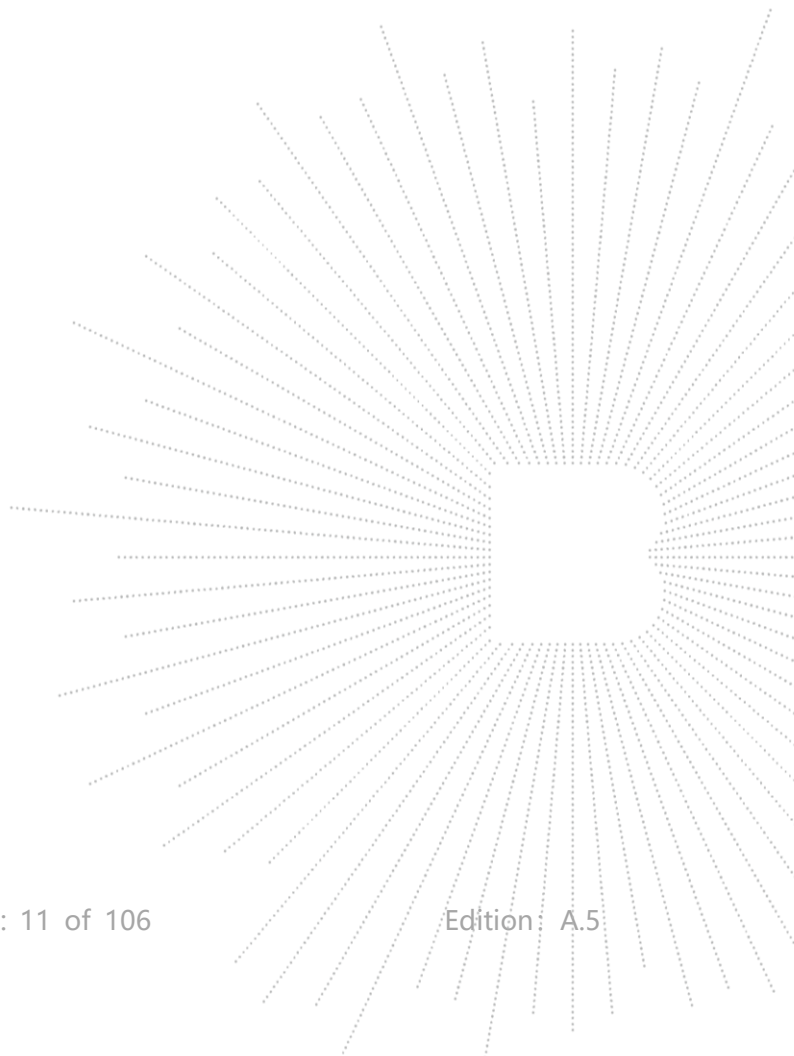

5. Test Facility And Test Instrument Used

5.1 Test Facility

All measurement facilities used to collect the measurement data are located at Shenzhen BCTC Testing Co., Ltd. Address:1-2/F., Building B, Pengzhou Industrial Park, No.158, Fuyuan 1st Road, Zhancheng, Fuhai Subdistrict, Bao'an District, Shenzhen, Guangdong, China. The site and apparatus are constructed in conformance with the requirements of ANSI C63.4 and CISPR 16-1-1 other equivalent standards.

FCC Test Firm Registration Number: 712850

IC Registered No.: 23583

5.2 Test Instrument Used

Item	Equipment	Manufacturer	Type No.	Serial No.	Last calibration	Calibrated until
1	Power meter	Keysight	E4419	\	May 26, 2022	May 25, 2023
2	Signal Analyzer20kHz-26.5GHz	Keysight	N9020A	MY49100060	May 26, 2022	May 25, 2023
3	D.C. Power Supply	LongWei	TPR-6405D	\	\	\
4.	Signal Generator	Keysight	N5182B	MY56200519	May 24, 2022	May 23, 2023
5.	Attenuator	\	10dB DC-6GHz	1650	May 24, 2022	May 23, 2023

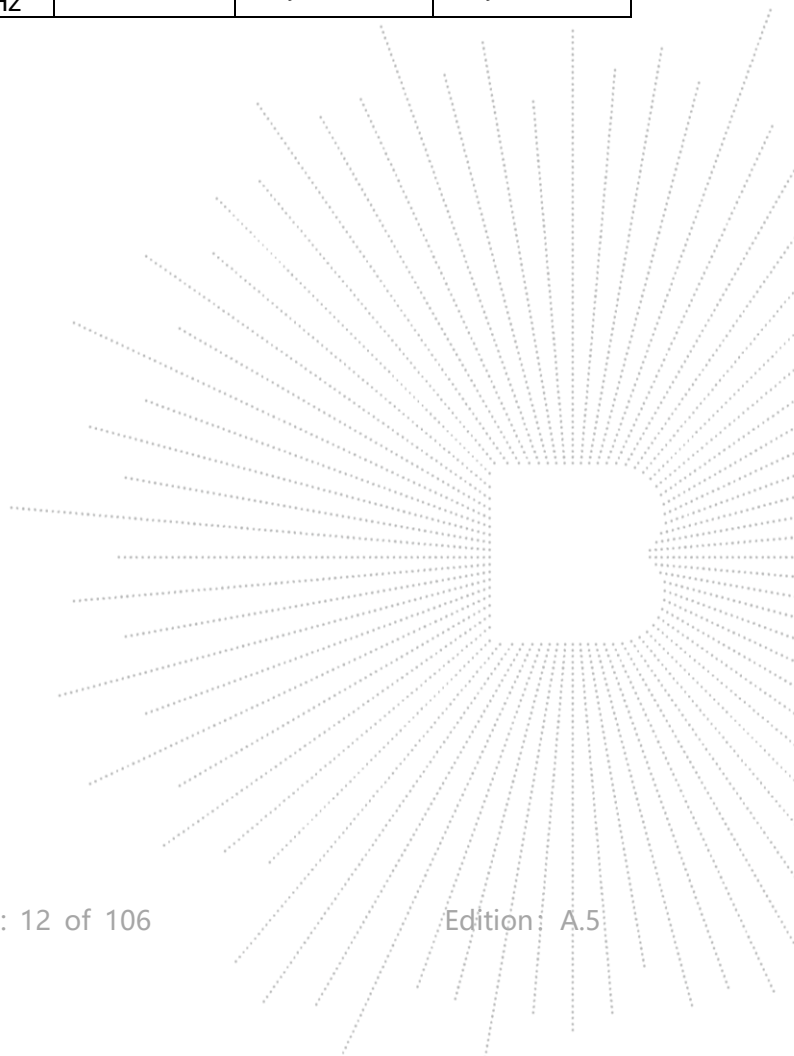

6. RF Shielding Method

Enclosure:

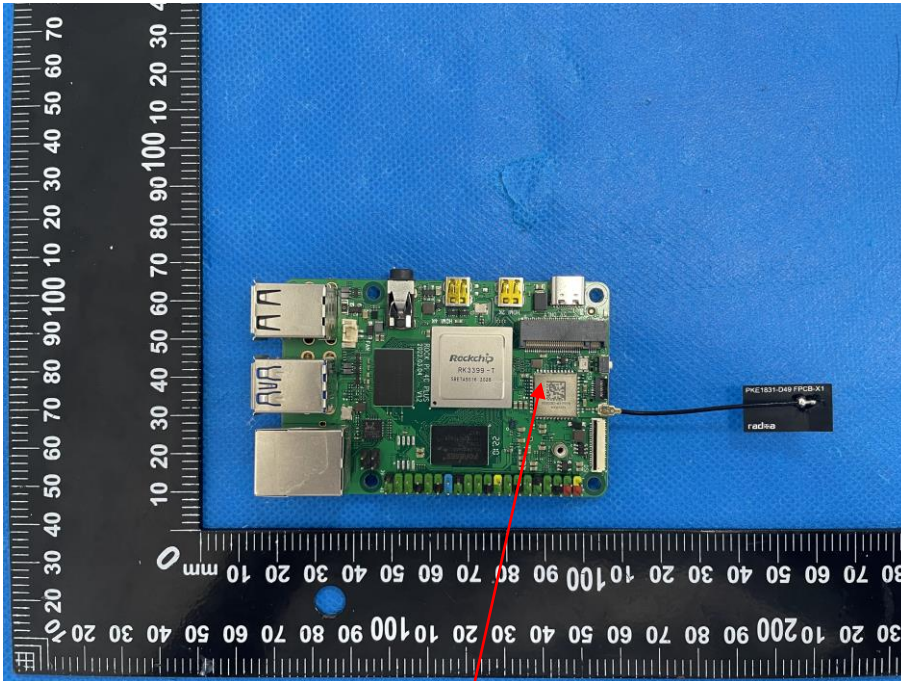

Built-in shielding cover

7. Frequency Error

7.1 Block Diagram Of Test Setup

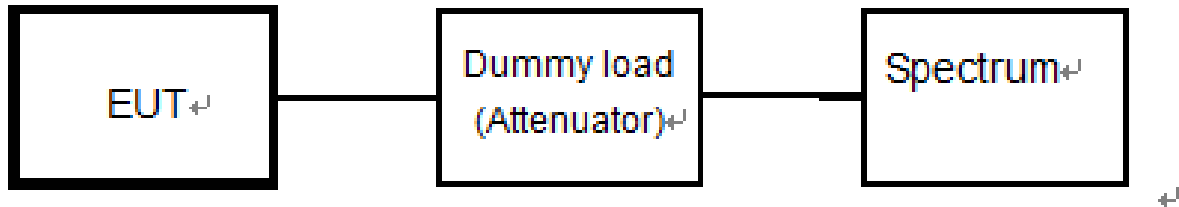

7.2 Limit

Item	Limits
Frequency Error	±20ppm

7.3 Measuring Instruments And Setting

The following table is the setting of Spectrum Analyzer.

Spectrum Parameter	Setting
Attenuation	Auto
RB / VB	30KHz
Detector	Peak
Trace	Max Hold
Sweep Time	Auto

7.4 Test Procedure

- (1) In the case of unmodulated signal (continuous or continuous burst), measure the frequency directly by a frequency meter.
- (2) In the case of burst waves, the measurement shall be done for enough time in order to obtain the enough measuring accuracy, and the average of the measured values becomes the final value.
- (3) In the case of a test mode with a specific frequency spectrum, measure the frequency of the specific spectrum by a spectrum analyzer.
- (4) In the cases above, if the frequency equivalent to the test frequency is not directly measured in principle, it shall be obtained by necessary calculation.
 In the case of modulated signal, if there is no specific spectrum measurable by a spectrum analyzer but a specific dip is observed, it is allowed to measure the frequency with the signal generator (synthesized). That is, observe a signal of the signal generator concurrently (or alternately) with the tested signal using the spectrum analyzer while setting the frequency of the signal generator to the position of the dip on the screen of the spectrum analyzer, and determine the frequency of the signal generator at the time as a measured value.

7.5 Test Result

Operation Mode:	Transmitting- unmodulation mode
-----------------	---------------------------------

Test Voltage	Test Frequency (MHz)	Measured Frequency (MHz)	Frequency Error(ppm)	Limit (ppm)	P/F
Normal Voltage	5180	5179.925	-14.48	±20	PASS
	5200	5199.925	-14.42	±20	PASS
	5240	5239.926	-14.12	±20	PASS
	5190	5189.928	-13.87	±20	PASS
	5230	5229.928	-13.77	±20	PASS
	5210	5209.929	-13.63	±20	PASS

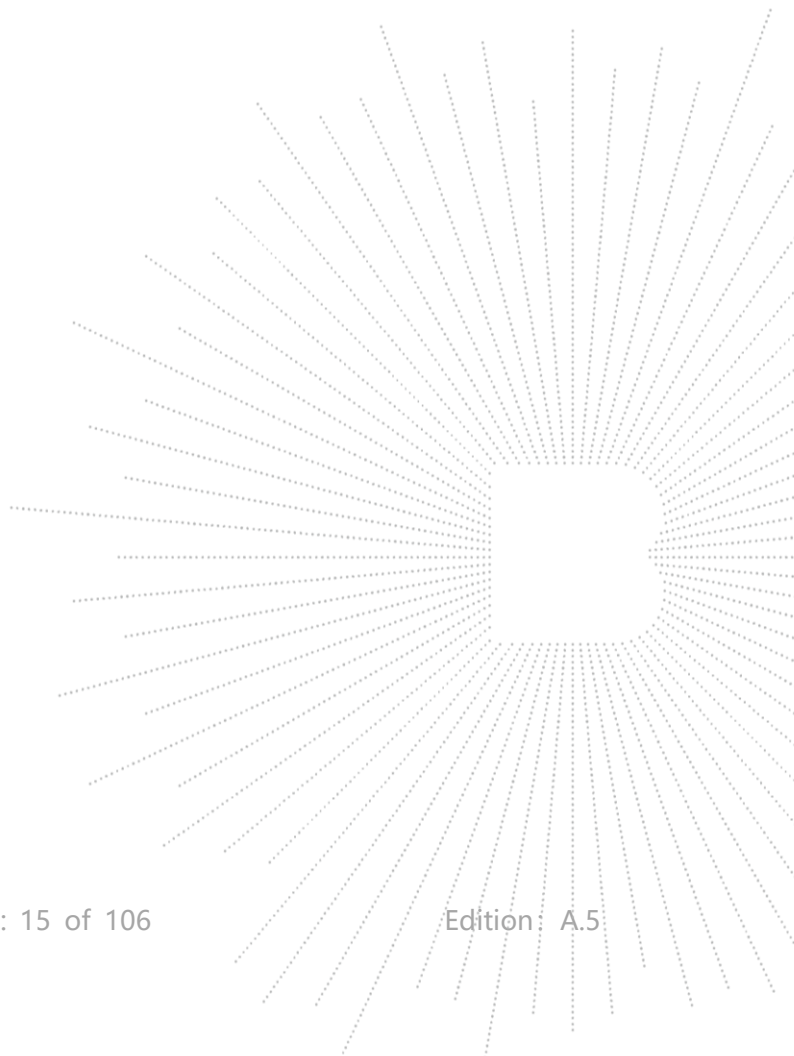

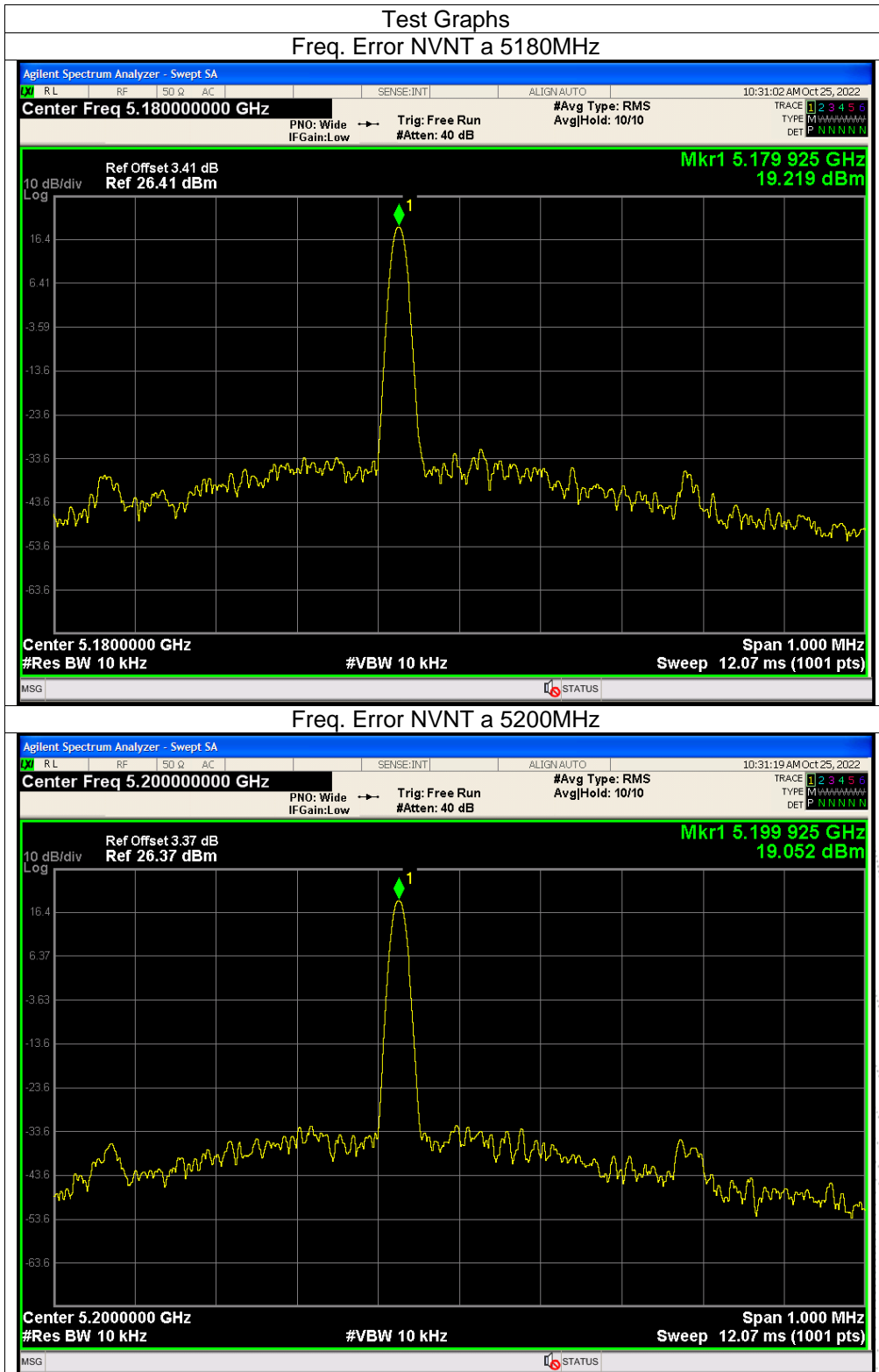

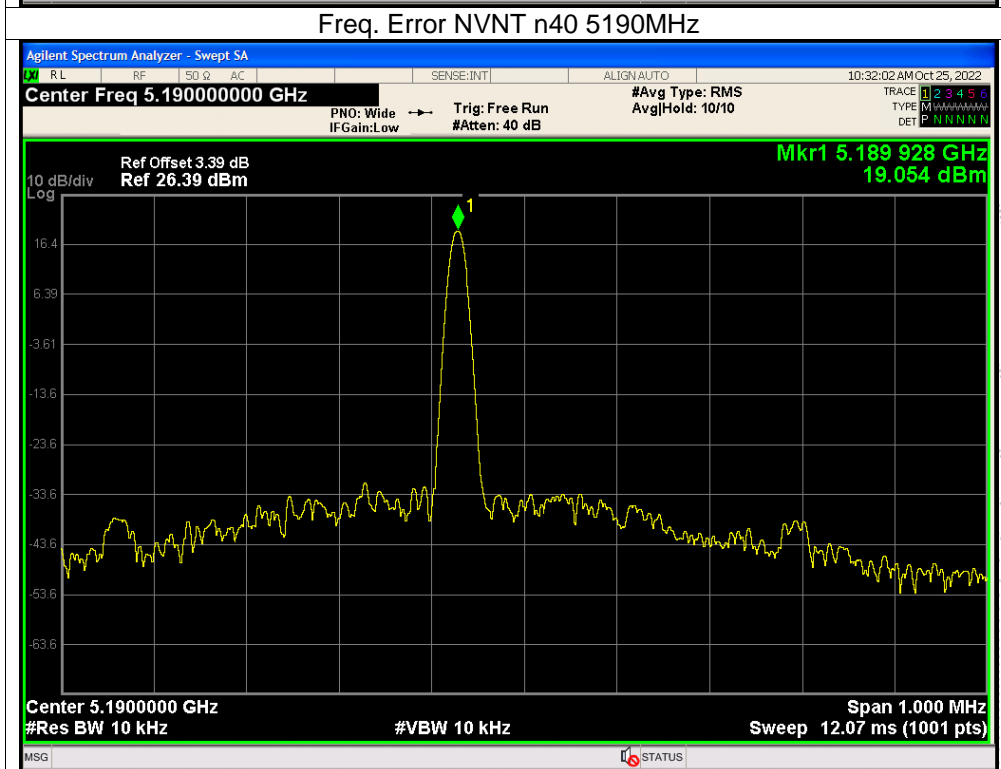
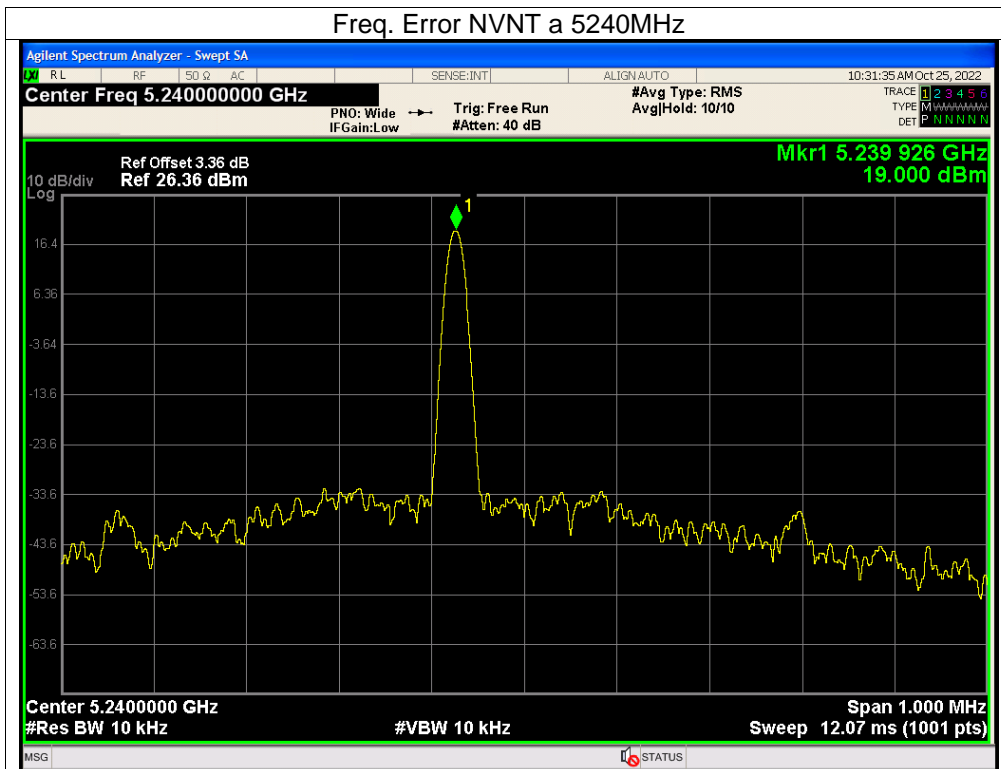

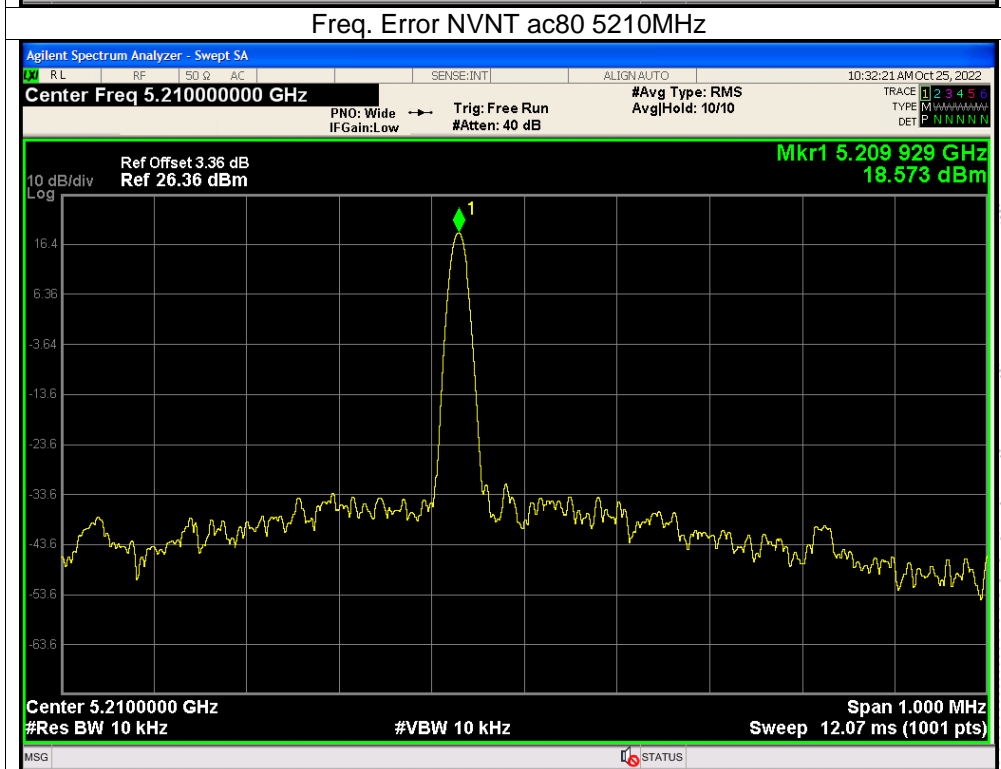
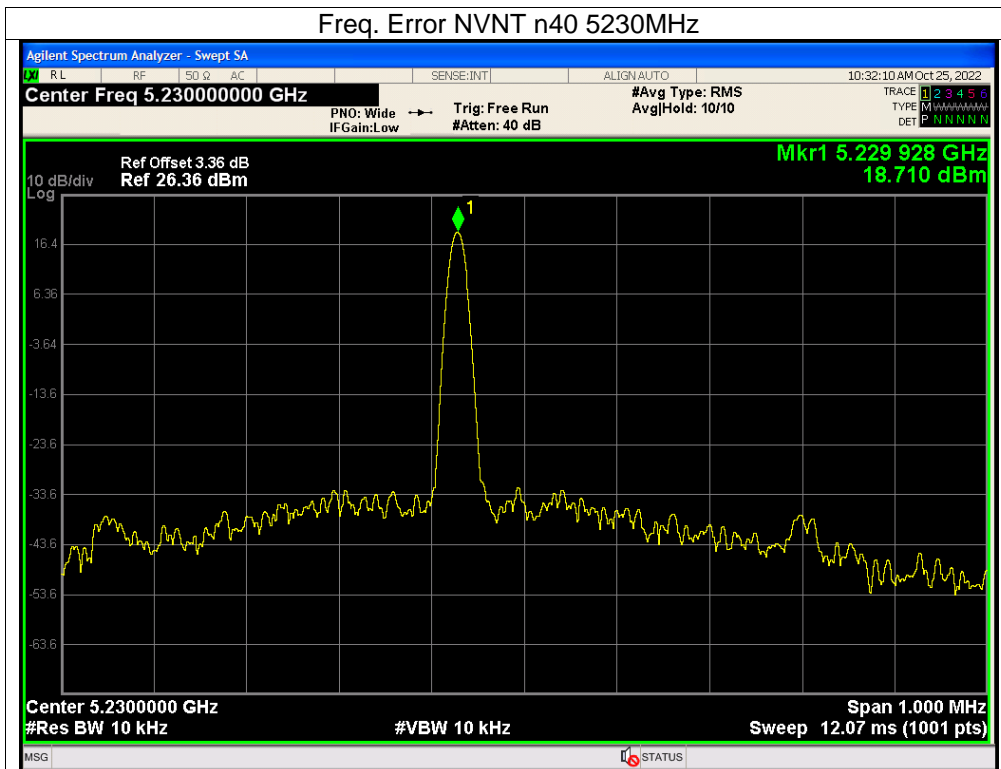

8. Antenna Power

8.1 Block Diagram Of Test Setup

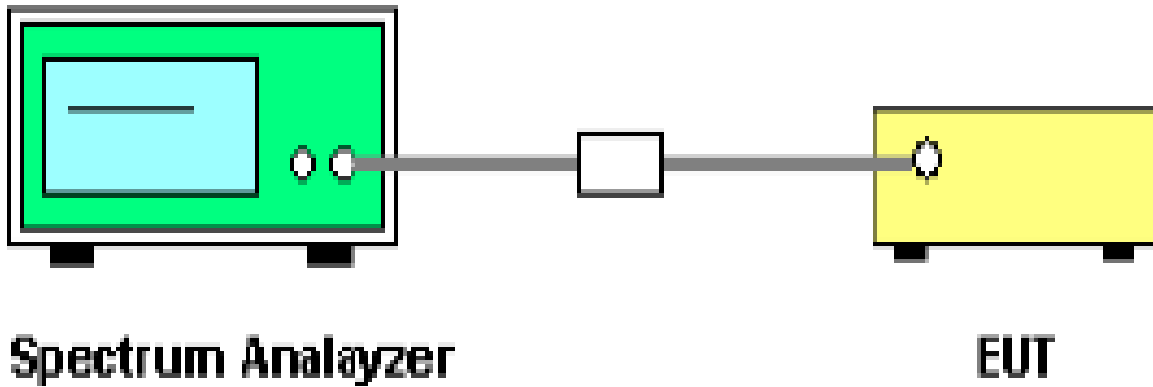

8.2 Limit

Item	Limits
Antenna Power	802.11a20/n20/ac20 \leq 10mW/MHz 802.11n40/ac40 \leq 5mW/MHz 802.11ac80 \leq 2.5mW/MHz
Antenna Power tolerance	+20%, -80% (Base on manufacturer declare antenna power density)

8.3 Measuring Instruments And Setting

The following table is the setting of Spectrum Analyzer.

Spectrum Parameter	Setting
Attenuation	Auto
RB / VB	1 MHz
Detector	Peak
Trace	Max Hold
Sweep Time	Auto

8.4 Test Procedure

1. EUT Connect the to the spectrum analyzer.
2. Adjust the spectrum analyzer to have the center frequency the same with the measured carrier. RBW=VBW=1MHz, detector mode is positive peak. Turn off the averaging function and use zero span.
3. The calibrating signal power shall be reduced to 0 dBm and it shall be verified that the power meter reading also reduces by 10 dB.
- 4 . Connect the equipment to be measured. Using the following settings of the spectrum analyzer in combination with "max hold" function, find the frequency of highest power output in the power envelope: center frequency equal to operating frequency; RBW & VBW: 1 MHz; detector mode: positive peak; averaging: off; span: 3 times the spectrum width; amplitude: adjust for middle of the instrument' range. The frequency found shall be recorded.
- 5 . Set the center frequency of the spectrum analyzer to the found frequency and switch to zero span. The power meter indicates the measured power density "E".
6. Calculate antenna power density by the formula below $PD = Pt + 10 \cdot \log(1/x)$.
x: The duty cycle of the EUT in continuously transmitting mode
Pt: Output power of the SSG
7. Antenna Power Error is definition that actual measure antenna power tolerance between + 20% to - 80% power range that base on manufacturer declare the conducted power density.

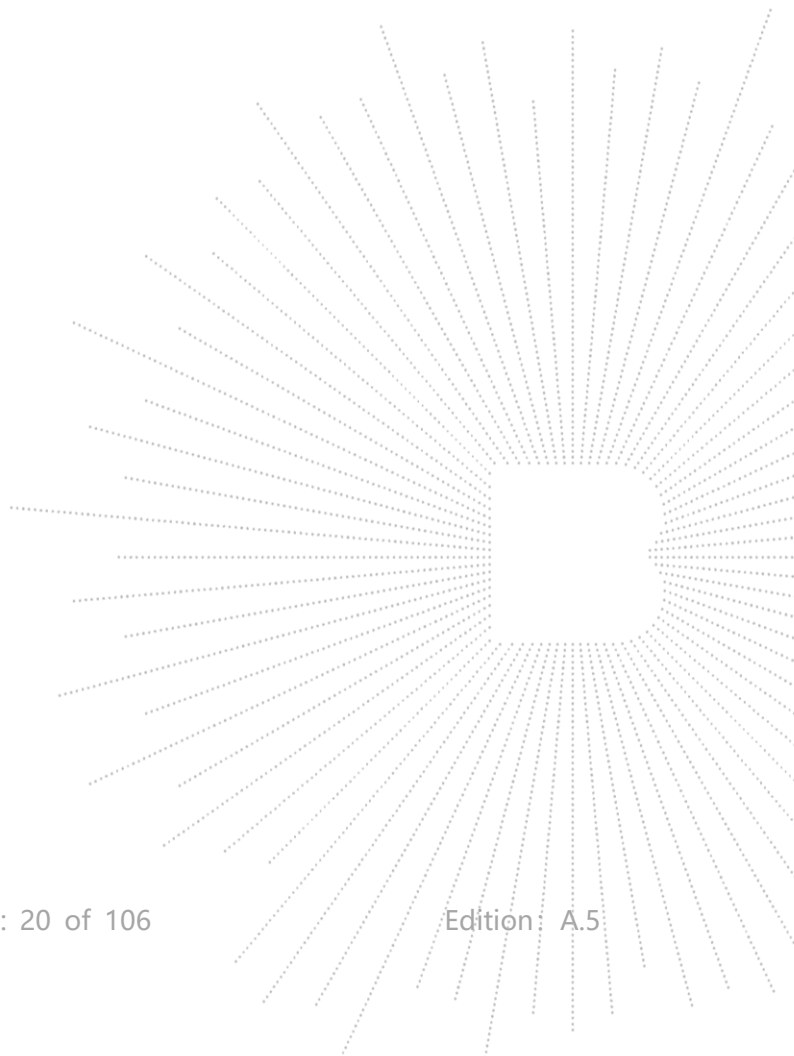

8.5 Test Result

Operation Mode:		Normal Voltage-802.11a Mode					
Test Frequency	Conducted RF output power density (dBm/MHz)	Conducted RF output power density (mW/MHz)	Rated power density (mW/MHz)	Antenna Gain (dBi)	EIRP (mW/MHz)	EIRP Limit (mW/MHz)	Antenna Power Error (%)
5180MHz	4.691	2.945	3	4.10	7.57	10	-2
5200MHz	4.818	3.032	3	4.10	7.79	10	1
5240MHz	4.989	3.154	3	4.10	8.11	10	5
Limit : +20%, -80% (Base on manufacturer declare antenna power density)							

Operation Mode:		Normal Voltage-802.11n20 Mode					
Test Frequency	Conducted RF output power density (dBm/MHz)	Conducted RF output power density (mW/MHz)	Rated power density (mW/MHz)	Antenna Gain (dBi)	EIRP (mW/MHz)	EIRP Limit (mW/MHz)	Antenna Power Error (%)
5180MHz	3.459	2.218	3	4.10	5.70	10	-26
5200MHz	2.787	1.900	3	4.10	4.88	10	-37
5240MHz	3.882	2.445	3	4.10	6.28	10	-19
Limit : +20%, -80% (Base on manufacturer declare antenna power density)							

Operation Mode:		Normal Voltage-802.11n40 Mode					
Test Frequency	Conducted RF output power density (dBm/MHz)	Conducted RF output power density (mW/MHz)	Rated power density (mW/MHz)	Antenna Gain (dBi)	EIRP (mW/MHz)	EIRP Limit (mW/MHz)	Antenna Power Error (%)
5190MHz	-1.125	0.77	2	4.10	1.98	5	-61.5
5230MHz	-1.629	0.69	2	4.10	1.77	5	-65.5
Limit : +20%, -80% (Base on manufacturer declare antenna power density)							

Operation Mode:		Normal Voltage-802.11ac20 Mode					
Test Frequency	Conducted RF output power density (dBm/MHz)	Conducted RF output power density (mW/MHz)	Rated power density (mW/MHz)	Antenna Gain (dBi)	EIRP (mW/MHz)	EIRP Limit (mW/MHz)	Antenna Power Error (%)
5180MHz	3.412	2.194	3	4.10	5.64	10	-27
5200MHz	3.028	2.008	3	4.10	5.16	10	-33
5240MHz	4.257	2.665	3	4.10	6.85	10	-11
Limit : +20%, -80% (Base on manufacturer declare antenna power density)							

Operation Mode:		Normal Voltage-802.11ac40 Mode					
Test Frequency	Conducted RF output power density (dBm/MHz)	Conducted RF output power density (mW/MHz)	Rated power density (mW/MHz)	Antenna Gain (dBi)	EIRP (mW/MHz)	EIRP Limit (mW/MHz)	Antenna Power Error (%)
5190MHz	-1.689	0.68	2	4.10	1.74	5	-66
5230MHz	-1.856	0.65	2	4.10	1.68	5	-67.5
Limit : +20%, -80% (Base on manufacturer declare antenna power density)							

Operation Mode:		Normal Voltage-802.11ac80 Mode					
Test Frequency	Conducted RF output power density (dBm/MHz)	Conducted RF output power density (mW/MHz)	Rated power density (mW/MHz)	Antenna Gain (dBi)	EIRP (mW/MHz)	EIRP Limit (mW/MHz)	Antenna Power Error (%)
5210MHz	-4.018	0.396	1	4.10	1.02	2.5	-37
Limit : +20%, -80% (Base on manufacturer declare antenna power density)							

9. Occupied Bandwidth

9.1 Block Diagram Of Test Setup

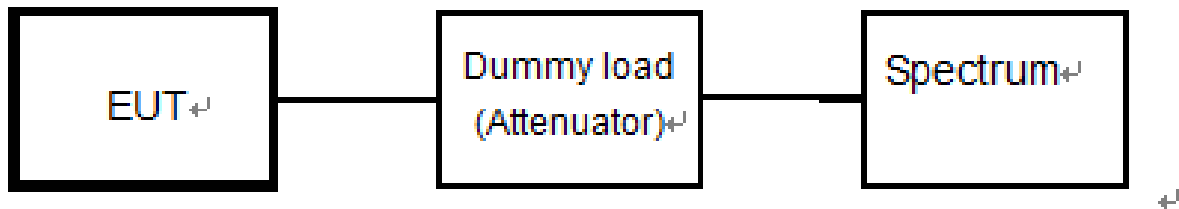

9.2 Limit

Item	Limits
Occupied Bandwidth	Not exceed 20MHz(DSSS 20MHz system) 20MHz(OFDM 20MHz system), 40MHz(OFDM 40MHz system) , 80MHz(OFDM 80MHz system)

9.3 Test Procedure

1. Setting of SA is following as: RB: 300kHz / VB:300kHz / SPAN: 3MHz / AT: 20dB Ref: 10dBm / Sweep time: Auto / Sweep Mode: Continuous sweep / Detect mode: Positive peak / Trace mode: Max hold

2 . EUT have transmitted the maximum modulation signal and fixed channelize (For DSSS or OFDM Device) or continuous maximum power of hopping mode(For FHSS Device).

9.4 Test Result

Condition	Mode	Frequency (MHz)	99% OBW (MHz)	Limit (MHz)	Verdict
NVNT	a	5180	16.447	20	Pass
NVNT	a	5200	16.437	20	Pass
NVNT	a	5240	16.438	20	Pass
NVNT	n20	5180	17.645	20	Pass
NVNT	n20	5200	17.643	20	Pass
NVNT	n20	5240	17.64	20	Pass
NVNT	n40	5190	36.046	40	Pass
NVNT	n40	5230	36.032	40	Pass
NVNT	ac20	5180	17.658	20	Pass
NVNT	ac20	5200	17.643	20	Pass
NVNT	ac20	5240	17.624	20	Pass
NVNT	ac40	5190	36.036	40	Pass
NVNT	ac40	5230	36.041	40	Pass
NVNT	ac80	5210	75.348	80	Pass

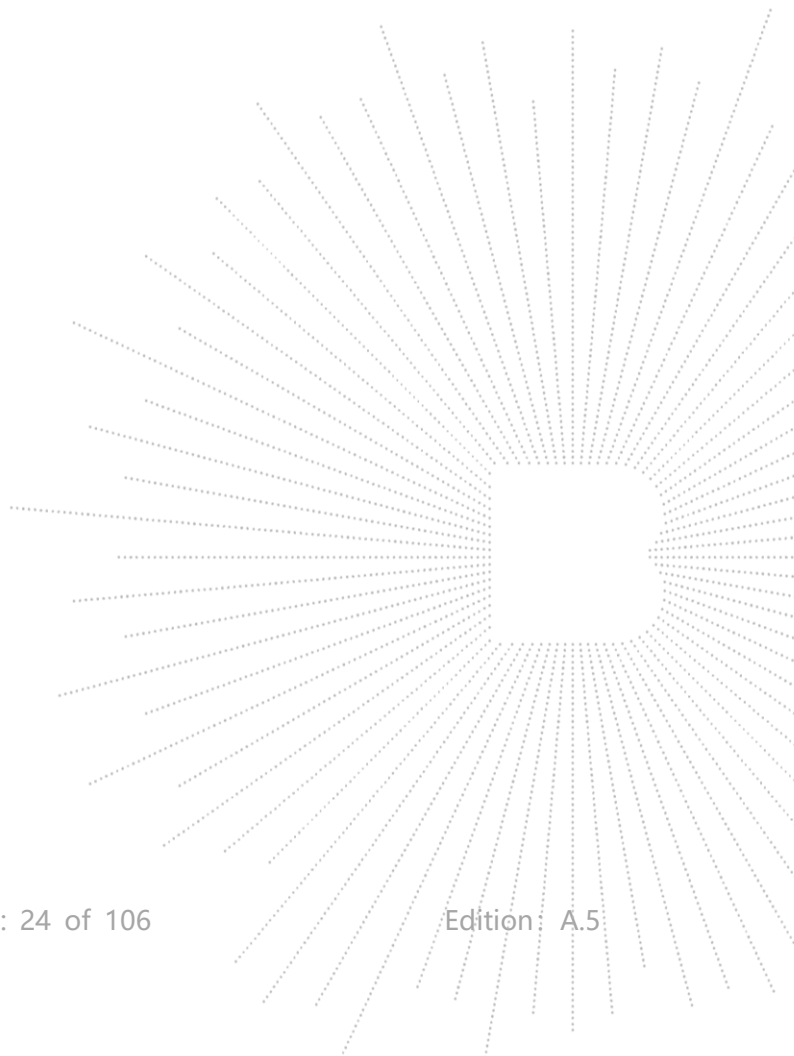

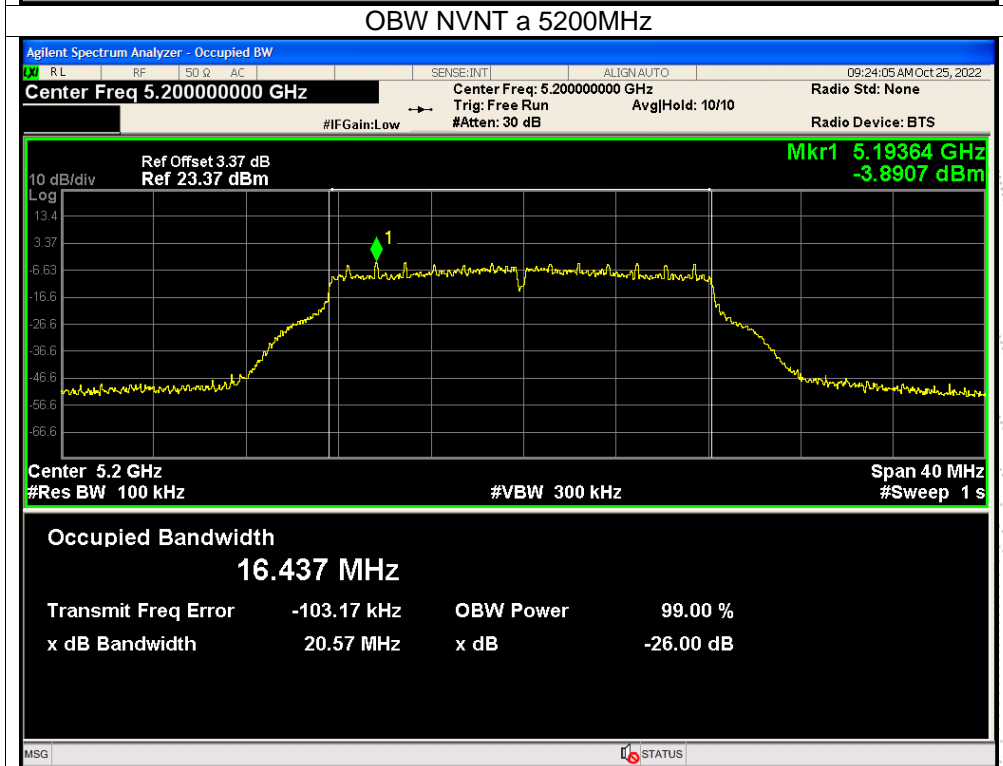
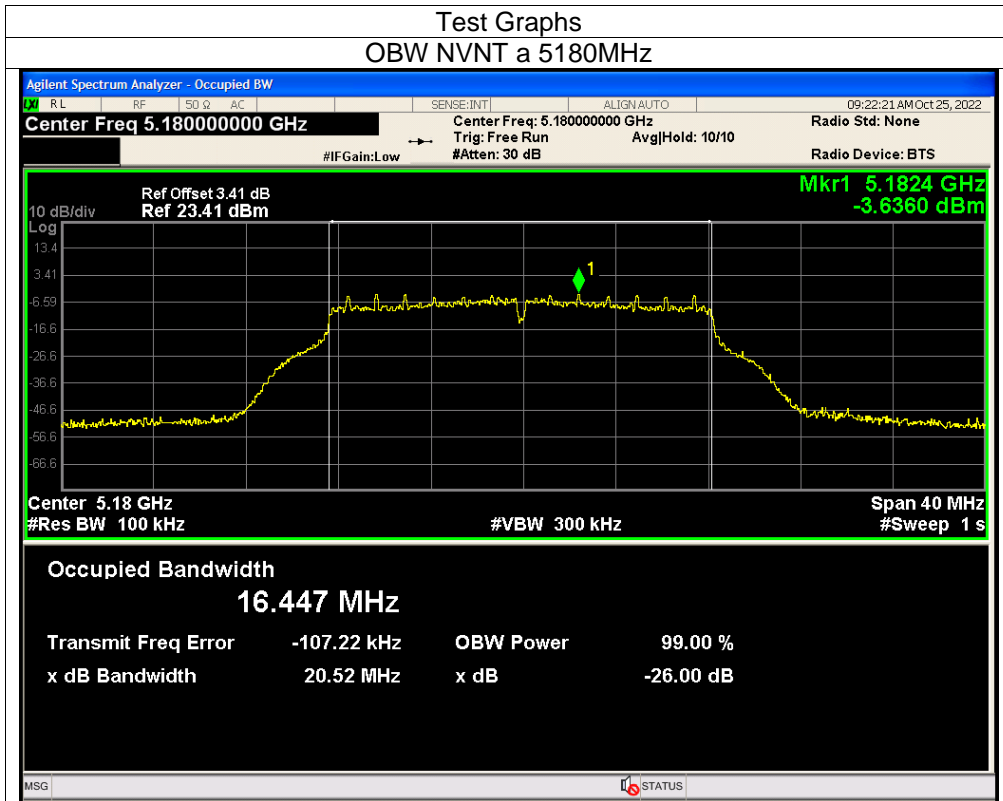

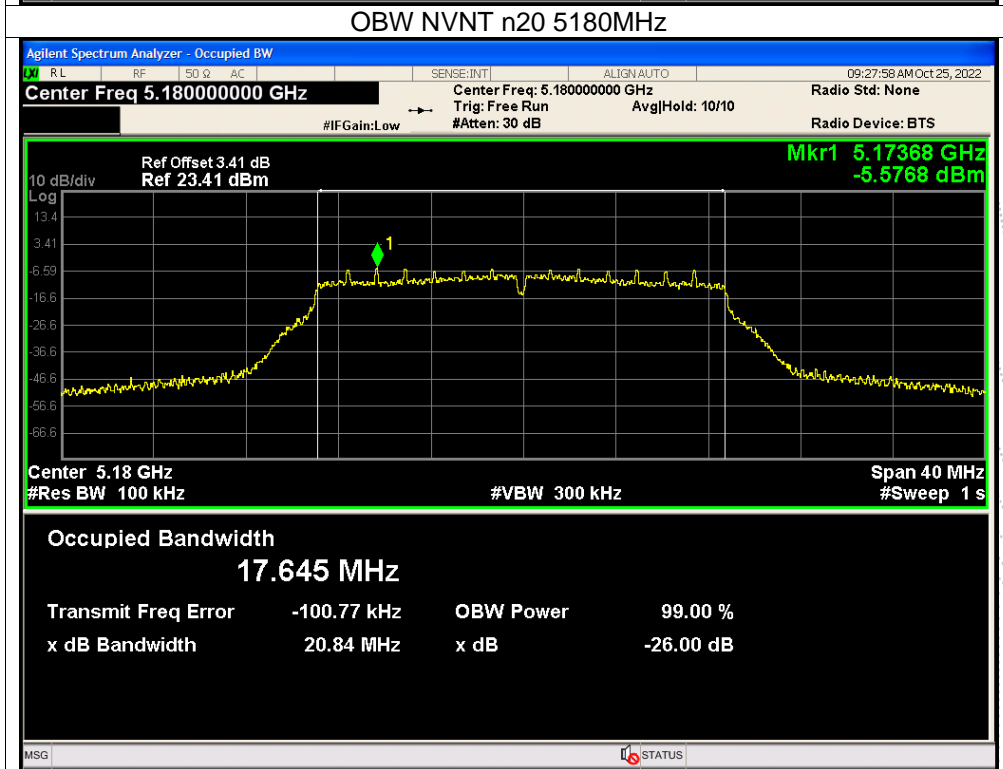
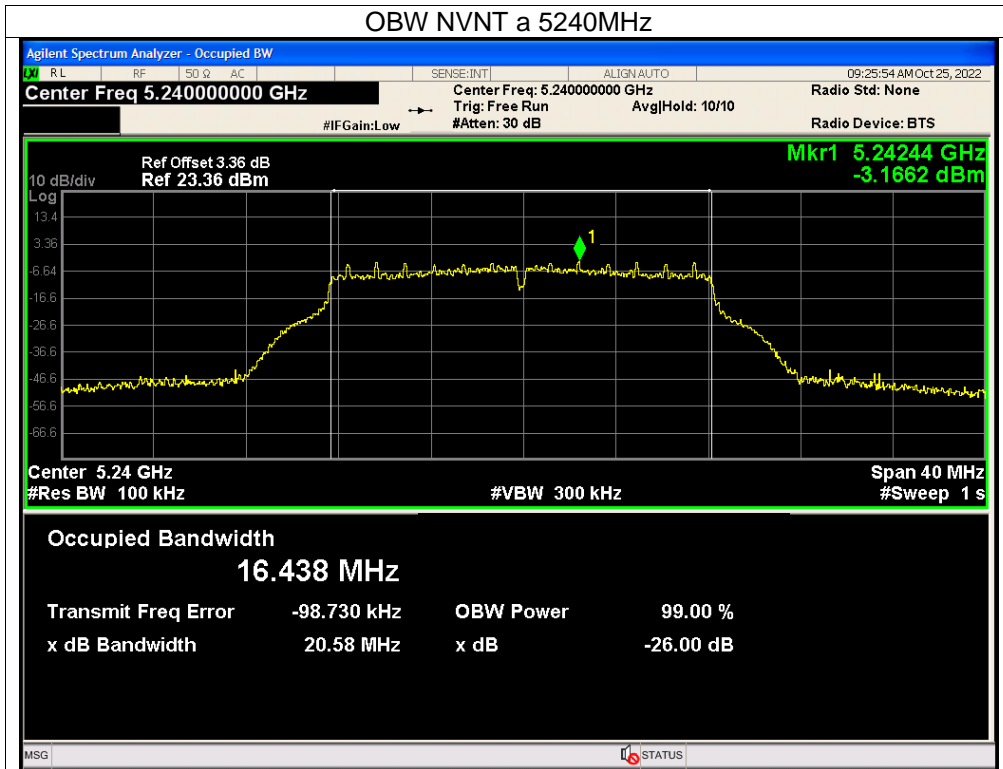

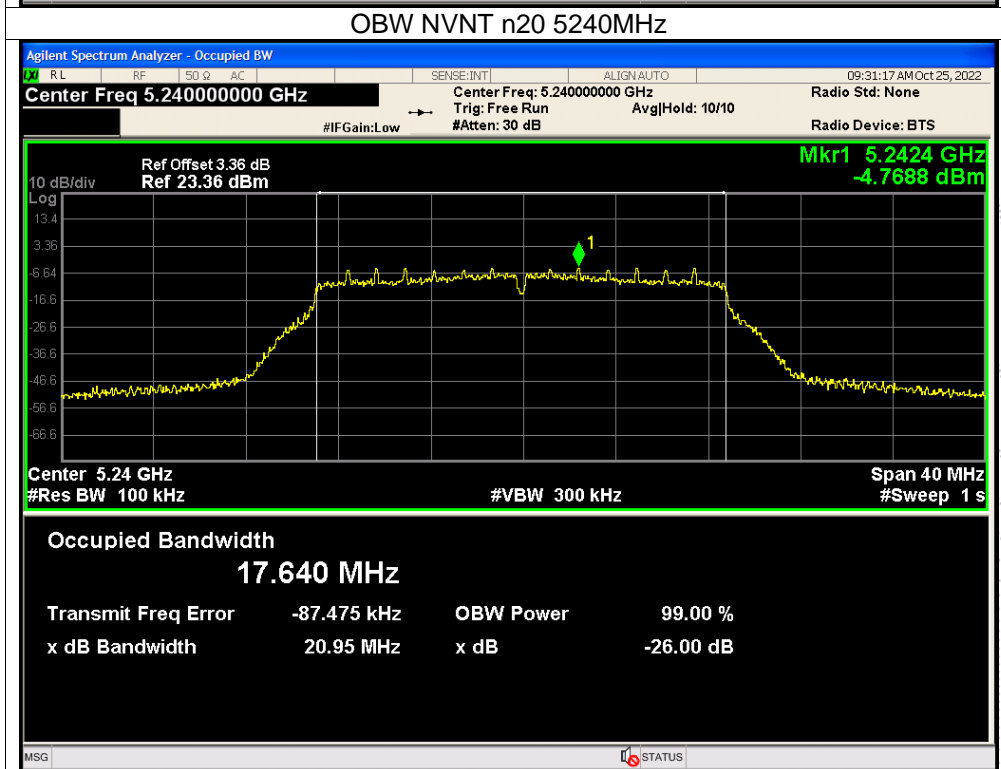
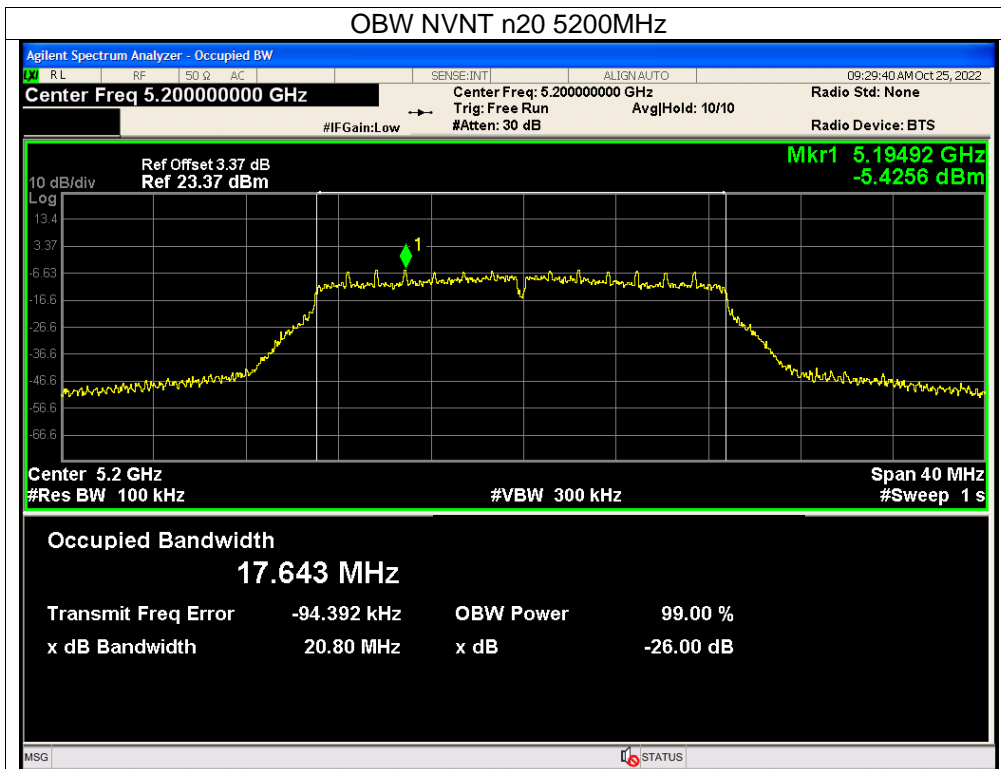

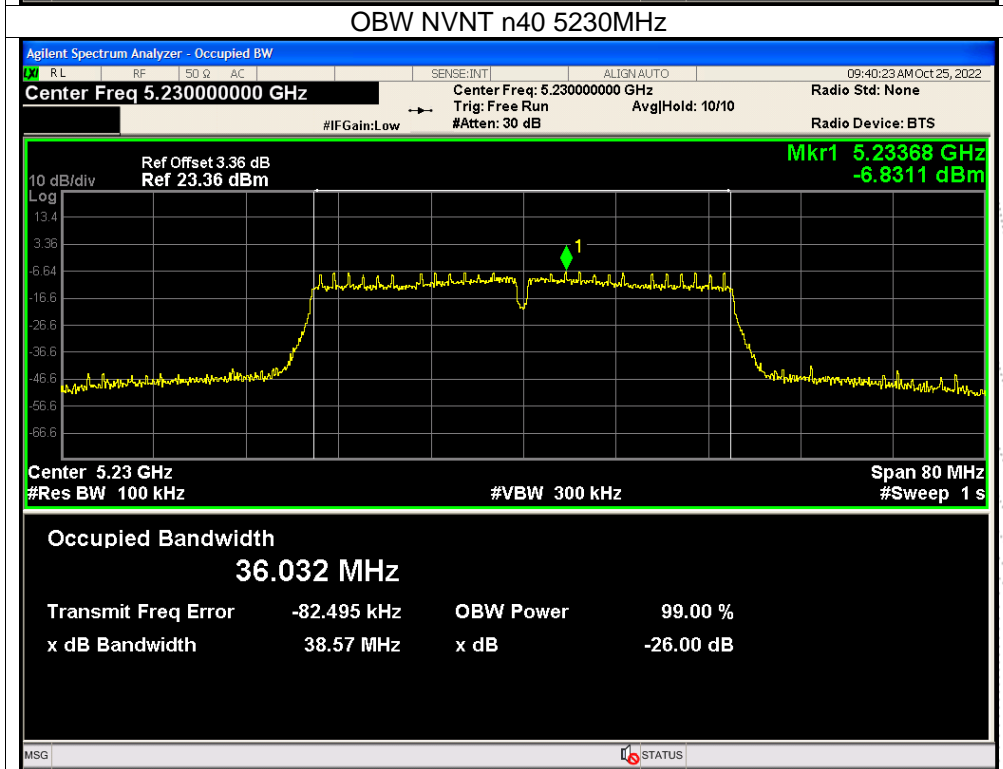
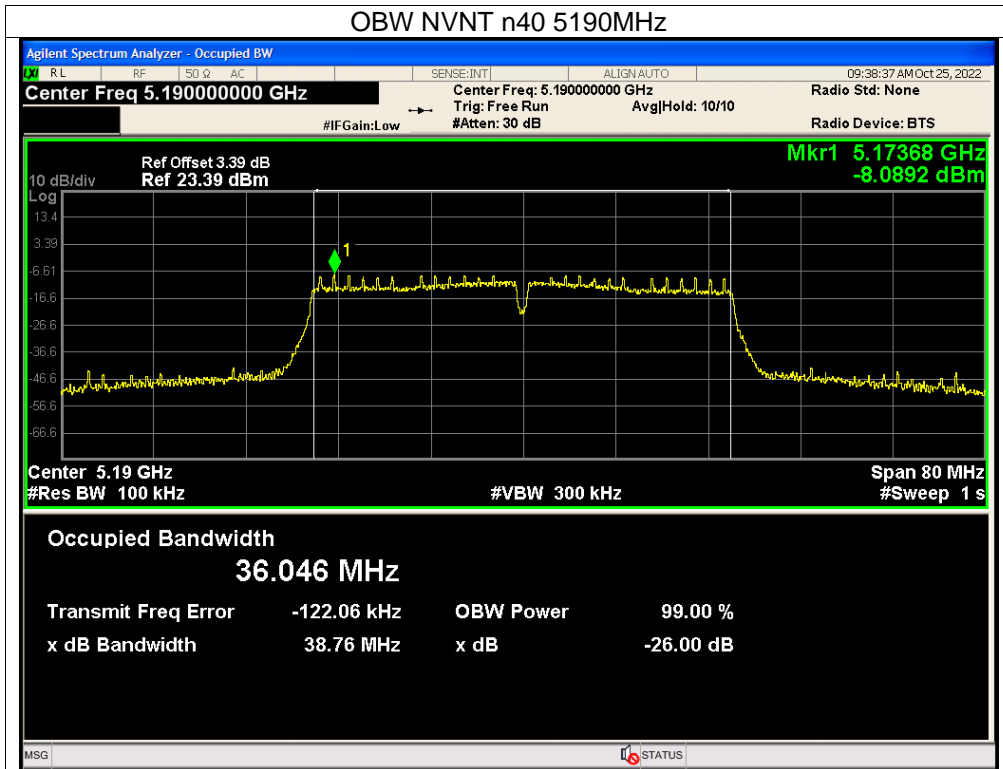

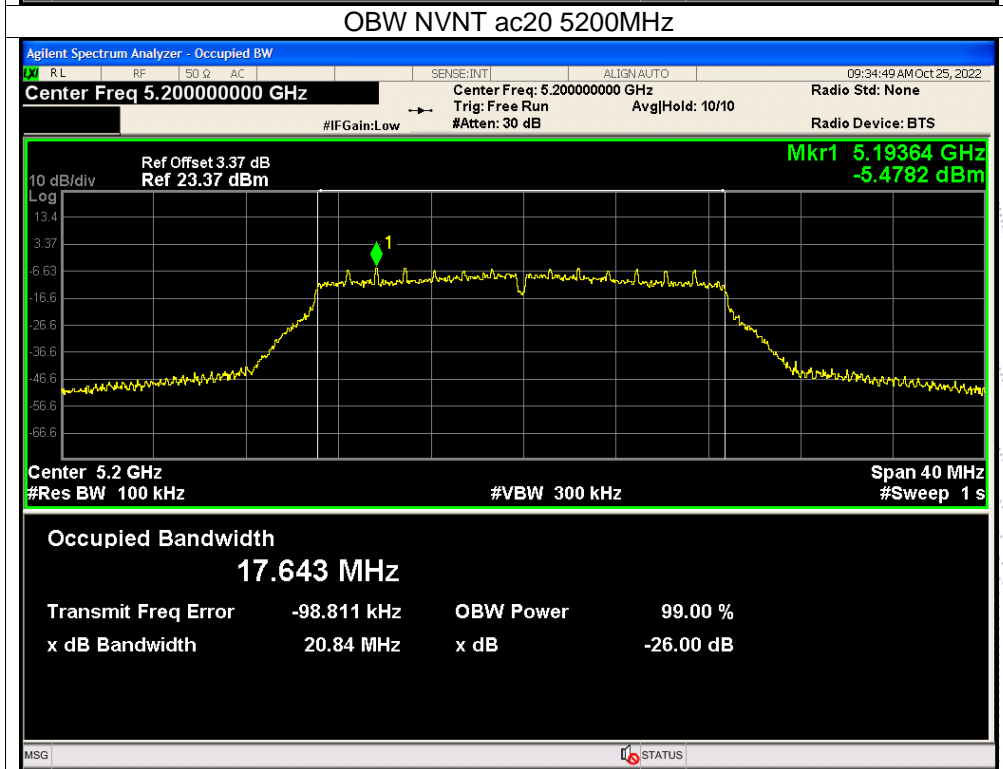
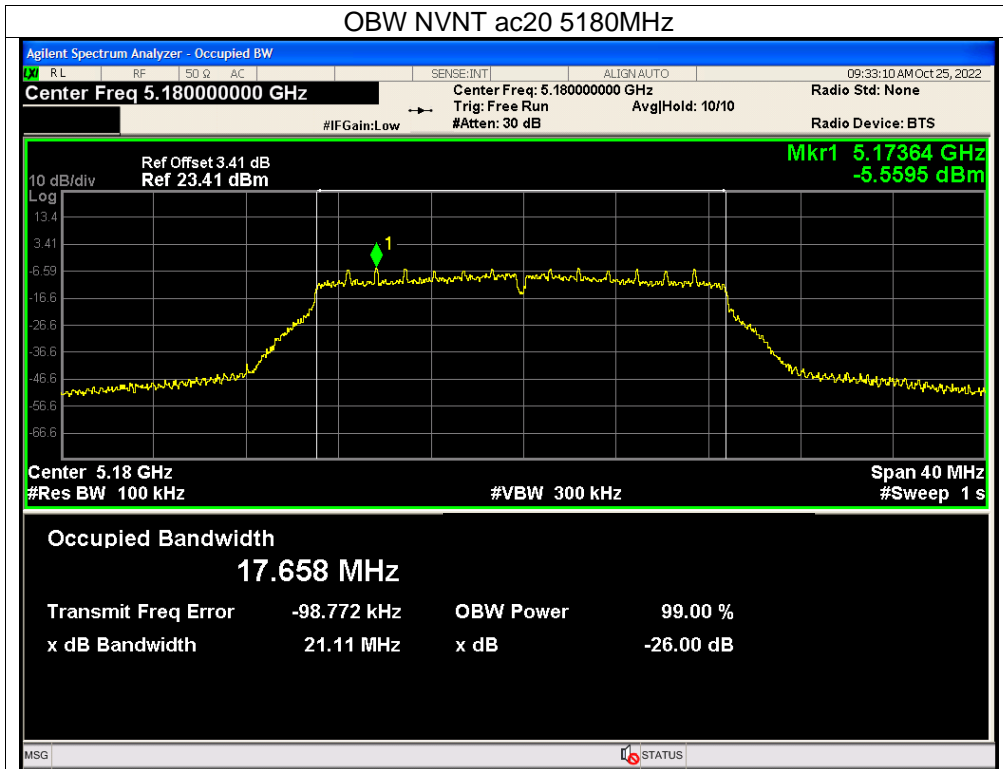

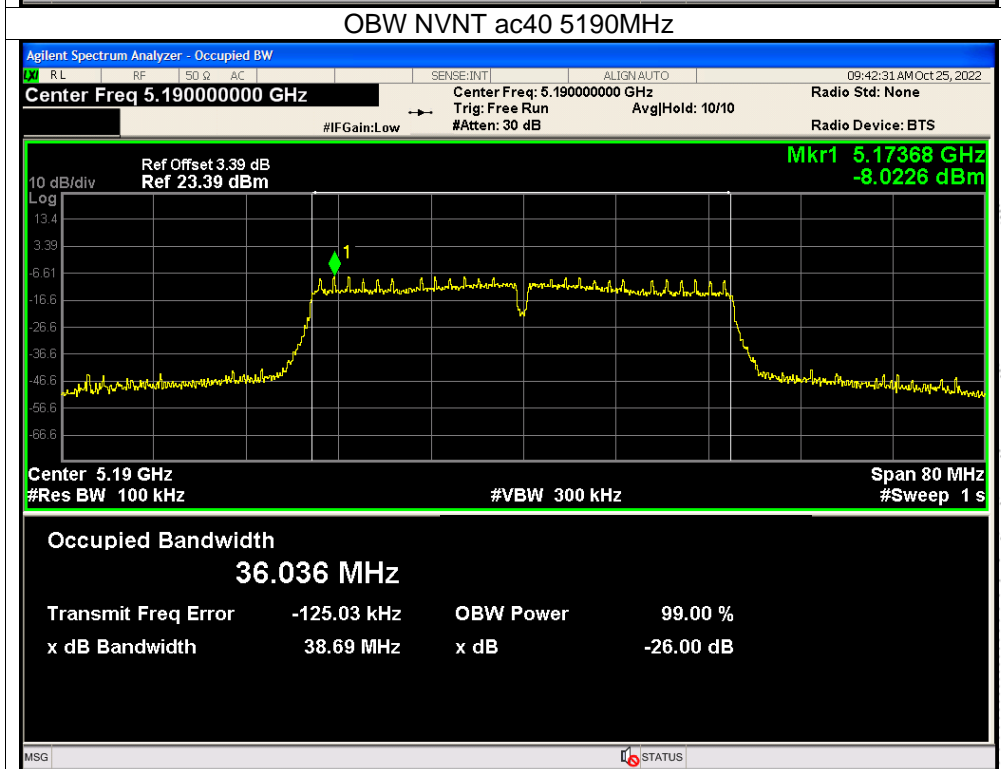
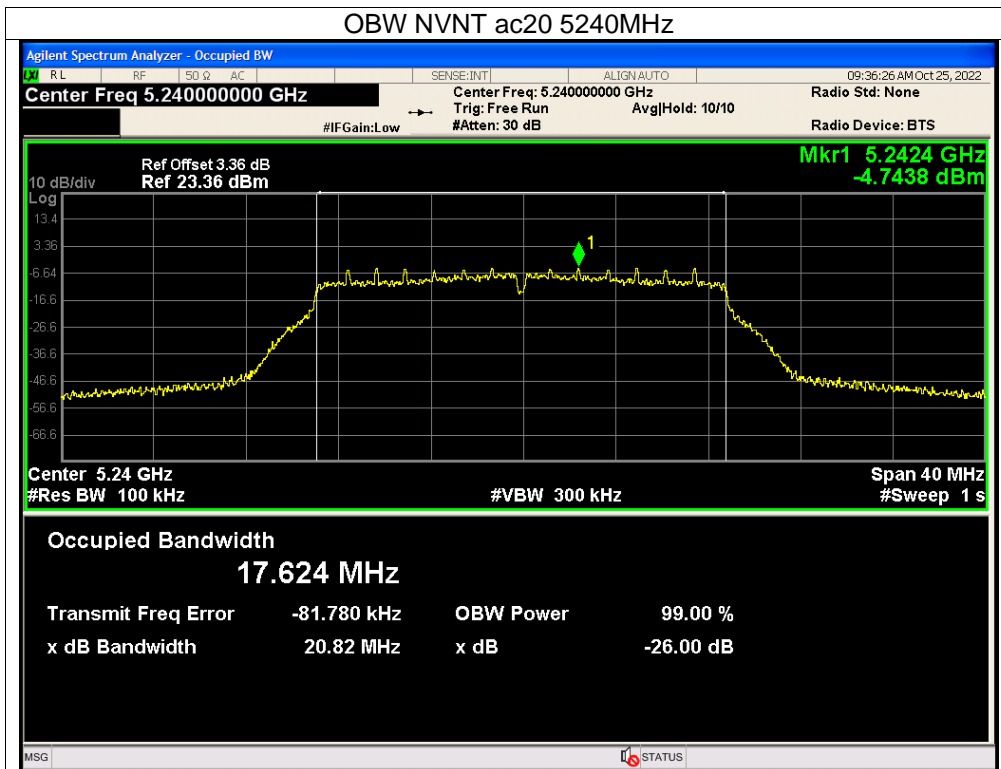

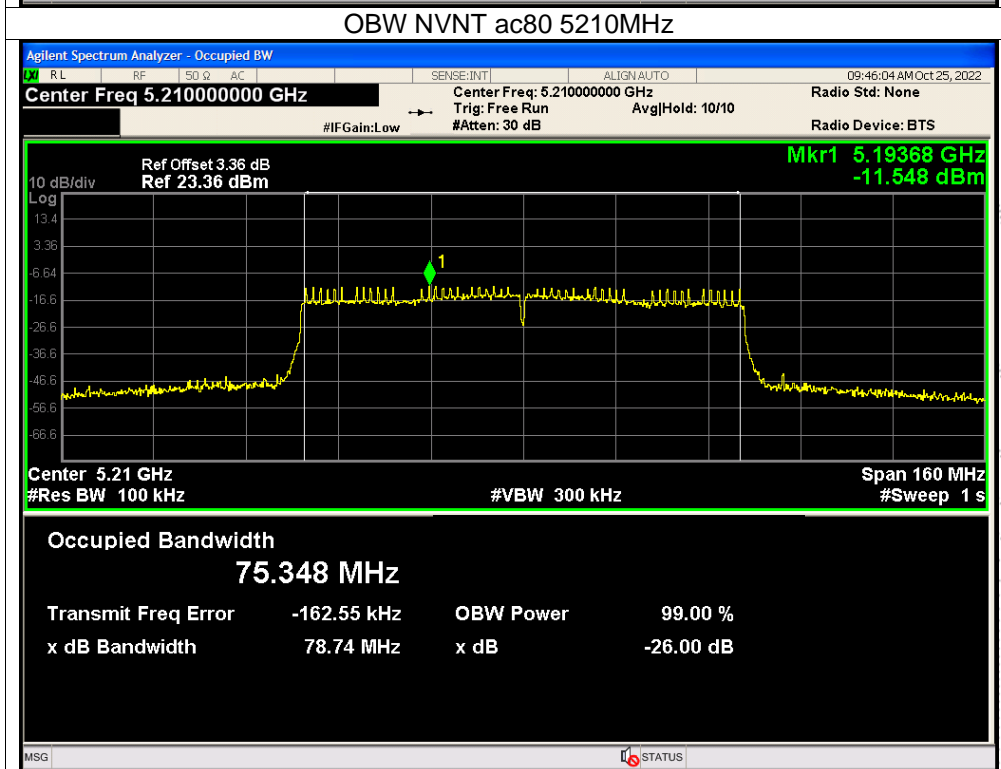
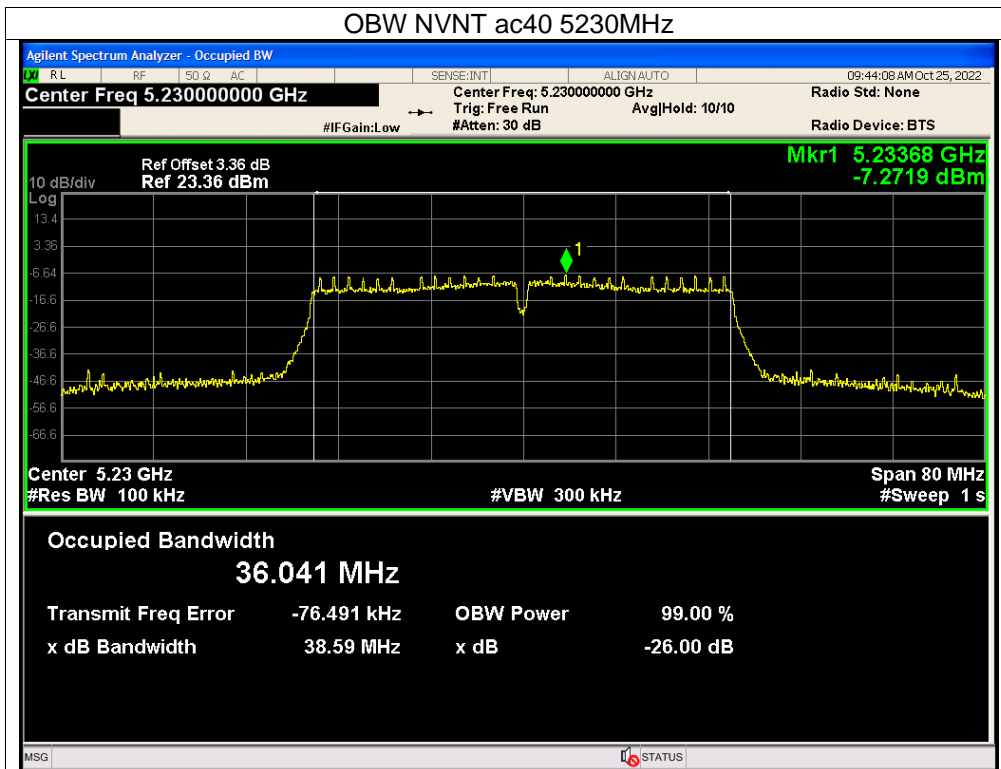

10. Unwanted Emission Intensity Measurement

10.1 Block Diagram Of Test Setup

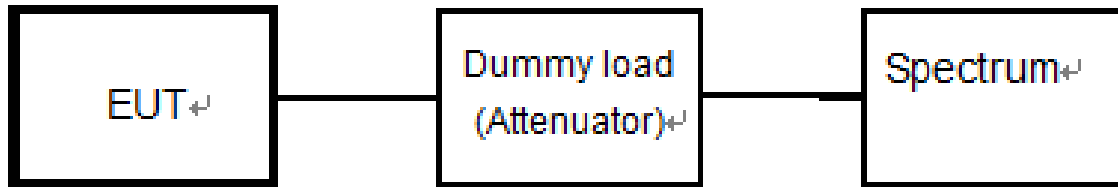

10.2 Limit

20MHz system	
OBW:18-20MHz or less	OBW:18-20MHz
5,142MHz or less: 2.5 μ W/MHz 5,142-5,150 MHz :15 μ W/MHz 5,250-5,251MHz : $10^{1-(f-9)}$ mW/MHz 5,251 - 5,260 MHz: $10^{1-(8/90)(f-11)}$ mW/MHz 5,260 - 5,266.7 MHz: $10^{-1.8-(6/50)(f-20)}$ mW/MHz 5,266.7MHz or more: 2.5 μ W/MHz	5,142MHz or less: 2.5 μ W/MHz 5,142-5,150 MHz :15 μ W/MHz 5,250-5,250.2 MHz : $10^{1-(8/3)(f-9.75)}$ mW/MHz 5,250.2 - 5,251 MHz: $10^{1-(f-9)}$ mW/MHz 5,251 - 5,260 MHz: $10^{1-(8/90)(f-11)}$ mW/MHz 5,260 - 5,266.7 MHz: $10^{-1.8-(6/50)(f-20)}$ mW/MHz 5,266.7MHz or more: 2.5 μ W/MHz
40MHz system	80MHz system
5,141.6MHz or less: 2.5 μ W/MHz 5,141.6-5,150 MHz :15 μ W/MHz 5,250-5,251MHz : $10^{-(f-20)+\log(1/2)}$ mW/MHz 5,251 - 5,270 MHz: $10^{-(8/190)(f-21)-1+\log(1/2)}$ mW/MHz 5,270 - 5,278.4 MHz: $10^{-(3/50)(f-40)-1.8+\log(1/2)}$ mW/MHz 5,278.4MHz or more: 2.5 μ W/MHz	5,123.2MHz or less: 2.5 μ W/MHz 5,123.2-5,150 MHz :15 μ W/MHz 5,250-5,251MHz : $10^{-(f-40)+\log(1/4)}$ mW/MHz 5,251 - 5,290 MHz: $10^{-(8/390)(f-41)-1+\log(1/4)}$ mW/MHz 5,290 - 5,296.7MHz: $10^{-(3/10)(f-80)-1.8+\log(1/4)}$ mW/MHz 5,296.7MHz or more: 2.5 μ W/MHz

10.3 Measuring Instruments And Setting

Please refer to section 5 in this report. The following table is the setting of Spectrum Analyzer.

Spectrum Parameter	Setting
Attenuation	Auto
RB / VB	Below 1GHz: 1 MHz Above 1GHz: 1 MHz
Detector	Peak
Trace	Max Hold
Sweep Time	Auto

10.4 Test Procedure

- EUT have transmitted the maximum modulation signal and fixed channelize.
- Setting of SA is following as: Below 1GHz RB:100KHz / VB:100KHz
 Above 1GHz RB:1MHz / VB:1MHz / AT: 20dB Ref: 10dBm / Sweep time: Auto
 Sweep Mode: Continuous sweep / Detect mode: Positive peak
 Trace mode: Max hold

10.5 Test Result

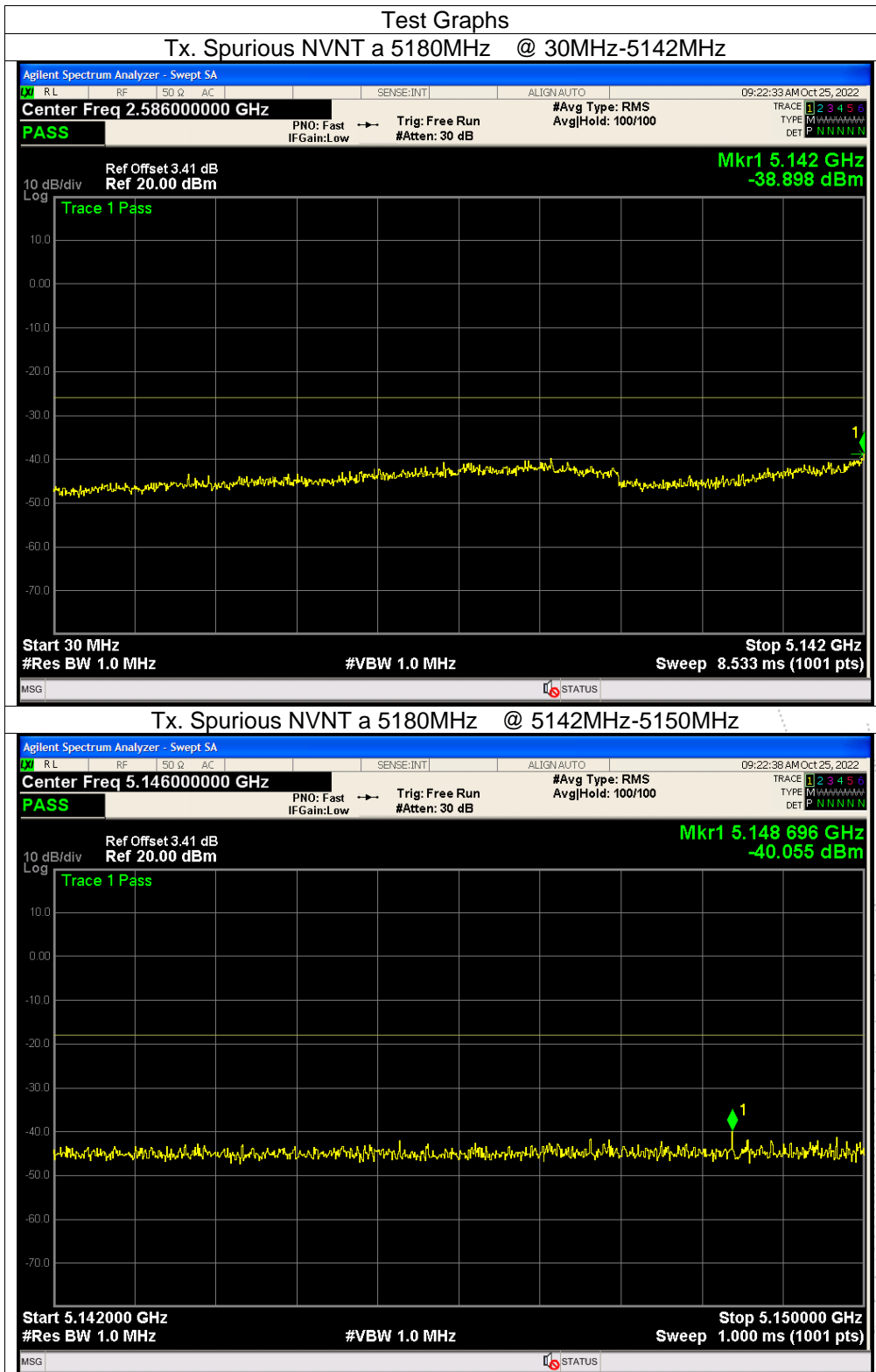

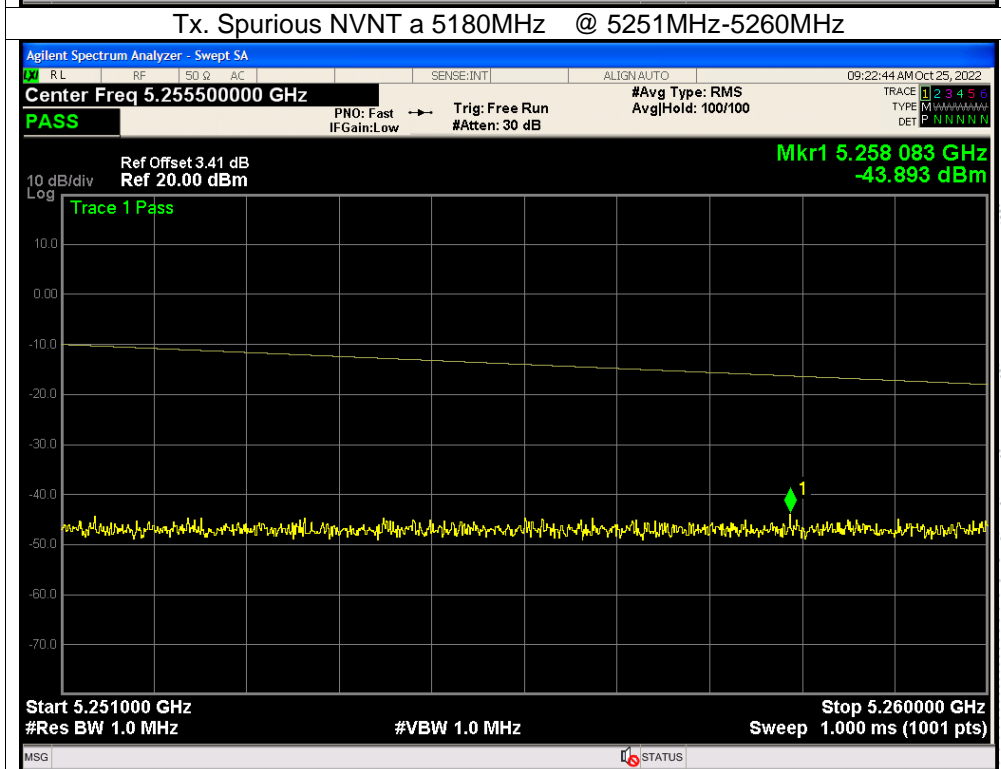
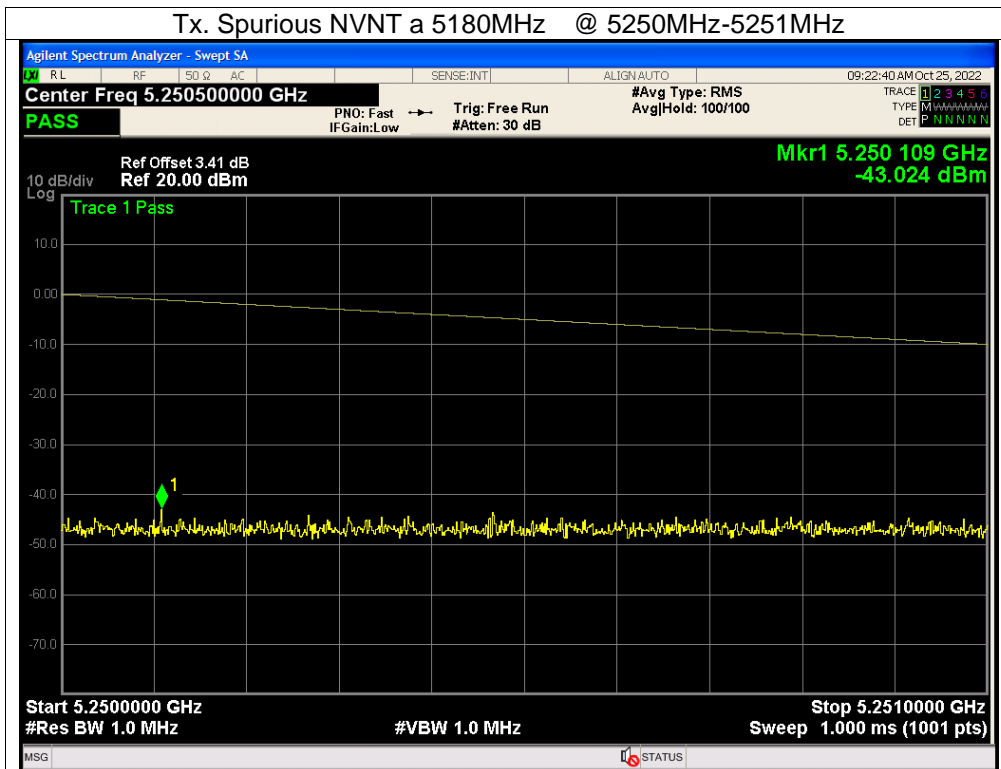

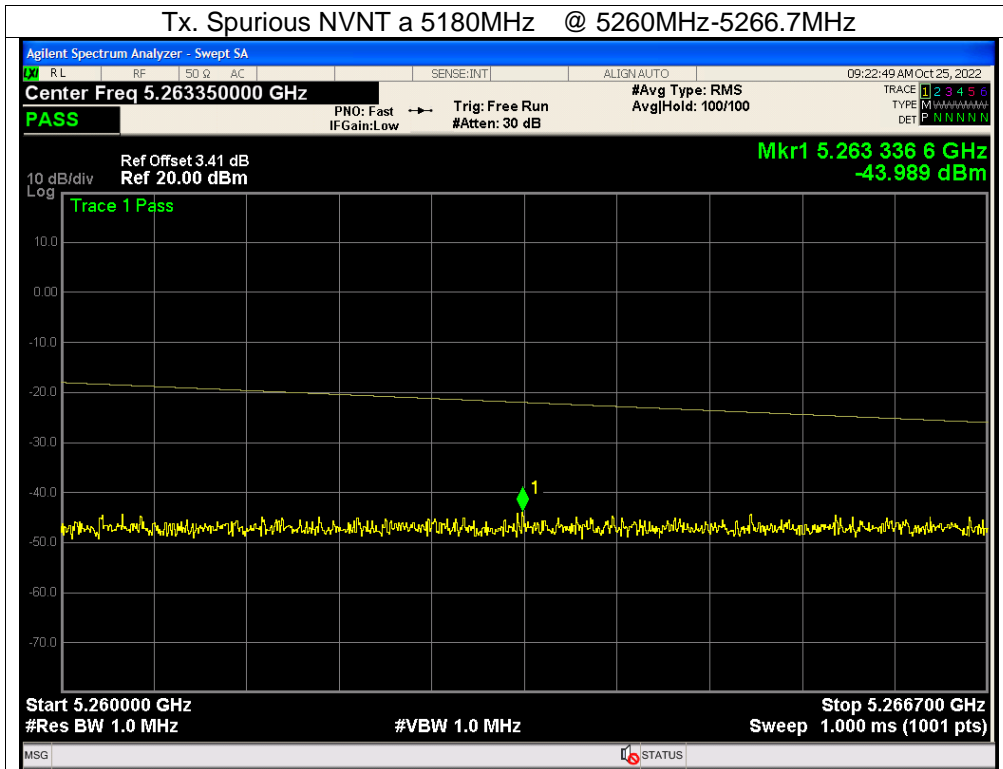

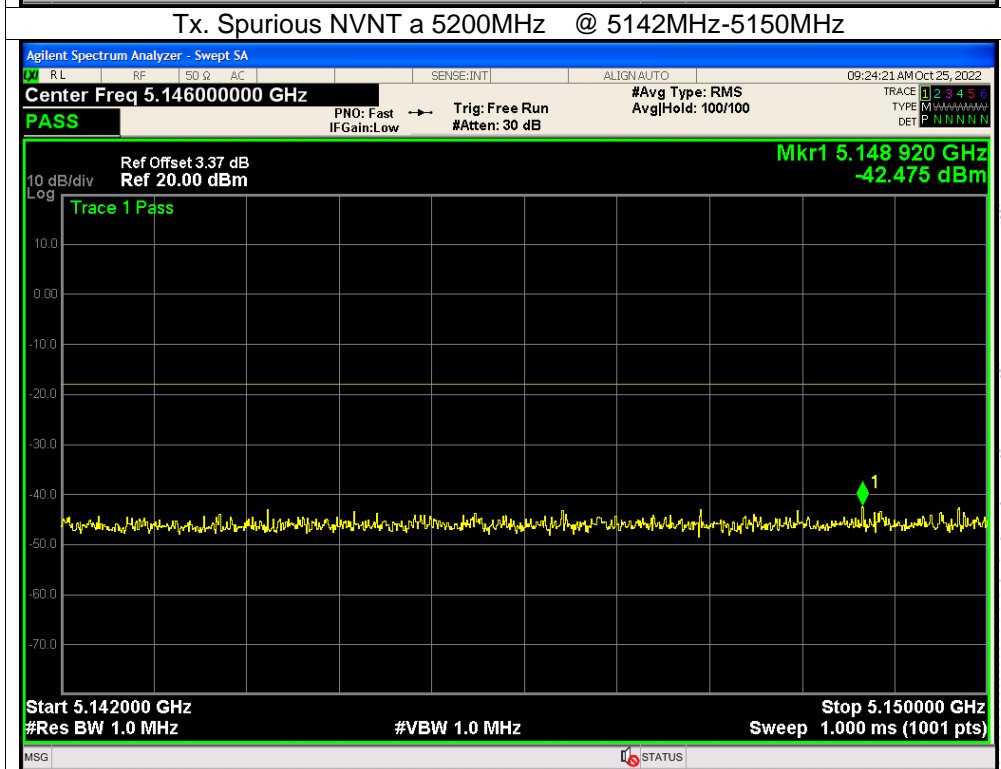
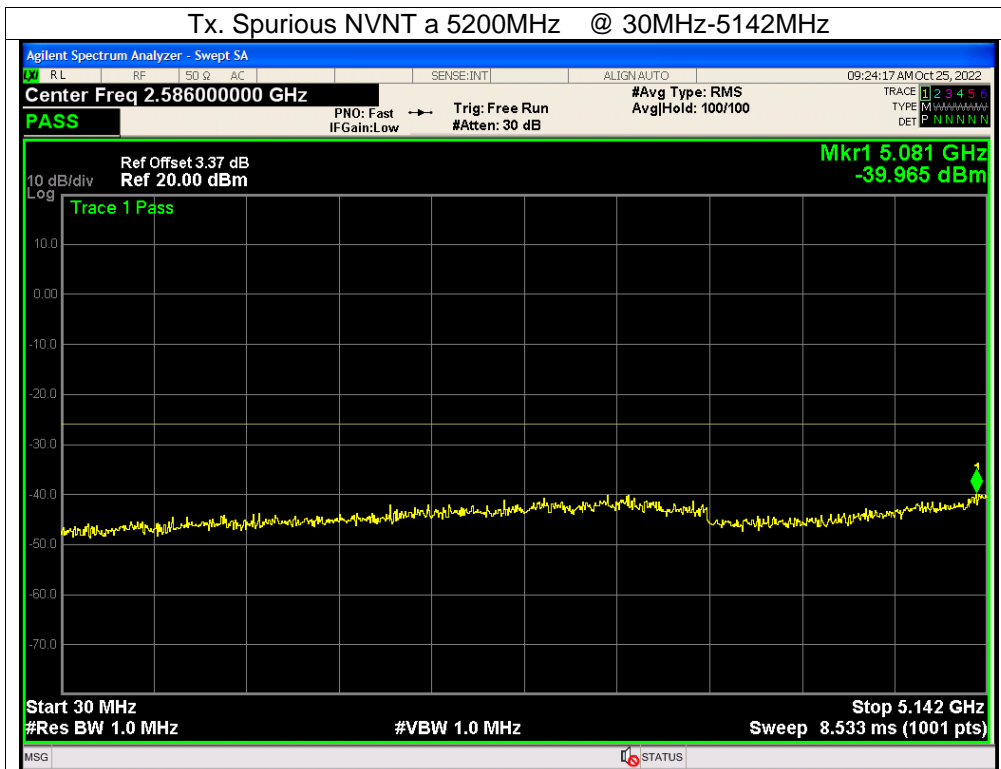

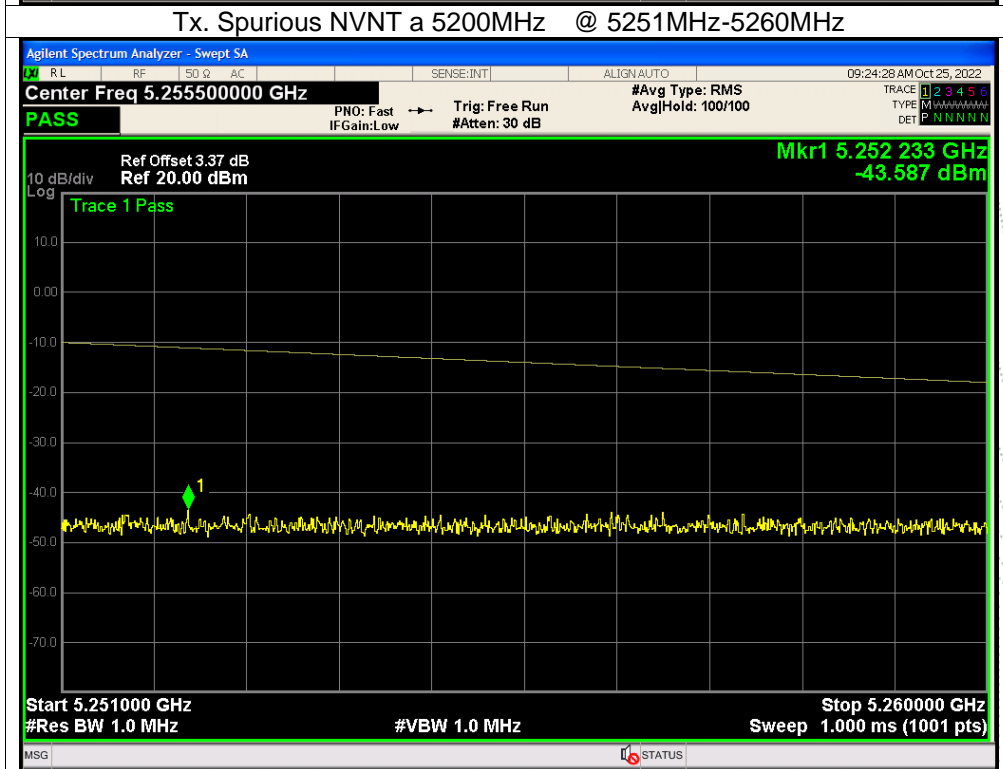
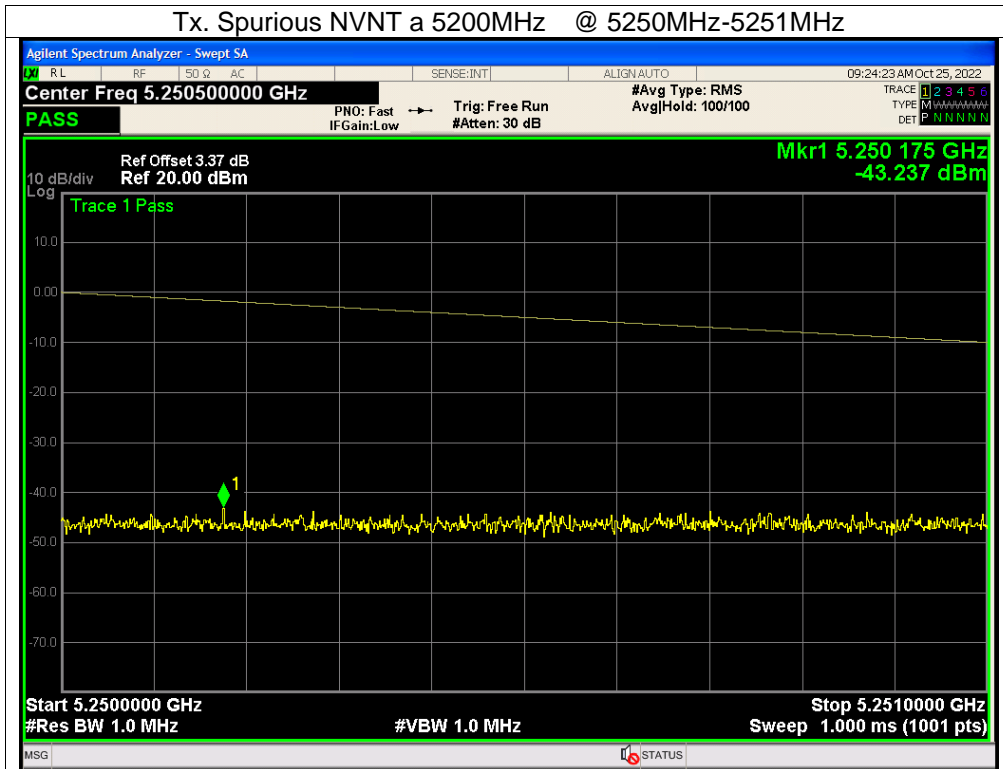

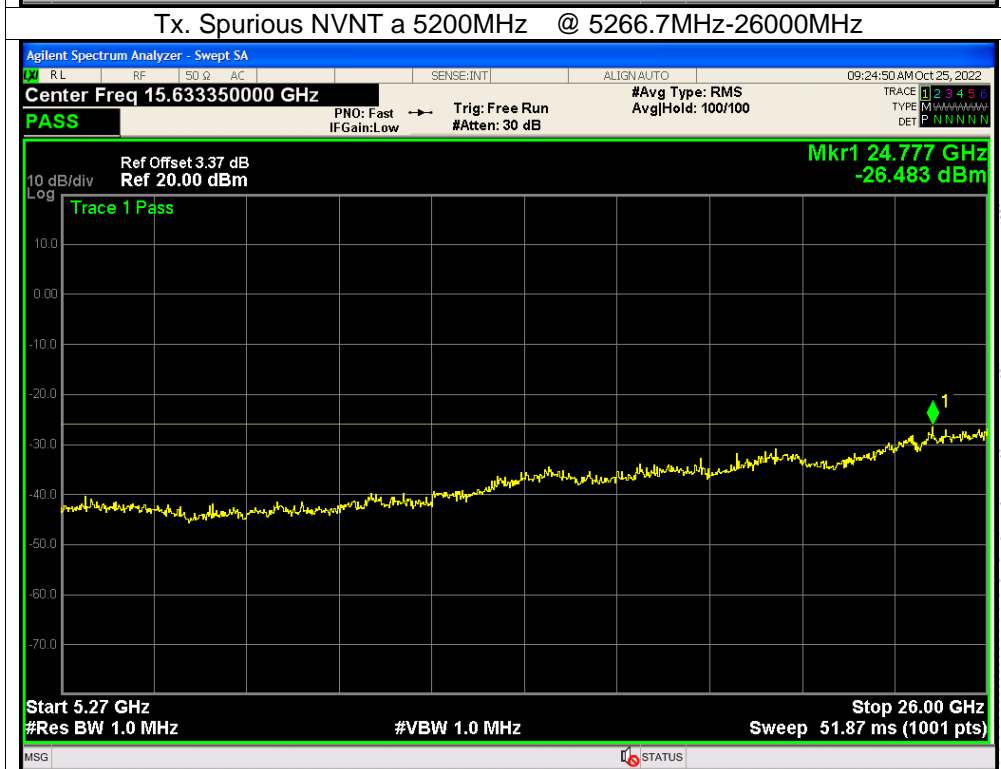
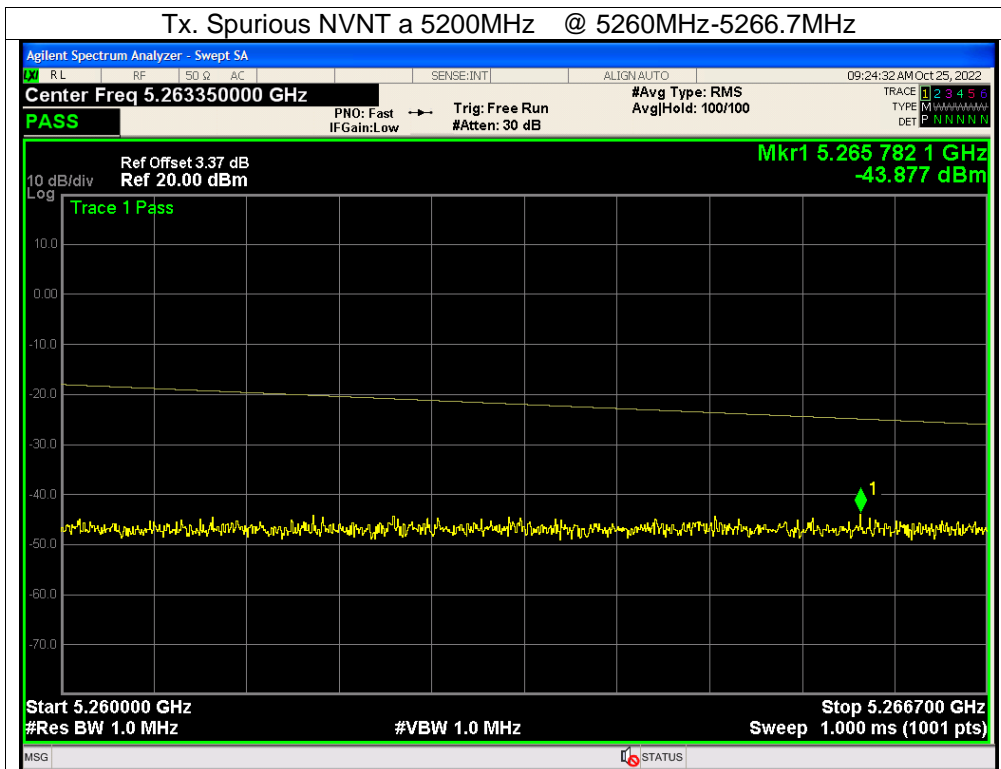

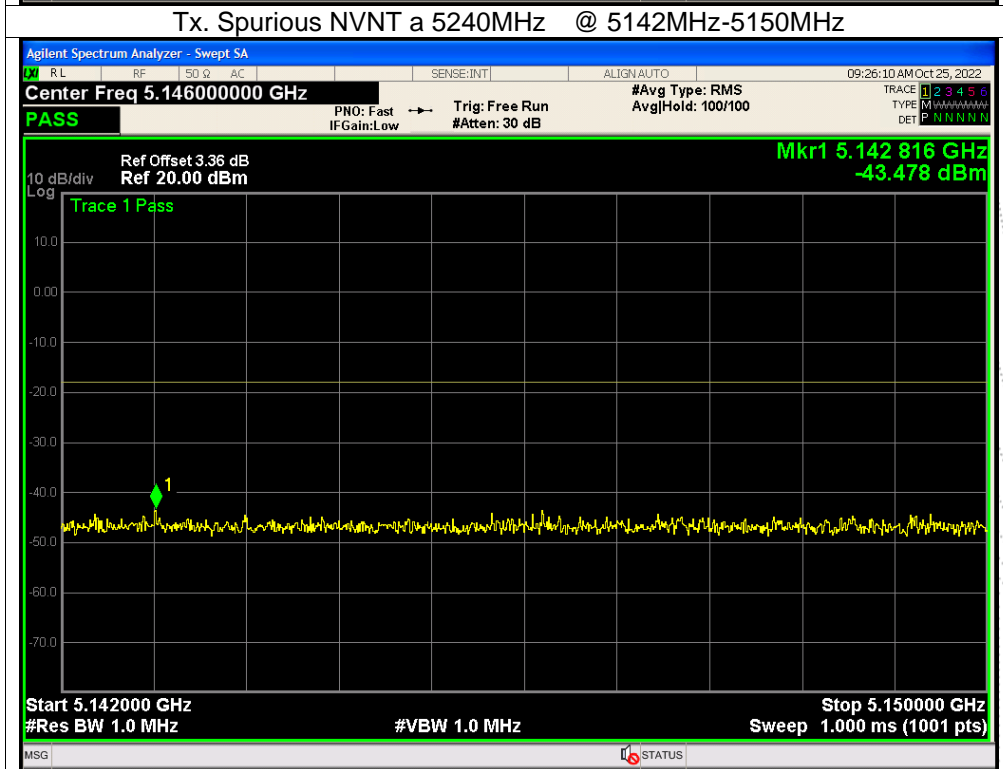
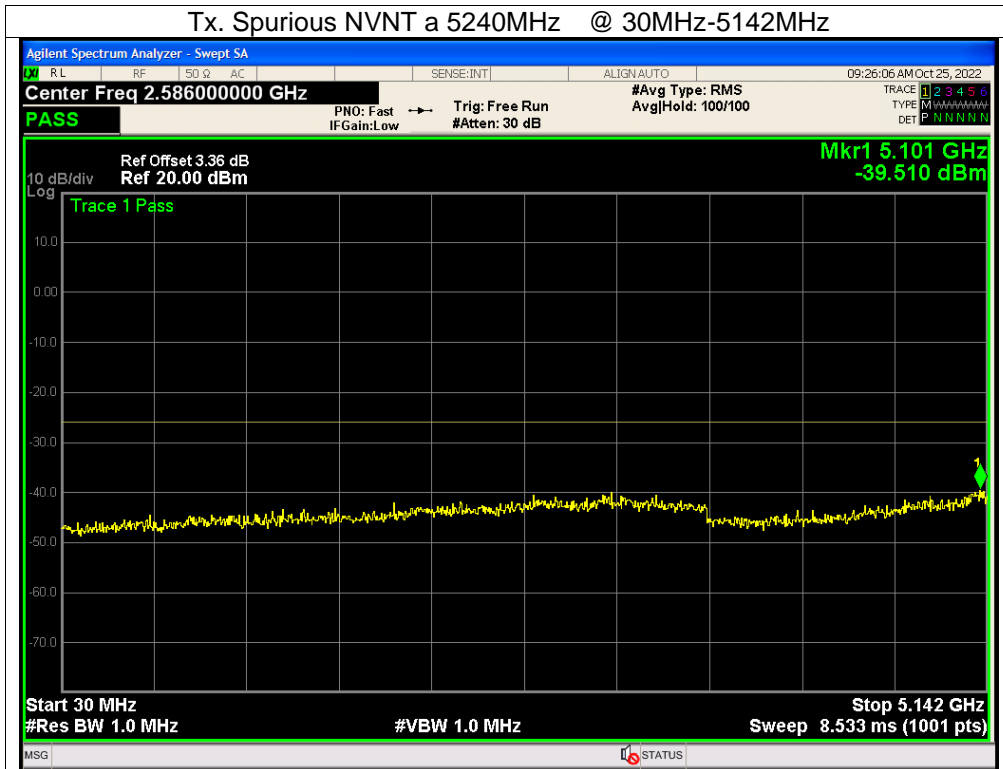

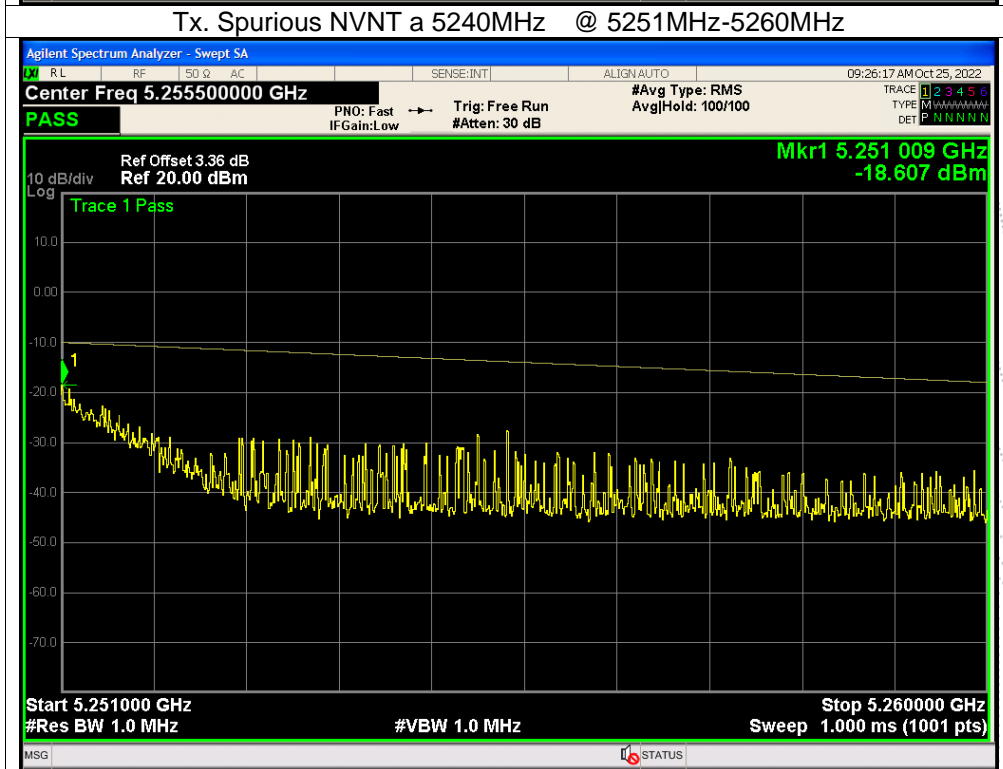
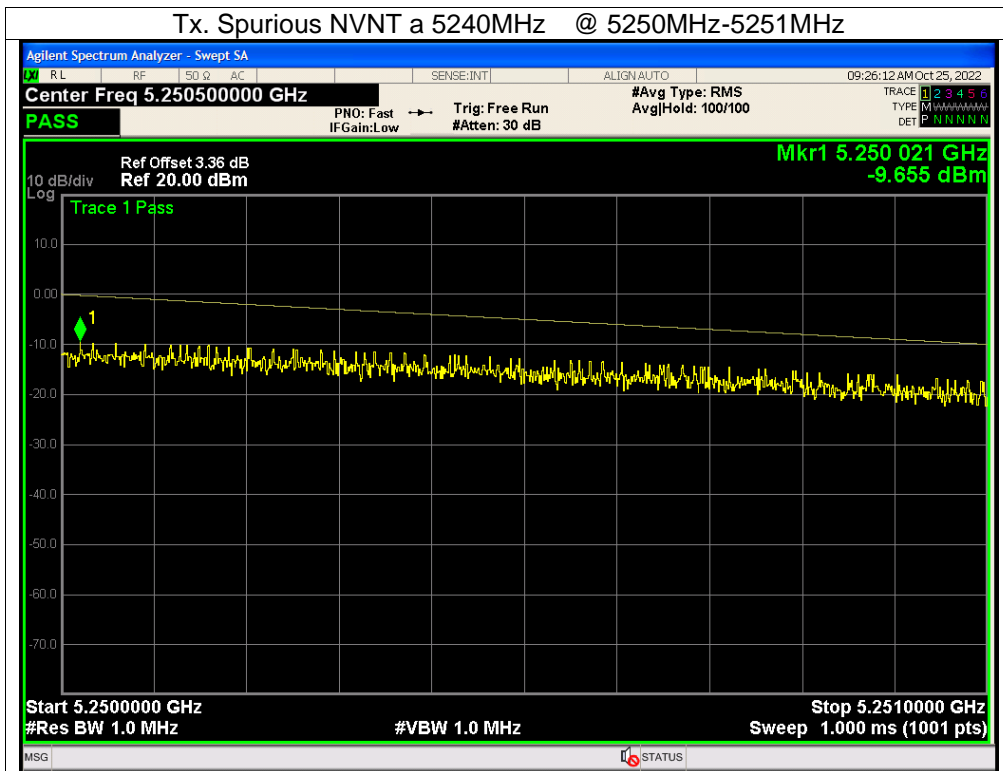

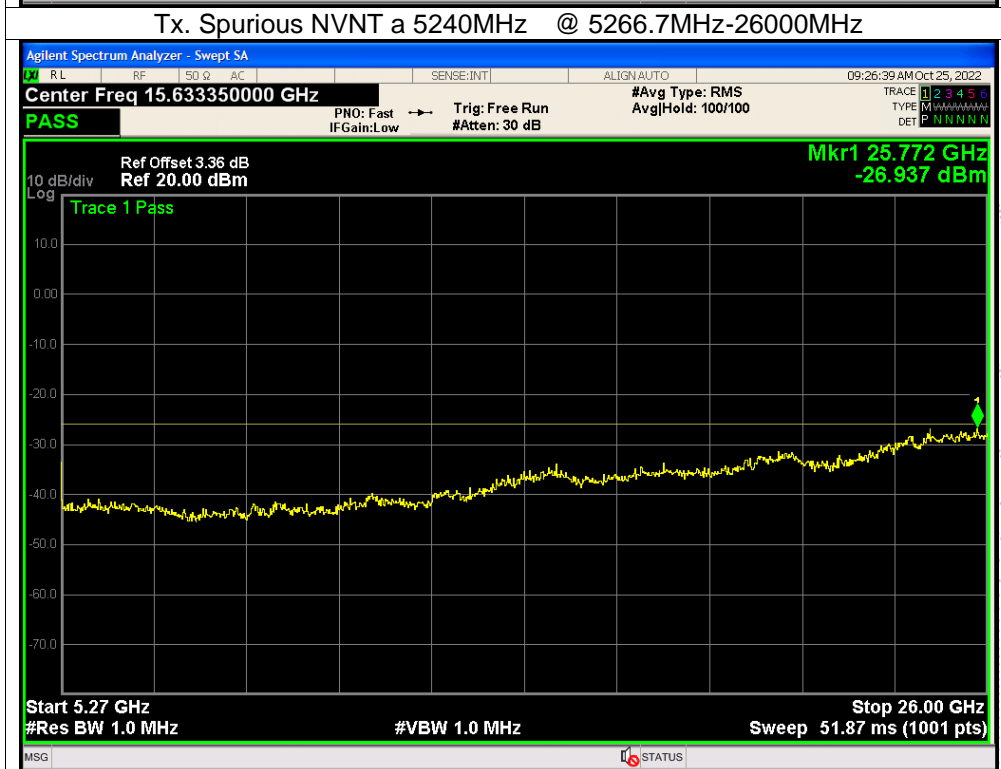
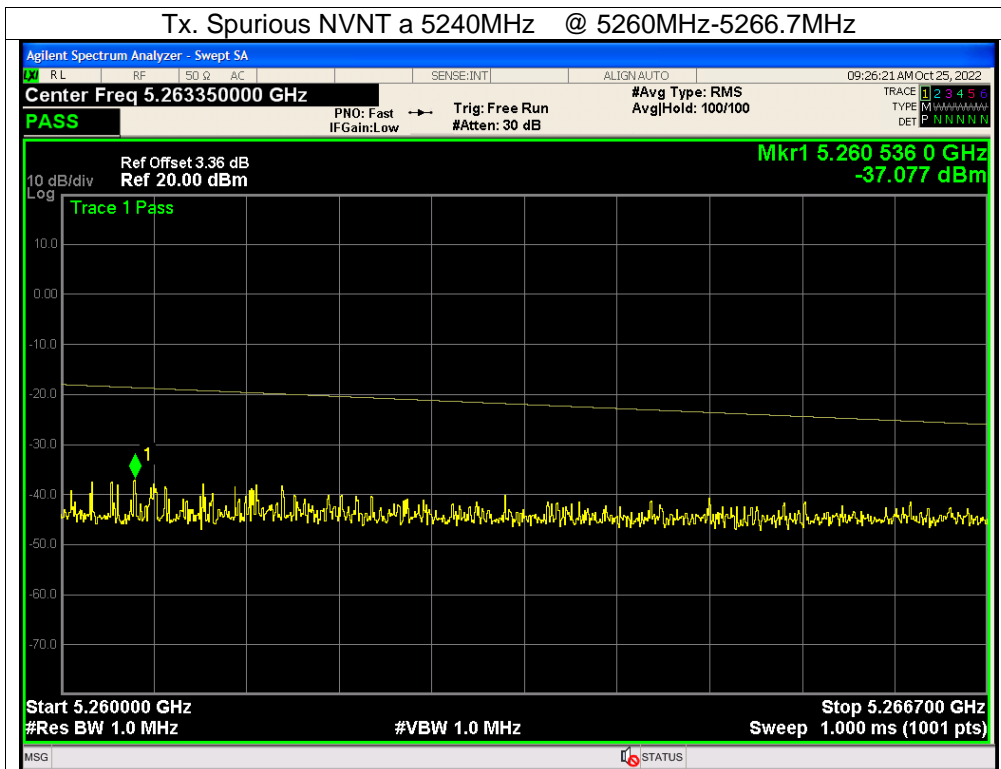

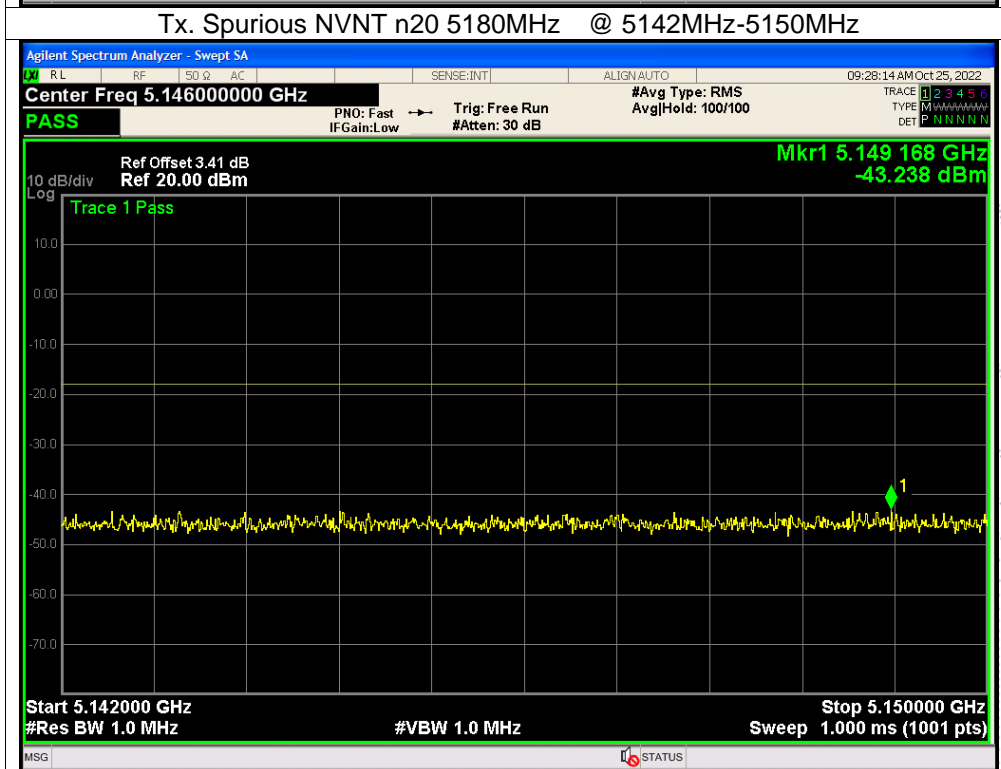
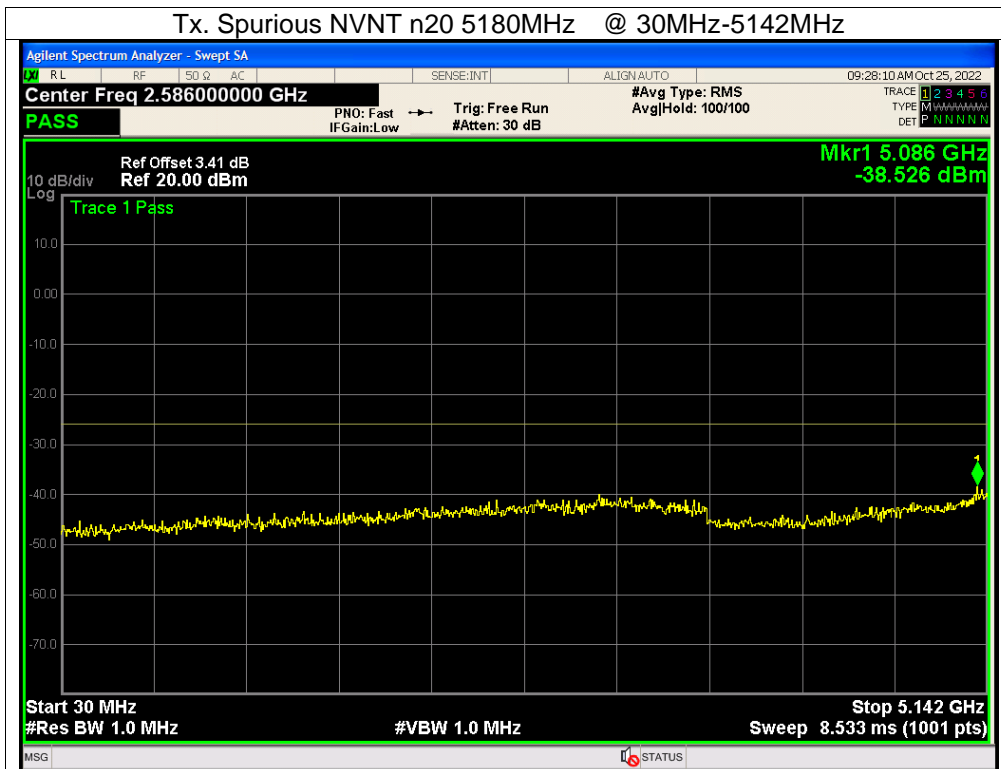

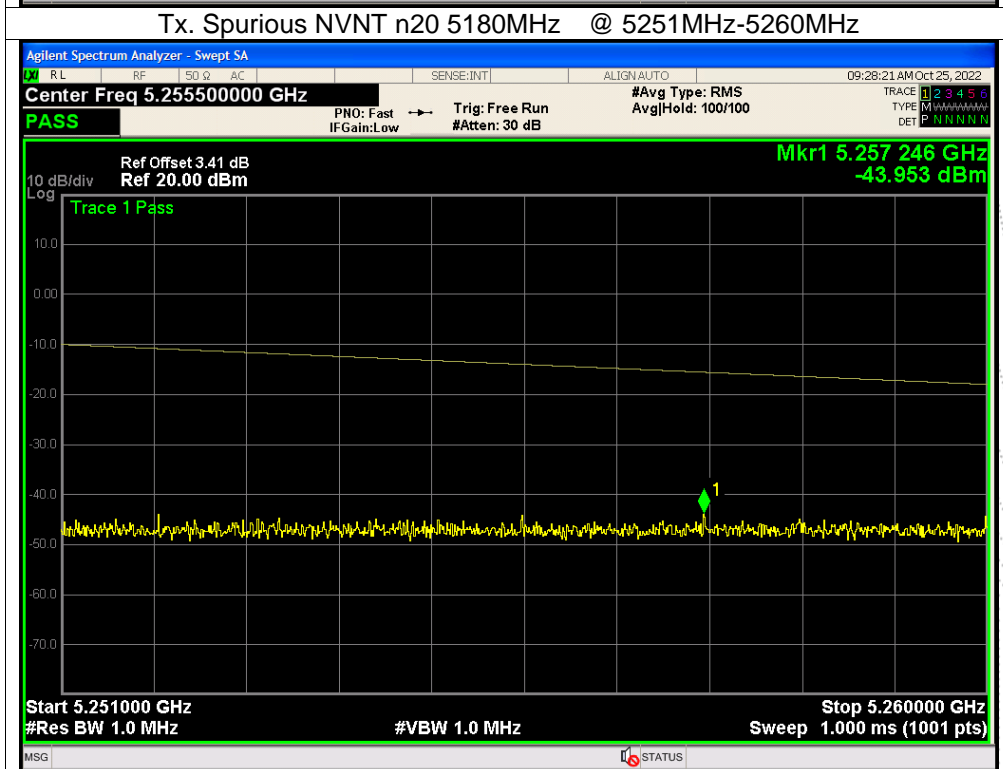
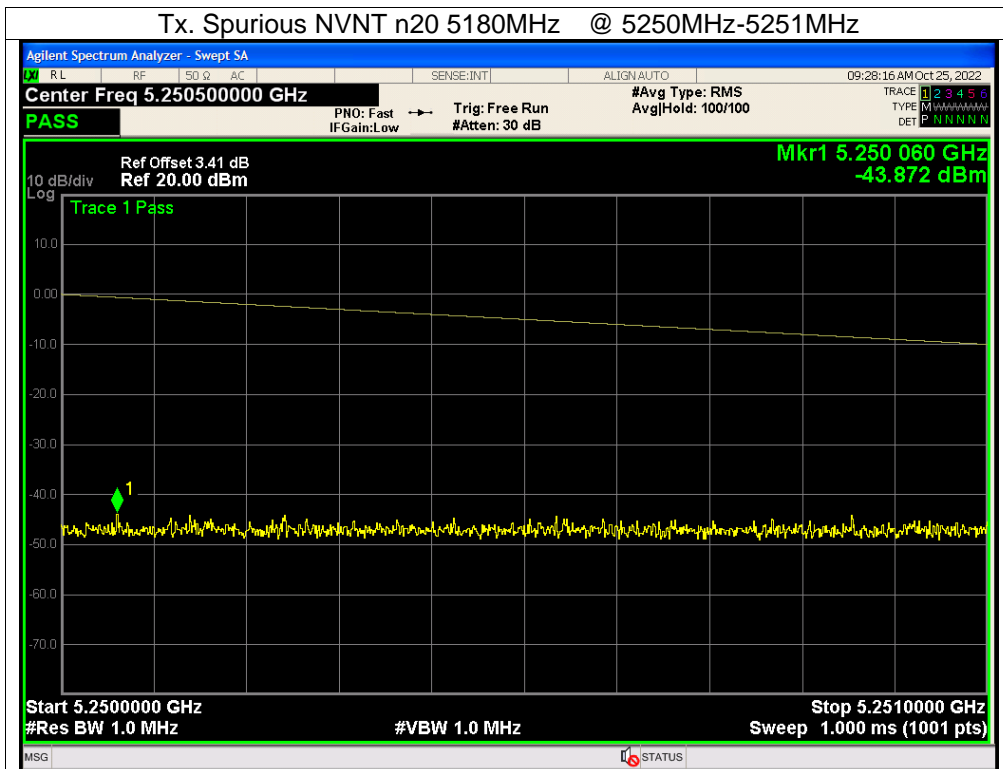

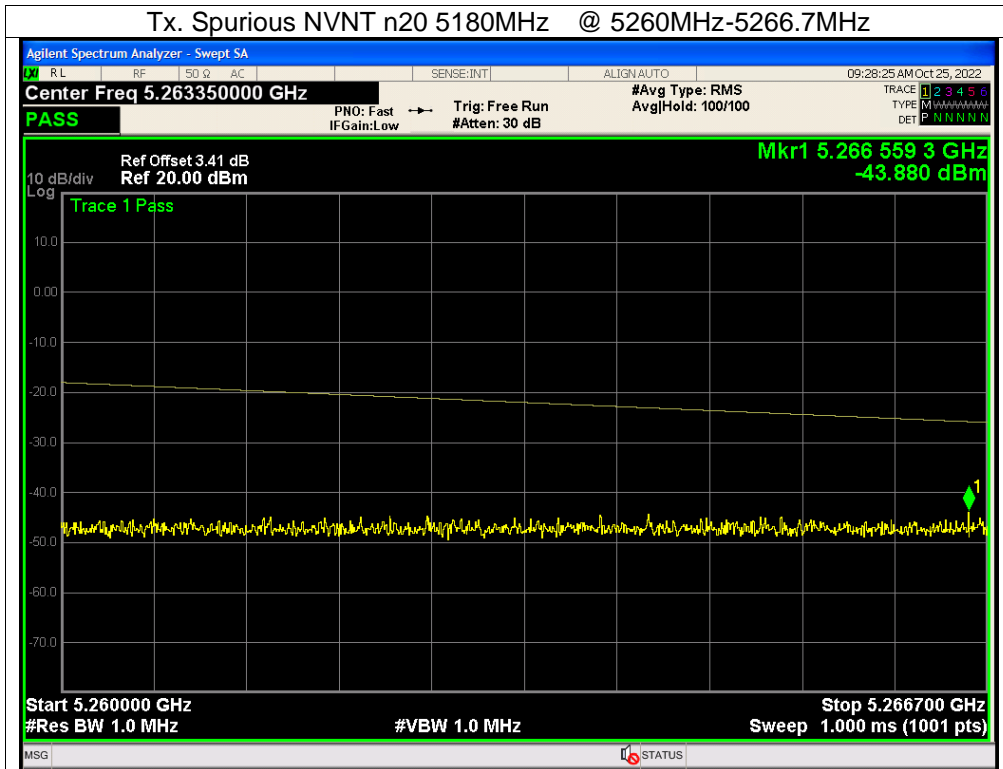

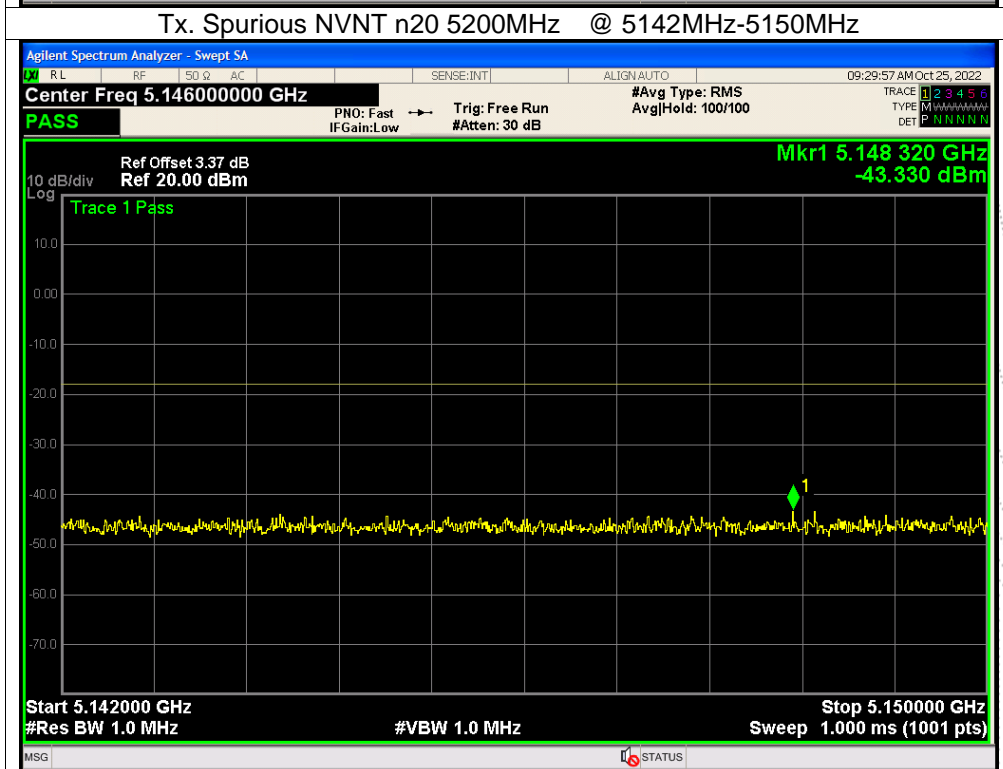
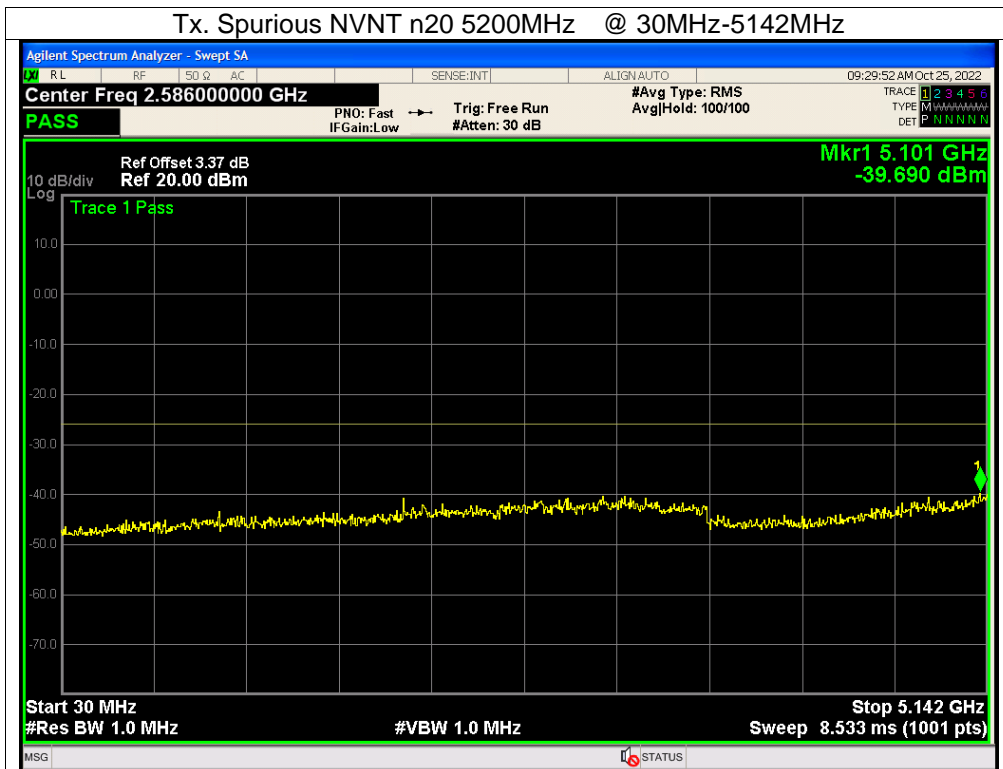

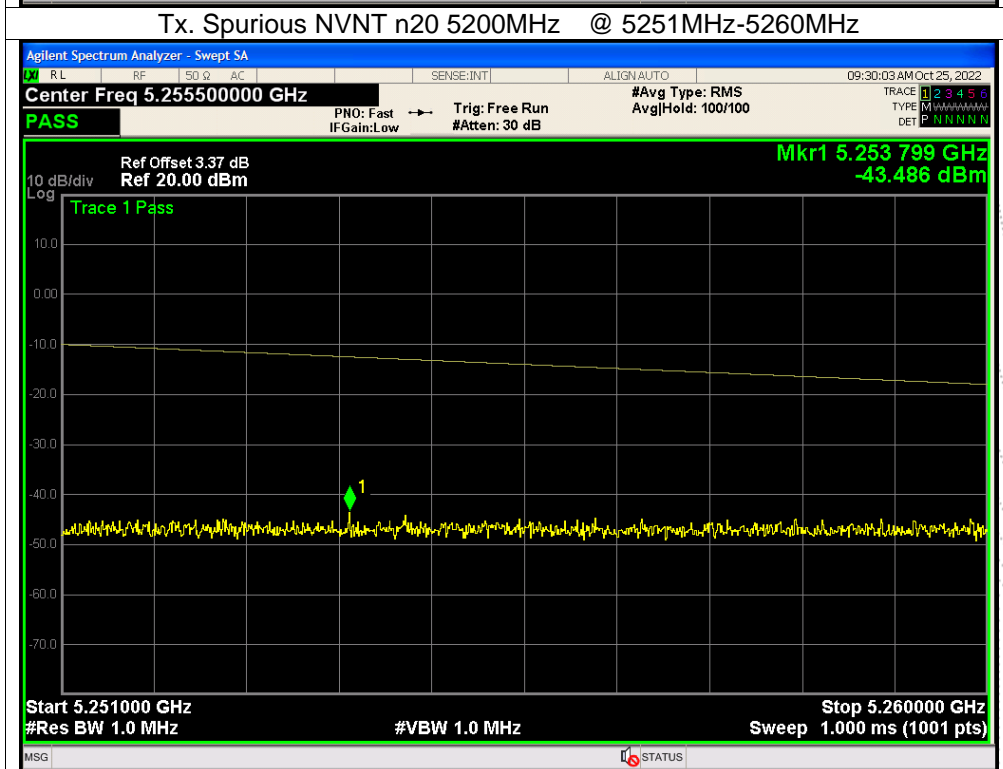
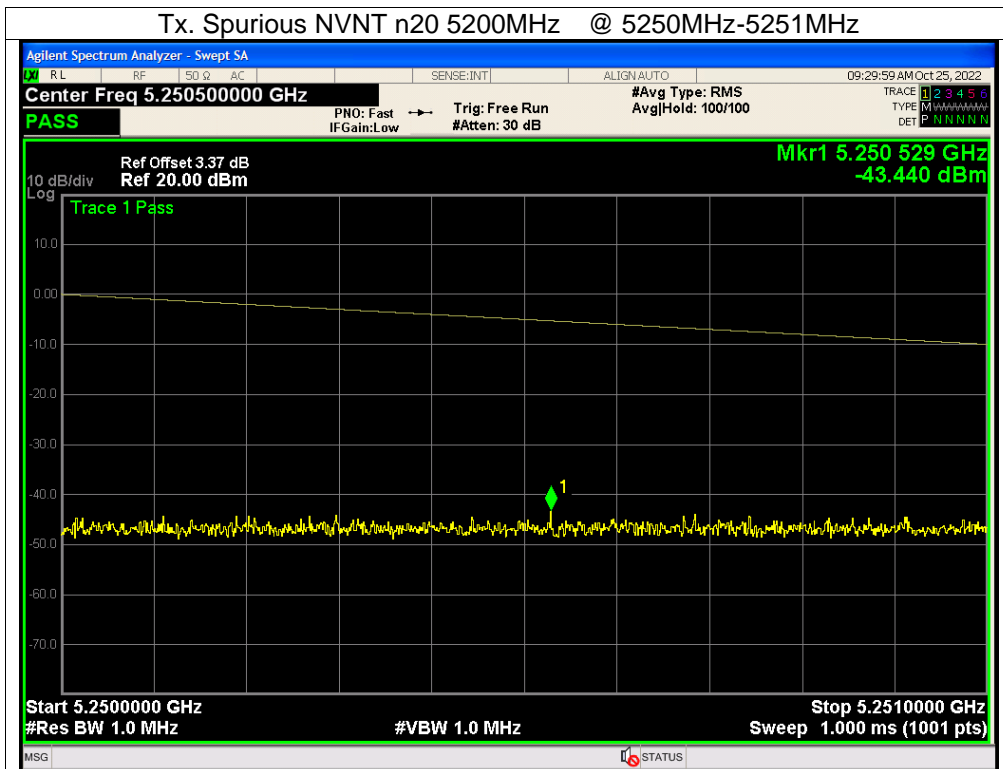

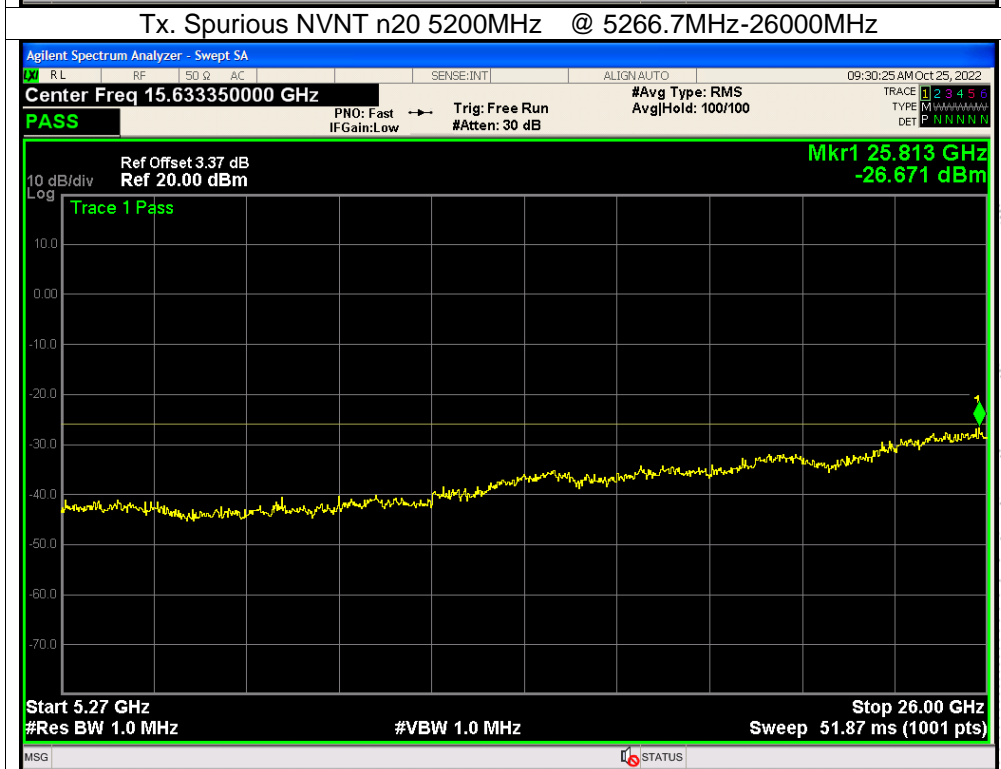
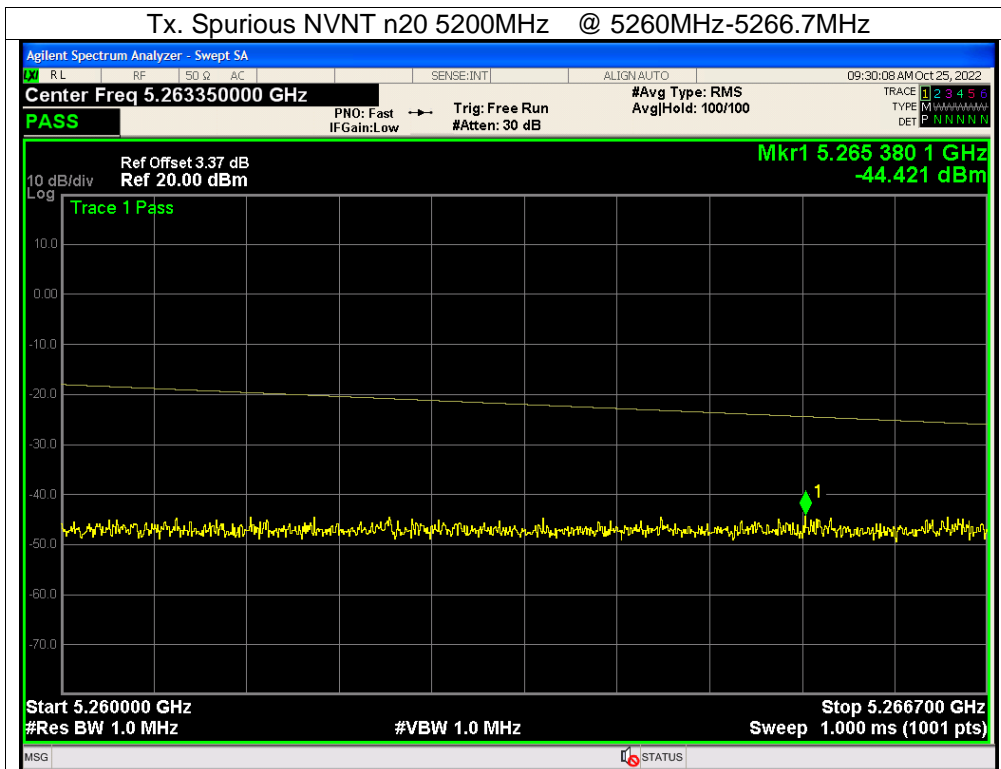

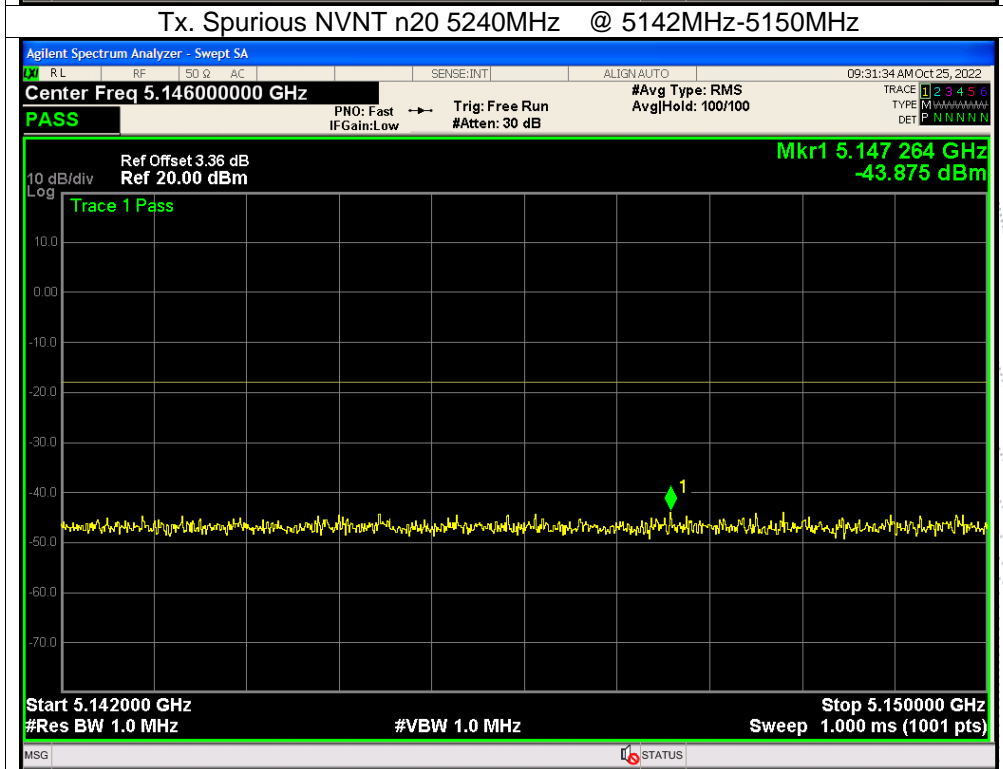
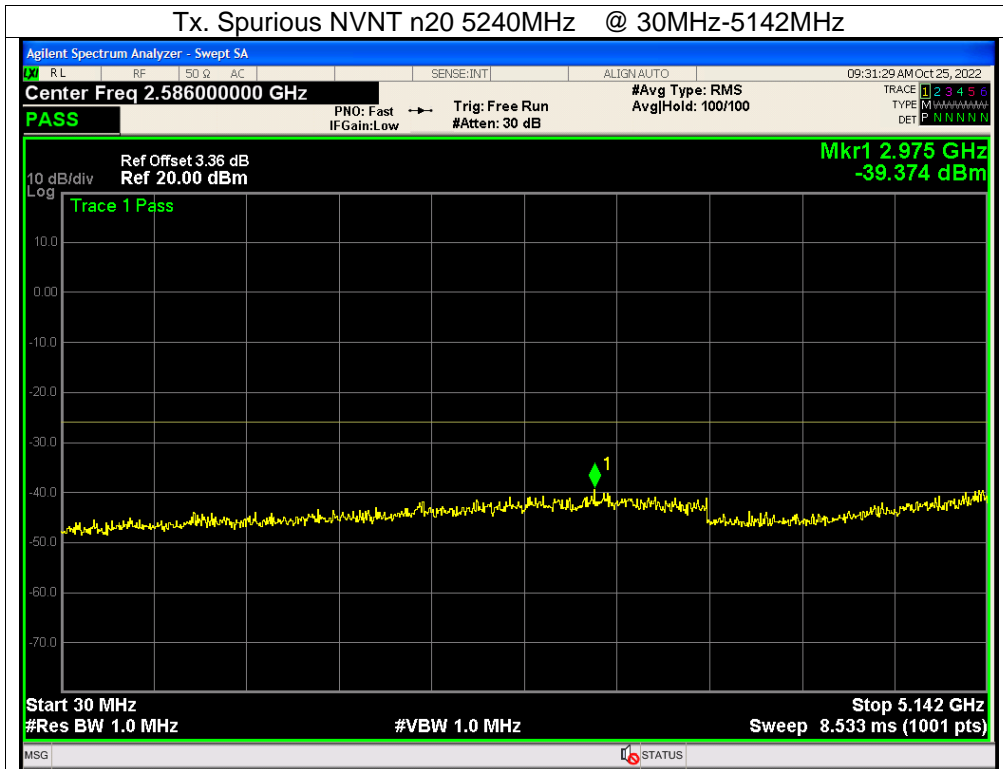

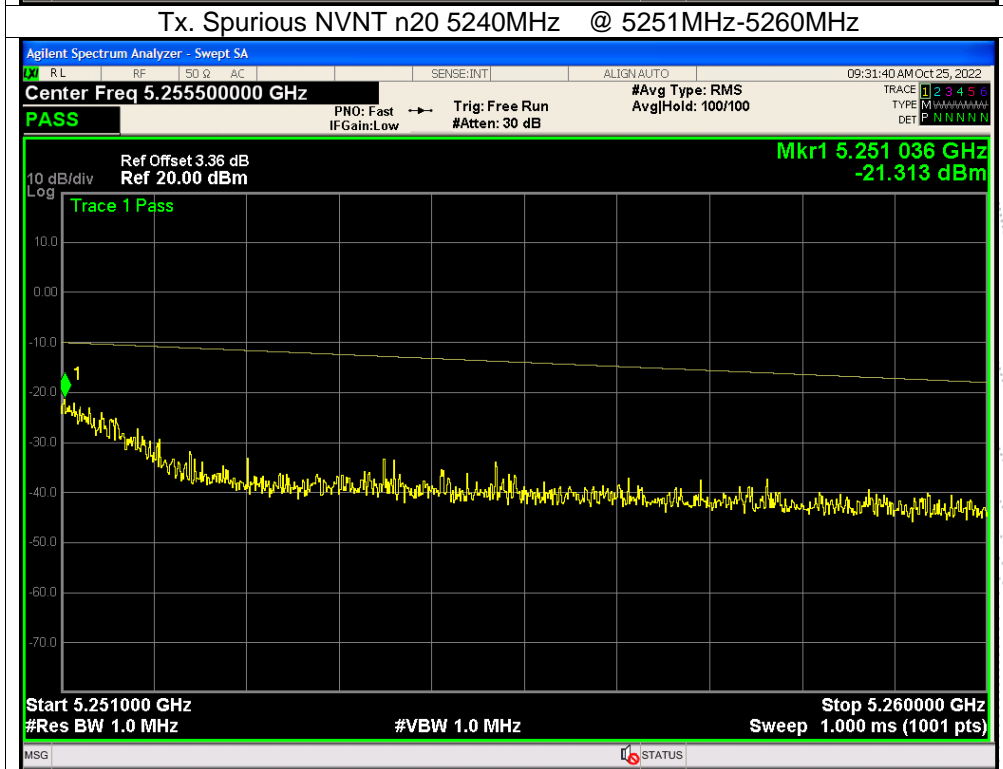
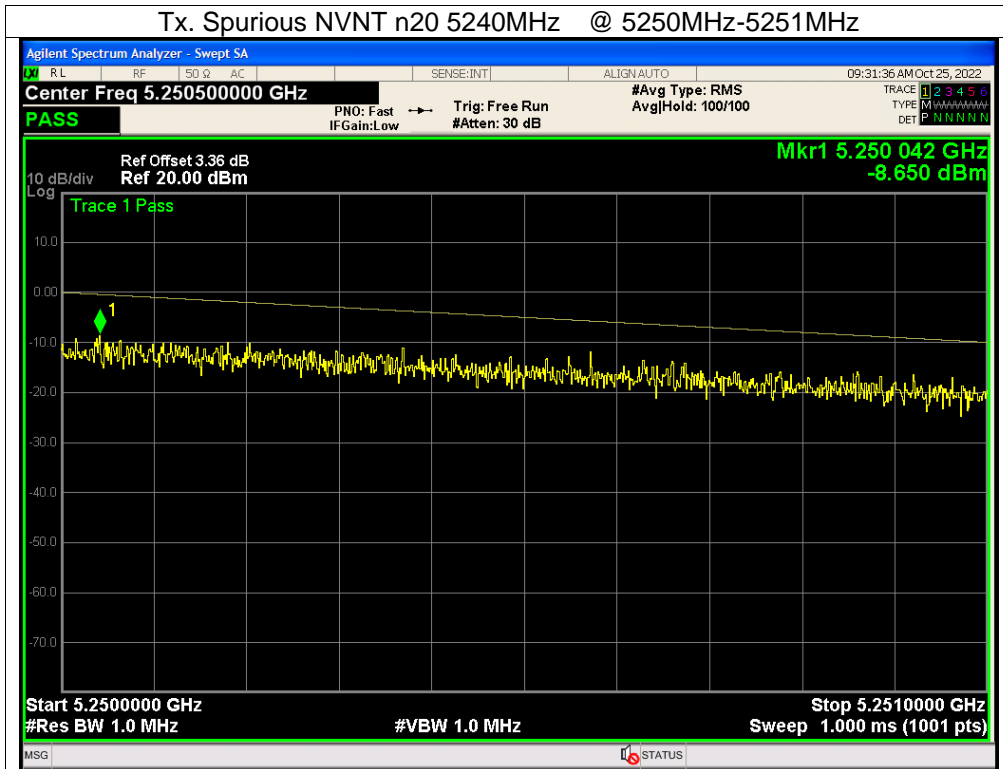

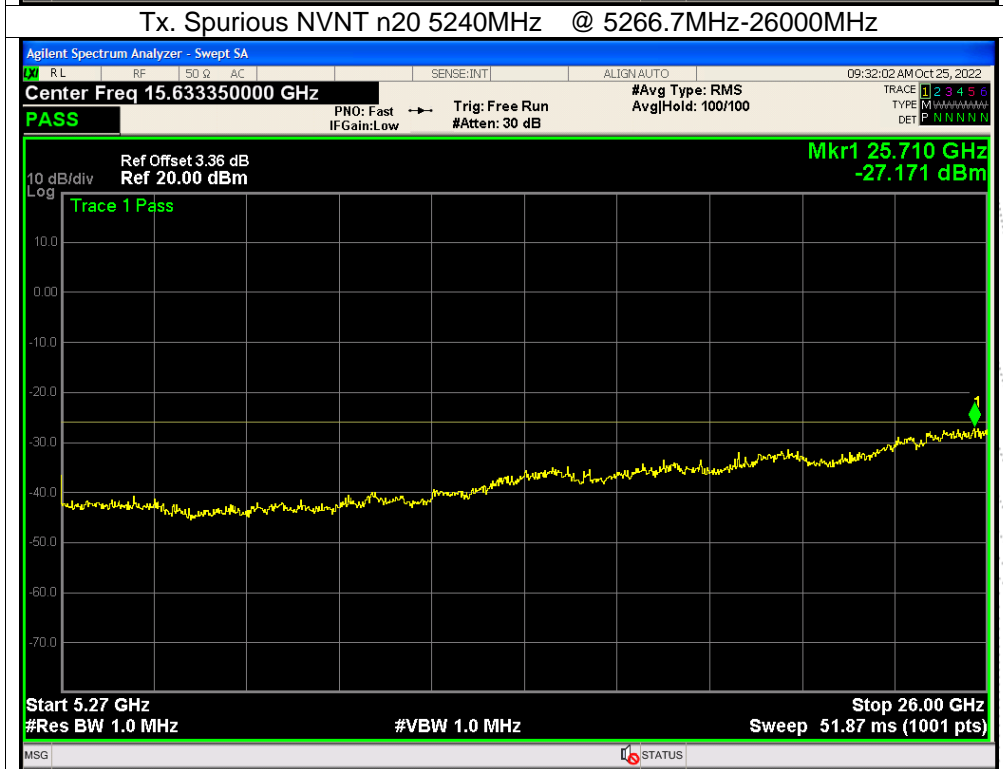
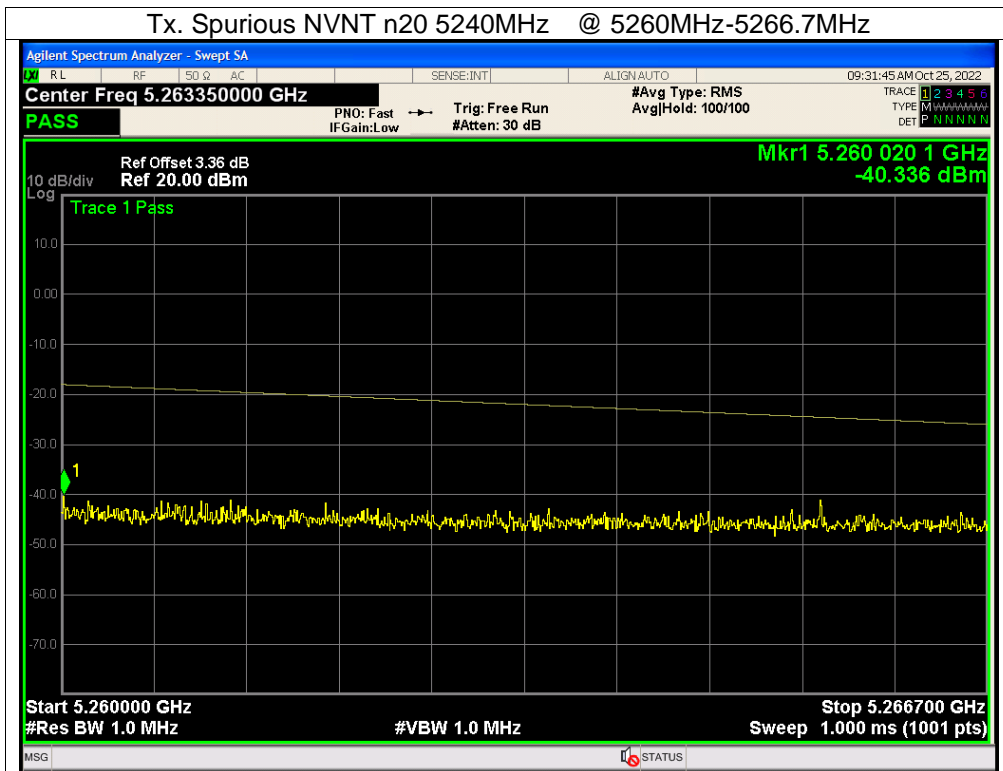

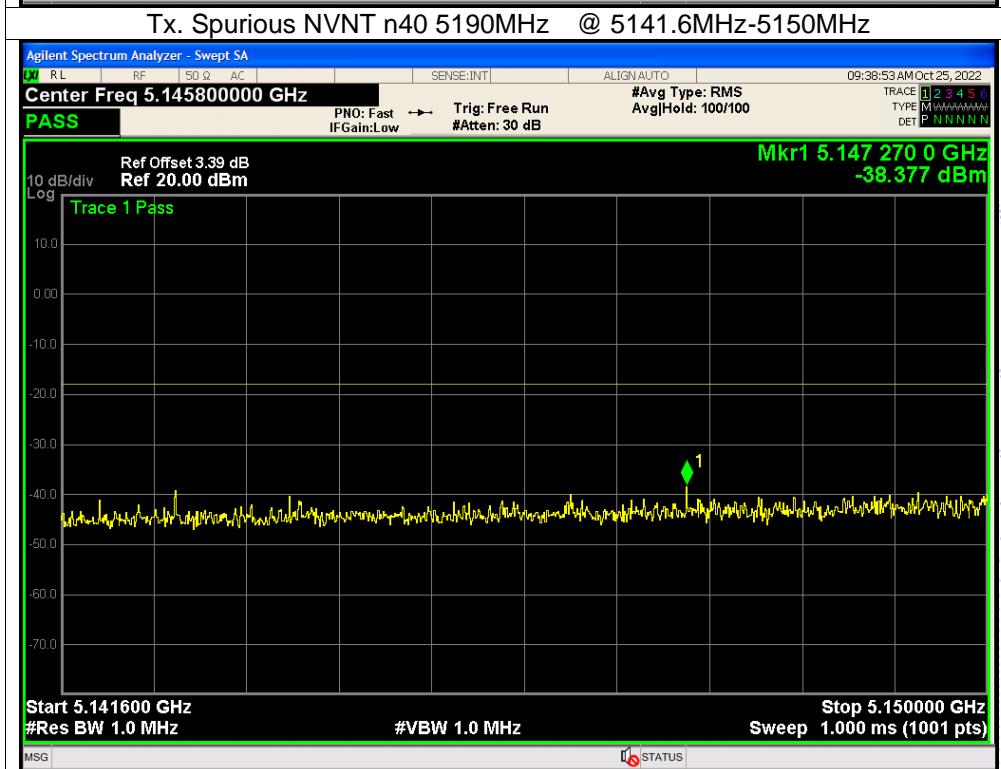
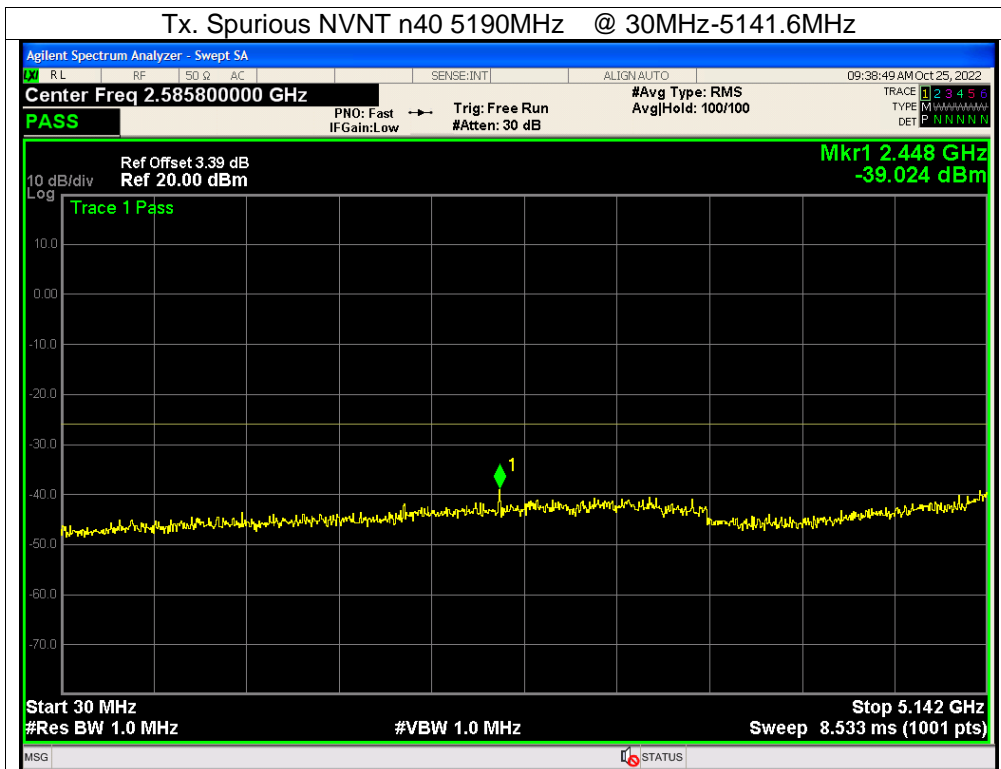

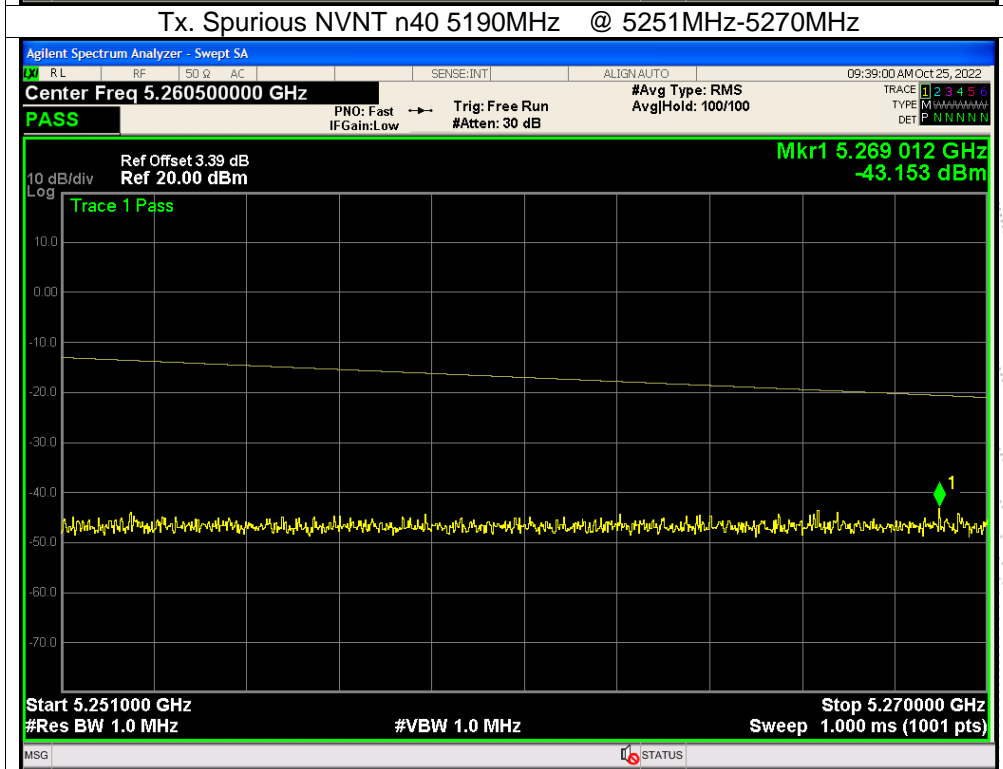
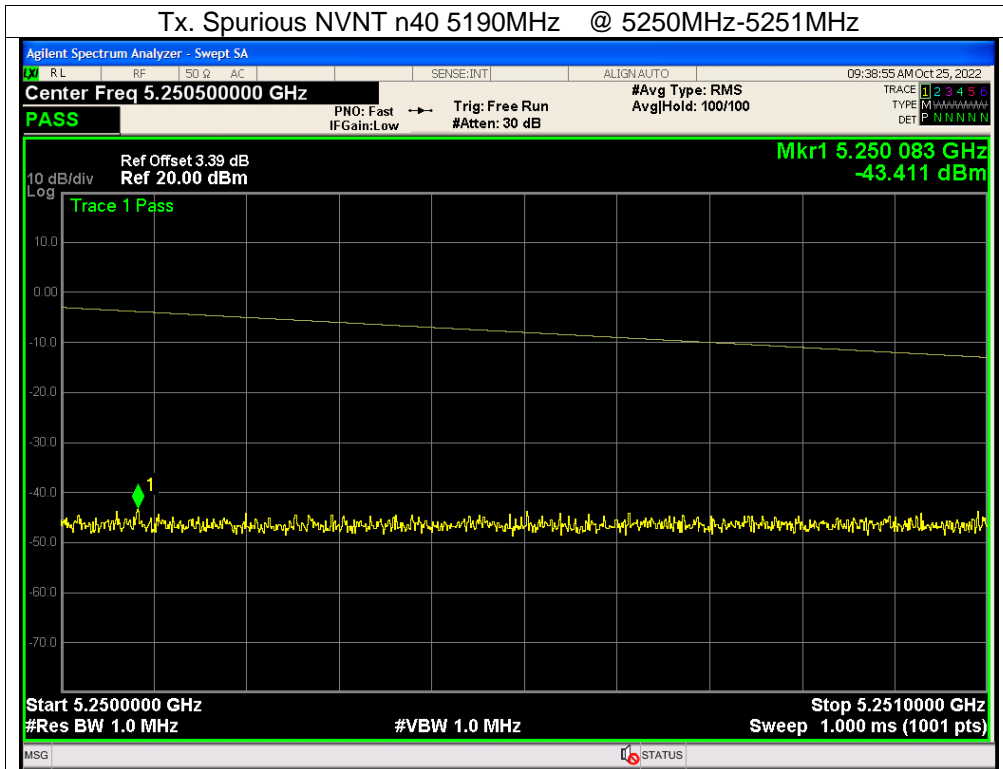

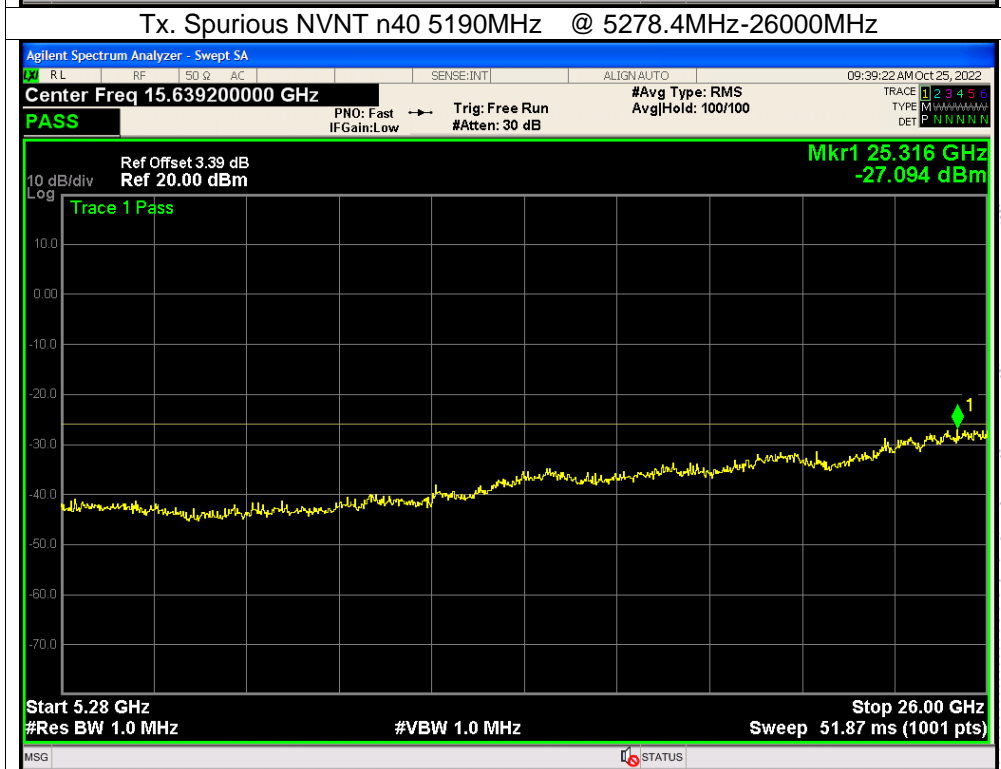
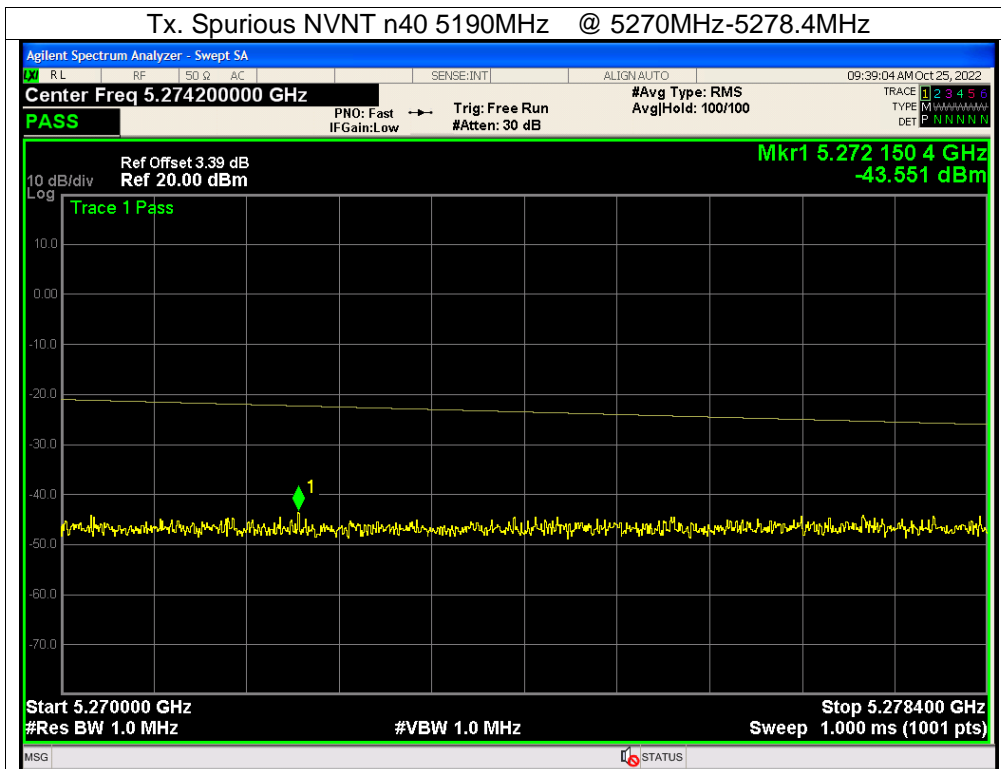

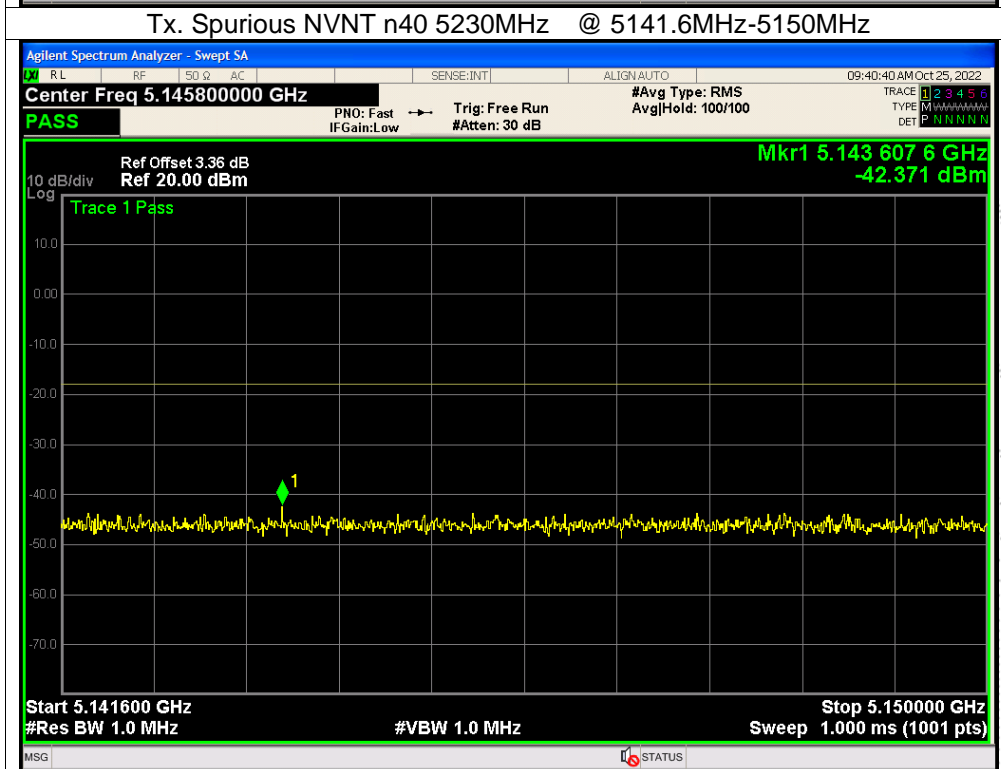
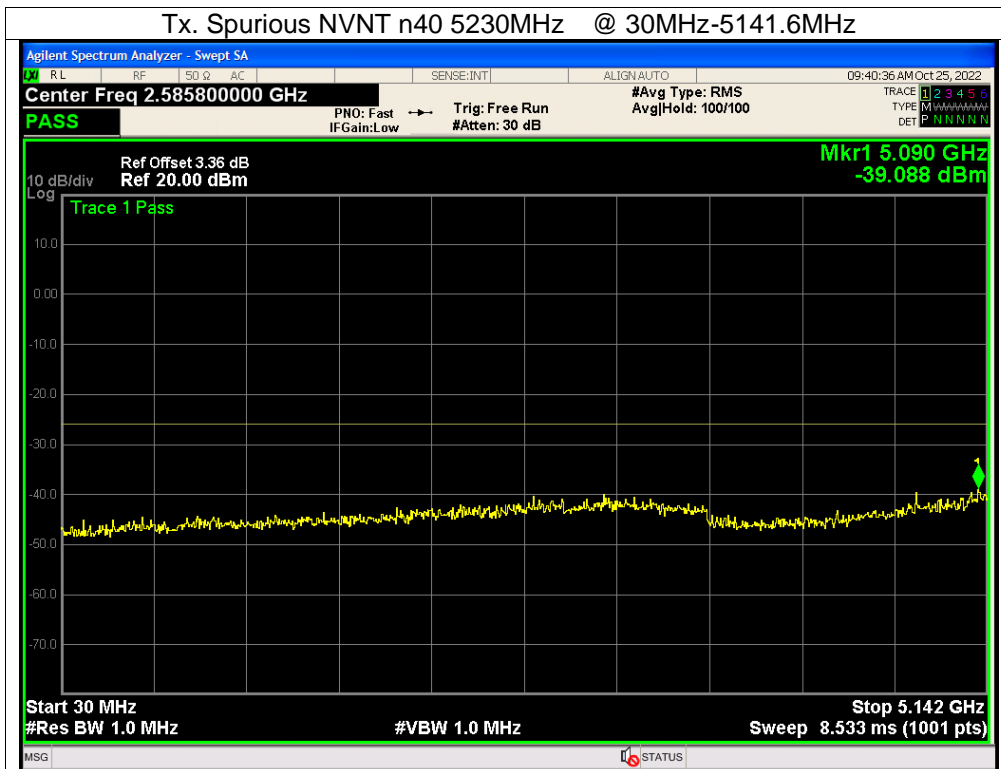

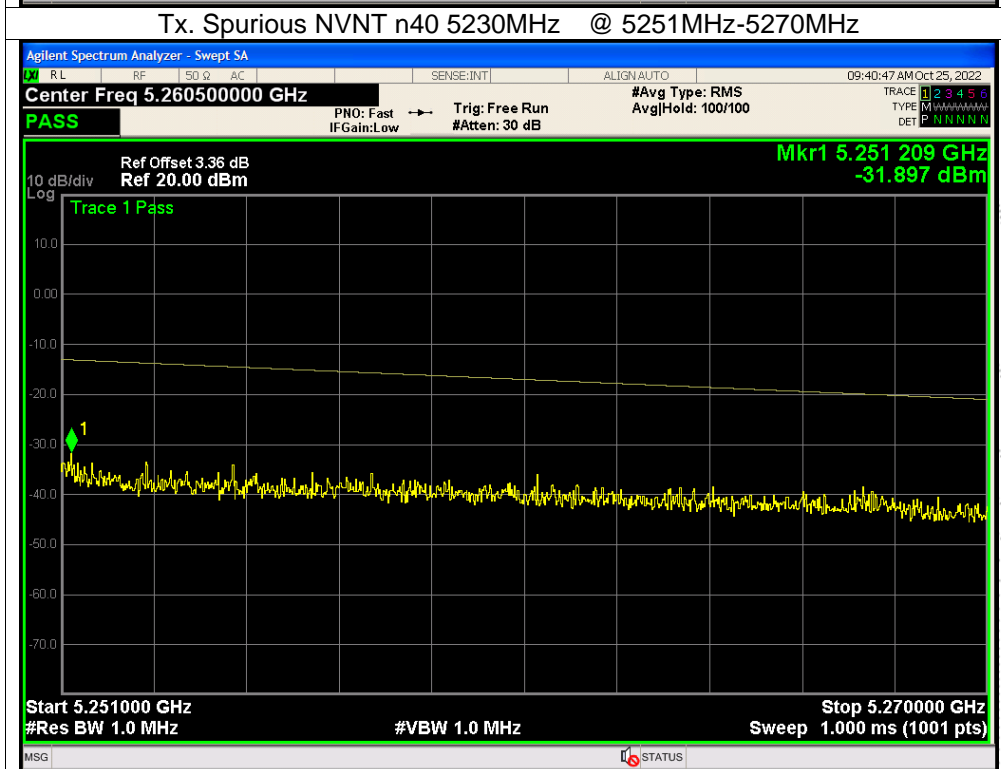
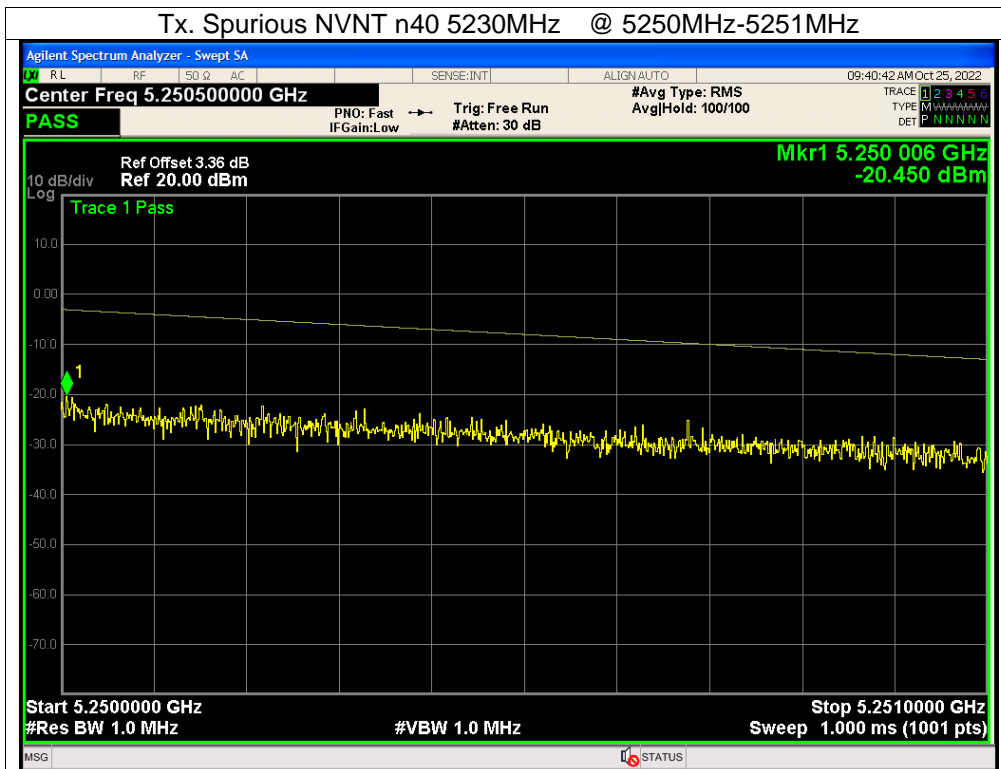

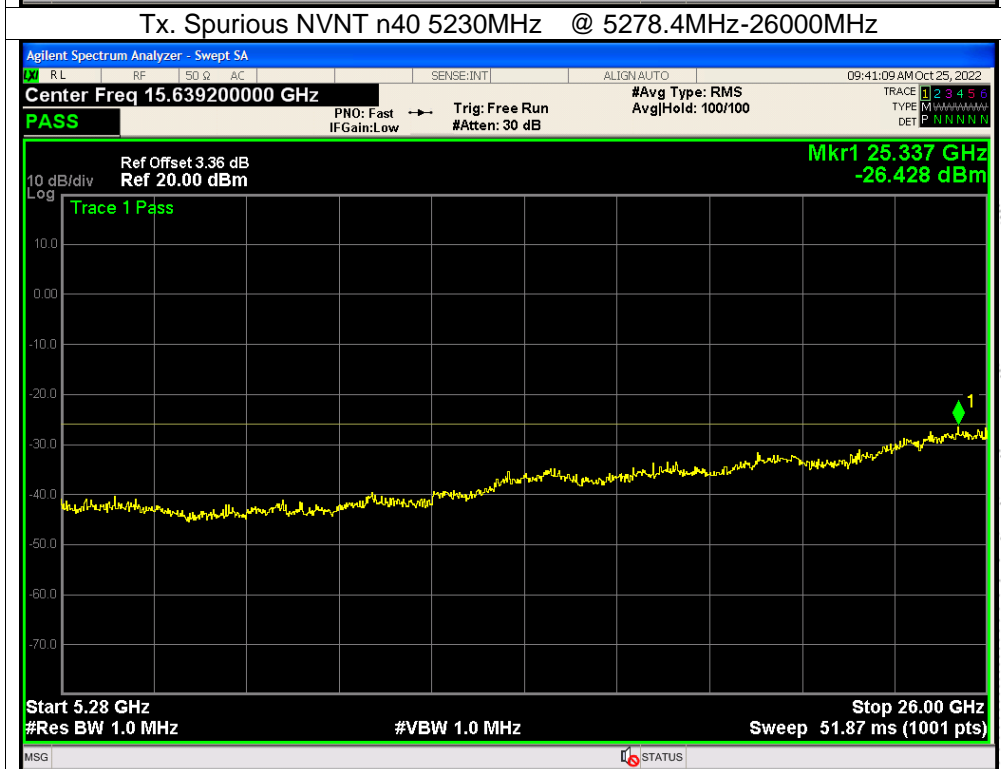
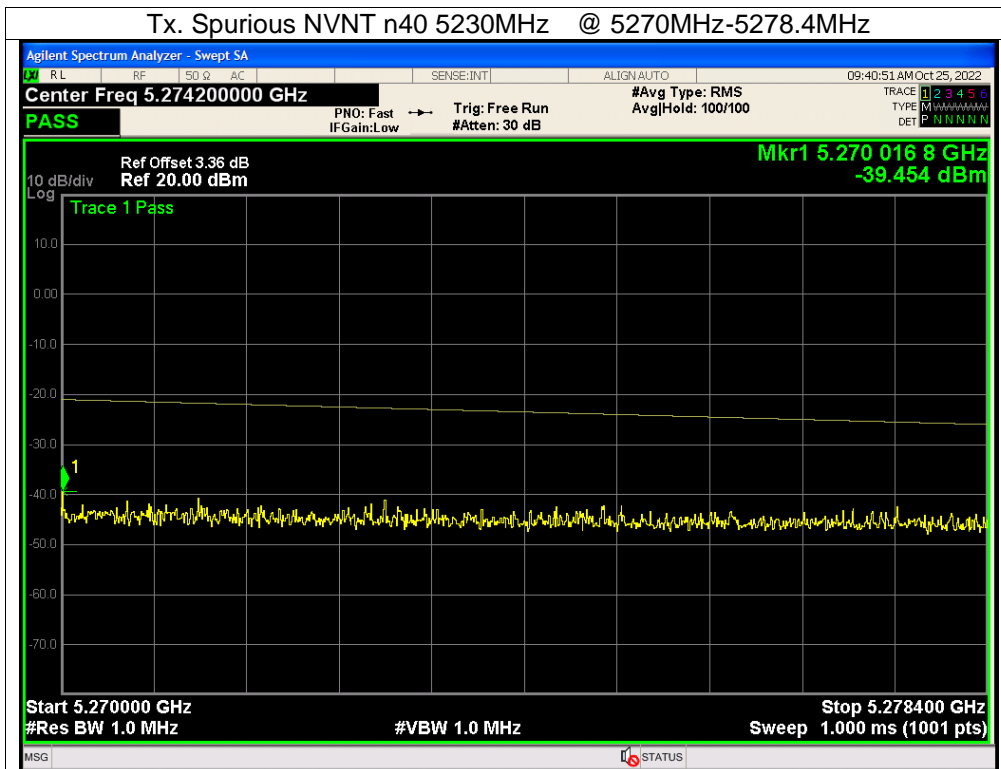

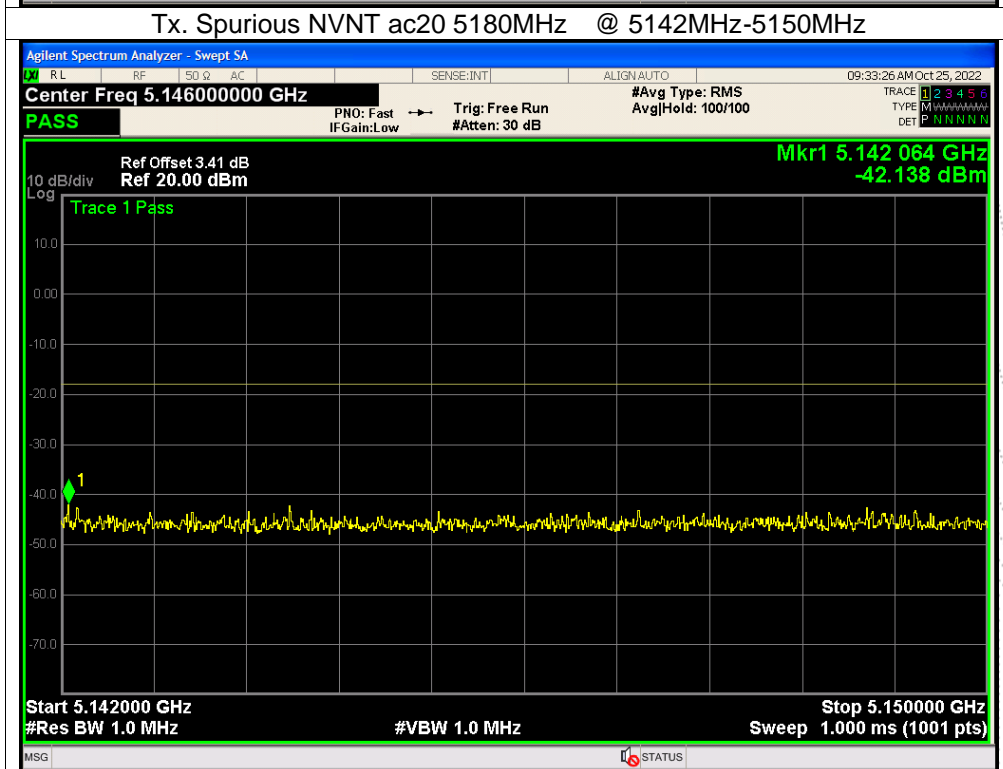
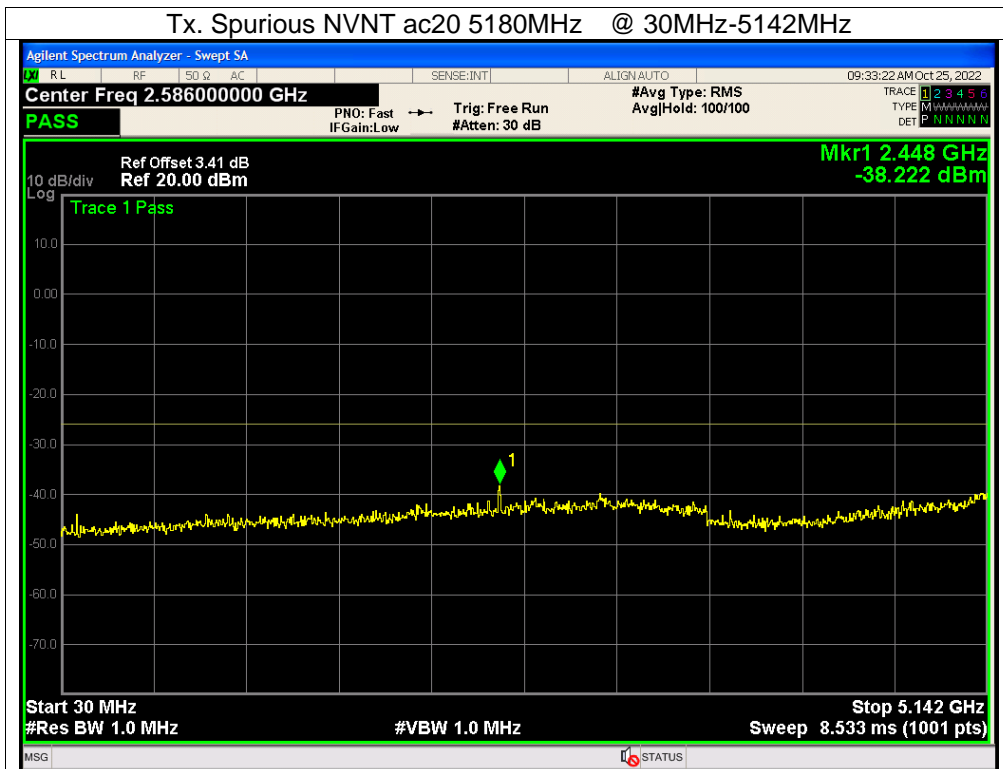

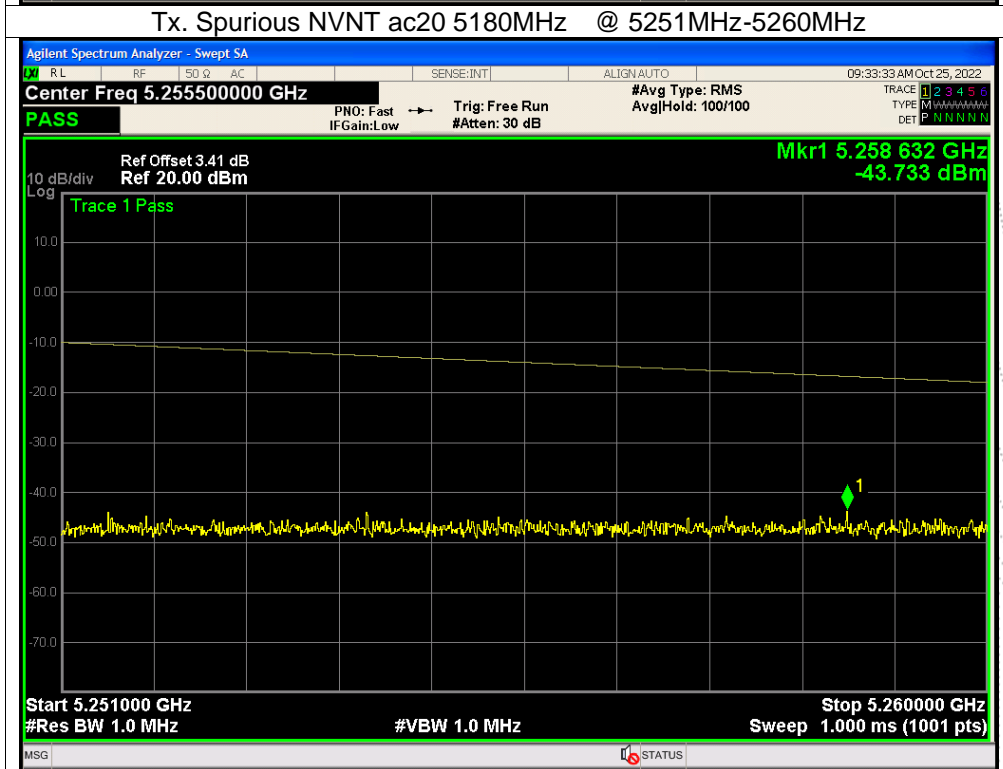
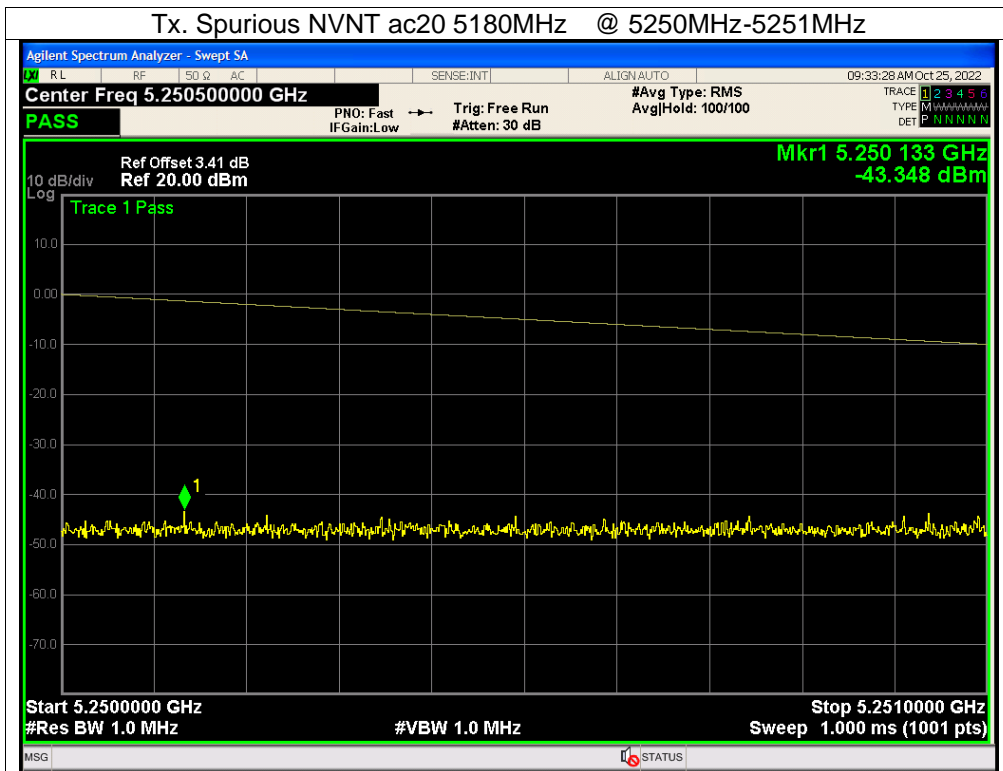

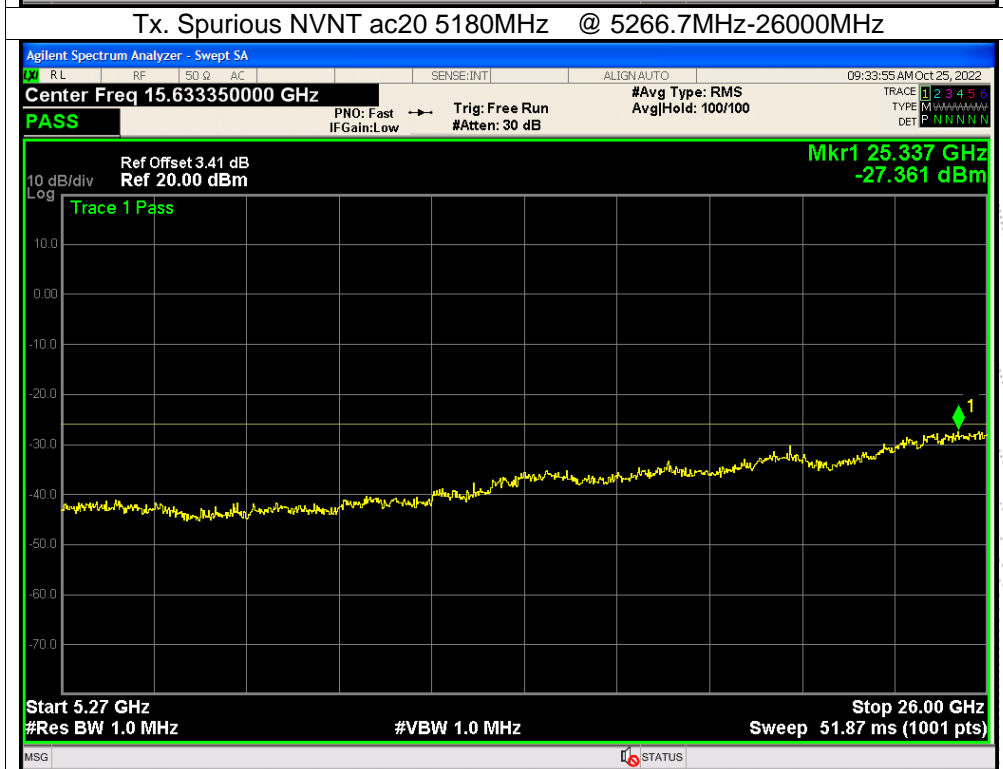
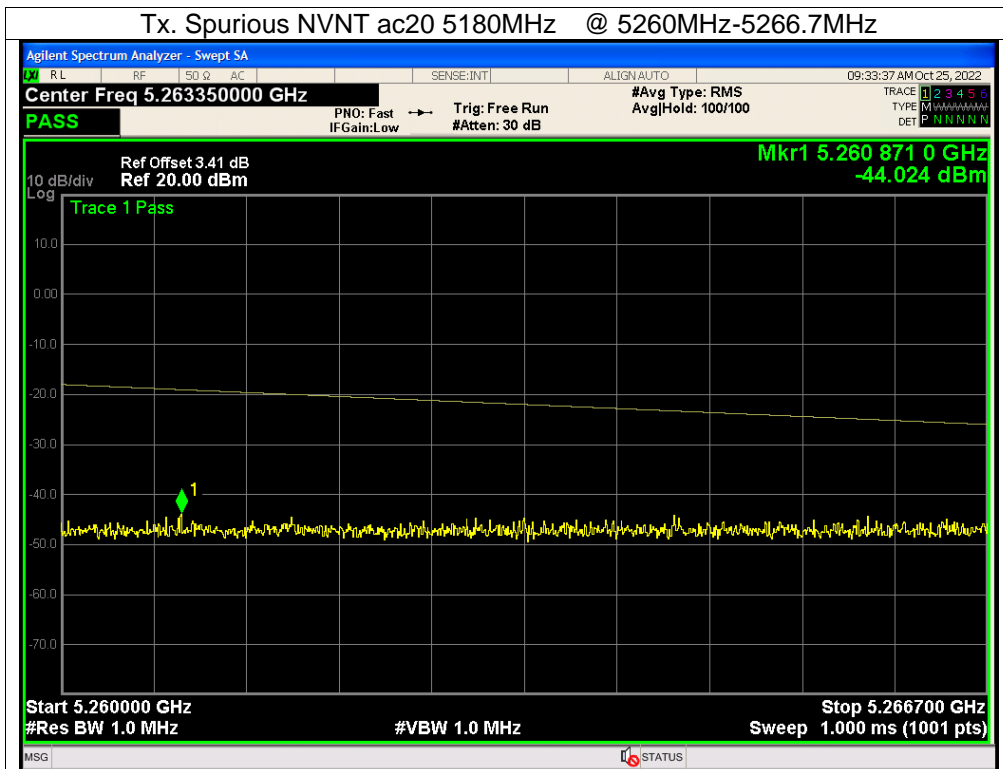

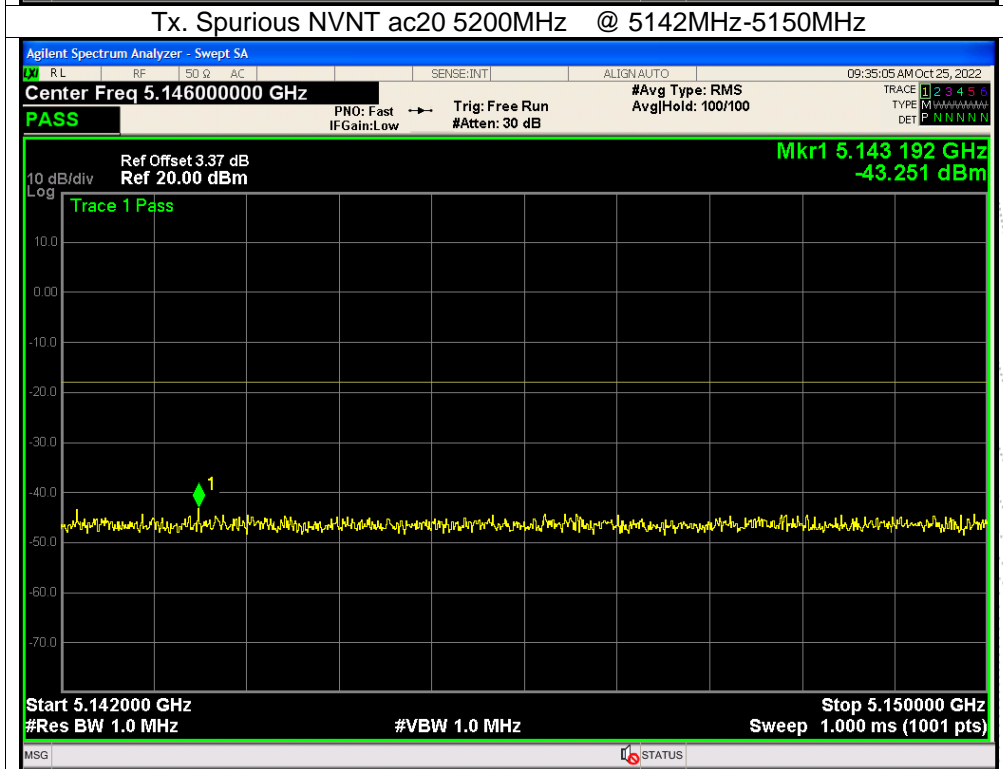
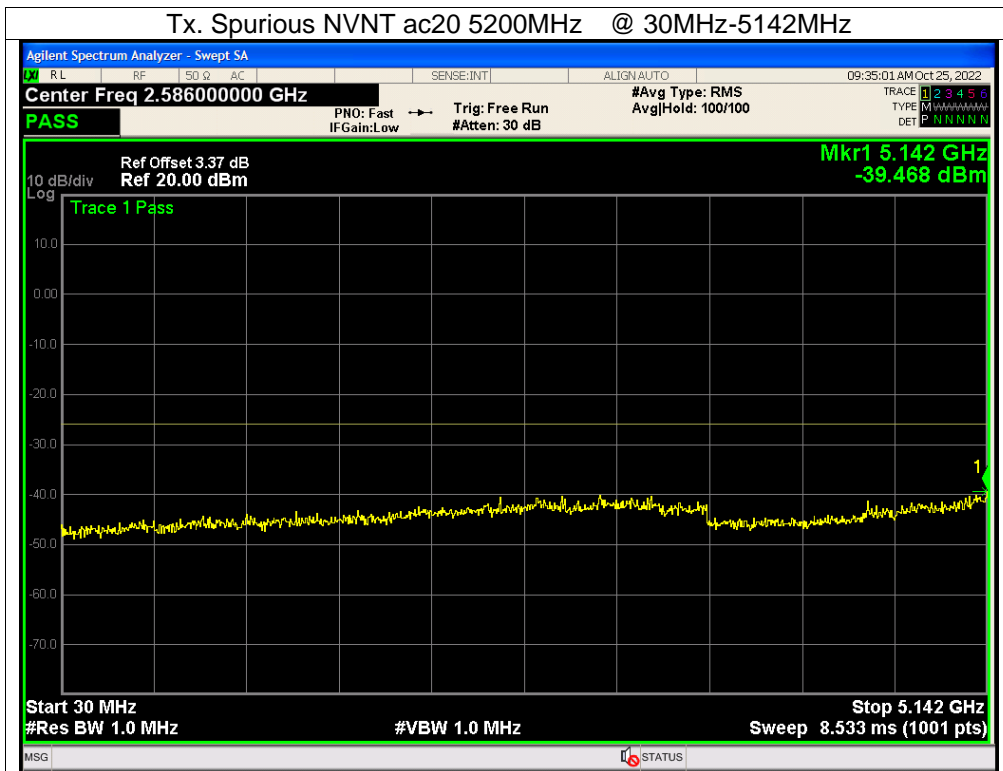

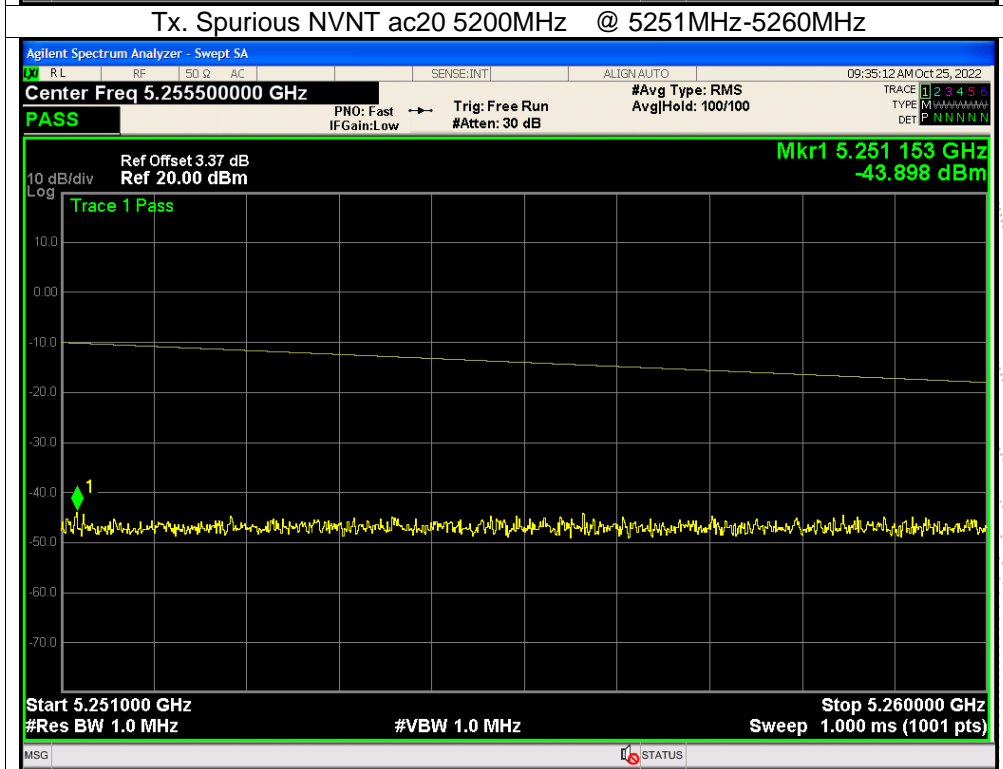
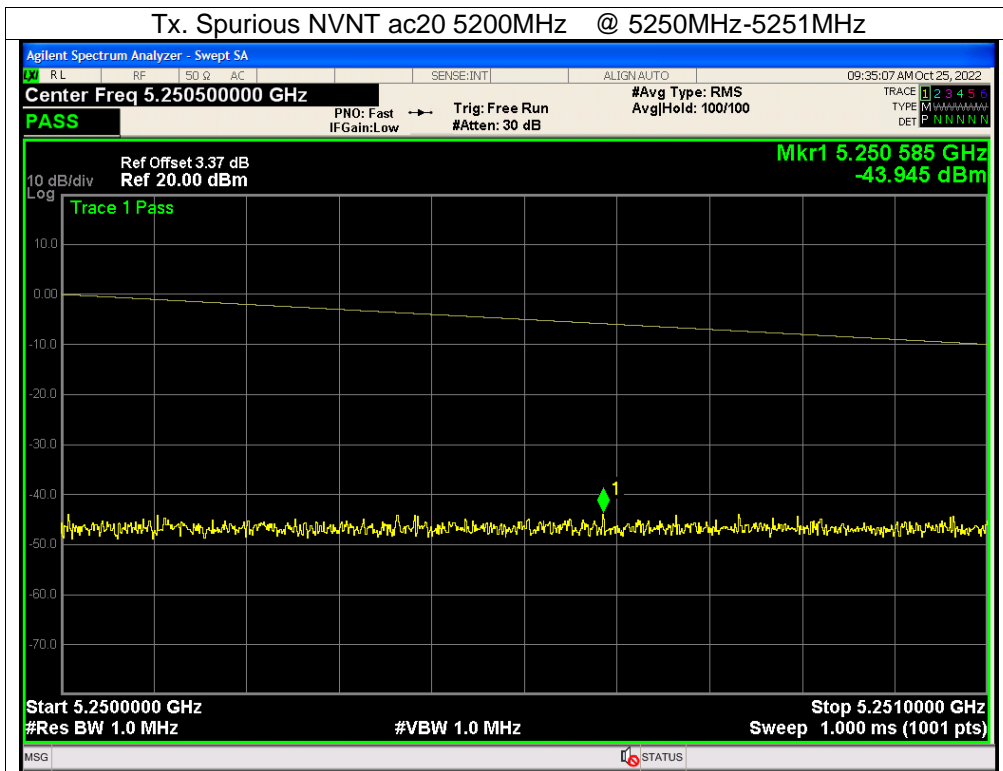

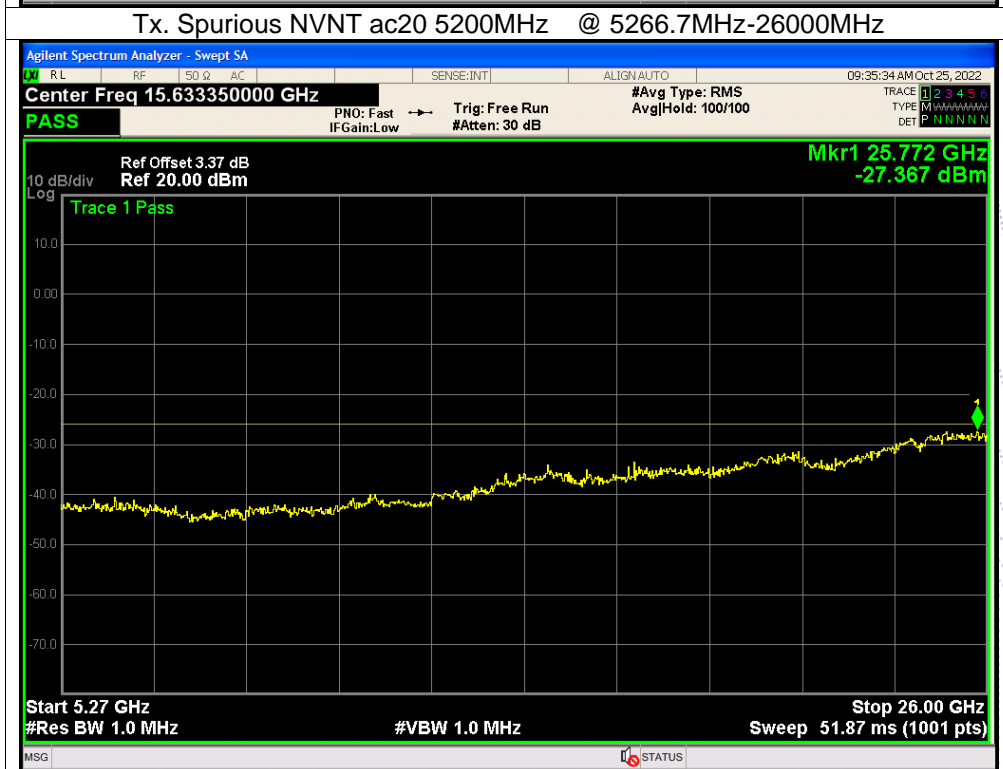
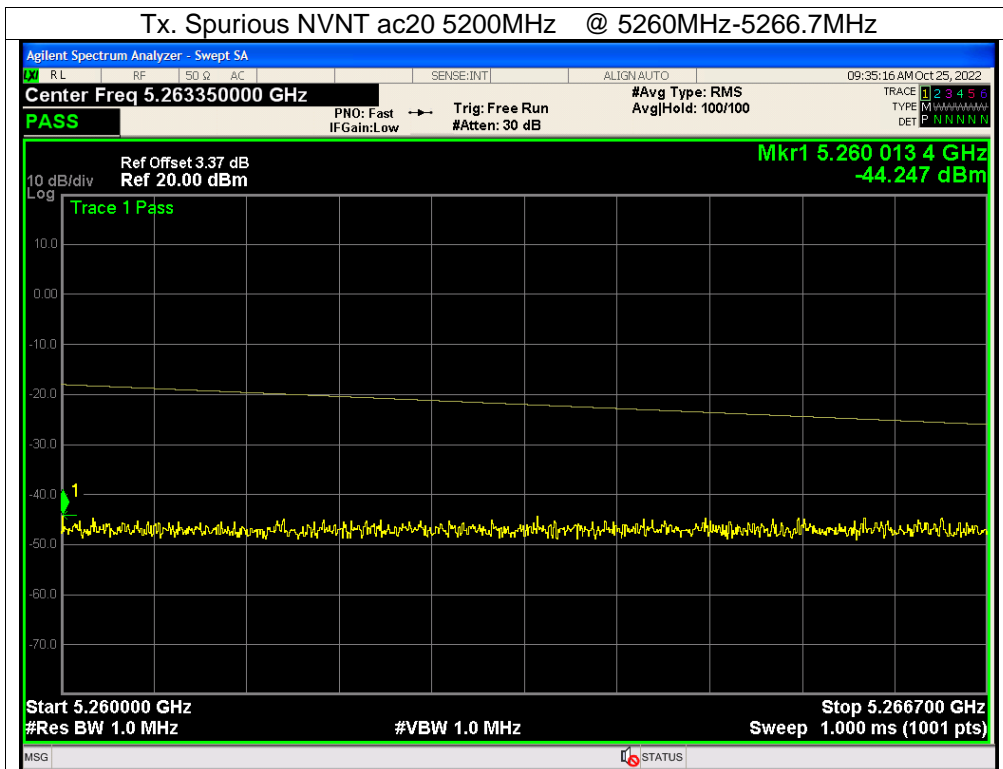

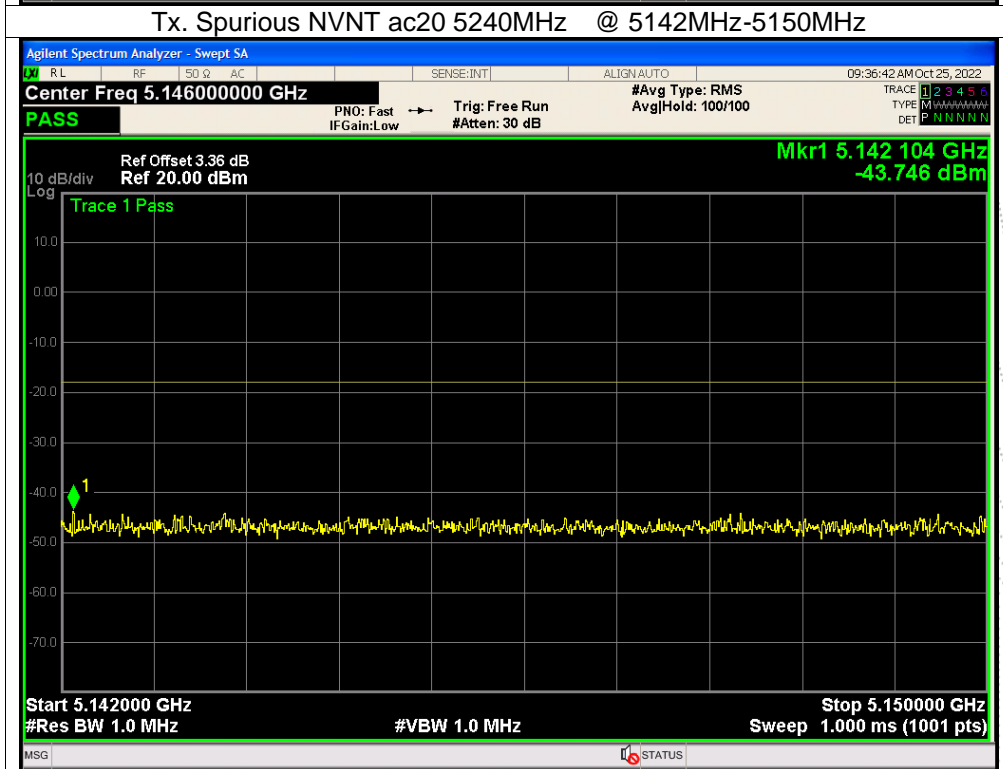
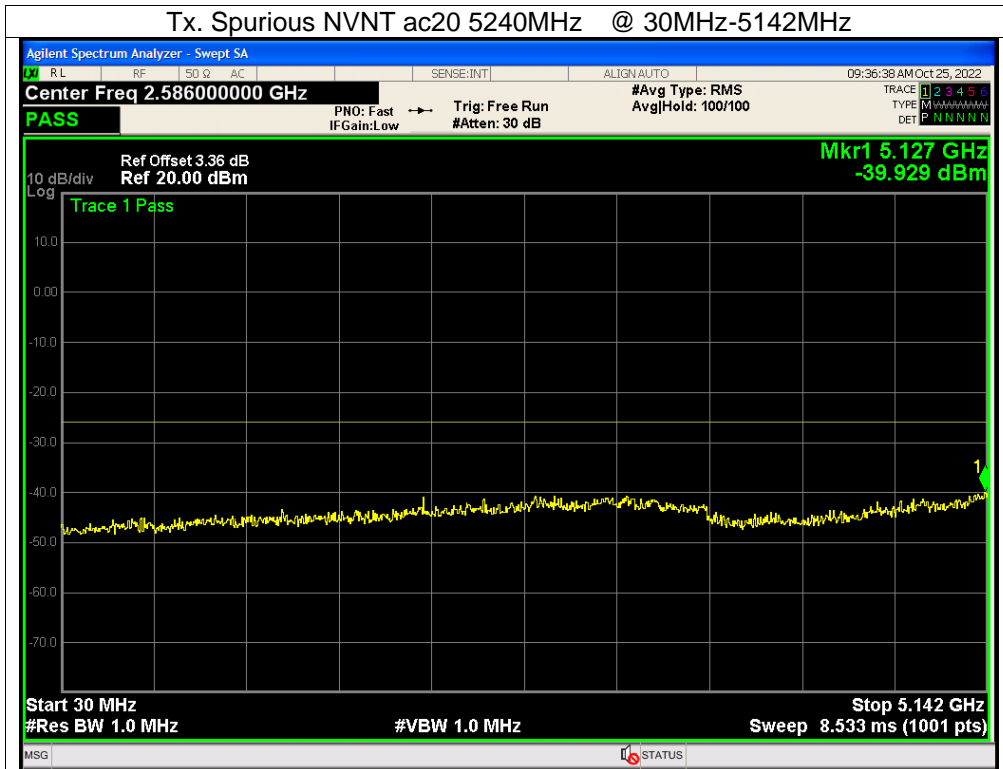

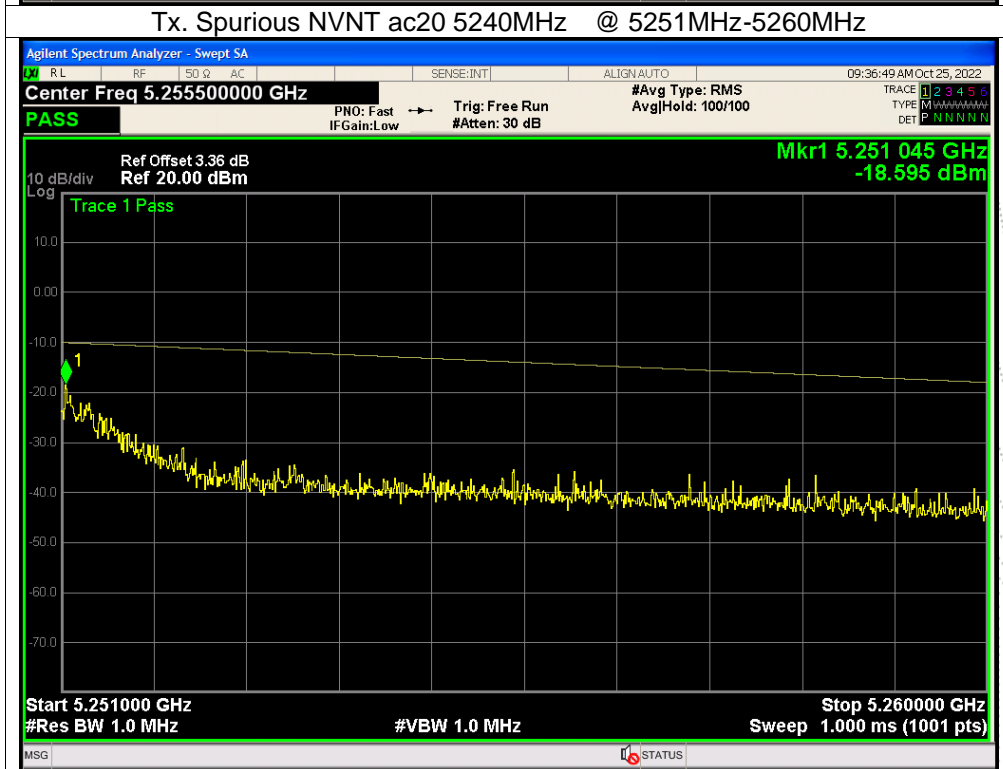
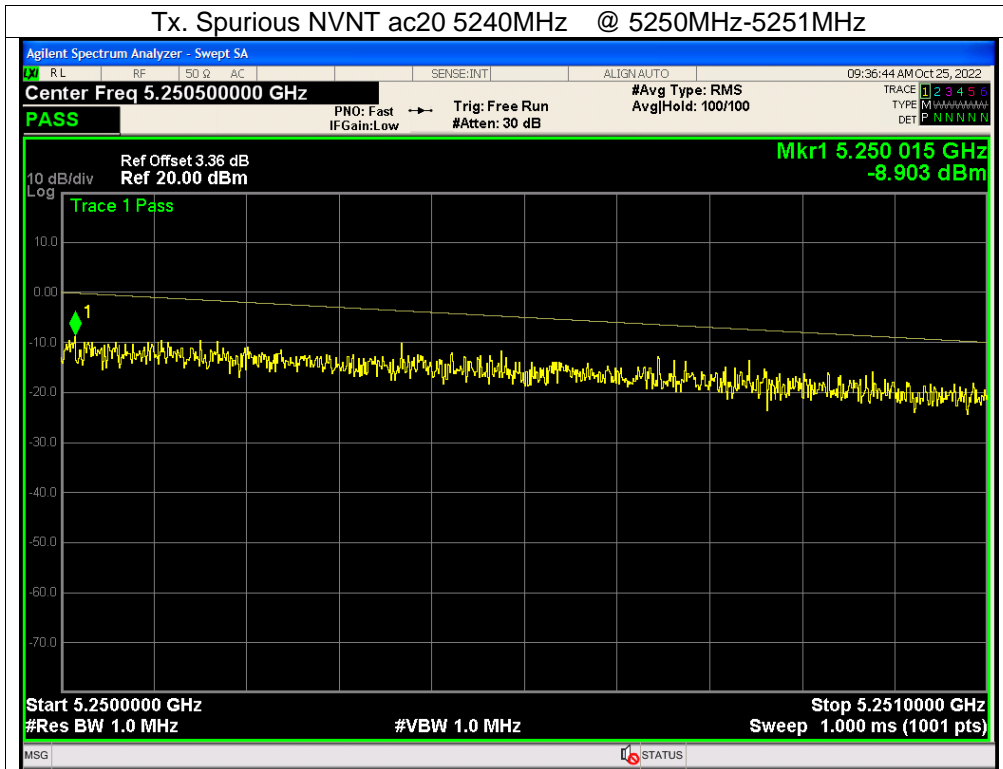

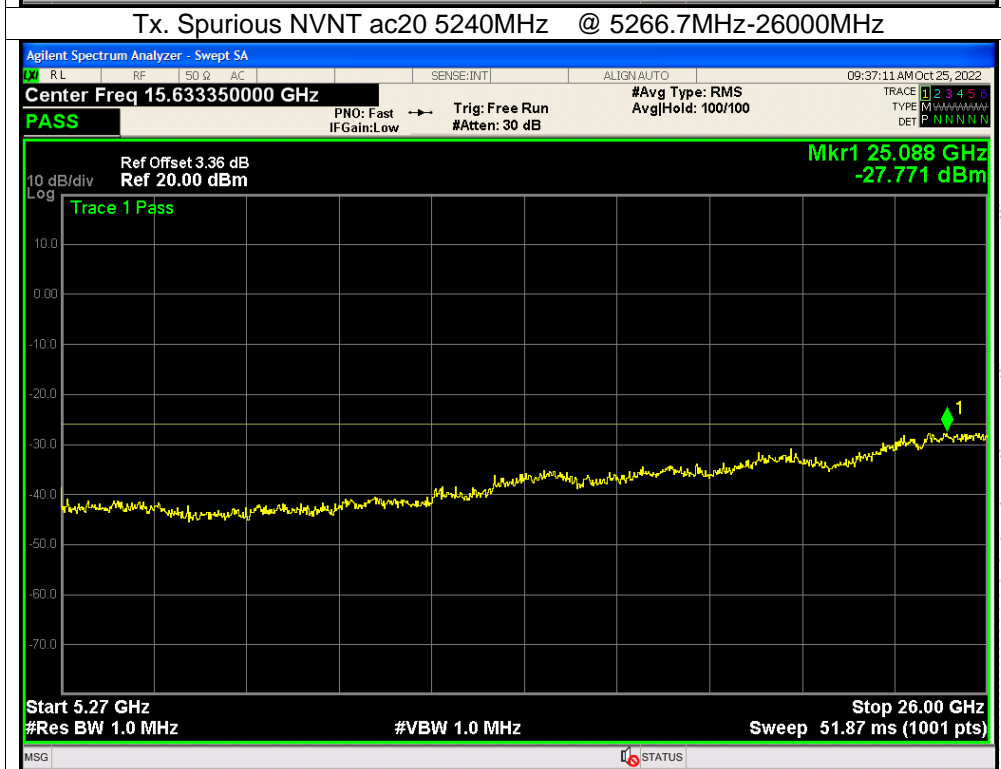
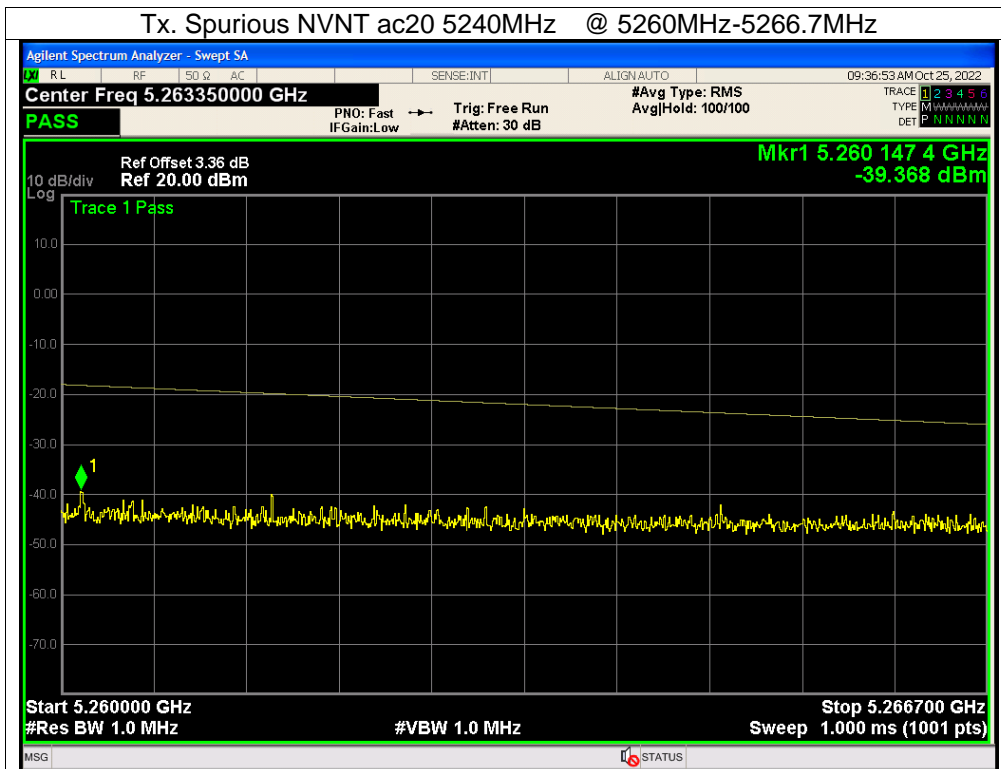

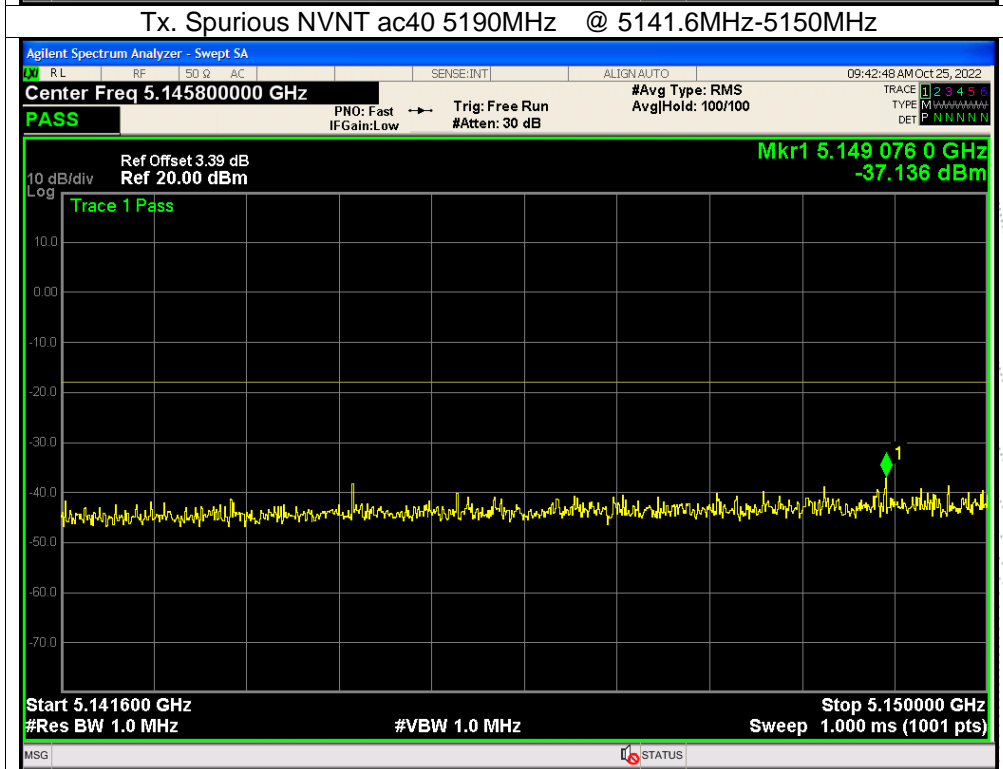
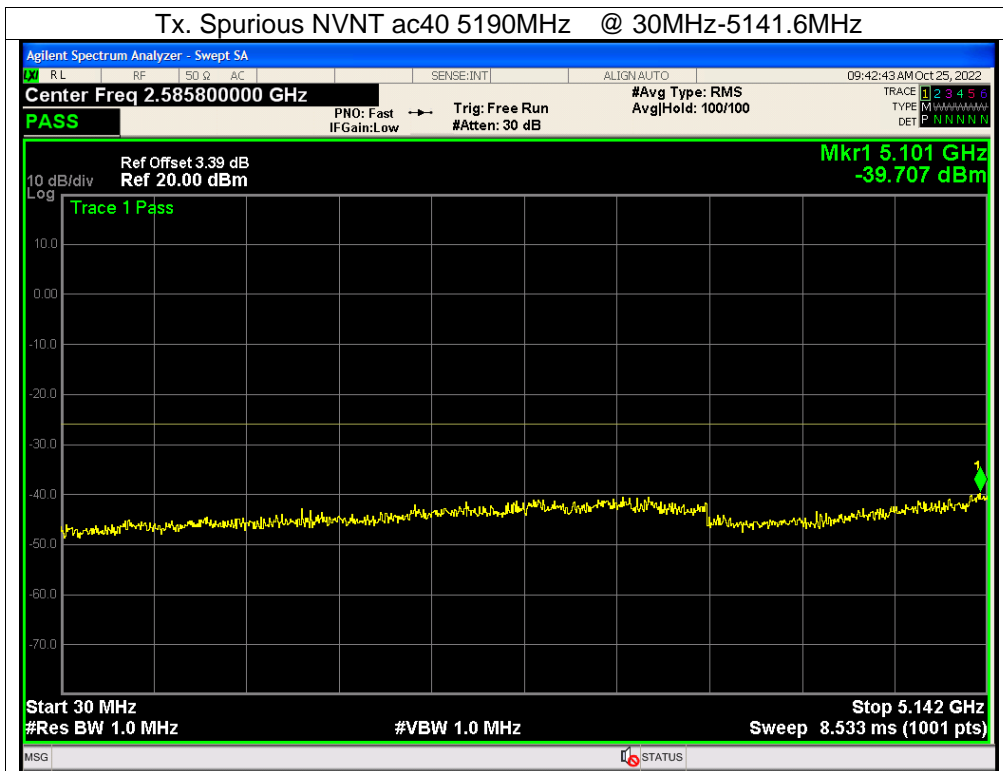

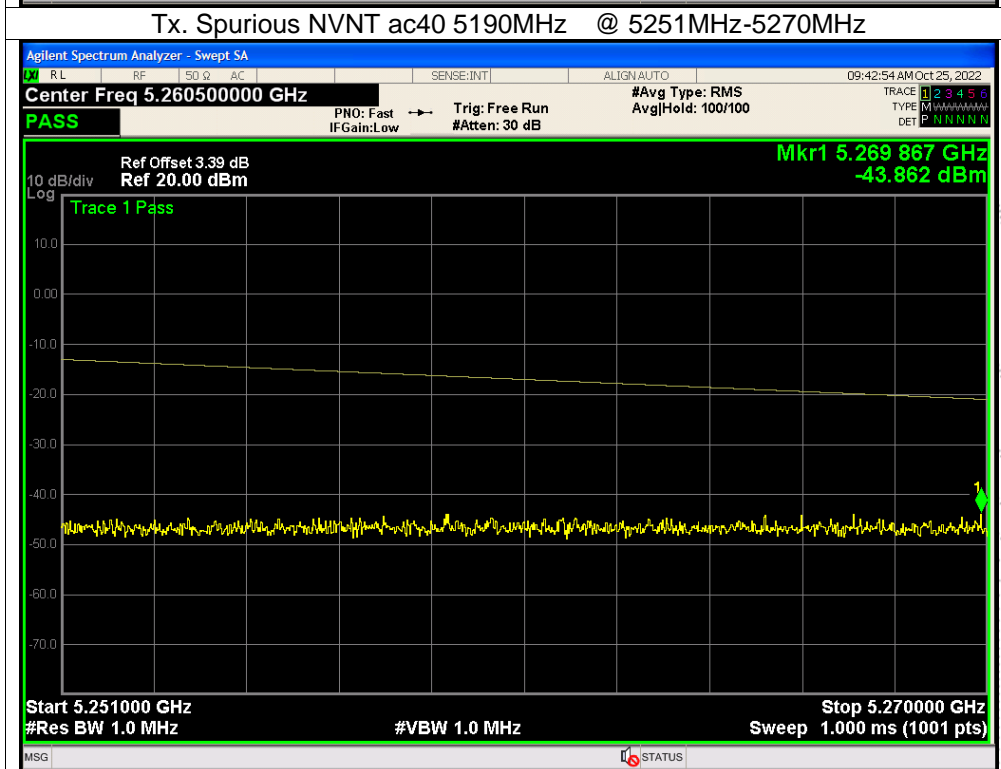
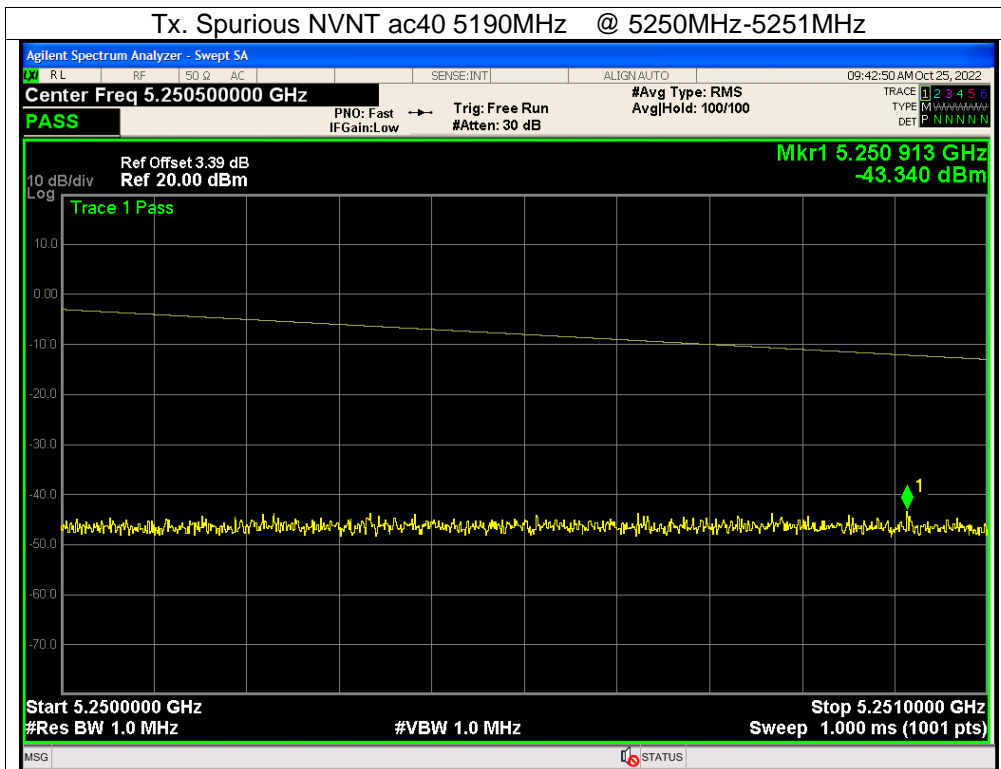

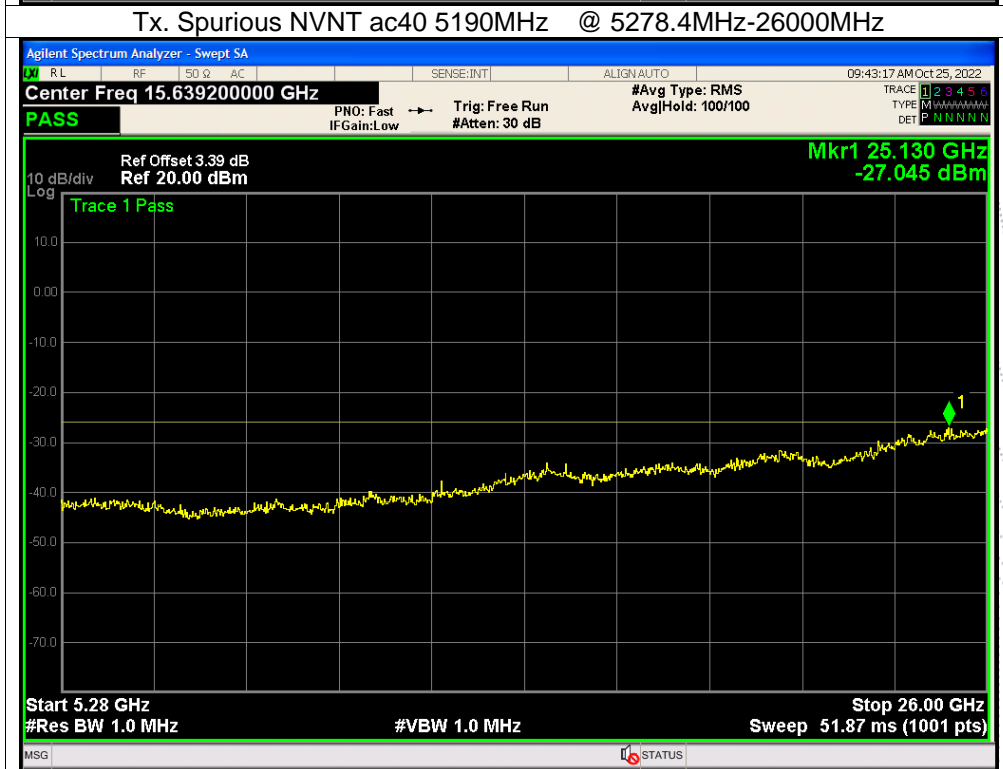
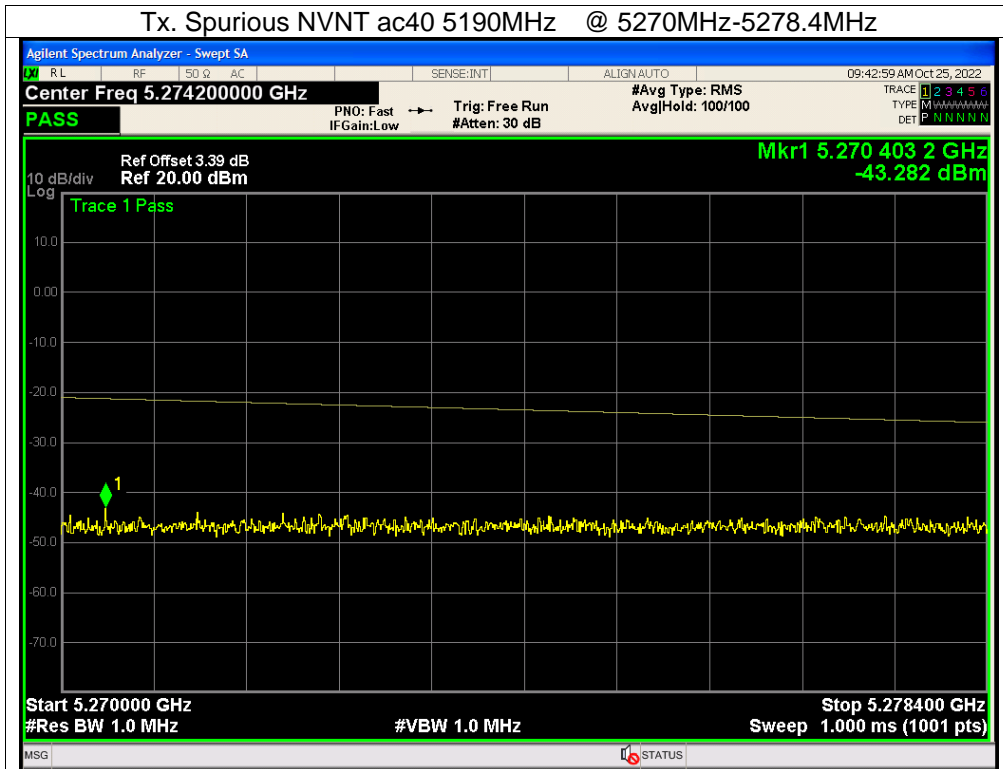

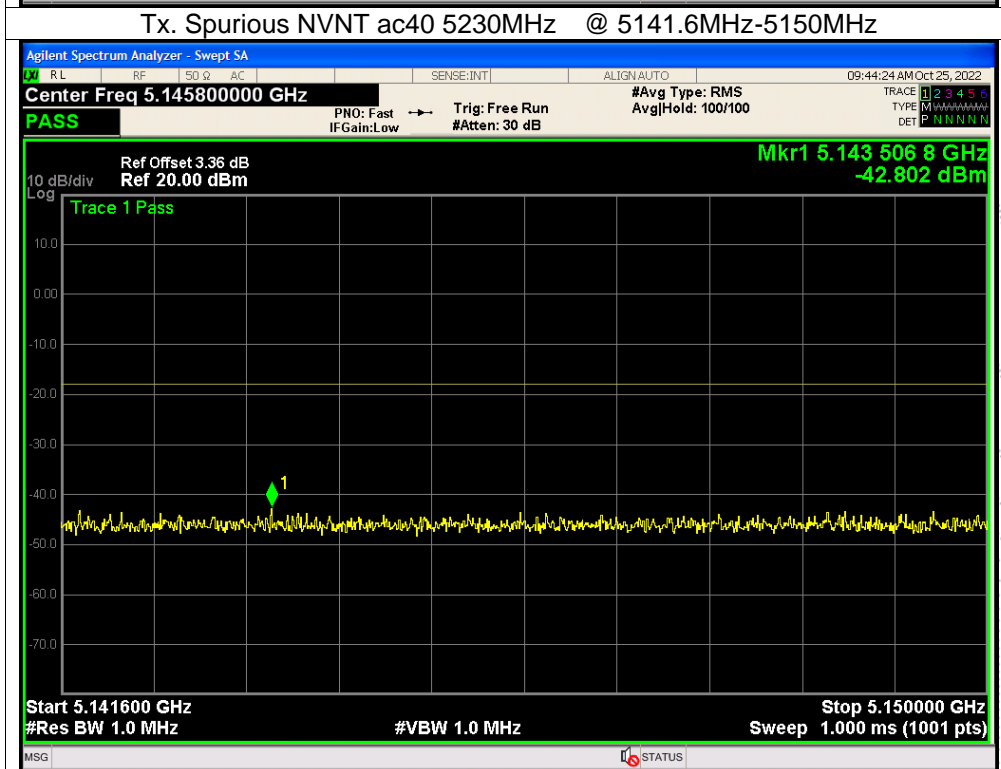
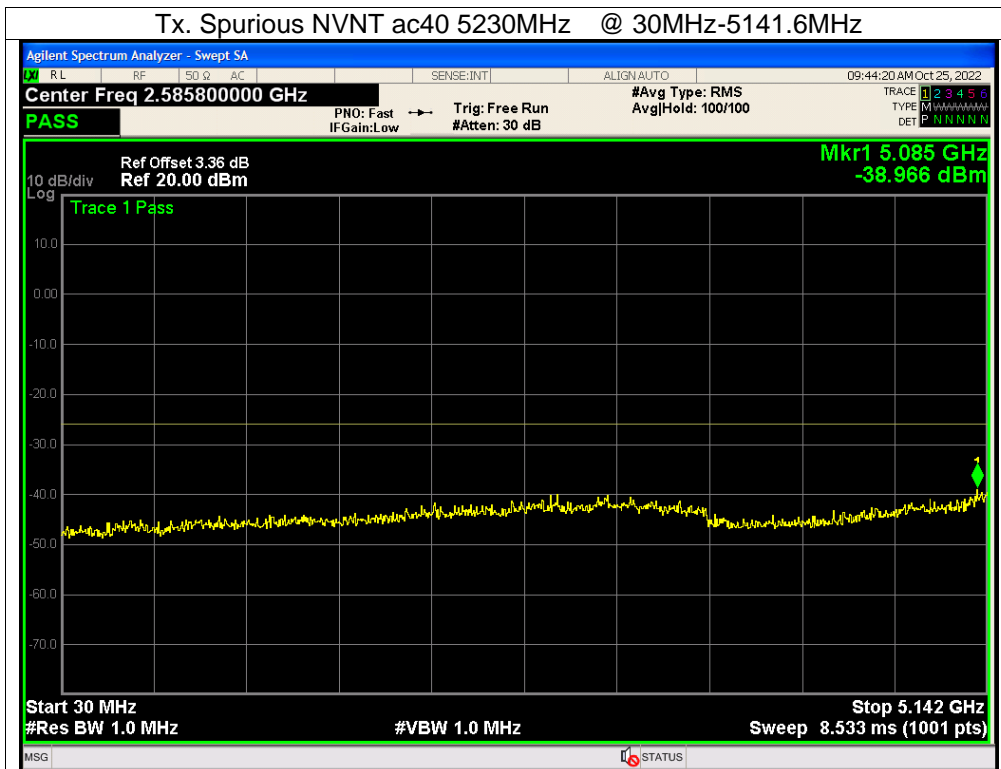

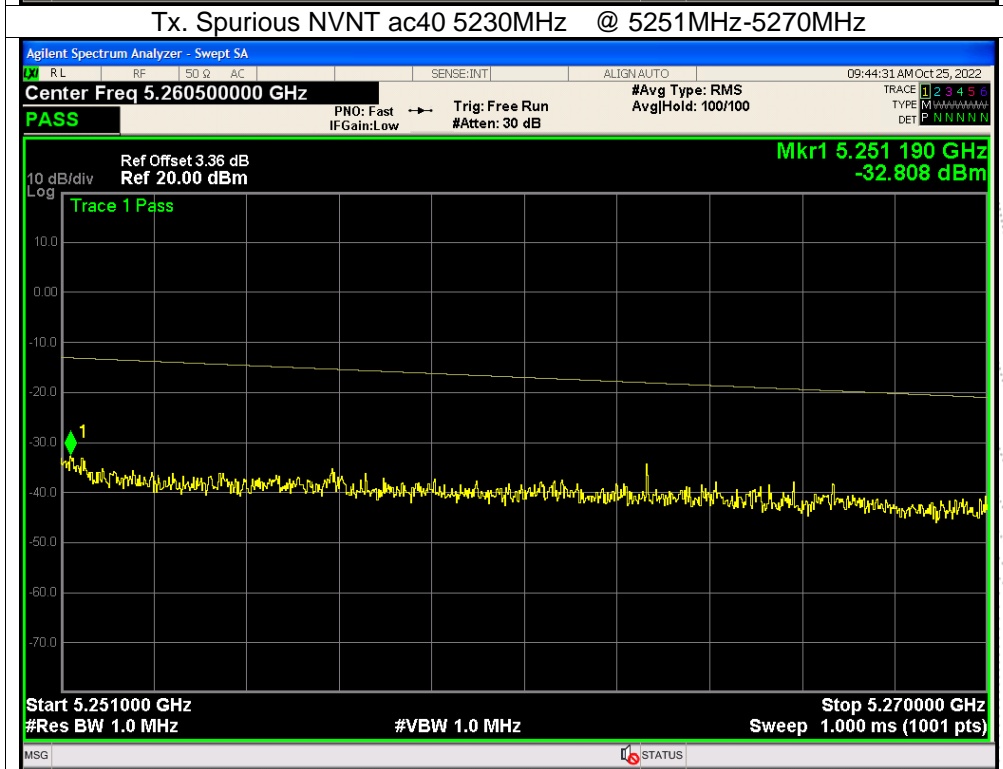
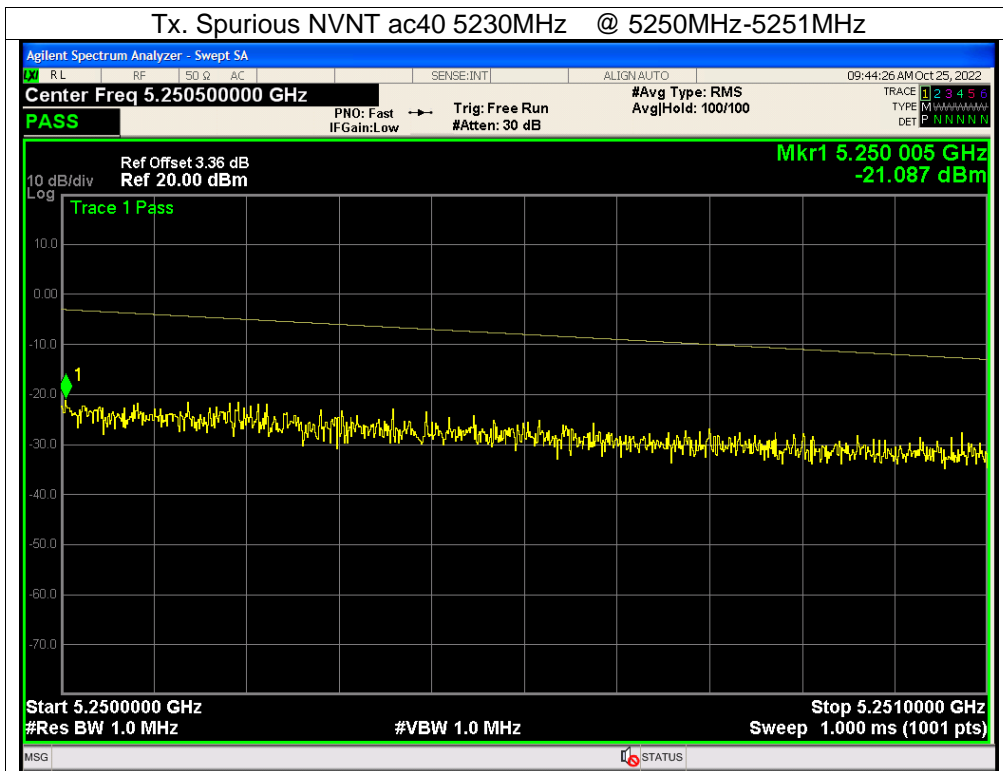

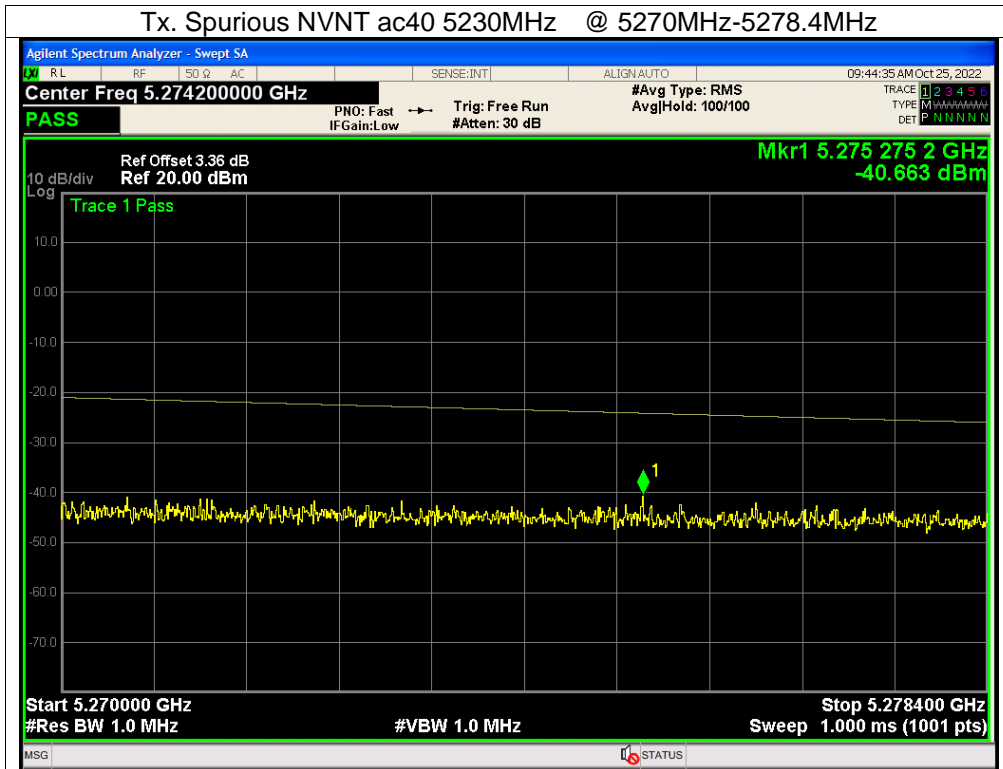

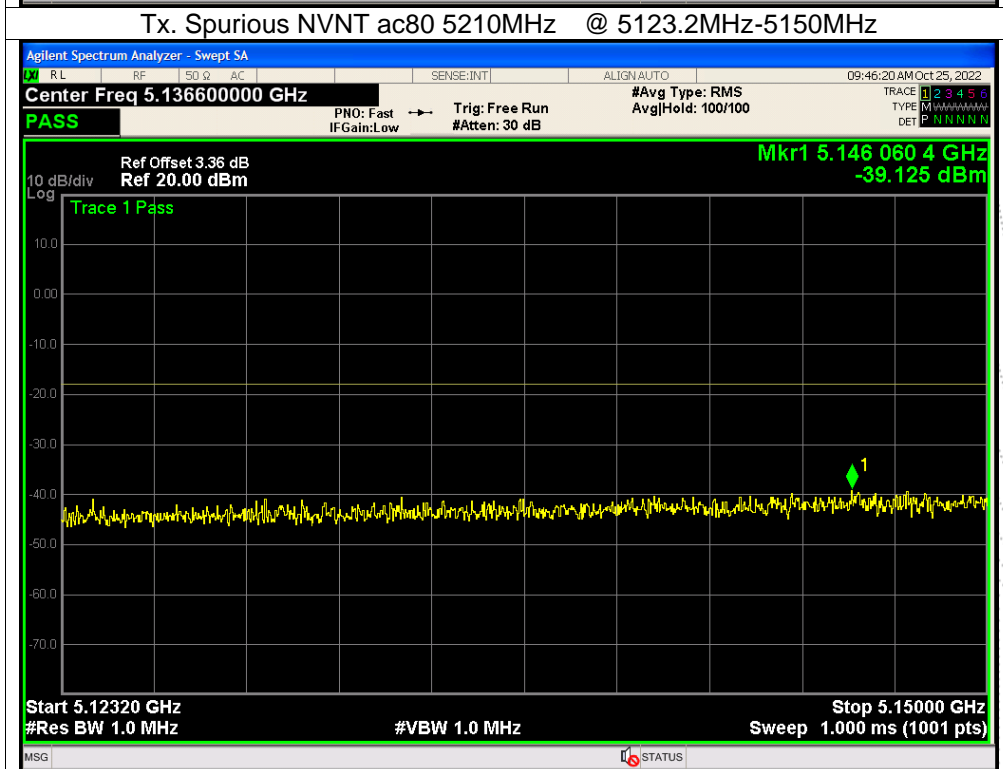
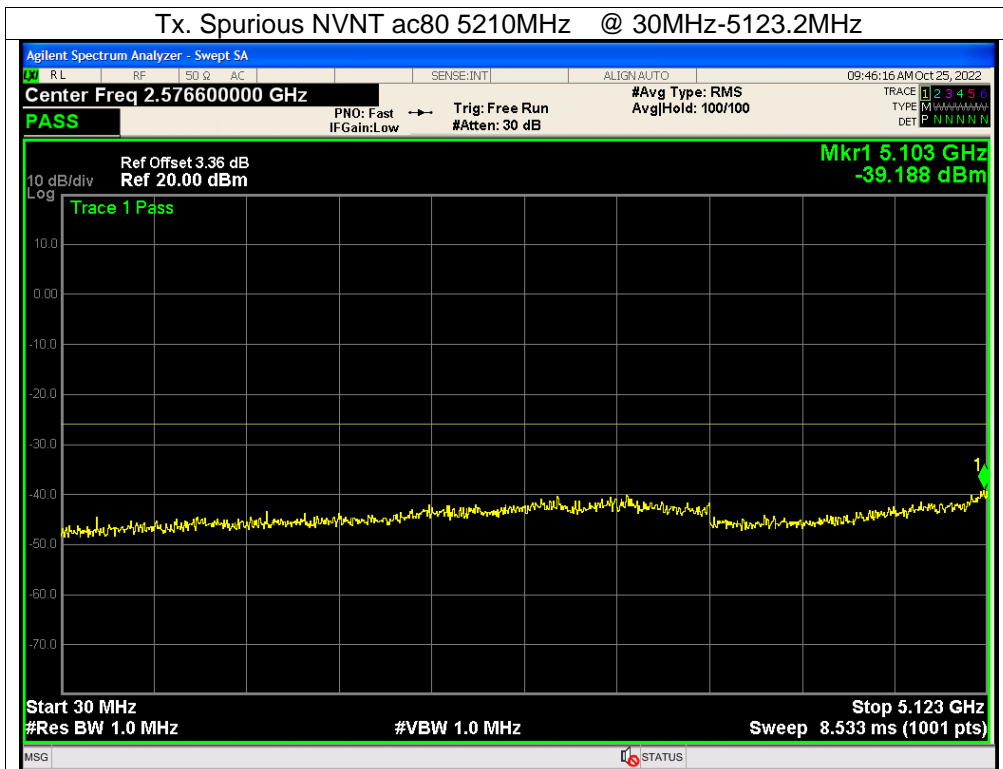

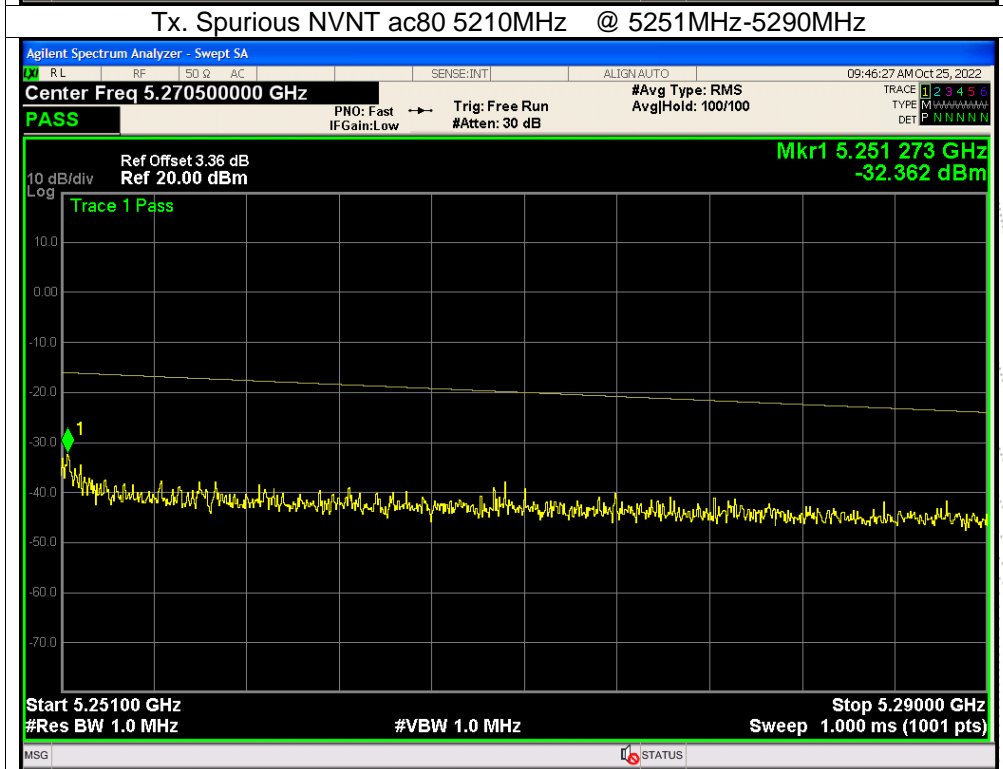
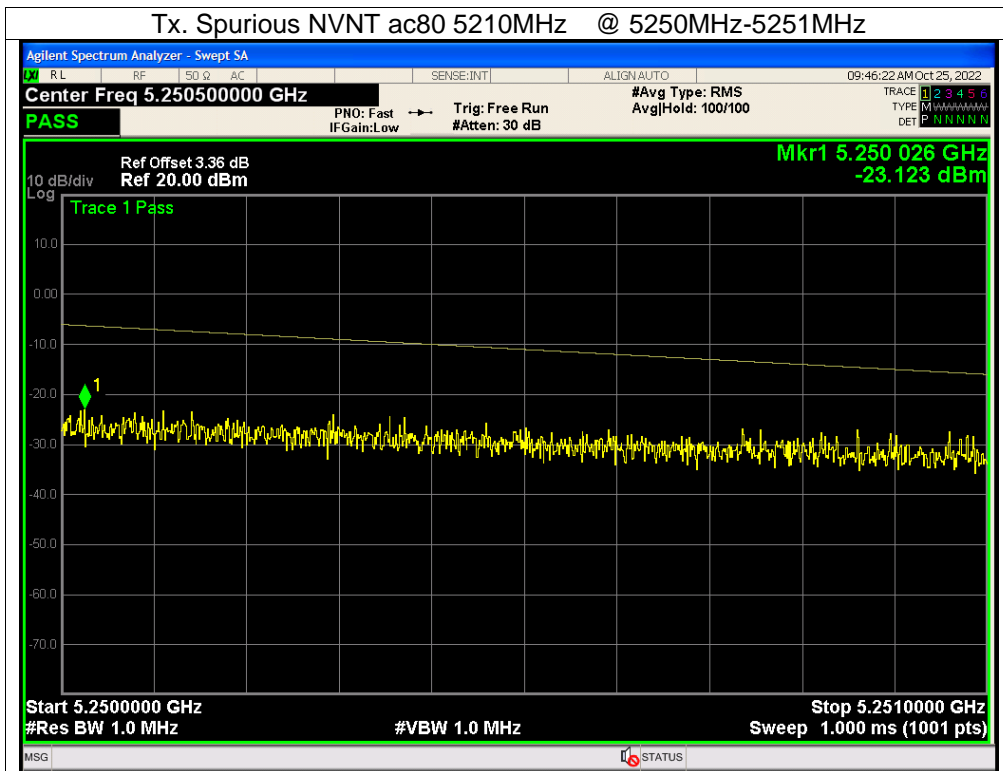

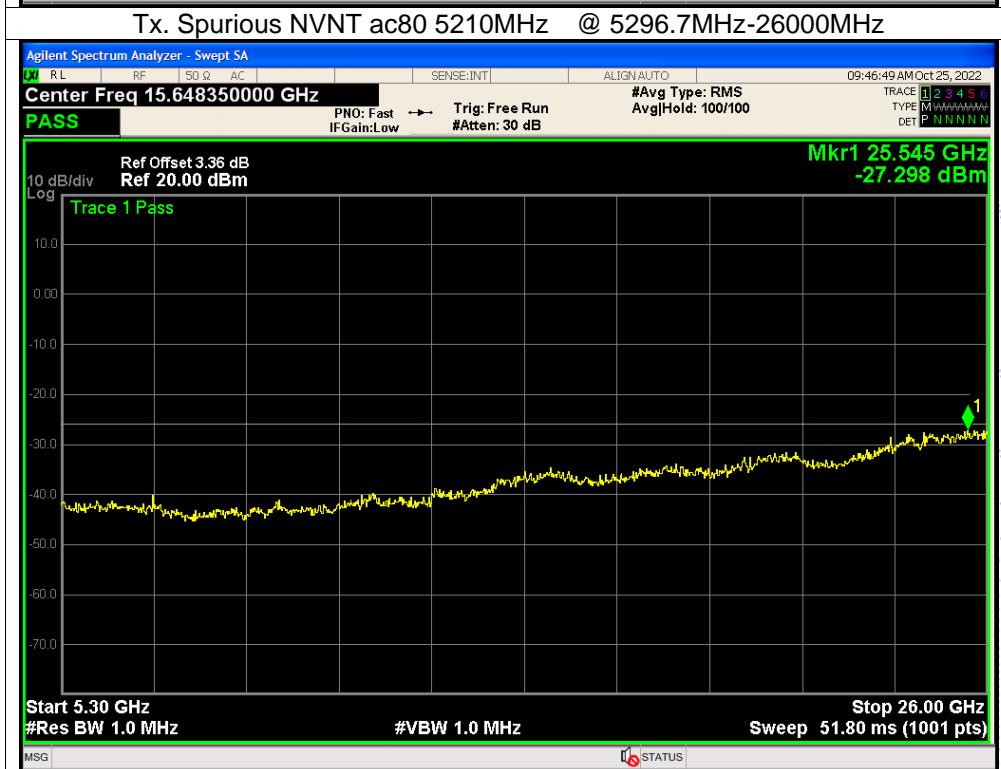
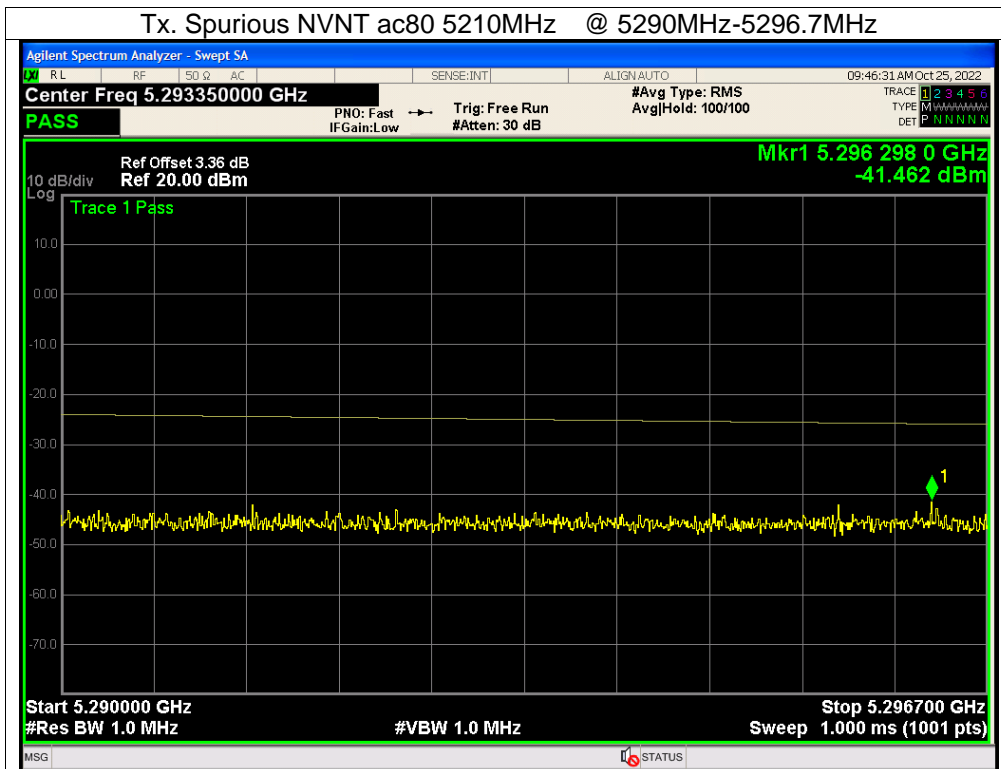

11. Secondary Radiated Emissions Measurement

11.1 Block Diagram Of Test Setup

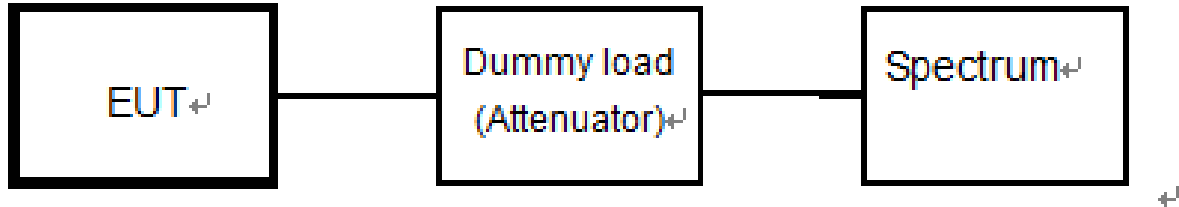

11.2 Limit

Item	Limits
RX Spurious Emission:	$\leq 4\text{nW}$ ($f < 1\text{GHz}$)
	$\leq 20\text{nW}$ ($1\text{GHz} \leq f$)

11.3 Measuring Instruments And Setting

Please refer to section 5 in this report. The following table is the setting of Spectrum Analyzer.

Spectrum Parameter	Setting
Attenuation	Auto
RB	100 kHz (below 1GHz emissions) 1 MHz (above 1GHz emissions)
VB	100 kHz (below 1GHz emissions) 1 MHz (above 1GHz emissions)
Detector	Peak
Trace	Max Hold
Sweep Time	Auto

11.4 Test Procedure

- EUT have the continuous reception mode and fixed only one channelize.
- Setting of SA is following as RB / VB: 100 kHz (below 1GHz emissions) / 1 MHz (above 1GHz emissions) / AT: 6dB / Ref: -20dBm / Sweep time: Auto / Sweep Mode: Continuous sweep / Detect mode: Positive peak / Trace mode: Max hold
- SA set RB: 100kHz and VB: 100kHz. Then adjust to start frequency 30MHz and stop frequency 1000MHz. Search to mark peak reading value + cable loss shall be less than 4nW
- SA set RB: 1MHz and VB: 1MHz. Then adjust to start frequency 1000MHz and stop frequency 12500MHz. Search to mark peak reading value + cable loss shall be less than 20nW
- If power level of lower emissions are more than 1/10 of limit (.0.4nW for $f < 1\text{GHz}$, 2nW for $f \geq 1\text{GHz}$), all those are to be indicated in the 2nd and 3rd lines. If others are 1/10 or less more of the limit, no necessary to be indicated.

11.5 Test Result

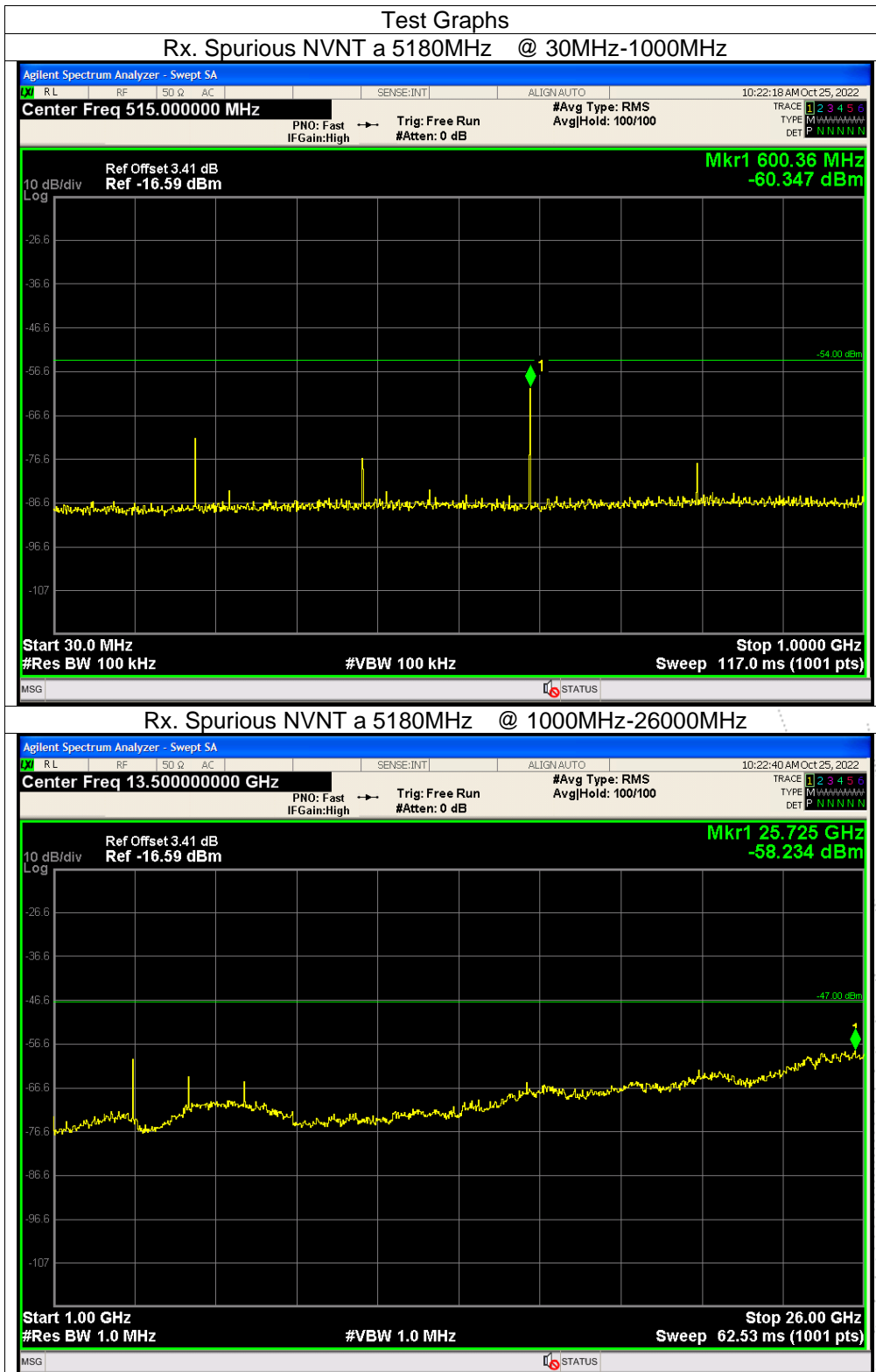

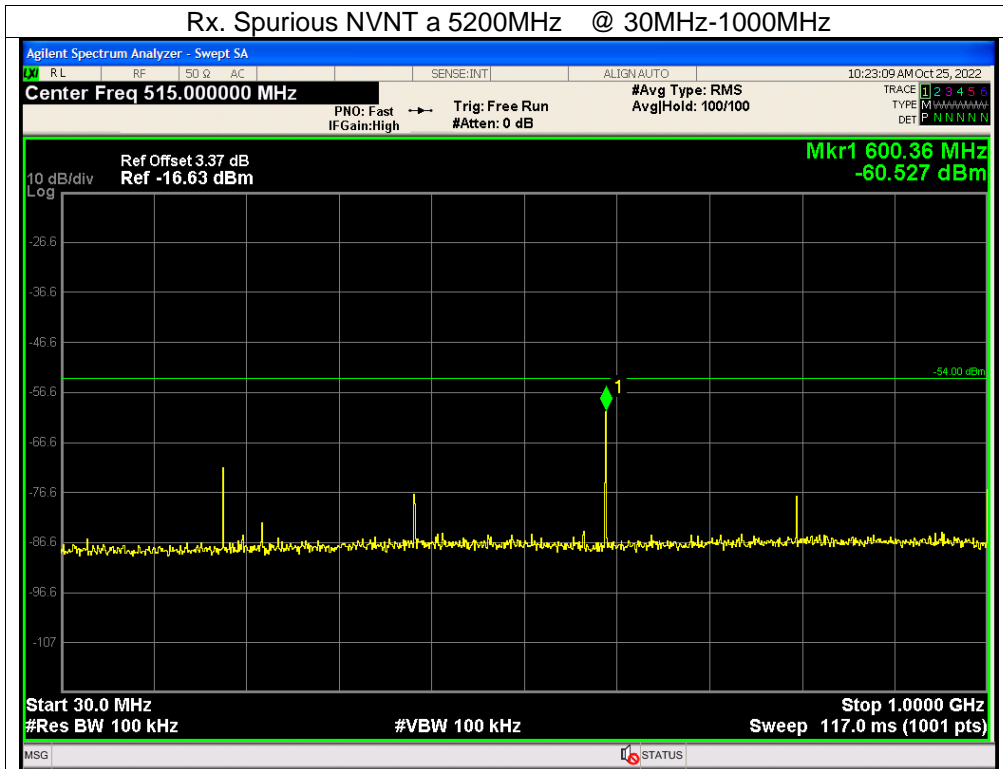

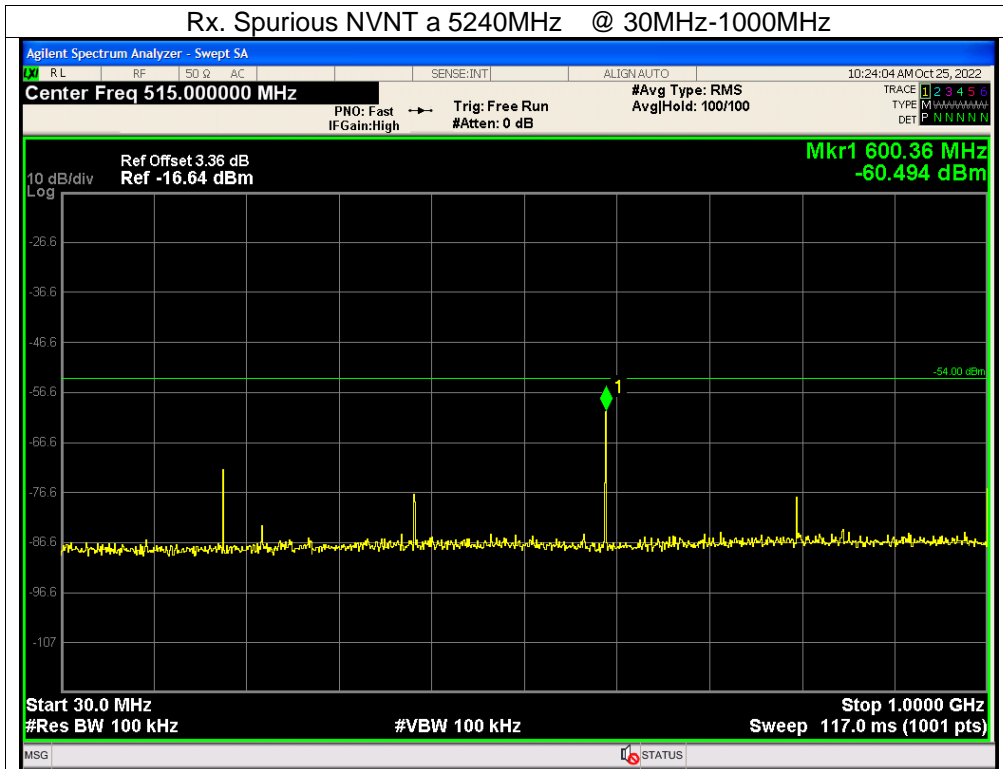

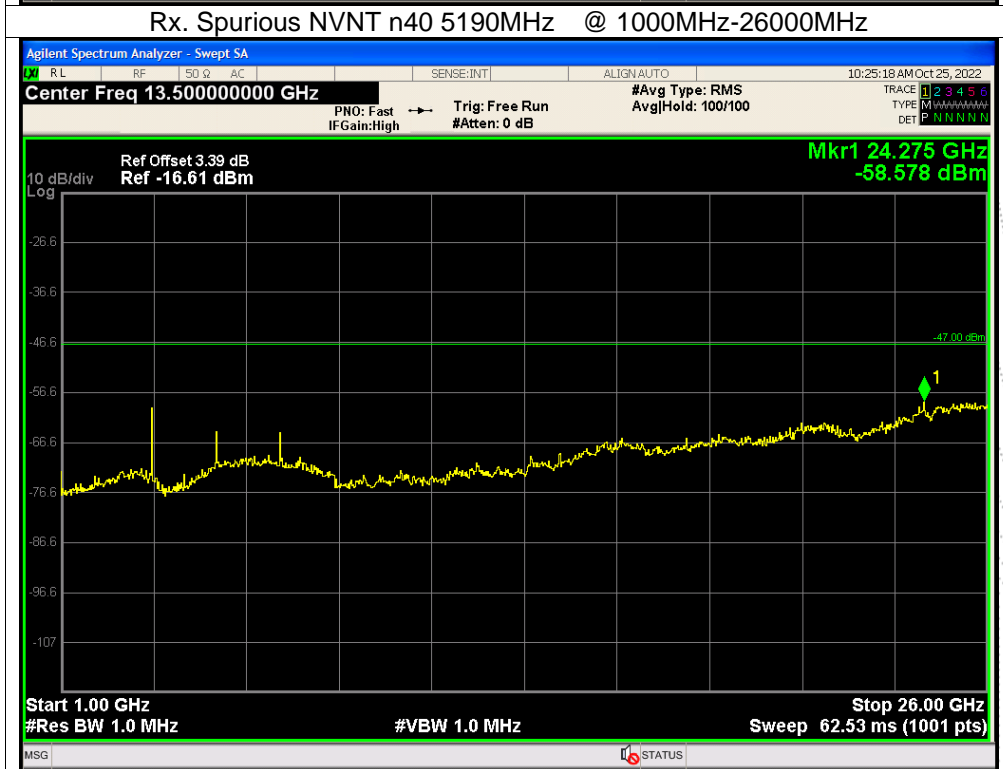
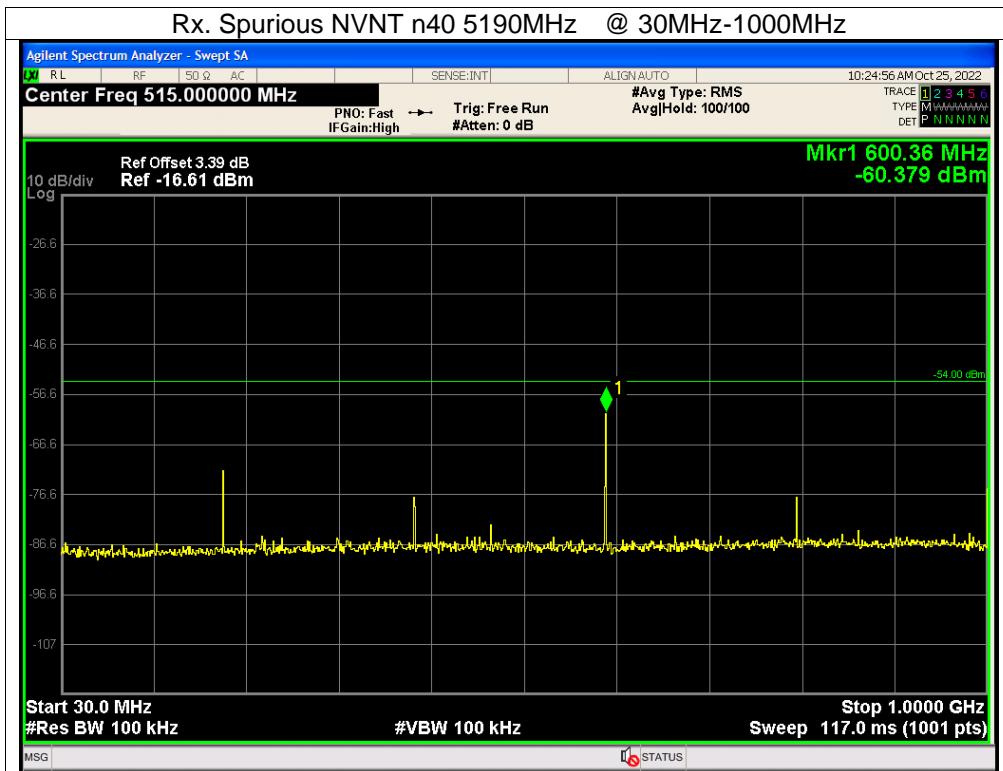

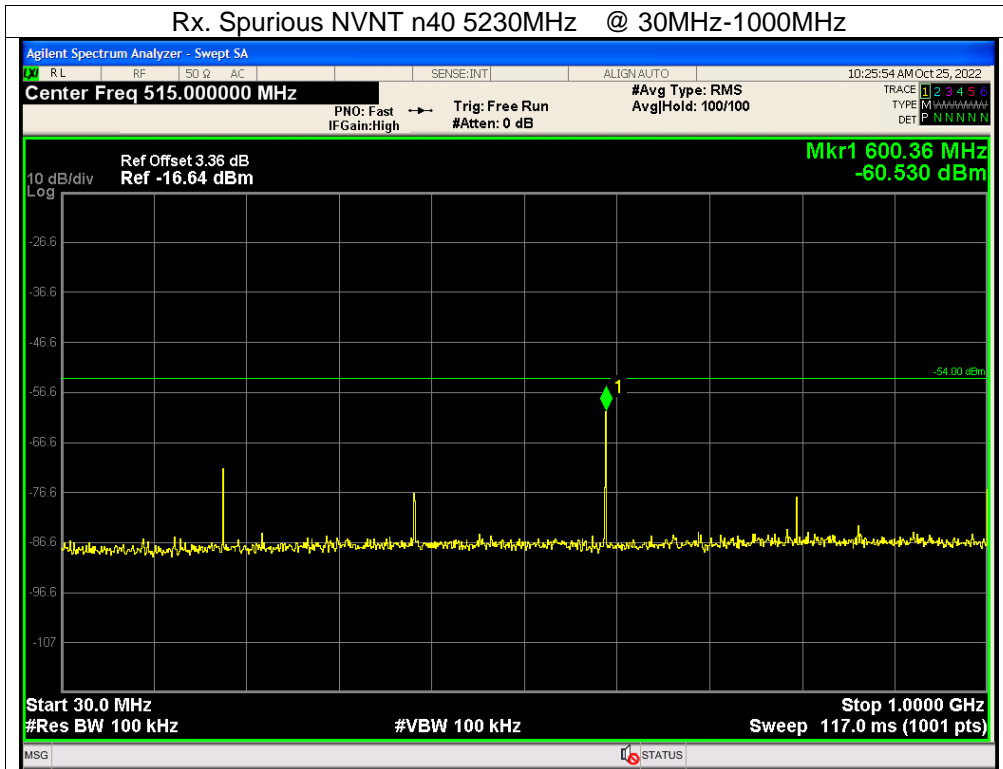

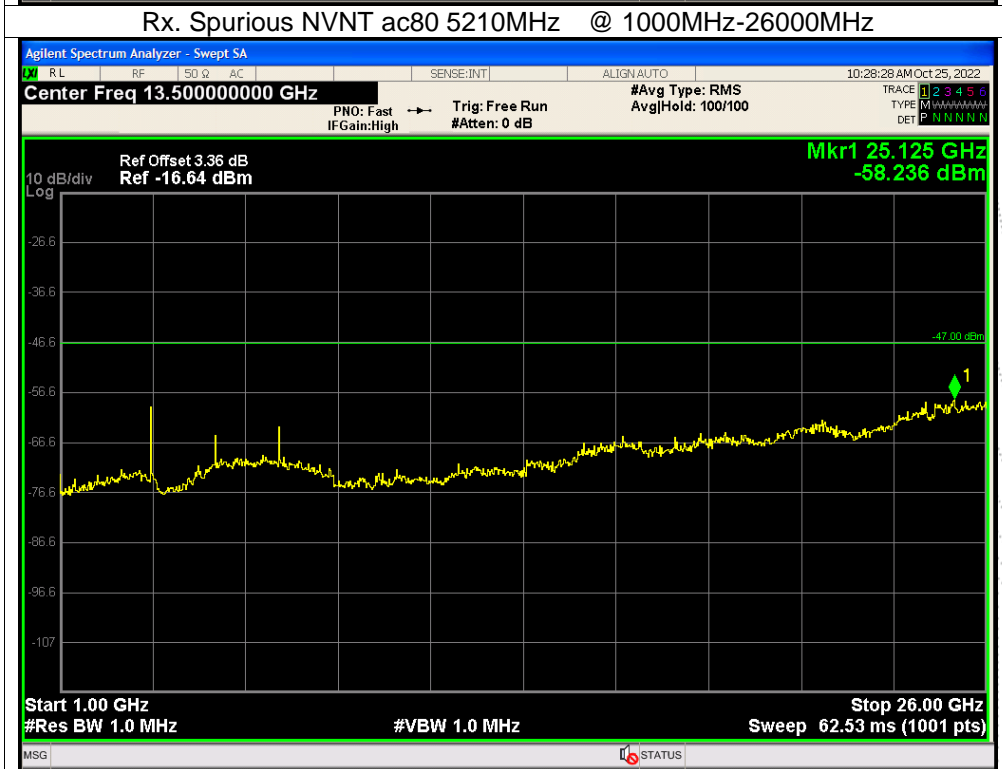
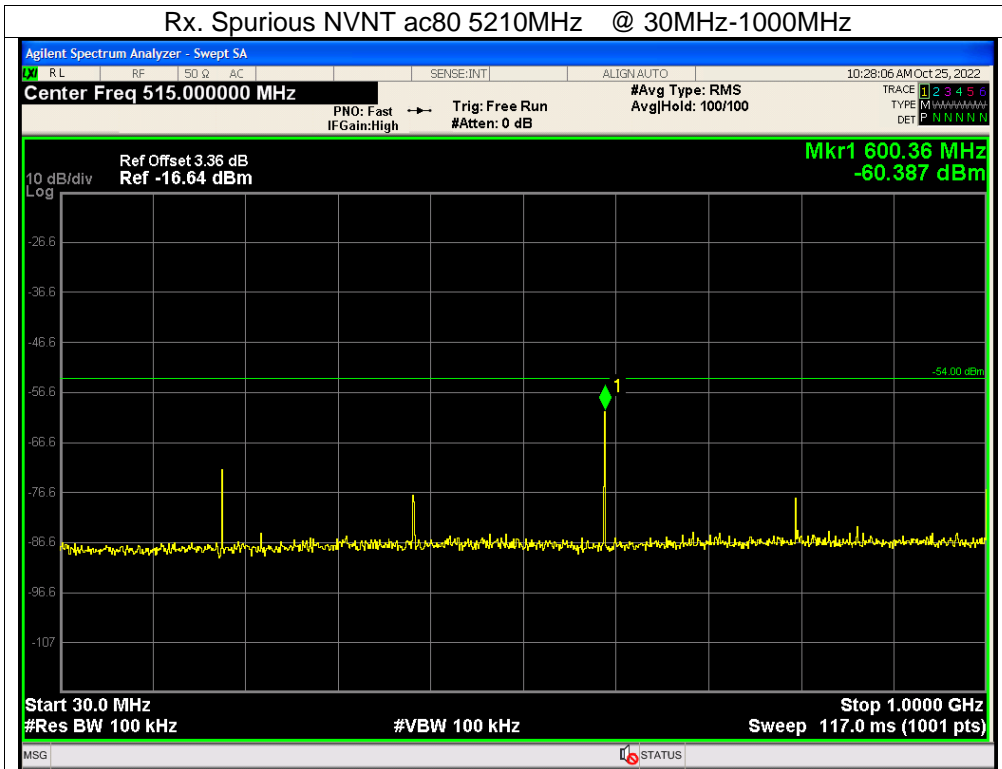

12. Transmitter Burst Length Measurement

12.1 Block Diagram Of Test Setup

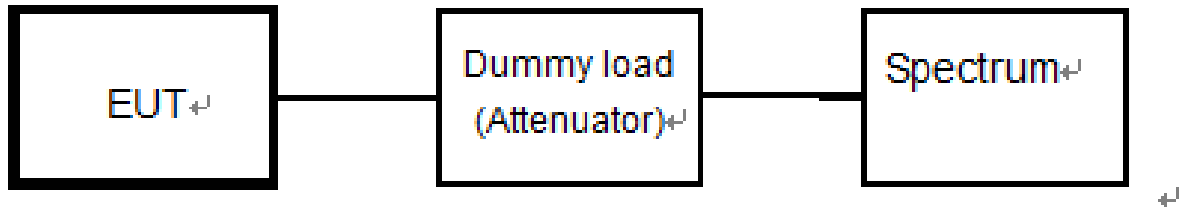

12.2 Limit

Item	Limits
Transmitter Burst Length	≤8msecond

12.3 Measuring Instruments And Setting

Please refer to section 5 in this report. The following table is the setting of Spectrum Analyzer.

Spectrum Parameter	Setting
Center frequency	Test frequency
Sweep bandwidth	0Hz
Resoluble bandwidth	1MHz
Video bandwidth	equivalent to resolvable bandwidth
Sweep Time	Minimum time to assure measuring accuracy
Y-axis scale	10dB/Div.
Detection mode	Positive peak
Trigger condition	Rising up of level

12.4 Test Result

Condition	Mode	Antenna	Burst Length (ms)	Limit (ms)	Verdict
NVNT	a	5180	1.397	8	Pass
NVNT	a	5200	1.397	8	Pass
NVNT	a	5240	1.397	8	Pass
NVNT	N20	5180	1.893	8	Pass
NVNT	N20	5200	1.892	8	Pass
NVNT	N20	5240	1.893	8	Pass
NVNT	n40	5190	0.65	8	Pass
NVNT	n40	5230	0.65	8	Pass
NVNT	ac20	5180	1.901	8	Pass
NVNT	ac20	5200	1.9	8	Pass
NVNT	ac20	5240	1.9	8	Pass
NVNT	ac40	5190	0.938	8	Pass
NVNT	ac40	5230	0.937	8	Pass
NVNT	ac80	5210	0.311	8	Pass

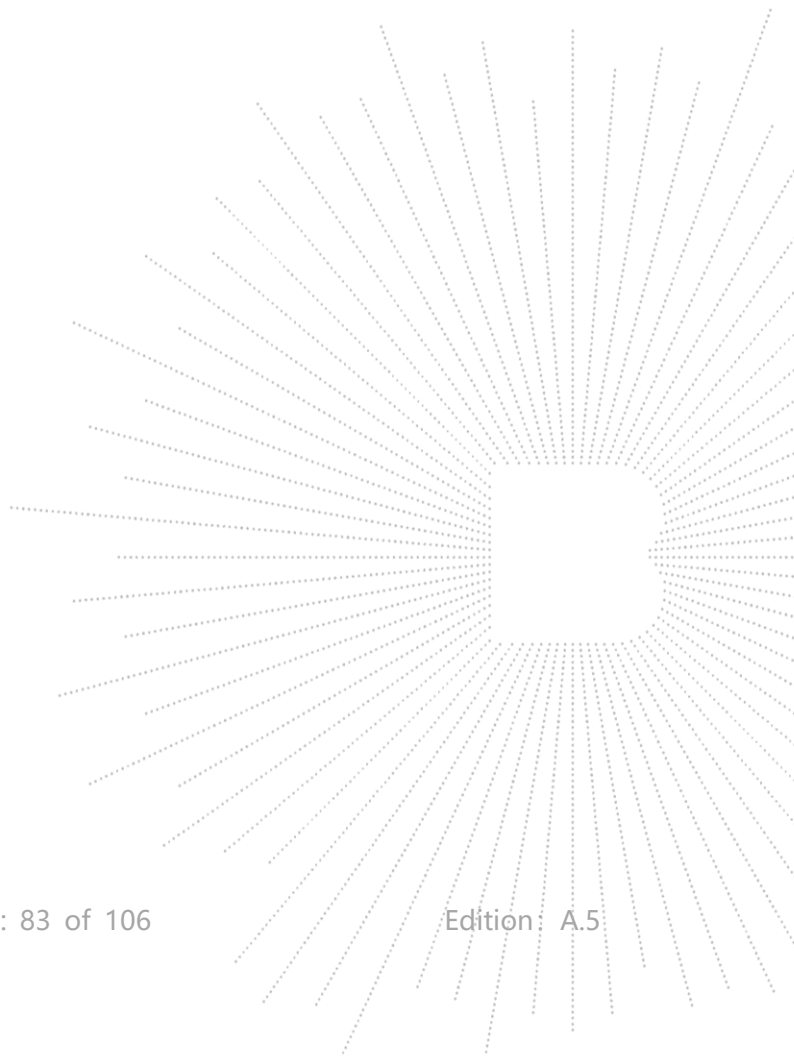

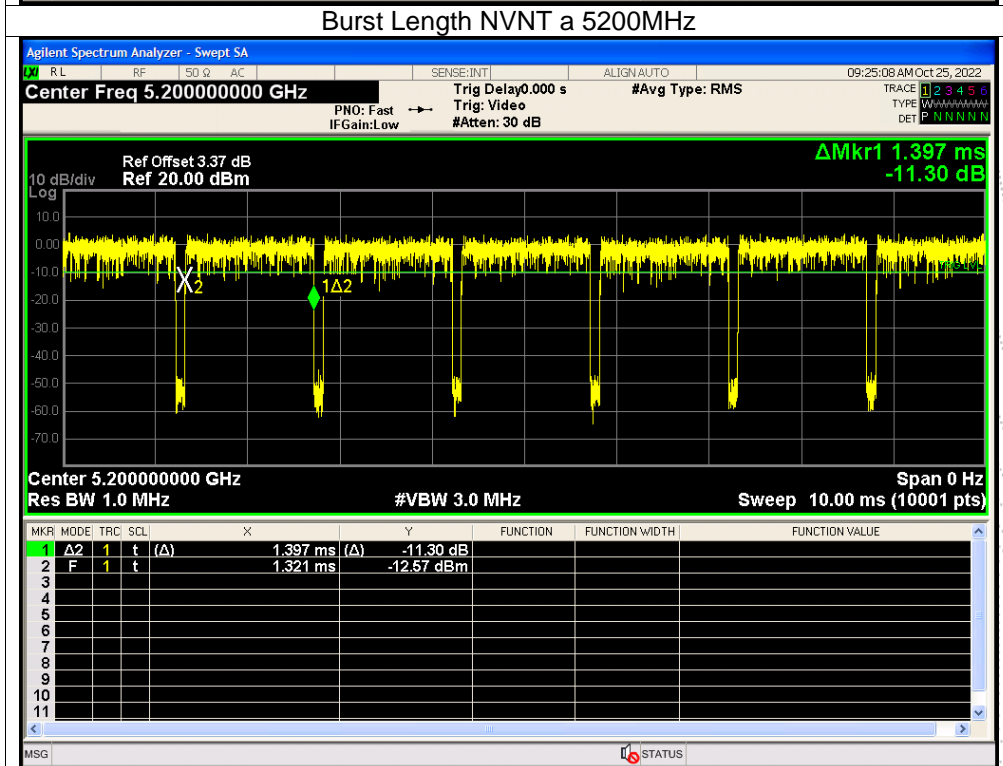
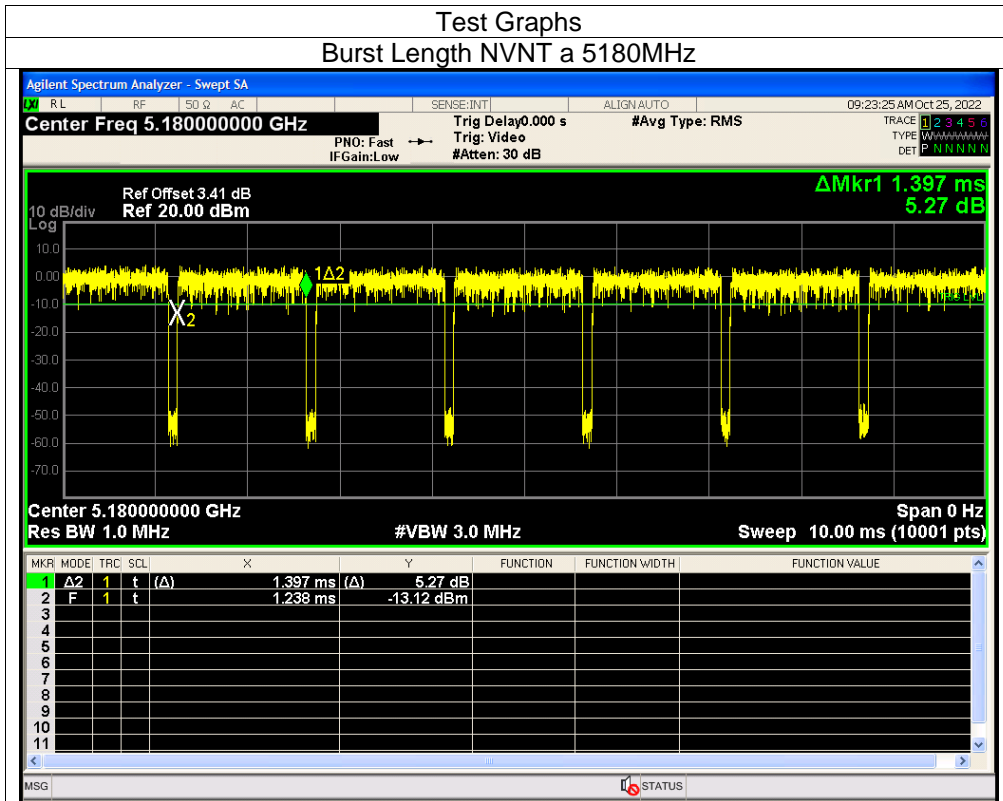

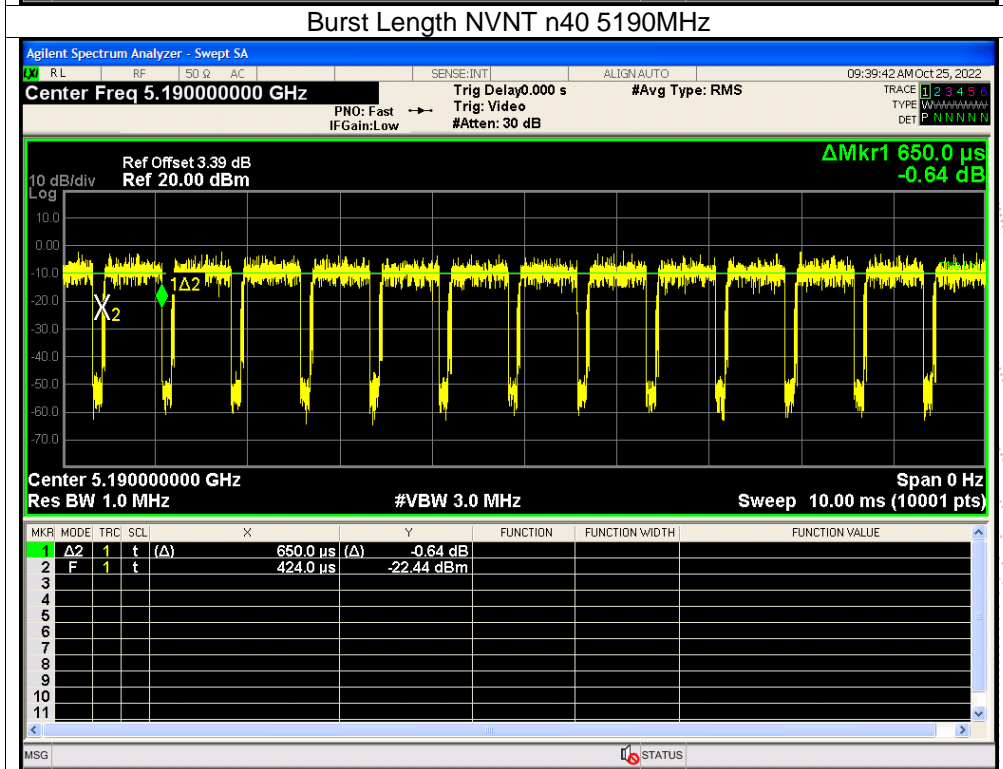
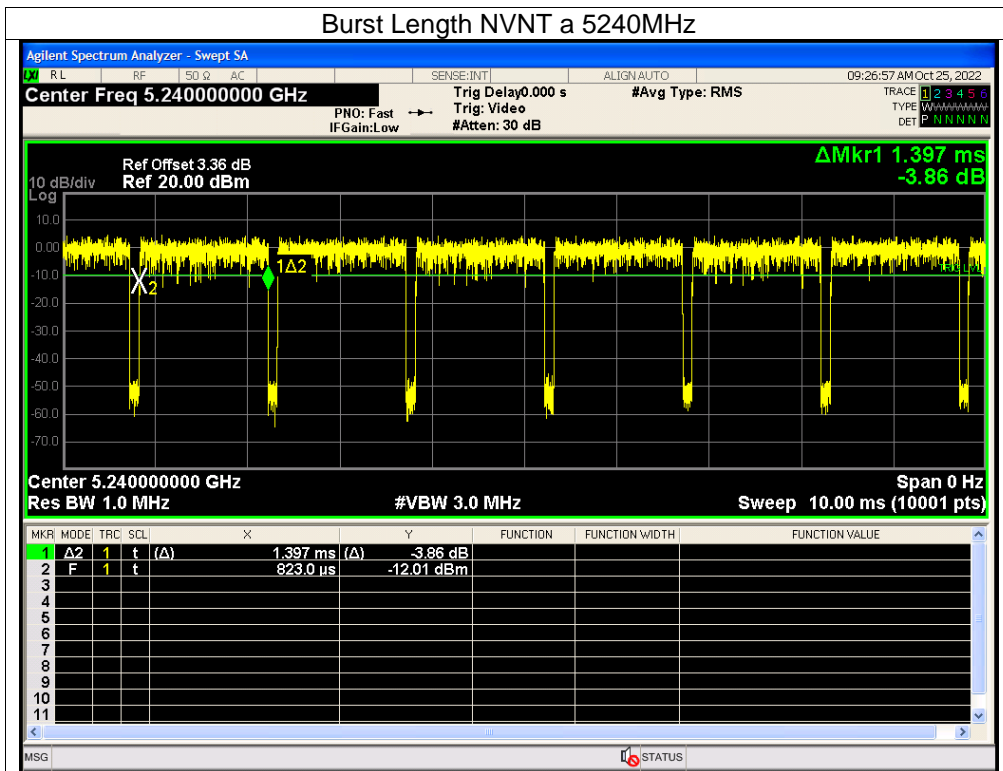

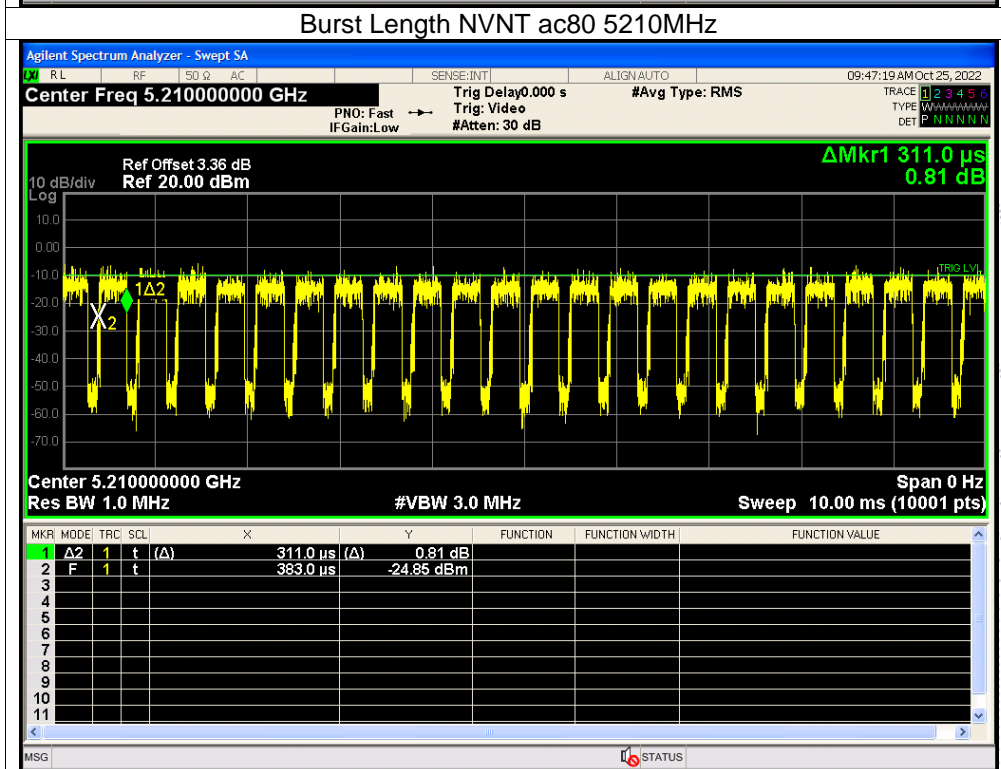
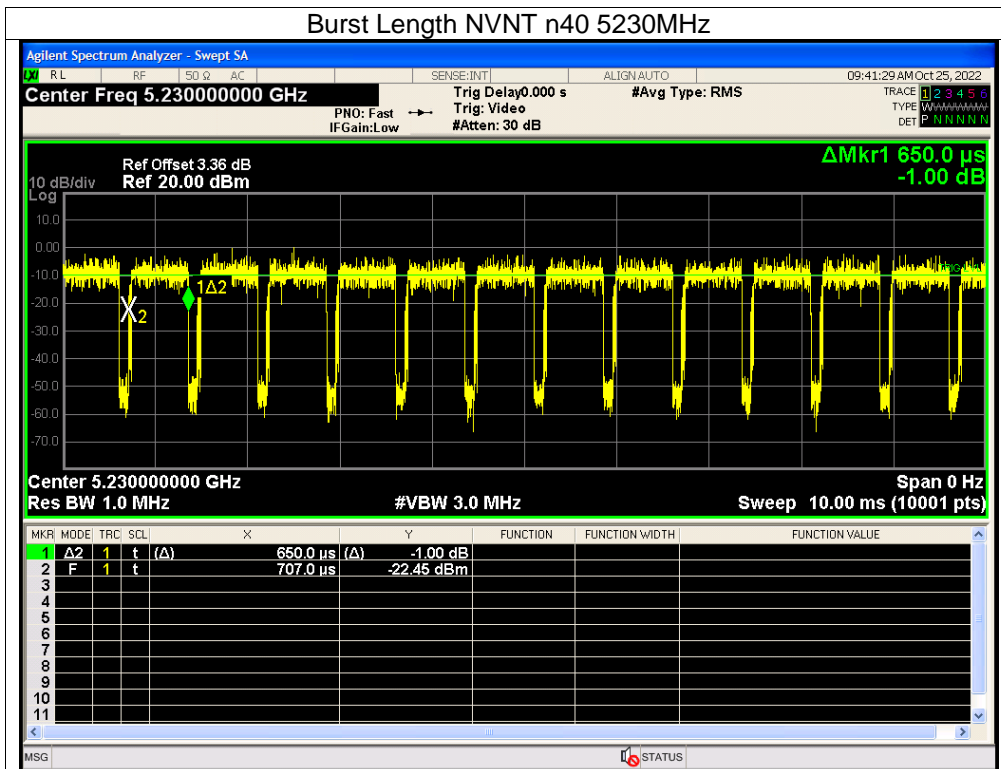

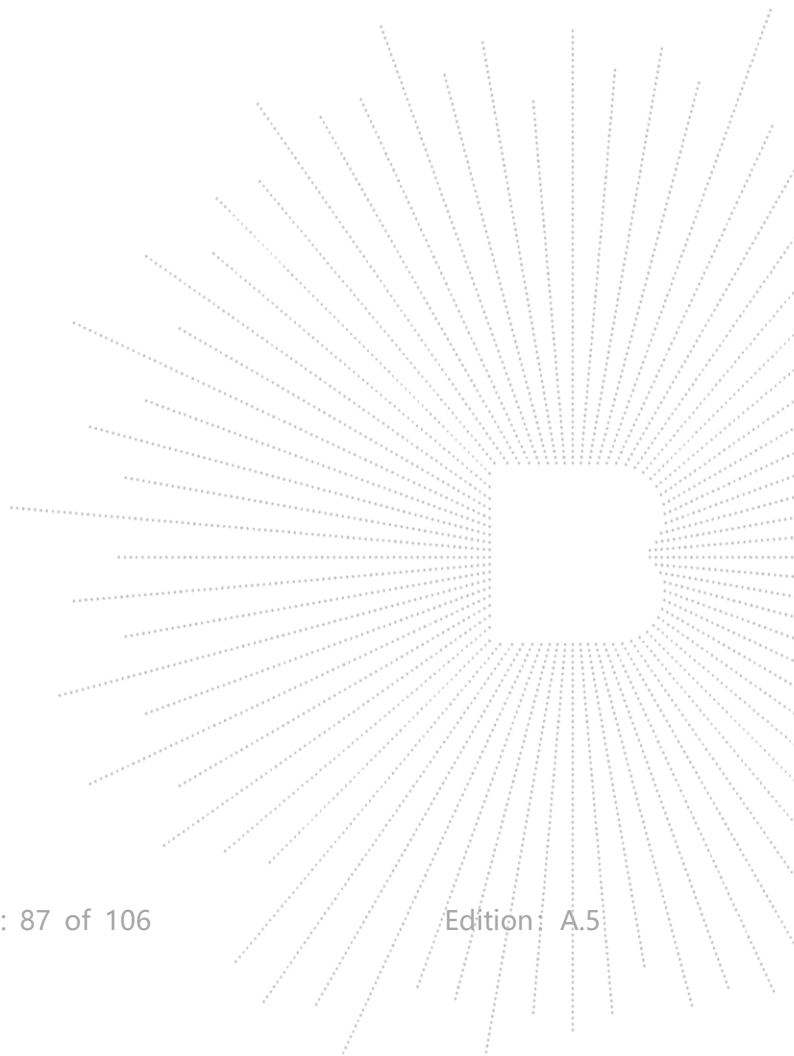
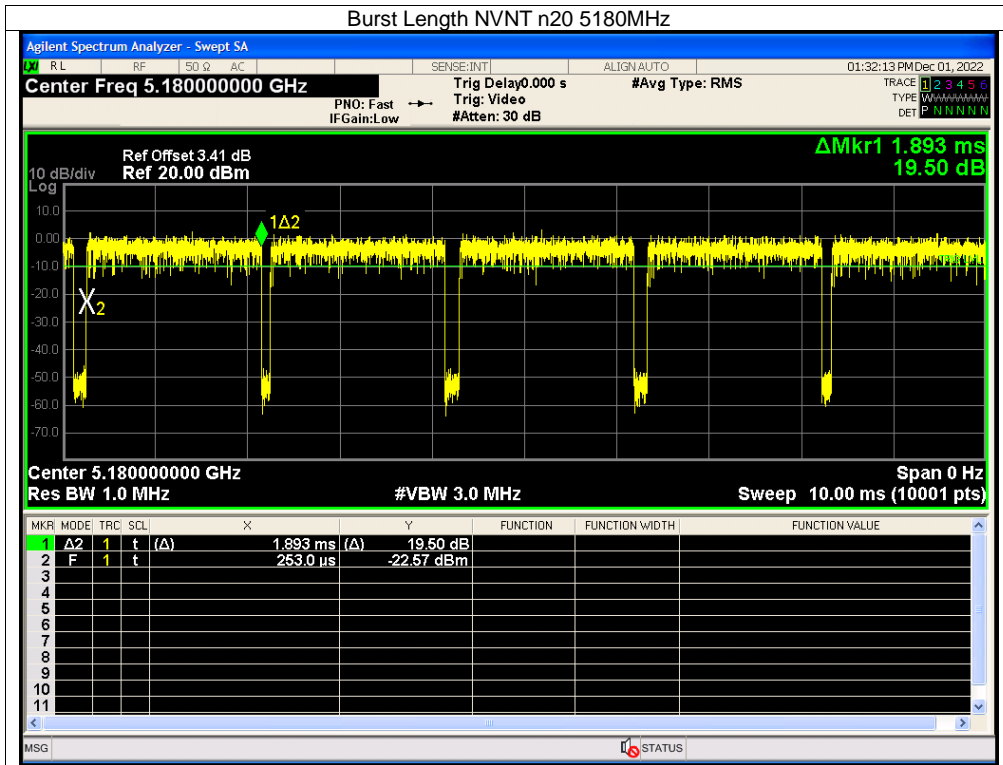

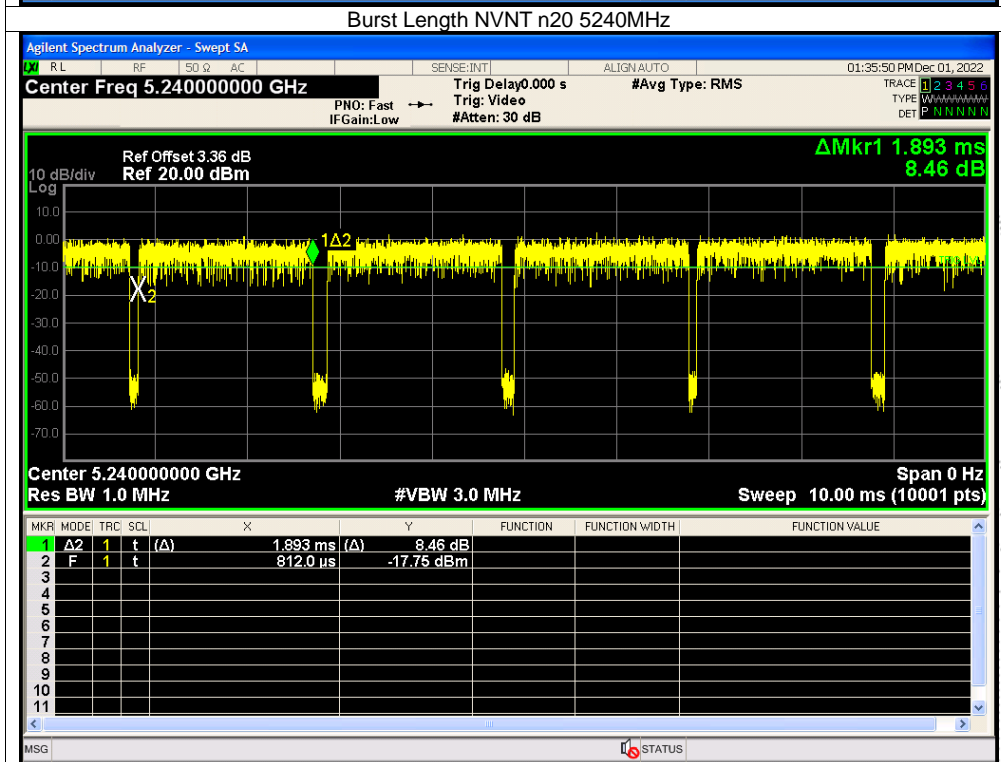
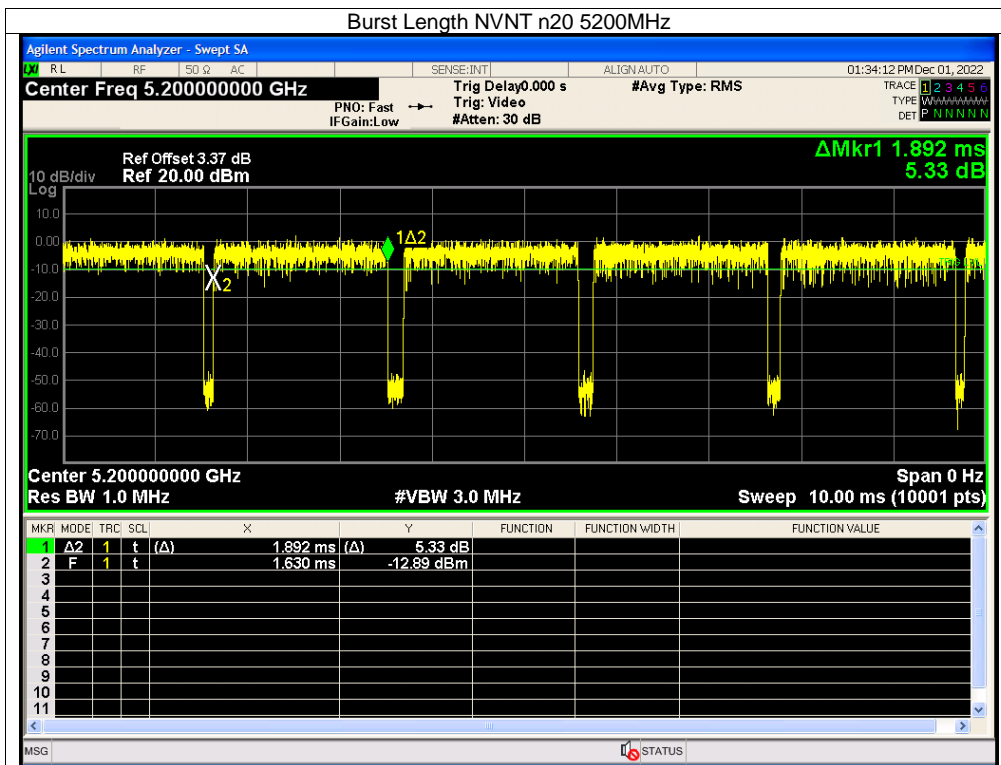

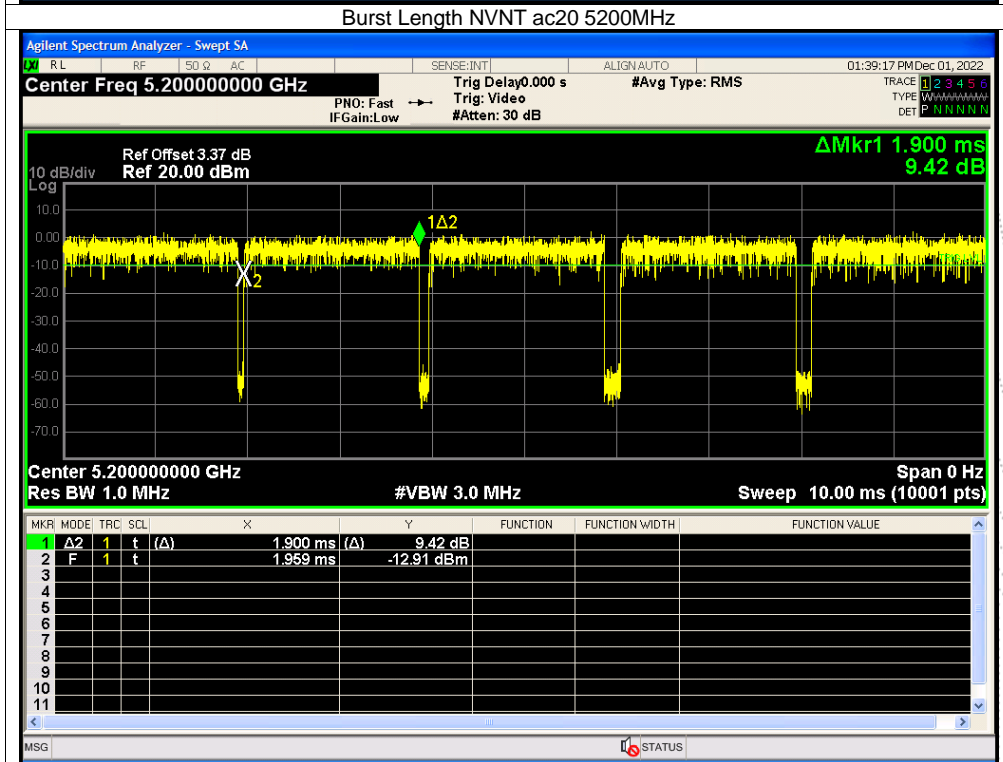
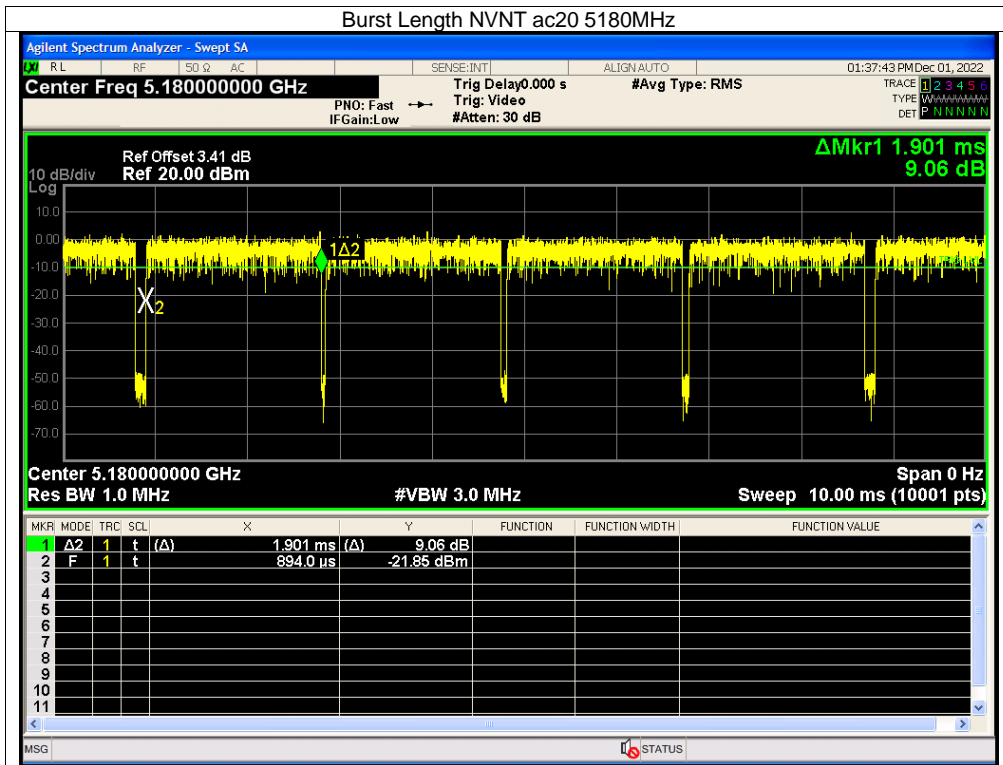

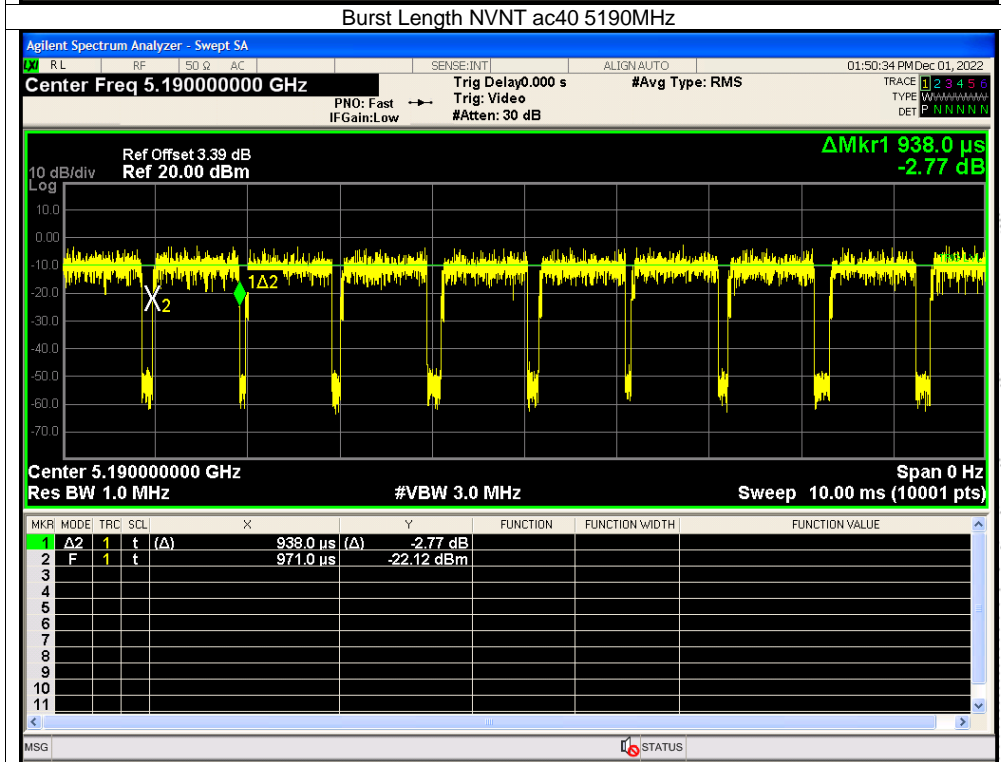
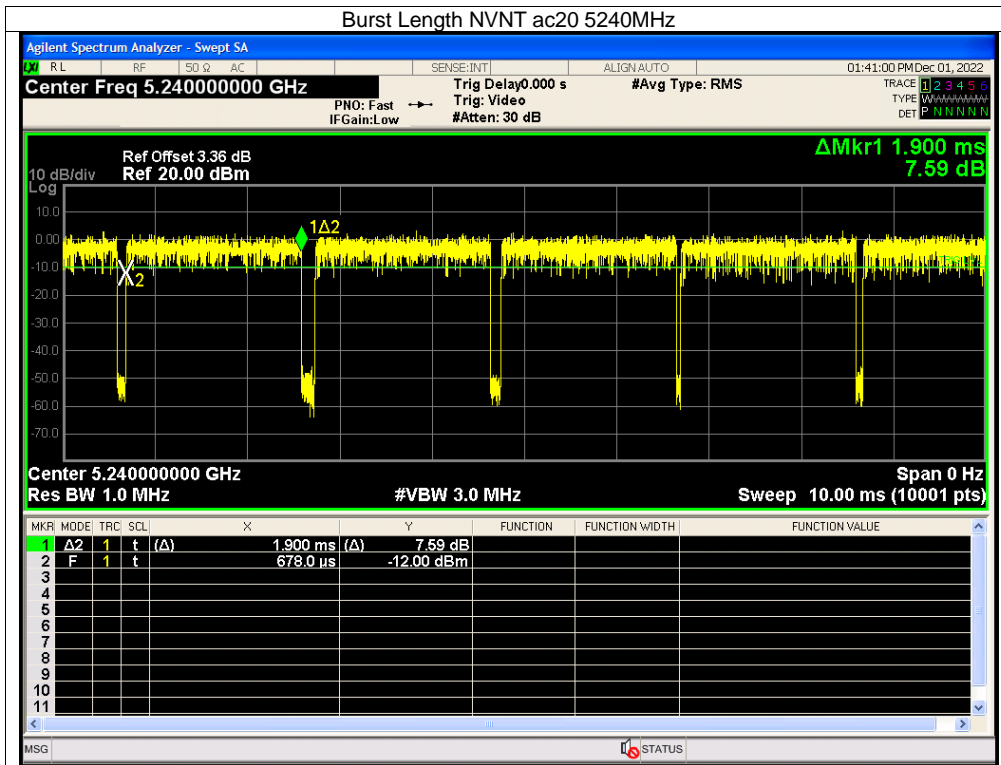

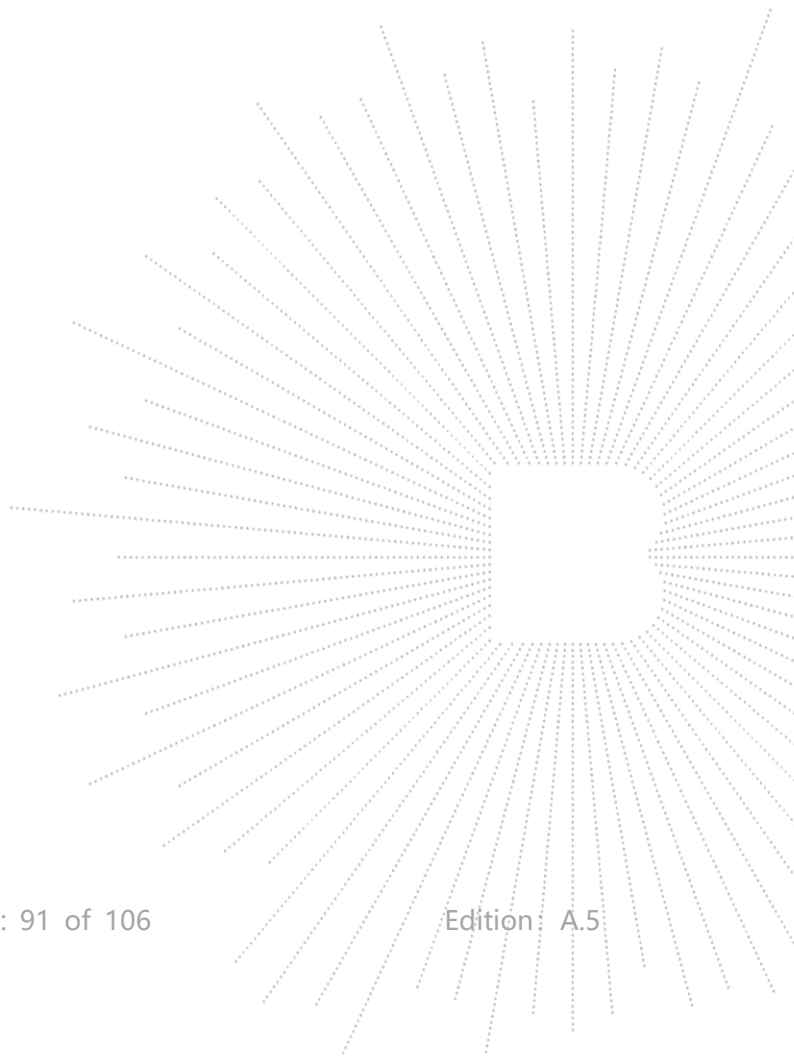
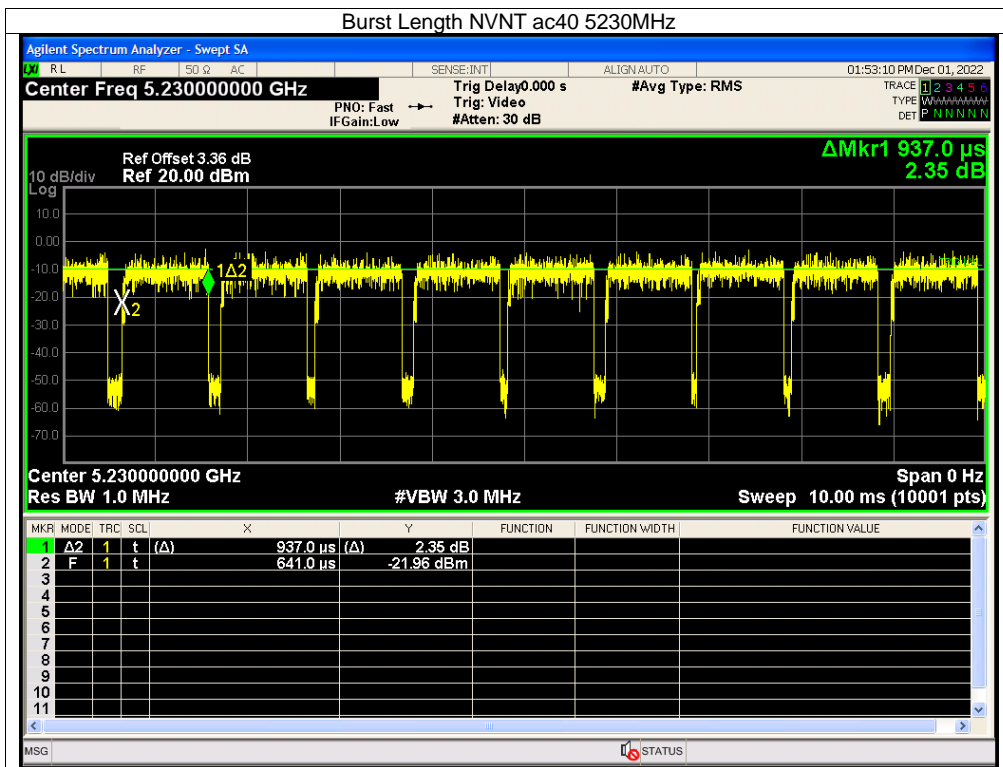

13. Interference Prevention Function Measurement

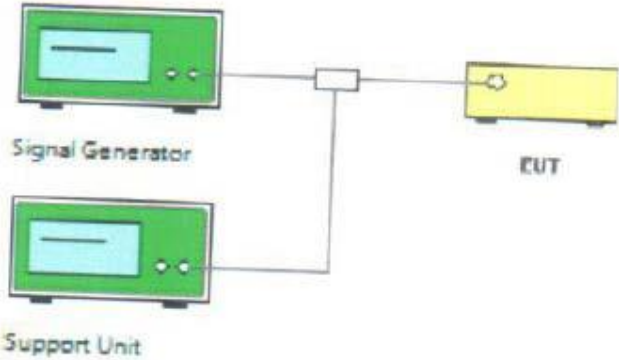
Test condition:	Test diffusion code and modulate with standard coding test signal
Test setup:	 <p>The diagram illustrates the test setup. A green 'Signal Generator' is connected to a yellow 'EUT' (Equipment Under Test) via a cable. A second green 'Support Unit' is also connected to the same cable between the Signal Generator and the EUT, likely providing a reference or control signal.</p>
Test Procedures:	<ol style="list-style-type: none"> 1. The EUT continuous connected with support unit. 2. Signal generator transmitted interference signal to the EUT. 3. Check the EUT must be automatic cessation of transmitting
Test Instruments:	Refer to section 5.2 for details
Test results:	<p>Pass</p> <p>Transmitter: The transmitting mode (the identification code is more than 48 bits) of EUT is on normal operating, the interference prevention function is good.</p> <p>Receiver: The transmitting mode of EUT is on normal operating, the interference prevention function is good.</p>
Mac address:	00:0a:f5:f0:11:4e

14. Carrier Sense Capability Measurement

14.1 Block Diagram Of Test Setup

(1) Test performed with the radio equipment to be tested only

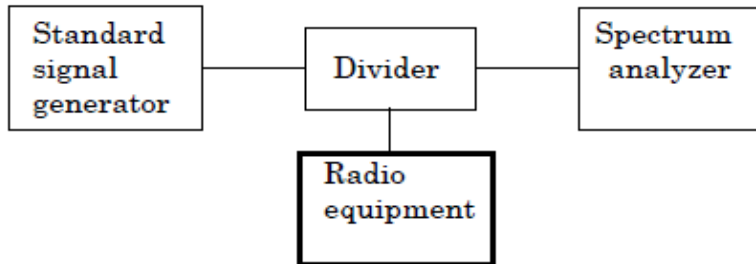

(2) Test performed using the external radio equipment

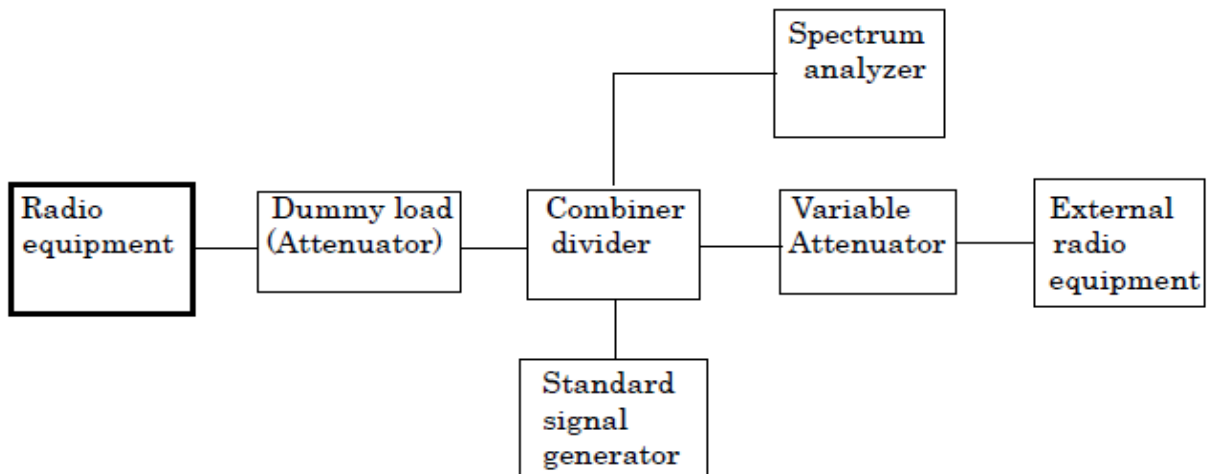

14.2 Limit

EUT stop RF transmission signal after carrier inject to EUT.

14.3 Test Procedure

- (1) Test performed with the radio equipment to be tested only
- A. Set the standard signal generator in non-transmission condition and the radio equipment to be tested in transmission condition, and confirm transmission of radiowave by means of the spectrum analyzer.
 - B. Set the radio equipment to be tested in receiving condition.
 - C. Set the standard signal generator in transmission condition and the radio equipment to be tested in transmission condition, and confirm non-transmission of radiowave by means of the spectrum analyzer.

(2) Test performed using the external radio equipment

- A. Set the standard signal generator in non-transmission condition.
- B. Connect the radio equipment to be tested with the external equipment by means of the line and confirm transmission of radiowave of test frequency by means of the spectrum analyzer.
- C. Set the radio equipment to be tested in receiving condition.
- D. Set the standard signal generator in transmission condition and the radio equipment to be tested in transmission condition, and confirm non-transmission of radiowave by means of the spectrum analyzer.

Note: SG adjusted the frequency as same as the EUT transmitted signal and emitted the absence of modulation from SG and power level is $(on\ 22.79+G-20*\log(f)\text{dBm})$ (G is the antenna gain, f is the test frequency).

14.5 Test Result

(1) RESULT

Mode	Channel	Result		
		Normal Voltage	High Voltage	Low Voltage
802.11a	CH36	Pass	Pass	Pass
	CH40	Pass	Pass	Pass
	CH48	Pass	Pass	Pass
802.11n20	CH36	Pass	Pass	Pass
	CH40	Pass	Pass	Pass
	CH48	Pass	Pass	Pass
802.11n40	CH38	Pass	Pass	Pass
	CH46	Pass	Pass	Pass
802.11ac20	CH36	Pass	Pass	Pass
	CH40	Pass	Pass	Pass
	CH48	Pass	Pass	Pass
802.11nac40	CH38	Pass	Pass	Pass
	CH46	Pass	Pass	Pass
802.11ac80	CH42	Pass	Pass	Pass

Result:OK

15. Adjacent Channel Emitted Power Measurement

15.1 Block Diagram Of Test Setup

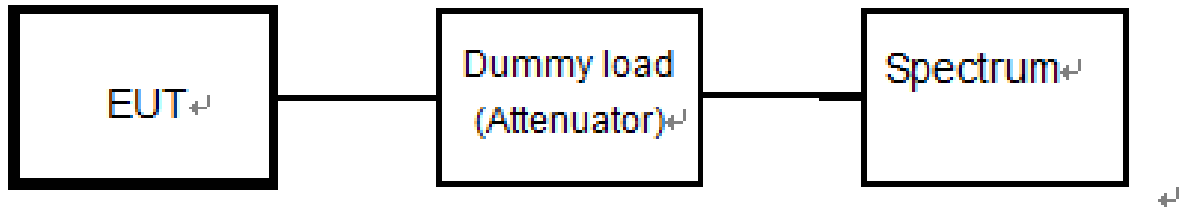

15.2 Limit

802.11a	802.11n20/ac20
$F_c \pm 20\text{MHz} \pm 9\text{MHz BW} : -25\text{dBc}$ $F_c \pm 40\text{MHz} \pm 9\text{MHz BW} : -40\text{dBc}$	$F_c \pm 20\text{MHz} \pm 9.5\text{MHz BW} : -25\text{dBc}$ $F_c \pm 40\text{MHz} \pm 9.5\text{MHz BW} : -40\text{dBc}$
802.11n40/ac40	802.11ac80
$F_c \pm 40\text{MHz} \pm 19\text{MHz BW} : -25\text{dBc}$ $F_c \pm 80\text{MHz} \pm 19\text{MHz BW} : -40\text{dBc}$	$F_c \pm 80\text{MHz} \pm 39\text{MHz BW} : -20\text{dBc}$

15.3 Measuring Instruments And Setting

Please refer to section 5 in this report. The following table is the setting of Spectrum Analyzer.

Spectrum Parameter	Setting
Center frequency	Frequency indicated in the test procedure
Sweep frequency width	120MHz(20MHz system); 240MHz(40MHz system); 480MHz(80MHz system);
Resoluble bandwidth	300kHz
Video bandwidth	300kHz
Y-axis scale	10dB/Div.
Input level	Value to be maximum dynamic range
Data points	More than 400 points
Sweep mode	Continuous sweep
Detection mode	Sample (Positive peak in case of burst wave)

15.4 Test Result

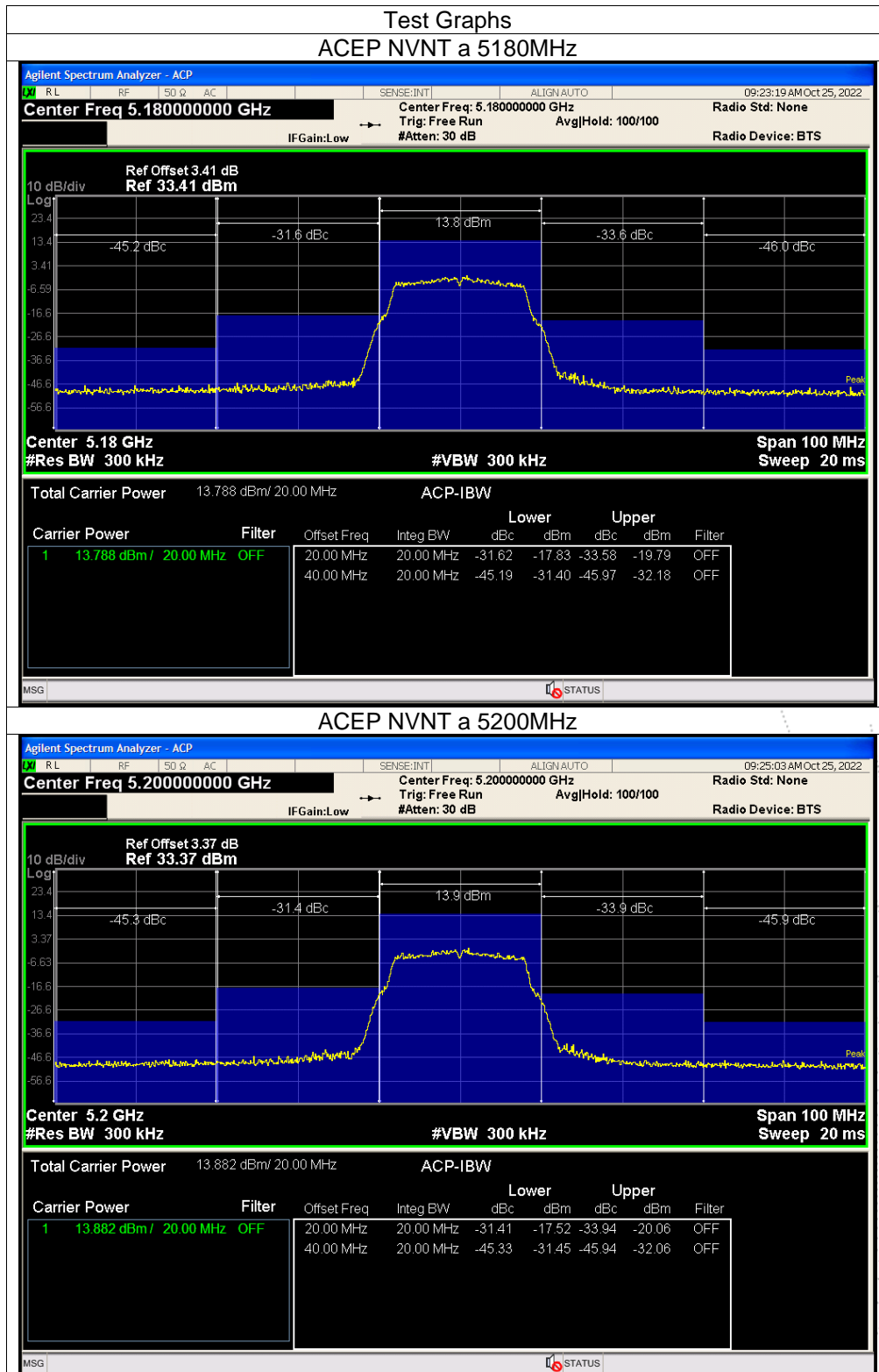

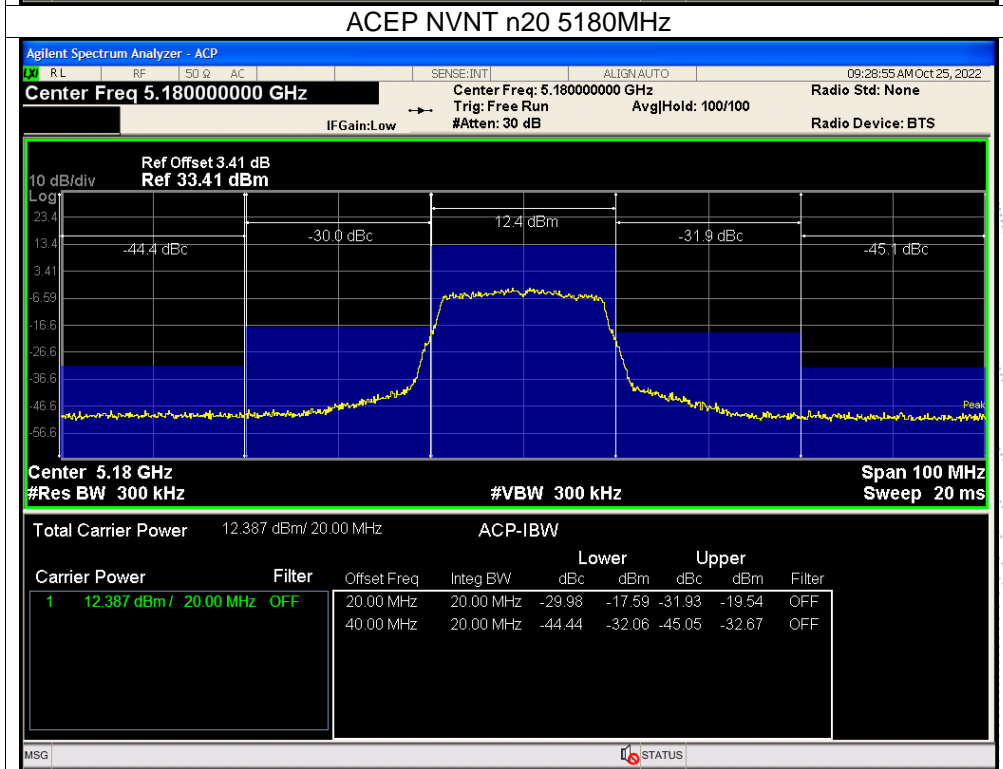
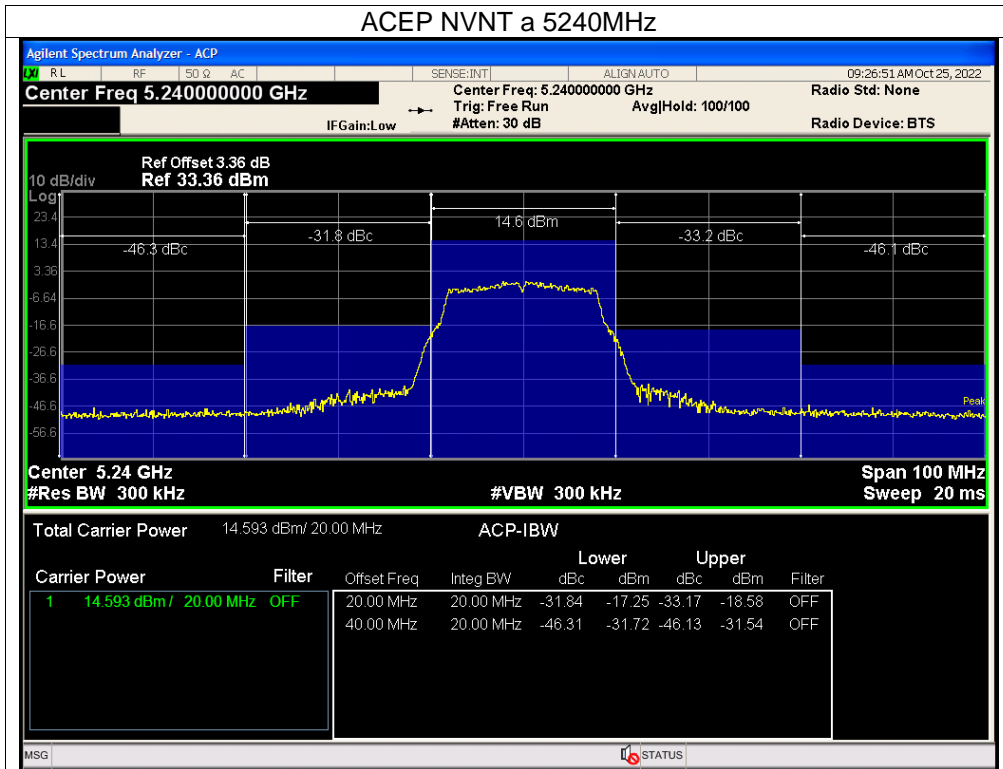

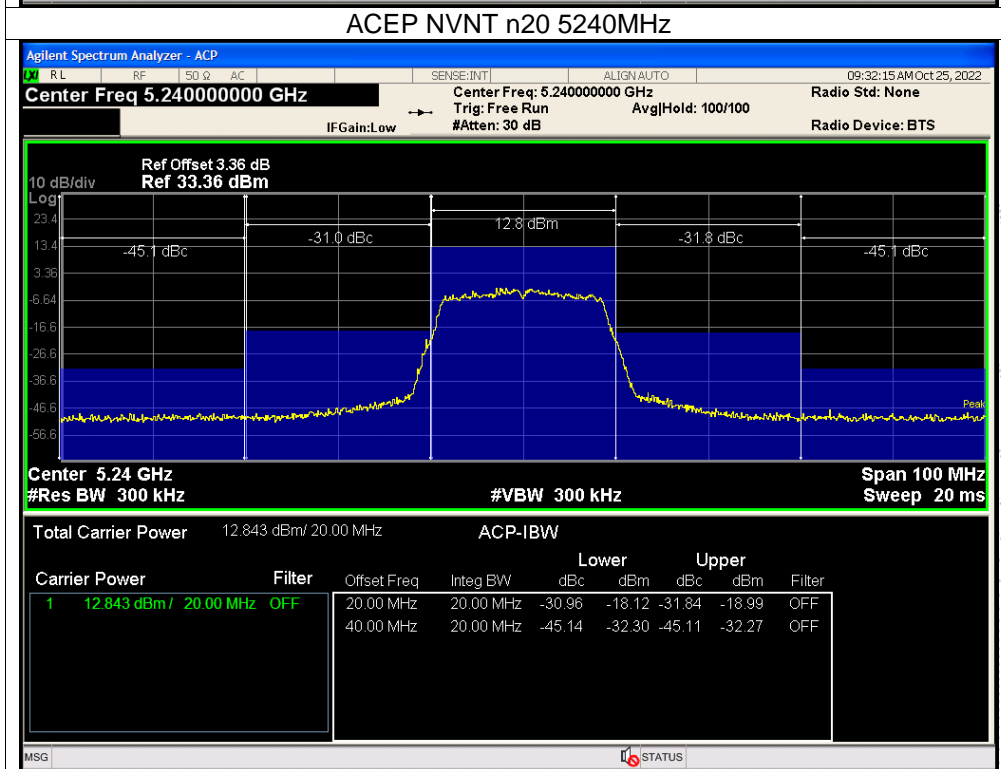
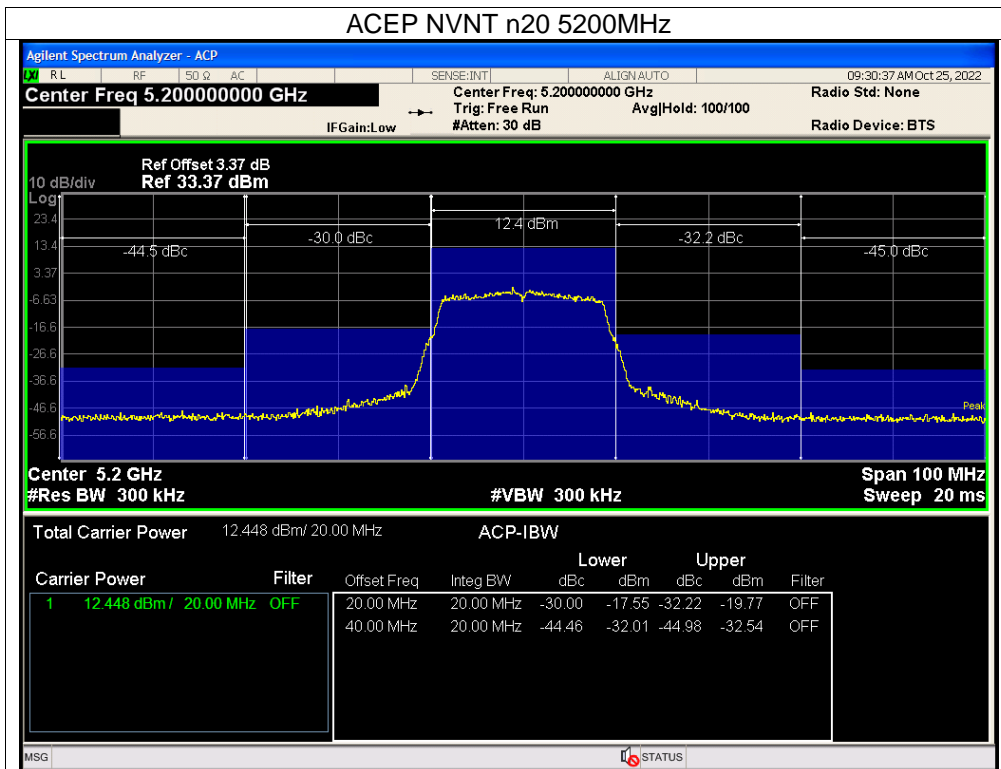

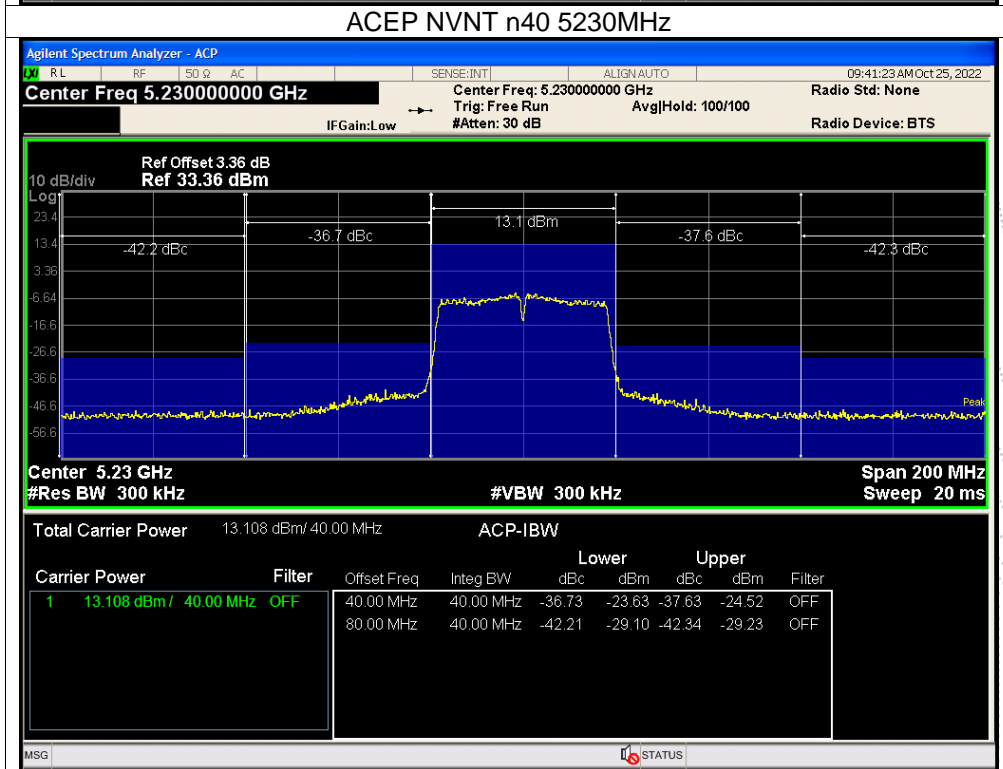
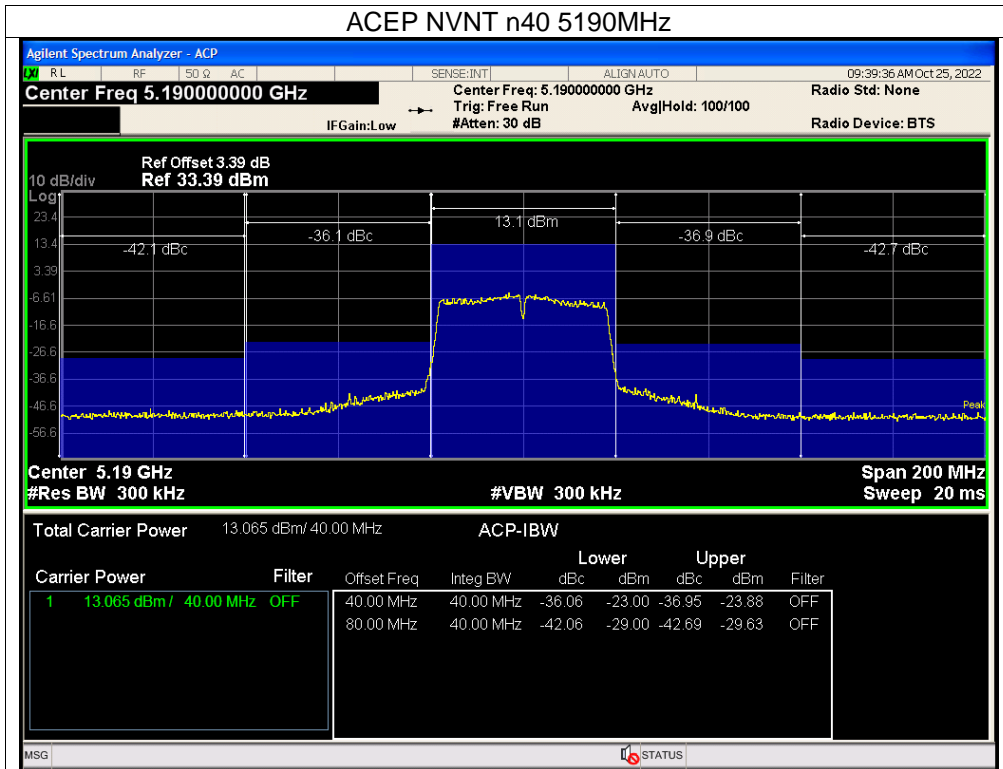

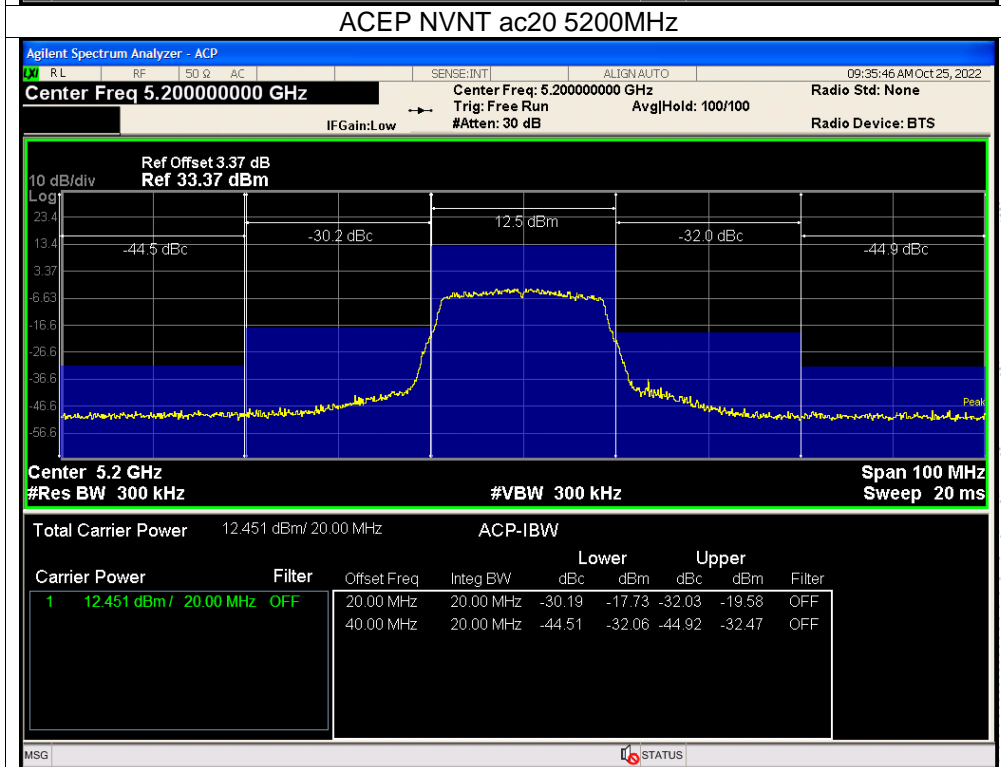
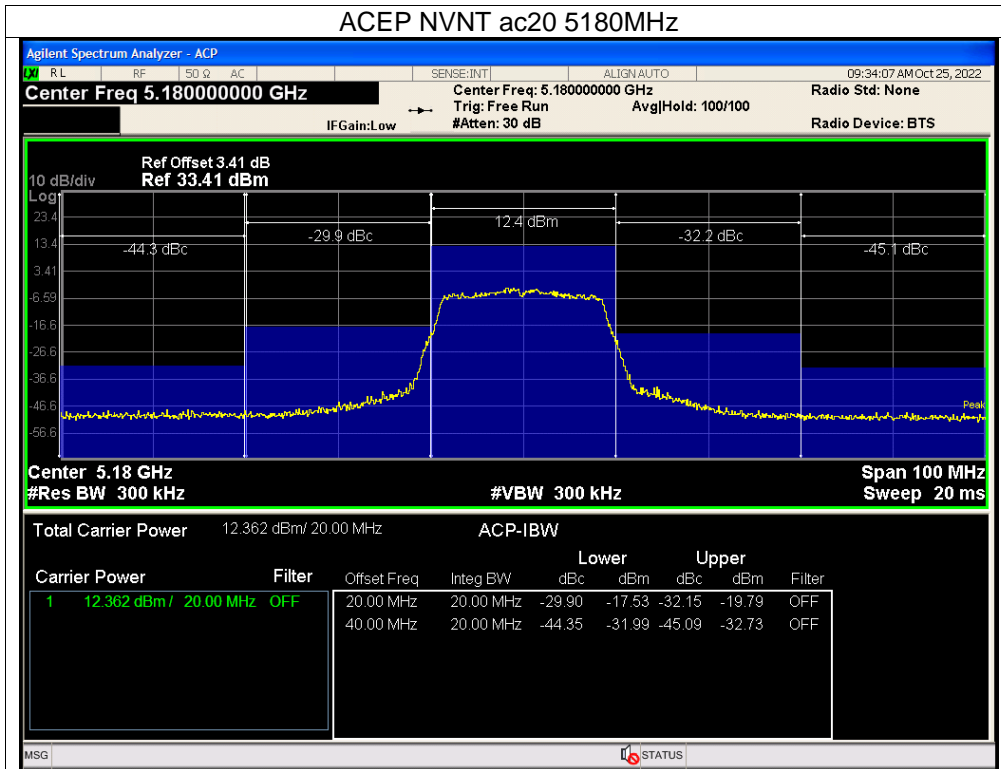

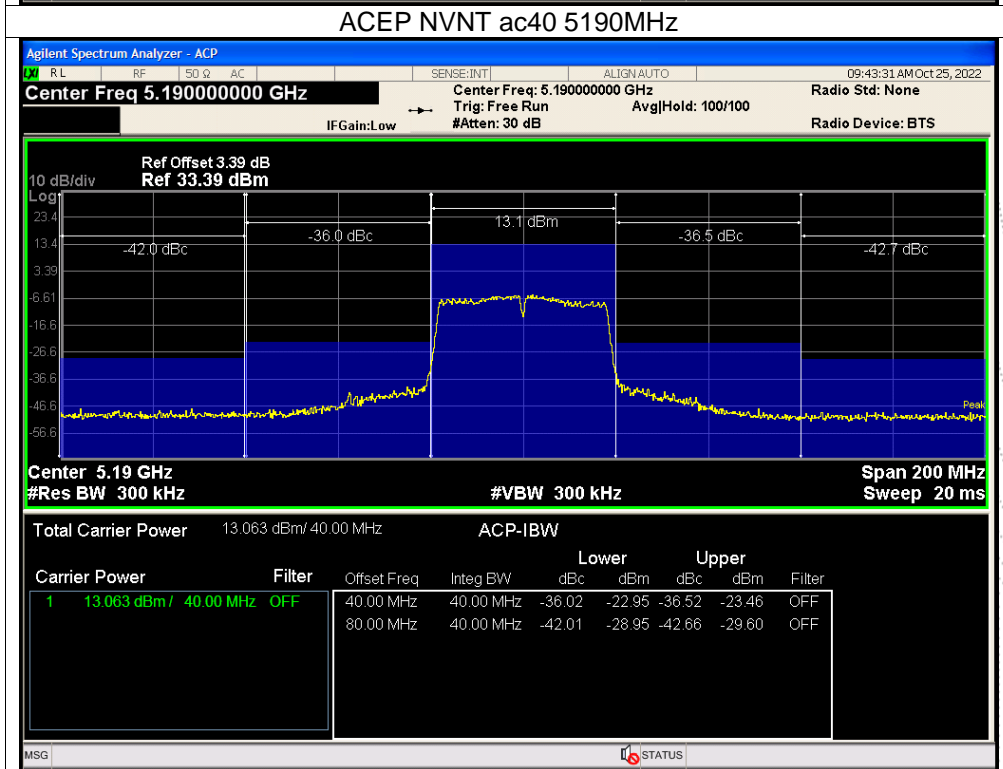
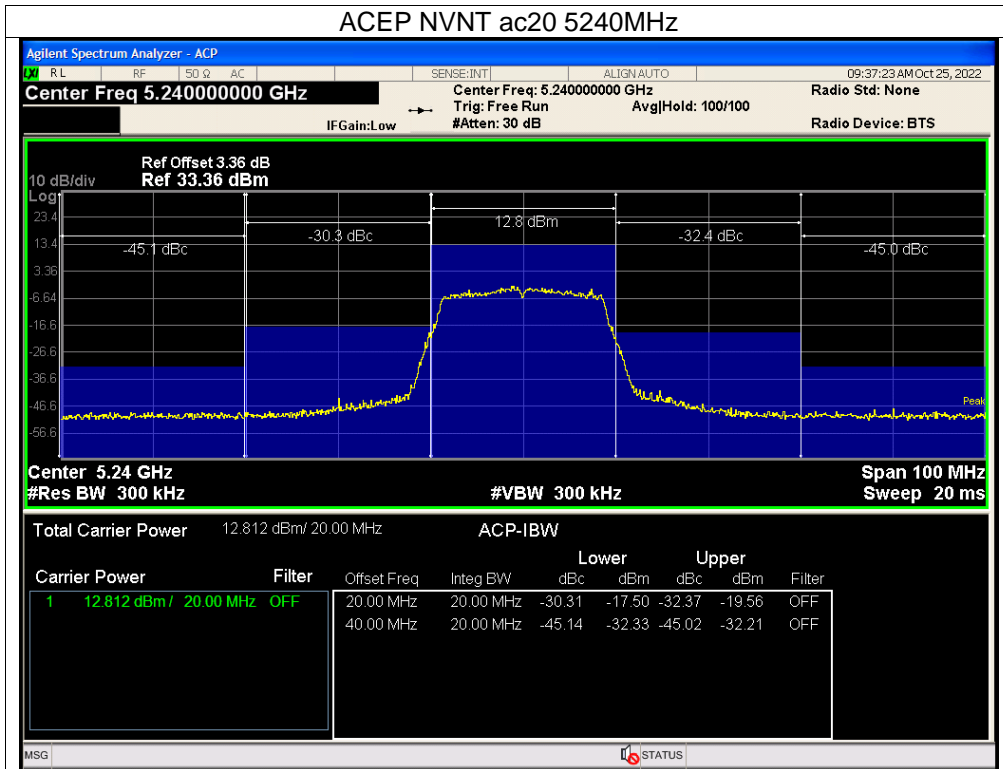

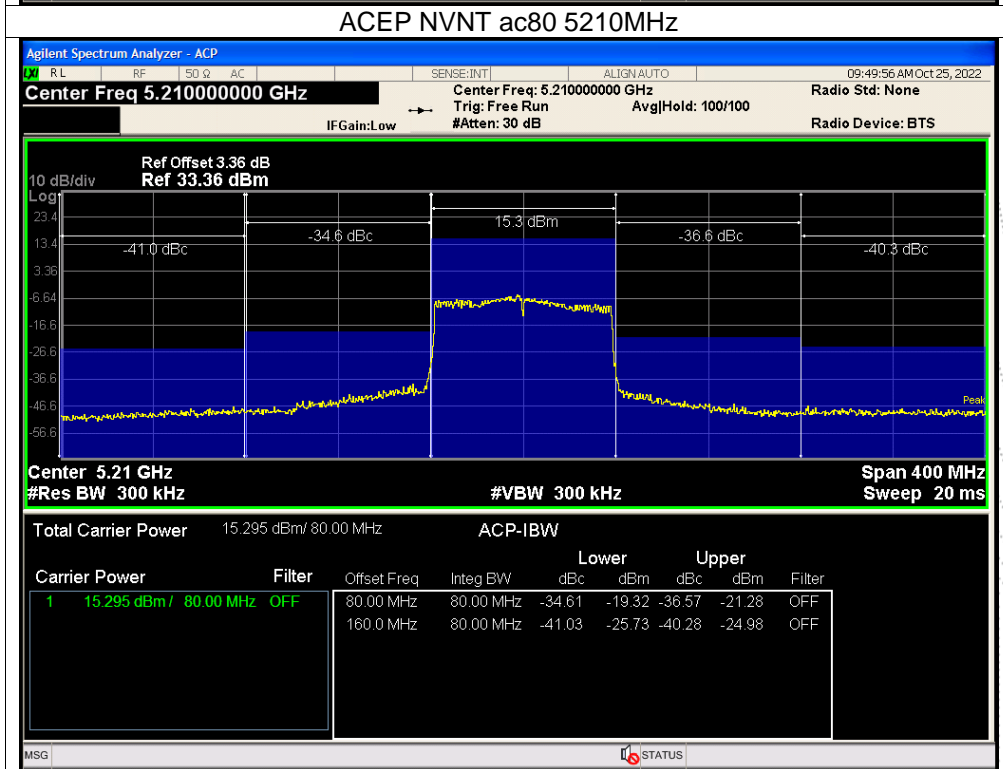
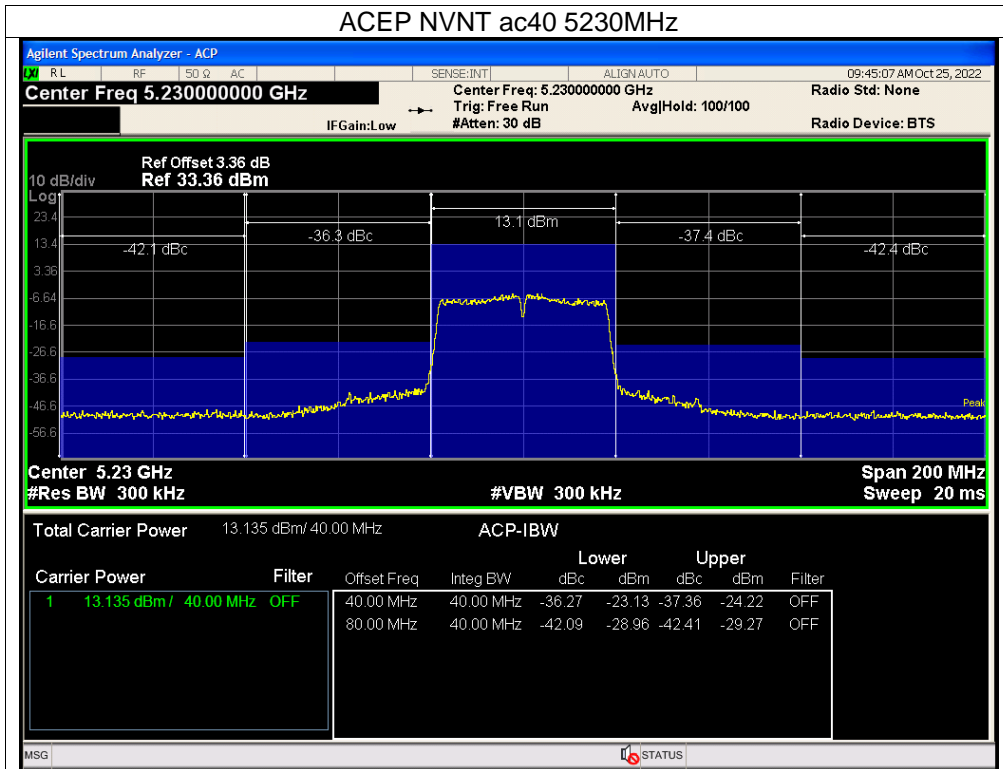

16. EUT Photographs

EUT Photo 1

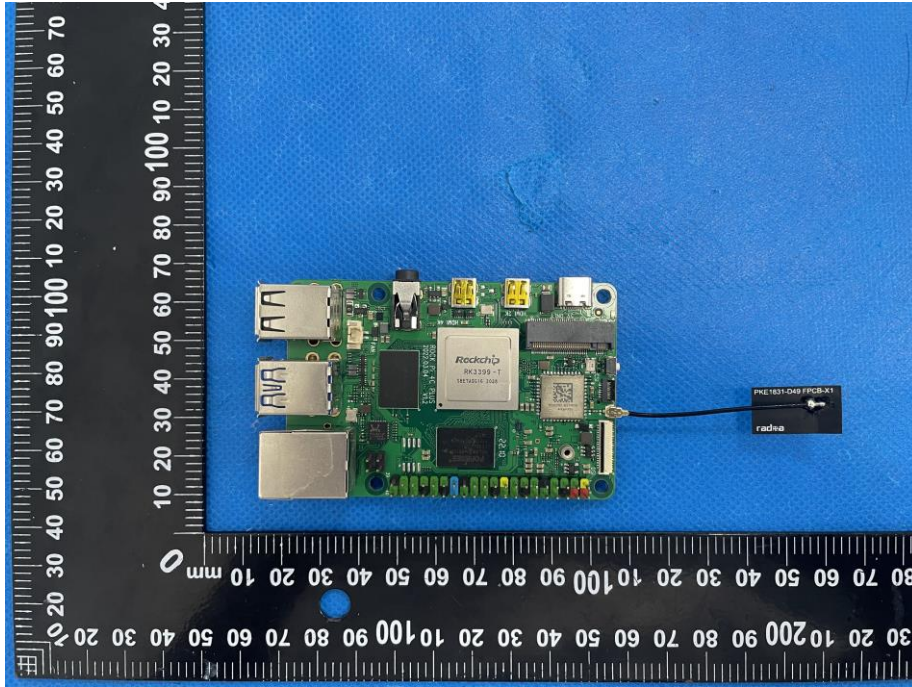

EUT Photo 2

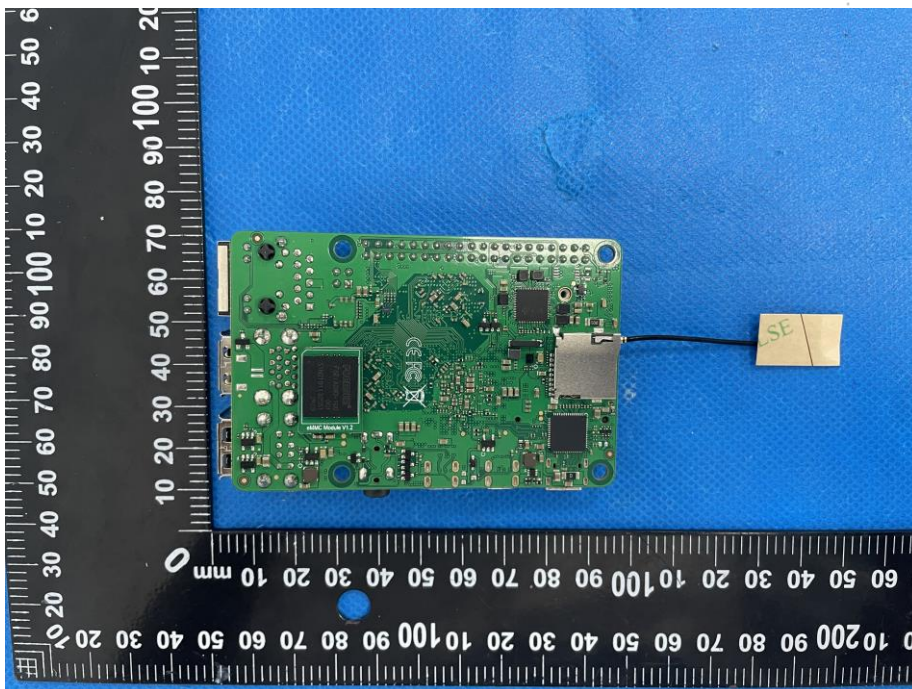

EUT Photo 3

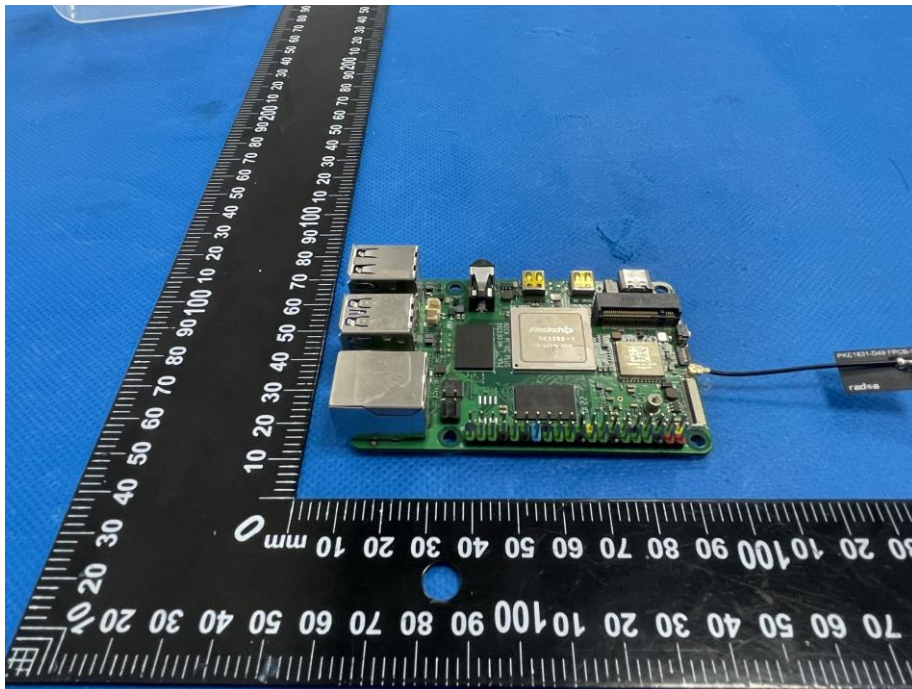

EUT Photo 4

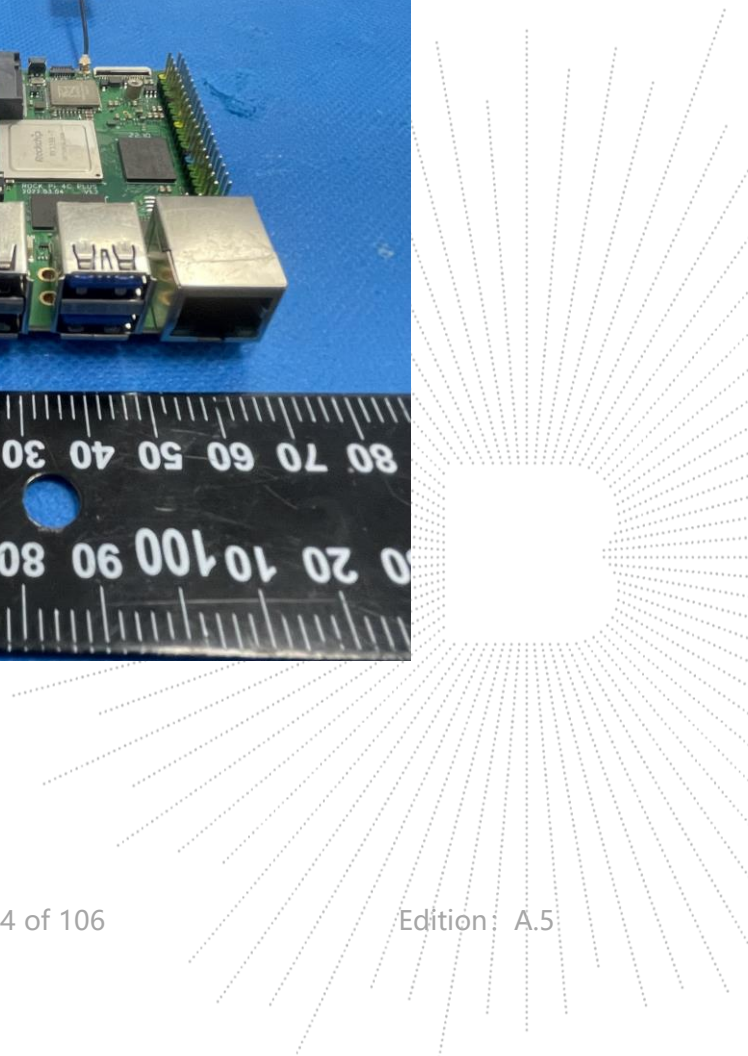
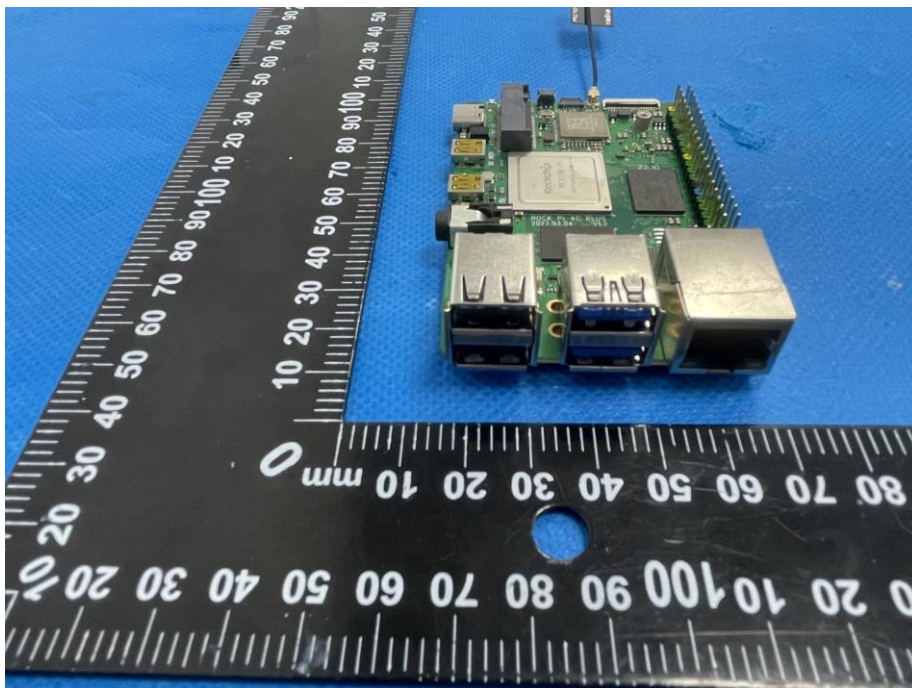

17. EUT Test Setup Photographs

Measurement Photos

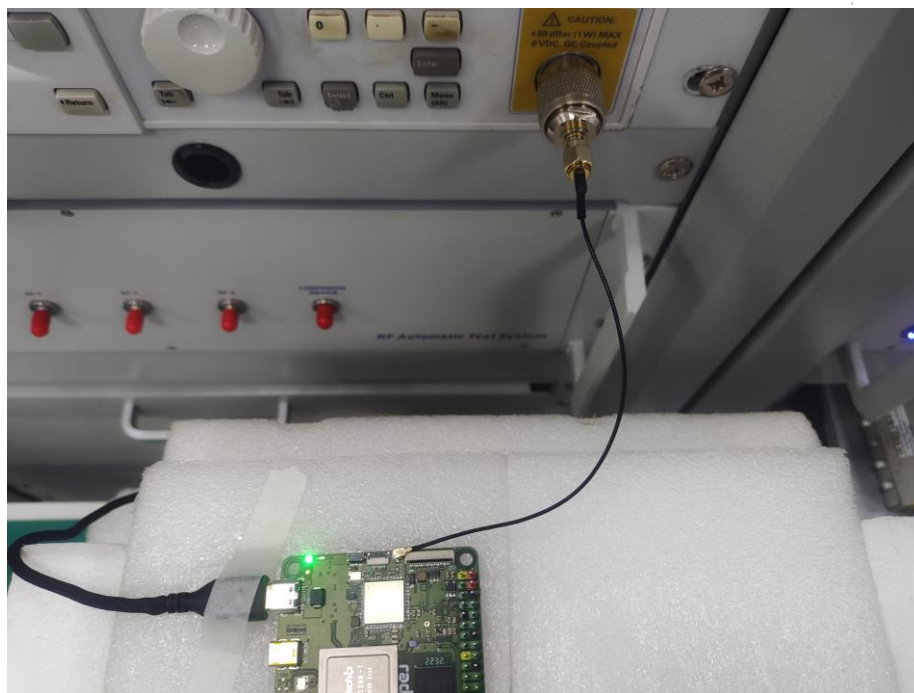
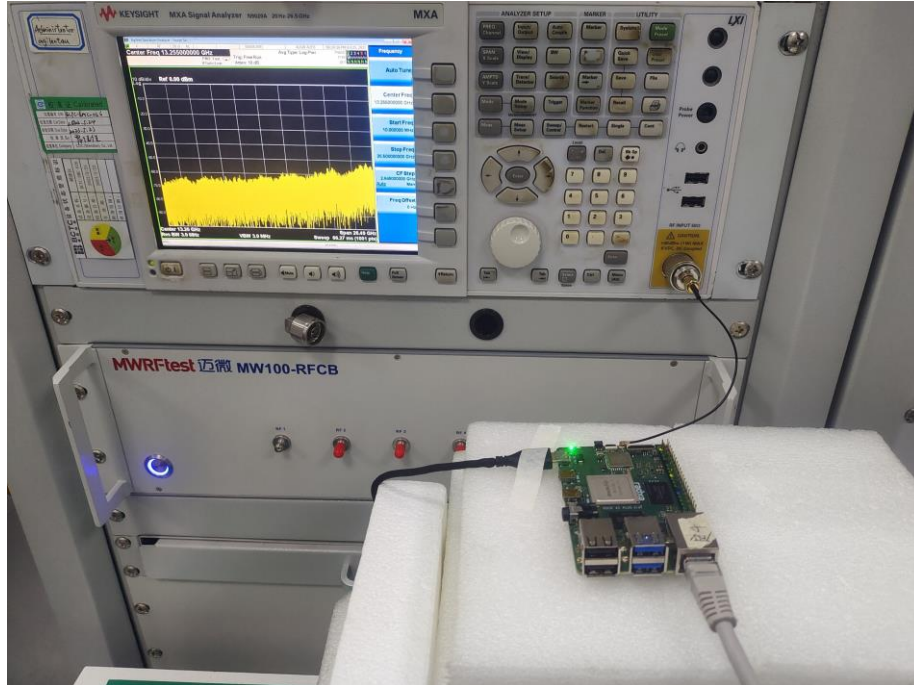

STATEMENT

1. The equipment lists are traceable to the national reference standards.
2. The test report can not be partially copied unless prior written approval is issued from our lab.
3. The test report is invalid without the "special seal for inspection and testing".
4. The test report is invalid without the signature of the approver.
5. The test process and test result is only related to the Unit Under Test.
6. Sample information is provided by the client and the laboratory is not responsible for its authenticity.
7. The test report without CMA mark is only used for scientific research, teaching, enterprise product development and internal quality control purposes.
8. The quality system of our laboratory is in accordance with ISO/IEC17025.
9. If there is any objection to this test report, the client should inform issuing laboratory within 15 days from the date of receiving test report.

Address:

1-2/F., Building B, Pengzhou Industrial Park, No.158, Fuyuan 1st Road, Zhancheng, Fuhai Subdistrict, Bao'an District, Shenzhen, Guangdong, China

TEL: 400-788-9558

P.C.: 518103

FAX: 0755-33229357

Website: <http://www.chnbctc.com>

E-Mail: bctc@bctc-lab.com.cn

***** END *****

