

# TEST REPORT

Report No.: BCTC2210342658-1E

---

Applicant: OKdo Technology Limited

---

Product Name: ROCK Pi 4/ROCK 4

---

Model/Type Ref.: ROCK 4 SE

---

Tested Date: 2022-10-21 to 2022-12-06

---

Issued Date: 2022-12-07

---

**Shenzhen BCTC Testing Co., Ltd.**



SHENZHEN

# IC: 29530-ROCK4SE

Product Name: ROCK Pi 4/ROCK 4  
Trademark: N/A  
Model/Type Ref.: ROCK 4 SE  
Prepared For: OKdo Technology Limited  
Address: 5th Floor, 2 Pancras Square, King's Cross, London N1C 4AG, United Kingdom  
Manufacturer: OKdo Technology Limited  
Address: 5th Floor, 2 Pancras Square, King's Cross, London N1C 4AG, United Kingdom  
Prepared By: Shenzhen BCTC Testing Co., Ltd.  
Address: 1-2/F., Building B, Pengzhou Industrial Park, No.158, Fuyuan 1st Road, Zhancheng, Fuhai Subdistrict, Bao'an District, Shenzhen, Guangdong, China  
Sample Received Date: 2022-10-21  
Sample tested Date: 2022-10-21 to 2022-12-06  
Issue Date: 2022-12-07  
Report No.: BCTC2210342658-1E  
Test Standards: RSS-247 Issue 2: February 2017  
RSS-Gen Issue 5: Amendment 2 (February 2021)  
558074 D01 15.247 Meas Guidance v05r02  
ANSI C63.10:2013  
Test Results: PASS  
Remark: This is Bluetooth Classic radio test report.

Tested by:

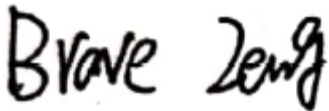

Brave Zeng/ Project Handler

Approved by:



Zero Zhou/Reviewer

The test report is effective only with both signature and specialized stamp. This result(s) shown in this report refer only to the sample(s) tested. Without written approval of Shenzhen BCTC Testing Co., Ltd, this report can't be reproduced except in full. The tested sample(s) and the sample information are provided by the client.

## Table Of Content

Test Report Declaration	Page
1. Version .....	5
2. Test Summary .....	6
3. Measurement Uncertainty .....	7
4. Product Information And Test Setup .....	8
4.1 Product Information.....	8
4.2 Test Setup Configuration .....	8
4.3 Support Equipment .....	8
4.4 Channel List.....	10
4.5 Test Mode .....	10
4.6 Table Of Parameters Of Text Software Setting.....	10
5. Test Facility And Test Instrument Used.....	11
5.1 Test Facility.....	11
5.2 Test Instrument Used.....	11
6. Conducted Emissions.....	13
6.1 Block Diagram Of Test Setup.....	13
6.2 Limit .....	13
6.3 Test Procedure .....	13
6.4 EUT Operating Conditions .....	13
6.5 Test Result.....	14
7. Radiated Emissions.....	16
7.1 Block Diagram Of Test Setup.....	16
7.2 Limit .....	17
7.3 Test Procedure .....	18
7.4 EUT Operating Conditions .....	19
7.5 Test Result.....	19
8. Radiated Band Emission Measurement And Restricted Bands Of Operation .....	25
8.1 Block Diagram Of Test Setup.....	25
8.2 Limit .....	25
8.3 Test Procedure .....	26
8.4 EUT Operating Conditions .....	26
8.5 Test Result.....	27
9. Conducted Emission .....	28
9.1 Block Diagram Of Test Setup.....	28
9.2 Limit .....	28
9.3 Test Procedure .....	28
9.4 Test Result.....	29
10. 20 DB Bandwidth.....	50
10.1 Block Diagram Of Test Setup.....	50
10.2 Limit .....	50
10.3 Test Procedure .....	50
10.4 Test Result.....	51
11. Maximum Peak Output Power.....	62
11.1 Block Diagram Of Test Setup.....	62

11.2	Limit .....	62
11.3	Test Procedure .....	62
11.4	Test Result.....	63
12.	Hopping Channel Separation .....	69
12.1	Block Diagram Of Test Setup.....	69
12.2	Limit .....	69
12.3	Test Procedure .....	69
12.4	Test Result.....	69
13.	Number Of Hopping Frequency.....	75
13.1	Block Diagram Of Test Setup.....	75
13.2	Limit .....	75
13.3	Test Procedure .....	75
13.4	Test Result.....	76
14.	Dwell Time.....	78
14.1	Block Diagram Of Test Setup.....	78
14.2	Limit .....	78
14.3	Test Procedure .....	78
14.4	Test Result.....	78
15.	Antenna Requirement .....	84
15.1	Limit .....	84
15.2	Test Result.....	84
16.	EUT Photographs.....	85
17.	EUT Test Setup Photographs.....	86

(Note: N/A Means Not Applicable)

TE  
TC  
OVB  
檢

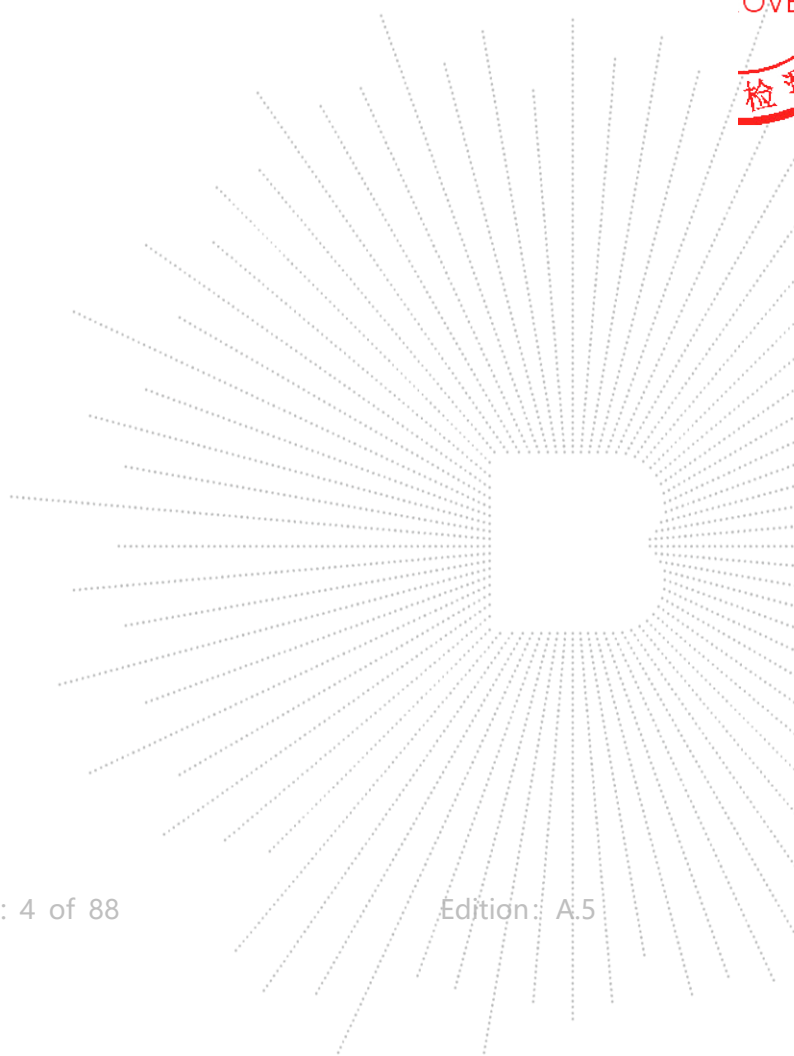

**1. Version**

Report No.	Issue Date	Description	Approved
BCTC2210342658-1E	2022-12-07	Original	Valid

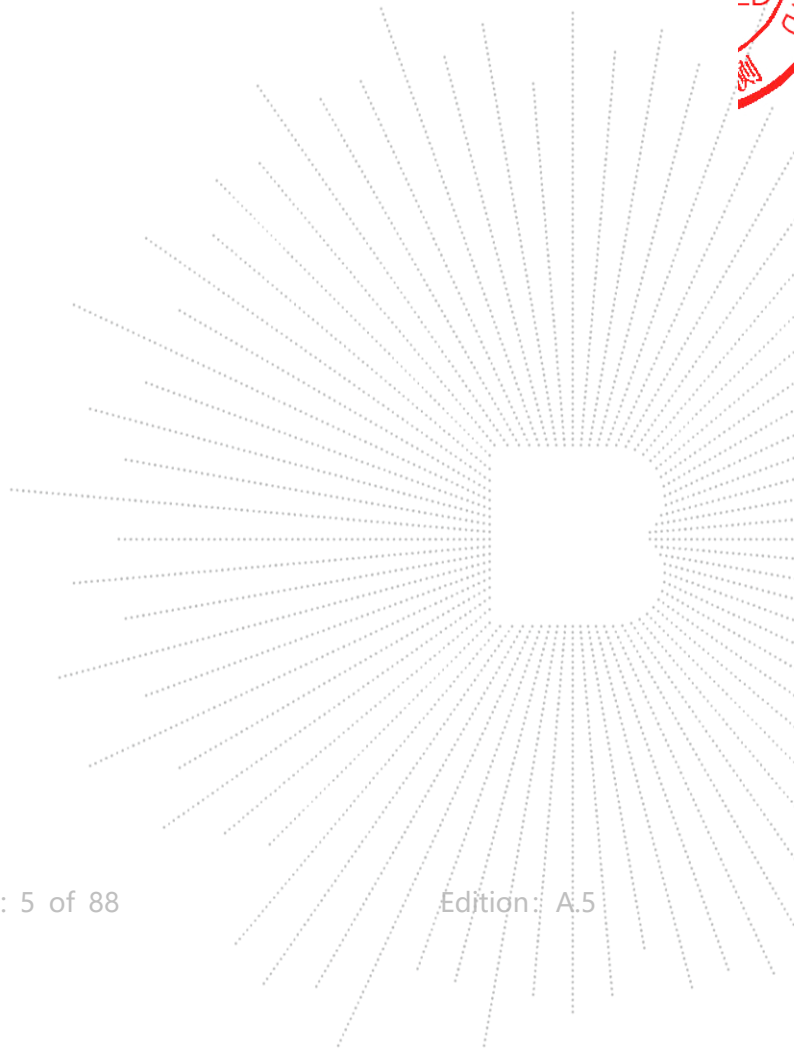

## 2. Test Summary

The Product has been tested according to the following specifications:

No.	Test Parameter	Clause No	Results
1	Conducted emission AC power port	RSS-GEN 8.8	PASS
2	Conducted peak output power for FHSS	RSS-247 Clause 5.4(b)	PASS
3	99% Occupied Bandwidth	RSS-GEN 6.7	PASS
4	Hopping channel separation	RSS-247 Clause 5.1(b)	PASS
5	Number of hopping frequencies	RSS-247 Clause 5.1(d)	PASS
6	Dwell Time	RSS-247 Clause 5.1(d)	PASS
7	Spurious RF conducted emissions	RSS-247 Clause 5.5 RSS-GEN 8.10	PASS
8	Band edge	RSS-247 Clause 5.5	PASS
9	Spurious radiated emissions for transmitter	RSS-247 Clause 5.5 & RSS-GEN 6.13 RSS-GEN 8.9 RSS-GEN 8.10	PASS
10	Antenna Requirement	RSS-GEN 6.8	PASS

 CO. LTD

### 3. Measurement Uncertainty

Where relevant, the following measurement uncertainty levels have been estimated for tests performed on the Product as specified in CISPR 16-4-2. This uncertainty represents an expanded uncertainty expressed at approximately the 95% confidence level using a coverage factor of  $k=2$ .

No.	Item	Uncertainty
1	3m chamber Radiated spurious emission(30MHz-1GHz)	U=4.3dB
2	3m chamber Radiated spurious emission(1GHz-18GHz)	U=4.5dB
3	3m chamber Radiated spurious emission(18GHz-40GHz)	U=3.34dB
4	Conducted Adjacent channel power	U=1.38dB
5	Conducted output power uncertainty Above 1G	U=1.576dB
6	Conducted output power uncertainty below 1G	U=1.28dB
7	humidity uncertainty	U=5.3%
8	Temperature uncertainty	U=0.59°C

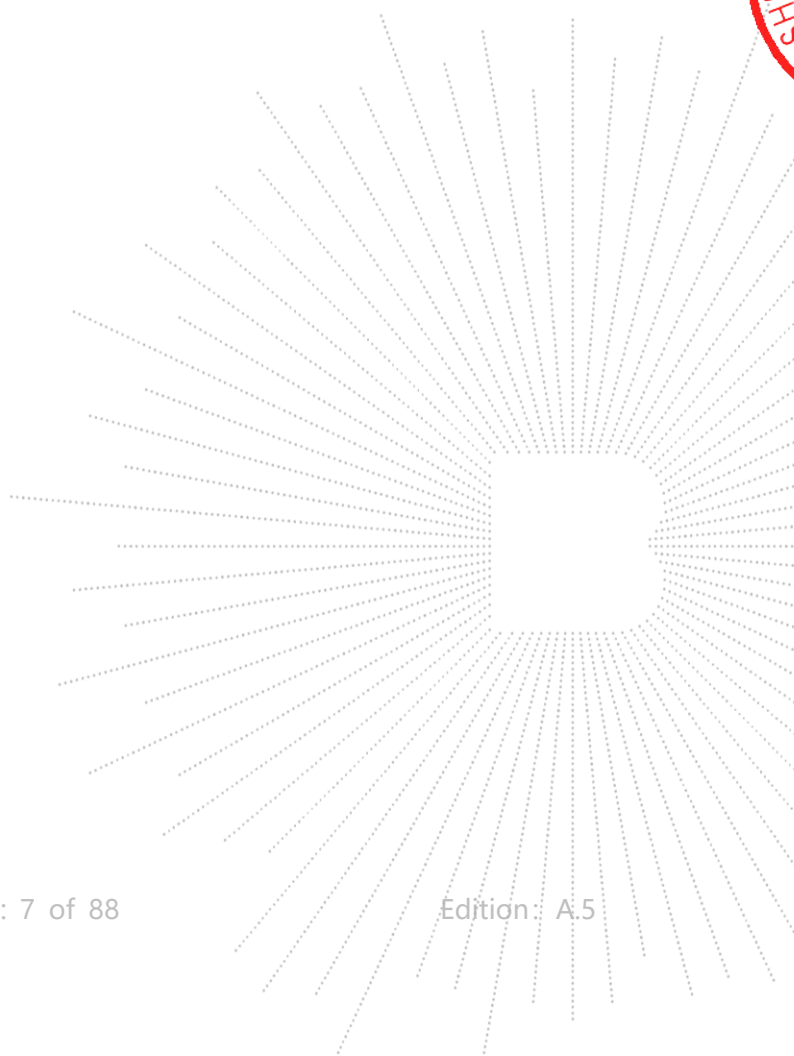
## 4. Product Information And Test Setup

### 4.1 Product Information

Model/Type Ref.:	ROCK 4 SE
Model Differences:	N/A
Bluetooth Version:	5.0
Hardware Version:	V1.52
Software Version:	4.4
Operation Frequency:	2402-2480MHz
Type of Modulation:	GFSK, $\pi/4$ DQPSK, 8DPSK
Number Of Channel	79CH
Antenna installation:	Chip antenna
Antenna Gain:	1.5 dBi
Ratings:	DC 5V from adapter

### 4.2 Test Setup Configuration

See test photographs attached in *EUT TEST SETUP PHOTOGRAPHS* for the actual connections between Product and support equipment.

Conducted Emission:

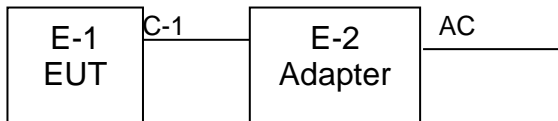

Radiated Spurious Emission

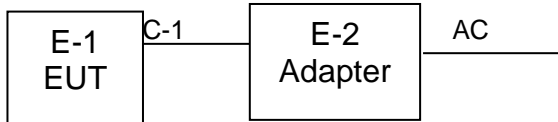

### 4.3 Support Equipment

No.	Device Type	Brand	Model	Series No.	Note
E-1	ROCK Pi 4/ROCK 4	N/A	ROCK 4 SE	N/A	EUT
E-2	Adapter	N/A	BCTC001	N/A	Auxiliary
E-3	Mouse	N/A	N/A	N/A	Auxiliary
E-4	Keyboard	N/A	N/A	N/A	Auxiliary
E-5	earphone	N/A	N/A	N/A	Auxiliary
E-6	Router	N/A	N/A	N/A	Auxiliary



Item	Shielded Type	Ferrite Core	Length	Note
C-1	NO	NO	1M	DC cable unshielded

**Notes:**

1. All the equipment/cables were placed in the worst-case configuration to maximize the emission during the test.
2. Grounding was established in accordance with the manufacturer's requirements and conditions for the intended use.

TC  
3C  
PPR  
測

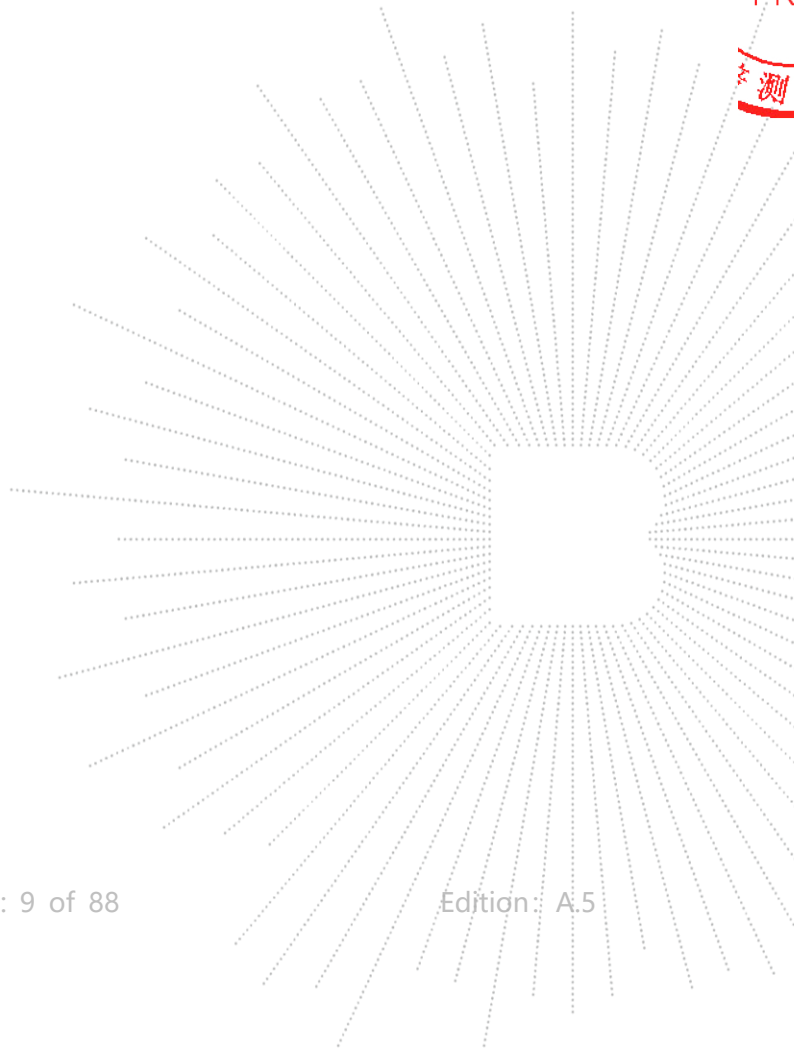

#### 4.4 Channel List

CH	Frequency (MHz)	CH	Frequency (MHz)	CH	Frequency (MHz)	CH	Frequency (MHz)
0	2402	1	2403	2	2404	3	2405
4	2406	5	2407	6	2408	7	2409
8	2410	9	2411	10	2412	11	2413
12	2414	13	2415	14	2416	15	2417
16	2418	17	2419	18	2420	19	2421
20	2422	21	2423	22	2424	23	2425
24	2426	25	2427	26	2428	27	2429
28	2430	29	2431	30	2432	31	2433
32	2434	33	2435	34	2436	35	2437
36	2438	37	2439	38	2440	39	2441
40	2442	41	2443	42	2444	43	2445
44	2446	45	2447	46	2448	47	2449
48	2450	49	2451	50	2452	51	2453
52	2454	53	2455	54	2456	55	2457
56	2458	57	2459	58	2460	59	2461
60	2462	61	2463	62	2464	63	2465
64	2466	65	2467	66	2468	67	2469
68	2470	69	2471	70	2472	71	2473
72	2474	73	2475	74	2476	75	2477
76	2478	77	2479	78	2480	79	/

#### 4.5 Test Mode

To investigate the maximum EMI emission characteristics generated from EUT, the test system was pre-scanning tested based on the consideration of following EUT operation mode or test configuration mode which possible have effect on EMI emission level. Each of these EUT operation mode(s) or test configuration mode(s) mentioned above was evaluated respectively.

Test Mode	Test mode	Low channel	Middle channel	High channel
1	Transmitting(GFSK)	2402MHz	2441MHz	2480MHz
2	Transmitting( $\pi/4$ DQPSK)	2402MHz	2441MHz	2480MHz
3	Transmitting(8DPSK)	2402MHz	2441MHz	2480MHz
4	Charging(conducted emission)			
5	Transmitting (Radiated emission)			

Note:

- (1) The measurements are performed at the highest, middle, lowest available channels.
- (2) Fully-charged battery is used during the test

#### 4.6 Table Of Parameters Of Text Software Setting

During testing channel & power controlling software provided by the customer was used to control the operating channel as well as the output power level. The RF output power selection is for the setting of RF output power expected by the customer and is going to be fixed on the firmware of the final end product power parameters

Test software Version	CMD		
Frequency	2402 MHz	2441 MHz	2480 MHz
Parameters	DEF	DEF	DEF

## 5. Test Facility And Test Instrument Used

### 5.1 Test Facility

All measurement facilities used to collect the measurement data are located at Shenzhen BCTC Testing Co., Ltd. Address: 1-2/F., Building B, Pengzhou Industrial Park, No.158, Fuyuan 1st Road, Zhancheng, Fuhai Subdistrict, Bao'an District, Shenzhen, Guangdong, China. The site and apparatus are constructed in conformance with the requirements of ANSI C63.4 and CISPR 16-1-1 other equivalent standards. FCC Test Firm Registration Number: 712850  
IC Registered No.: 23583

### 5.2 Test Instrument Used

Conducted Emissions Test					
Equipment	Manufacturer	Model#	Serial#	Last Cal.	Next Cal.
Receiver	R&S	ESR3	102075	May 24, 2022	May 23, 2023
LISN	R&S	ENV216	101375	May 24, 2022	May 23, 2023
Software	Frad	EZ-EMC	EMC-CON 3A1	\	\
Attenuator	\	10dB DC-6GHz	1650	May 24, 2022	May 23, 2023

RF Conducted Test					
Equipment	Manufacturer	Model#	Serial#	Last Cal.	Next Cal.
Power Metter	Keysight	E4419	\	May 24, 2022	May 23, 2023
Power Sensor (AV)	Keysight	E9300A	\	May 24, 2022	May 23, 2023
Signal Analyzer20kHz- z-26.5GHz	Keysight	N9020A	MY49100060	May 24, 2022	May 23, 2023
Spectrum Analyzer9kHz- 40GHz	R&S	FSP40	\	May 24, 2022	May 23, 2023

Radiated Emissions Test (966 Chamber01)					
Equipment	Manufacturer	Model#	Serial#	Last Cal.	Next Cal.
966 chamber	ChengYu	966 Room	966	Jun. 06. 2020	Jun. 05, 2023
Receiver	R&S	ESR3	102075	May 24, 2022	May 23, 2023
Receiver	R&S	ESRP	101154	May 24, 2022	May 23, 2023
Amplifier	SKET	LAPA_01G18 G-45dB	\	May 24, 2022	May 23, 2023
Amplifier	Schwarzbeck	BBV9744	9744-0037	May 24, 2022	May 23, 2023
TRILOG Broadband Antenna	Schwarzbeck	VULB9163	942	May 26, 2022	May 25, 2023
Horn Antenna	Schwarzbeck	BBHA9120D	1541	Jun. 06, 2022	Jun. 05, 2023
Horn Antenna(18G Hz-40GHz)	Schwarzbeck	BBHA9170	00822	Jun. 06, 2022	Jun. 05, 2023
Amplifier(18G Hz-40GHz)	MITEQ	TTA1840-35- HG	2034381	May 26, 2022	May 25, 2023
Loop Antenna(9KHz -30MHz)	Schwarzbeck	FMZB1519B	00014	May 26, 2022	May 25, 2023
Power Metter	Keysight	E4419	\	May 26, 2022	May 25, 2023
Power Sensor (AV)	Keysight	E9300A	\	May 26, 2022	May 25, 2023
Signal Analyzer20kH z-26.5GHz	Keysight	N9020A	MY49100060	May 26, 2022	May 25, 2023
Spectrum Analyzer9kHz- 40GHz	R&S	FSP40	\	May 26, 2022	May 25, 2023
Software	Frad	EZ-EMC	FA-03A2 RE	\	\

CO.LTD

## 6. Conducted Emissions

### 6.1 Block Diagram Of Test Setup

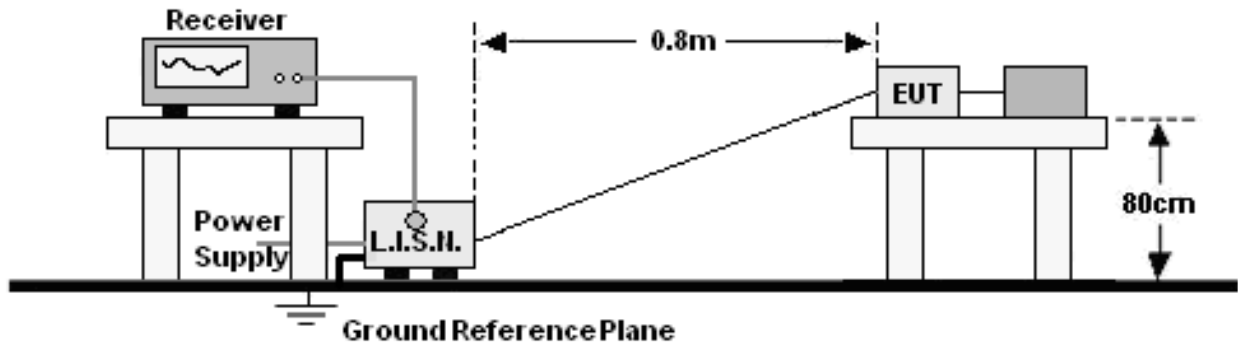

### 6.2 Limit

FREQUENCY (MHz)	Limit (dBuV)	
	Quas-peak	Average
0.15 -0.5	66 - 56 *	56 - 46 *
0.50 -5.0	56.00	46.00
5.0 -30.0	60.00	50.00

Notes:  
 1. \*Decreasing linearly with logarithm of frequency.  
 2. The lower limit shall apply at the transition frequencies.

### 6.3 Test Procedure

Receiver Parameters	Setting
Attenuation	10 dB
Start Frequency	0.15 MHz
Stop Frequency	30 MHz
IF Bandwidth	9 kHz

- The Product was placed on a nonconductive table 0.8 m above the horizontal ground reference plane, and 0.4 m from the vertical ground reference plane, and connected to the main through Line Impedance Stability Network (L.I.S.N).
- The RBW of the receiver was set at 9 kHz in 150 kHz ~ 30MHz with Peak and AVG detector in Max Hold mode. Run the receiver's pre-scan to record the maximum disturbance generated from Product in all power lines in the full band.
- For each frequency whose maximum record was higher or close to limit, measure its QP and AVG values and record.

### 6.4 EUT Operating Conditions

The EUT was configured for testing in a typical fashion (as a customer would normally use it). The EUT has been programmed to continuously transmit during test. This operating condition was tested and used to collect the included data.

## 6.5 Test Result

Temperature:	26 °C	Relative Humidity:	54%
Pressure:	101KPa	Phase :	L
Test Mode:	Mode 1	Test Voltage :	AC120V/60Hz

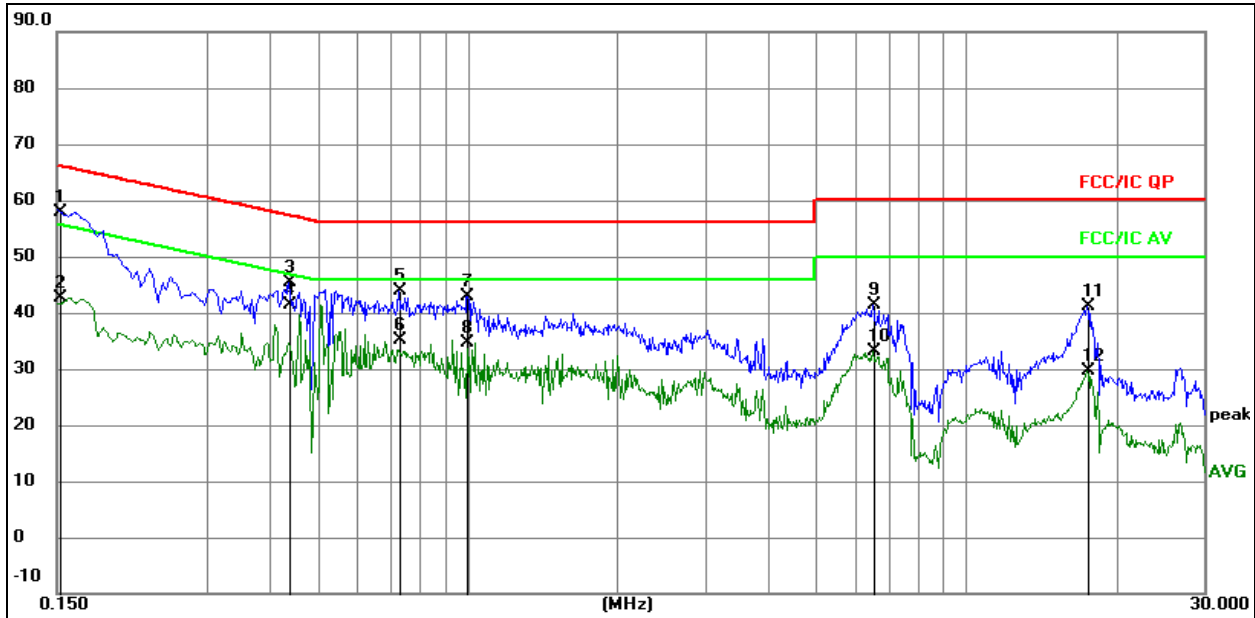

Remark:

1. All readings are Quasi-Peak and Average values.
2. Factor = Insertion Loss + Cable Loss.
3. Measurement=Reading Level+ Correct Factor
4. Over=Measurement-Limit

No.	Mk.	Freq. MHz	Reading Level	Correct Factor dB	Measure- ment dBuV	Limit dBuV	Over dB	Detector
1		0.1524	38.29	19.68	57.97	65.87	-7.90	QP
2		0.1524	23.04	19.68	42.72	55.87	-13.15	AVG
3		0.4380	25.52	19.74	45.26	57.10	-11.84	QP
4	*	0.4380	21.57	19.74	41.31	47.10	-5.79	AVG
5		0.7304	24.10	19.74	43.84	56.00	-12.16	QP
6		0.7304	15.42	19.74	35.16	46.00	-10.84	AVG
7		0.9960	23.18	19.76	42.94	56.00	-13.06	QP
8		0.9960	14.90	19.76	34.66	46.00	-11.34	AVG
9		6.5130	21.13	20.17	41.30	60.00	-18.70	QP
10		6.5130	12.96	20.17	33.13	50.00	-16.87	AVG
11		17.5470	20.82	20.40	41.22	60.00	-18.78	QP
12		17.5470	9.26	20.40	29.66	50.00	-20.34	AVG

Temperature:	26 °C	Relative Humidity:	54%
Pressure:	101KPa	Phase :	N
Test Mode:	Mode 1	Test Voltage :	AC120V/60Hz

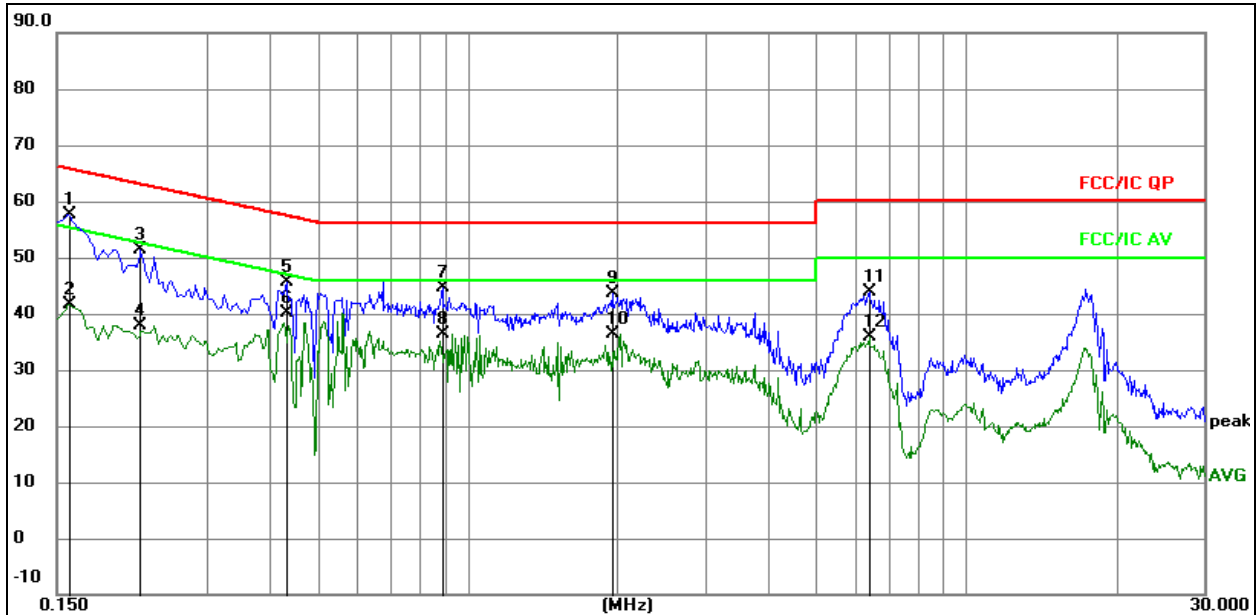
**Remark:**

1. All readings are Quasi-Peak and Average values.
2. Factor = Insertion Loss + Cable Loss.
3. Measurement=Reading Level+ Correct Factor
4. Over=Measurement-Limit

No.	Mk.	Freq. MHz	Reading Level	Correct Factor dB	Measure- ment dBuV	Limit dBuV	Over dB	Detector
1		0.1582	38.02	19.69	57.71	65.56	-7.85	QP
2		0.1582	21.90	19.69	41.59	55.56	-13.97	AVG
3		0.2208	31.55	19.79	51.34	62.79	-11.45	QP
4		0.2208	18.06	19.79	37.85	52.79	-14.94	AVG
5		0.4328	25.84	19.74	45.58	57.20	-11.62	QP
6	*	0.4328	20.51	19.74	40.25	47.20	-6.95	AVG
7		0.8897	24.92	19.75	44.67	56.00	-11.33	QP
8		0.8897	16.64	19.75	36.39	46.00	-9.61	AVG
9		1.9489	23.79	19.87	43.66	56.00	-12.34	QP
10		1.9489	16.52	19.87	36.39	46.00	-9.61	AVG
11		6.3859	23.71	20.16	43.87	60.00	-16.13	QP
12		6.3859	15.67	20.16	35.83	50.00	-14.17	AVG

## 7. Radiated Emissions

### 7.1 Block Diagram Of Test Setup

(A) Radiated Emission Test-Up Frequency Below 30MHz

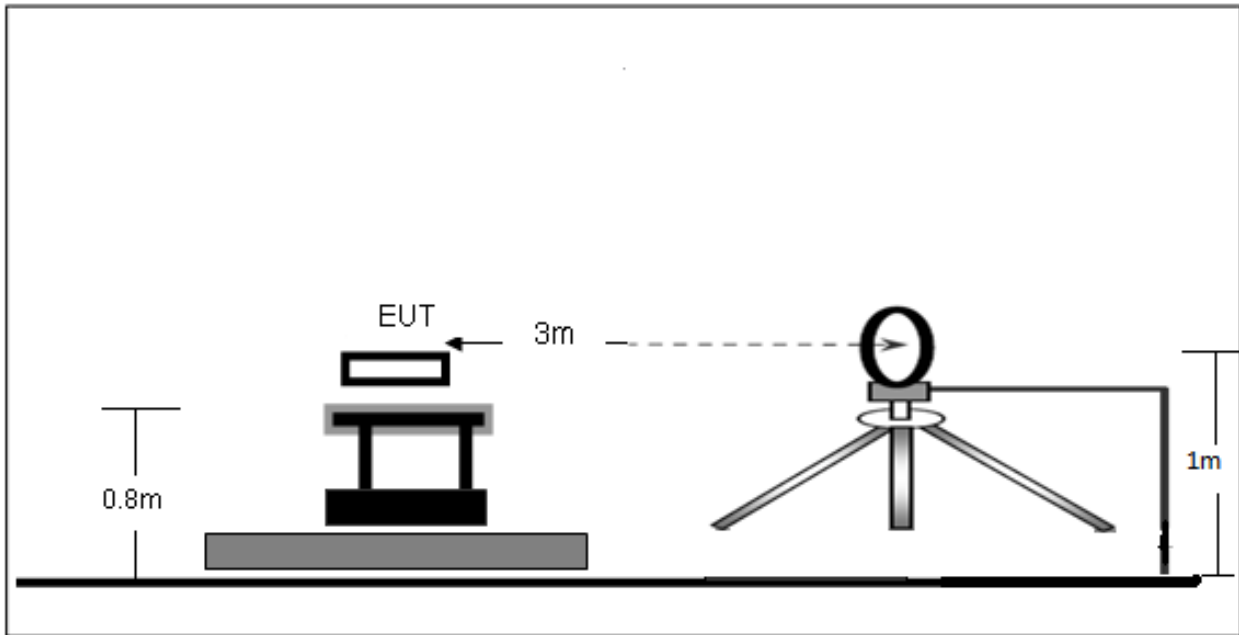

(B) Radiated Emission Test-Up Frequency 30MHz~1GHz

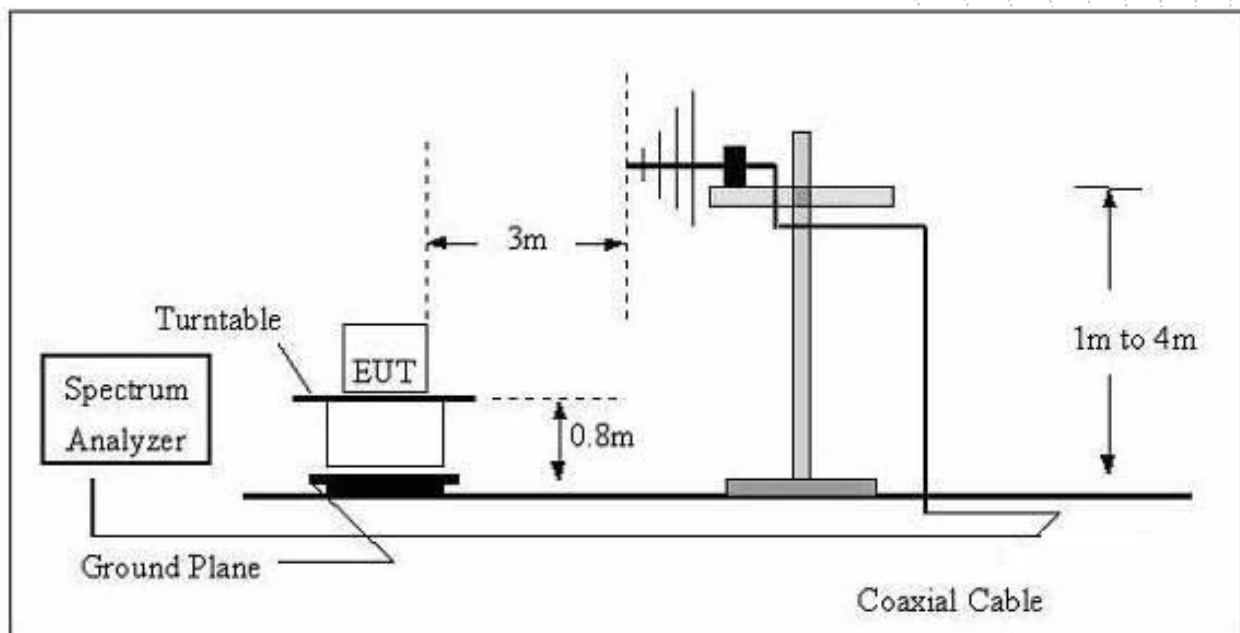



## (C) Radiated Emission Test-Up Frequency Above 1GHz



## 7.2 Limit

20dBc in any 100 kHz bandwidth outside the operating frequency band. In case the emission fall within the restricted band specified on RSS-GEN 8.9, then the RSS-GEN 8.9 limit in the table below has to be followed.

Frequency (MHz)	Field Strength uV/m	Distance (m)	Field Strength Limit at 3m Distance	
			uV/m	dBuV/m
0.009 ~ 0.490	2400/F(kHz)	300	10000 * 2400/F(kHz)	$20\log^{(2400/F(kHz))} + 80$
0.490 ~ 1.705	24000/F(kHz)	30	100 * 24000/F(kHz)	$20\log^{(24000/F(kHz))} + 40$
1.705 ~ 30	30	30	100 * 30	$20\log^{(30)} + 40$
30 ~ 88	100	3	100	$20\log^{(100)}$
88 ~ 216	150	3	150	$20\log^{(150)}$
216 ~ 960	200	3	200	$20\log^{(200)}$
Above 960	500	3	500	$20\log^{(500)}$

## LIMITS OF RADIATED EMISSION MEASUREMENT (Above 1000MHz)

FREQUENCY (MHz)	Limit (dBuV/m) (at 3M)	
	PEAK	AVERAGE
Above 1000	74	54

## Notes:

- (1)The limit for radiated test was performed according to FCC PART 15C.
- (2)The tighter limit applies at the band edges.
- (3) Emission level (dBuV/m)=20log Emission level (uV/m).

**FREQUENCY RANGE OF RADIATED MEASUREMENT (For unintentional radiators)**

Highest frequency generated or Upper frequency of measurement used in the device or on which the device operates or tunes (MHz)	Range (MHz)
Below 1.705	30
1.705 – 108	1000
108 – 500	2000
500 – 1000	5000
Above 1000	5 <sup>th</sup> harmonic of the highest frequency or 40 GHz, whichever is lower

**7.3 Test Procedure**

Receiver Parameter	Setting
Attenuation	Auto
9kHz~150kHz	RBW 200Hz for QP
150kHz~30MHz	RBW 9kHz for QP
30MHz~1000MHz	RBW 120kHz for QP

Spectrum Parameter	Setting
1-25GHz	RBW 1 MHz /VBW 1 MHz for Peak, RBW 1 MHz / VBW 10Hz for Average

Below 1GHz test procedure as below:

- a. The EUT was placed on the top of a rotating table 0.8 meters above the ground at a 3 meter semi-anechoic chamber. The table was rotated 360 degrees to determine the position of the highest radiation.
- b. The EUT was set 3 meters away from the interference-receiving antenna, which was mounted on the top of a variable-height antenna tower.
- c. The antenna height is varied from one meter to four meters above the ground to determine the maximum value of the field strength. Both horizontal and vertical polarizations of the antenna are set to make the measurement.
- d. For each suspected emission, the EUT was arranged to its worst case and then the antenna was tuned to heights from 1 meter to 4 meters (for the test frequency of below 30MHz, the antenna was tuned to heights 1 meter) and the rotatable table was turned from 0 degrees to 360 degrees to find the maximum reading.
- e. The test-receiver system was set to Peak Detect Function and Specified Bandwidth with Maximum Hold Mode.
- f. If the emission level of the EUT in peak mode was 10dB lower than the limit specified, then testing could be stopped and the peak values of the EUT would be reported. Otherwise the emissions that did not have 10dB margin would be re-tested one by one using peak, quasi-peak or average method as specified and then reported in a data sheet.

Above 1GHz test procedure as below:

- g. Different between above is the test site, change from Semi- Anechoic Chamber to fully Anechoic Chamber and change form table 0.8 metre to 1.5 metre( Above 18GHz the distance is 1 meter and table is 1.5 metre).
- h. Test the EUT in the lowest channel ,the middle channel ,the Highest channel.

Note:

Both horizontal and vertical antenna polarities were tested and performed pretest to three orthogonal axis. The worst case emissions were reported.

Above 1GHz test procedure as below:

- a. The EUT was placed on the top of a rotating table 1.5 meters above the ground at a 3 meter camber. The table was rotated 360 degrees to determine the position of the highest radiation.
- b. The EUT was set 3 meters away from the interference-receiving antenna, which was mounted on the top of a variable-height antenna tower.
- c. The antenna height is varied from one meter to four meters above the ground to determine the maximum value of the field strength. Both horizontal and vertical polarizations of the antenna are set to make the measurement.
- d. For each suspected emission, the EUT was arranged to its worst case and then the antenna was tuned to heights from 1 meter to 4 meters and the rota table was turned from 0 degrees to 360 degrees to find the maximum reading.
- e. The test-receiver system was set to Peak Detect Function and Specified Bandwidth with Maximum Hold Mode.
- f. If the emission level of the EUT in peak mode was 10dB lower than the limit specified, then testing could be stopped and the peak values of the EUT would be reported. Otherwise the emissions that did not have 10dB margin would be re-tested one by one using peak, quasi-peak or average method as specified and then reported in a data sheet.
- g. Test the EUT in the lowest channel, the Highest channel.

Note:

Both horizontal and vertical antenna polarities were tested and performed pretest to three orthogonal axis. The worst case emissions were reported.

## 7.4 EUT Operating Conditions

The EUT was configured for testing in a typical fashion (as a customer would normally use it). The EUT has been programmed to continuously transmit during test. This operating condition was tested and used to collect the included data.

## 7.5 Test Result

Below 30MHz

Temperature:	26°C	Relative Humidity:	24%
Pressure:	101KPa	Test Voltage:	AC120V/60Hz
Test Mode:	Mode 1	Polarization :	--

Freq.	Reading	Limit	Margin	State
(MHz)	(dBuV/m)	(dBuV/m)	(dB)	P/F
--	--	--	--	PASS
--	--	--	--	PASS

Note:

The amplitude of spurious emissions which are attenuated by more than 20dB below the permissible value has no need to be reported.

Distance extrapolation factor =  $40 \log(\text{specific distance/test distance})(\text{dB})$ ;

Limit line = specific limits(dBuv) + distance extrapolation factor.



Between 30MHz – 1GHz

Temperature:	26 °C	Relative Humidity:	54%
Pressure:	101KPa	Phase :	Horizontal
Test Mode:	Mode 1	Test Voltage:	AC120V/60Hz

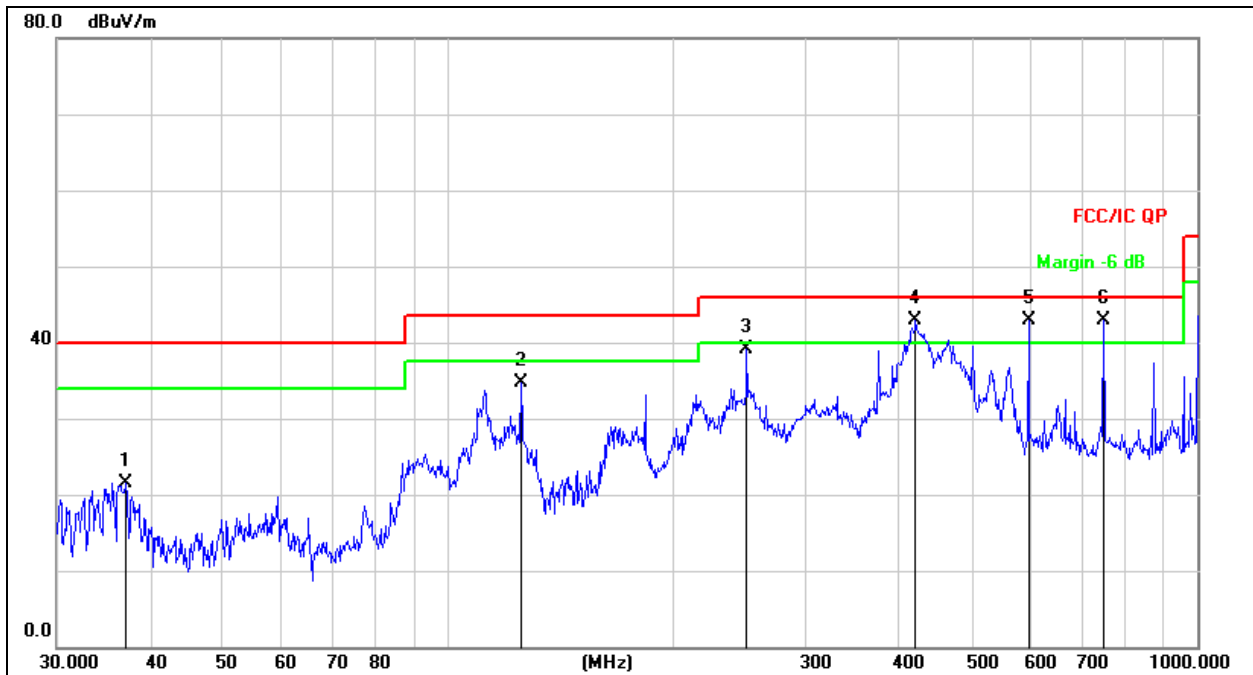
**Remark:**

1. Factor = Antenna Factor + Cable Loss – Pre-amplifier.
2. Measurement=Reading Level+ Correct Factor
3. Over=Measurement-Limit

No.	Mk.	Freq. MHz	Reading Level dBuV	Correct Factor dB	Measure- ment dBuV/m	Limit dB/m	Over dB	Detector
1		37.1550	38.76	-17.19	21.57	40.00	-18.43	QP
2		125.0066	54.13	-19.41	34.72	43.50	-8.78	QP
3		250.3012	54.93	-15.82	39.11	46.00	-6.89	QP
4	!	420.5803	54.77	-11.91	42.86	46.00	-3.14	QP
5	*	595.1329	51.48	-8.51	42.97	46.00	-3.03	QP
6	!	750.1083	49.23	-6.37	42.86	46.00	-3.14	QP

Temperature:	26 °C	Relative Humidity:	54%
Pressure:	101KPa	Phase :	Vertical
Test Mode:	Mode 1	Test Voltage:	AC120V/60Hz

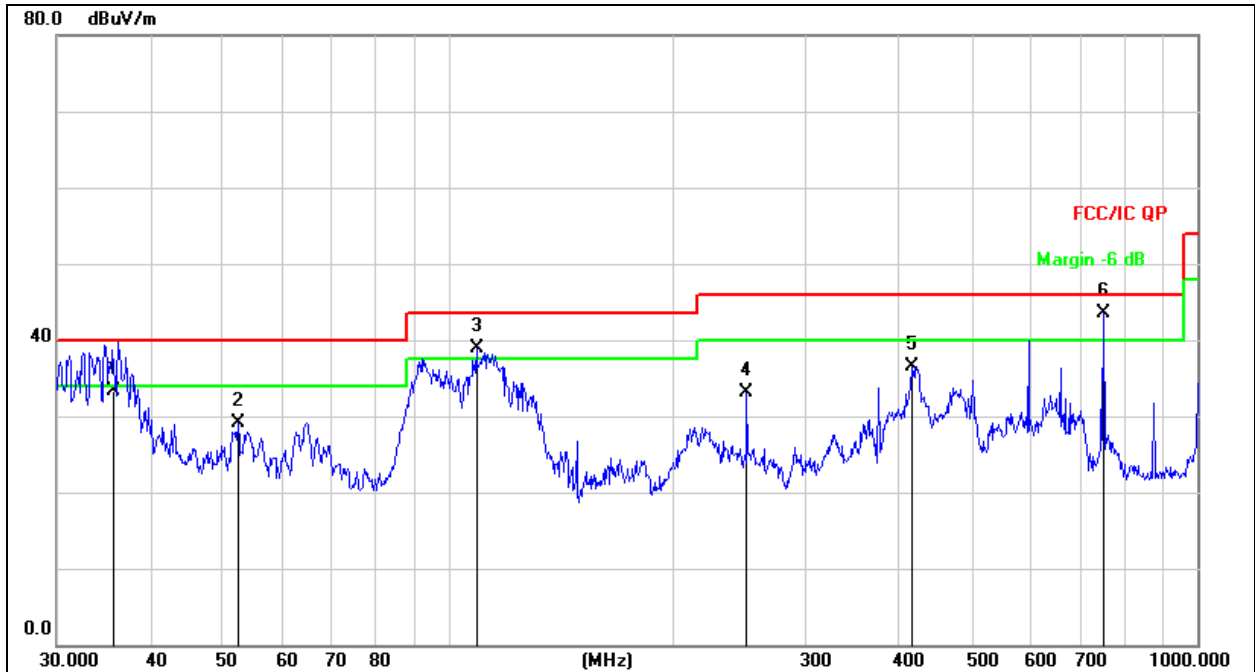
**Remark:**

1. Factor = Antenna Factor + Cable Loss – Pre-amplifier.
2. Measurement=Reading Level+ Correct Factor
3. Over=Measurement-Limit

No.	Mk.	Freq. MHz	Reading Level dBuV	Correct Factor dB	Measure- ment dBuV/m	Limit dB/m	Over dB	Detector
1		35.8535	50.79	-17.41	33.38	40.00	-6.62	QP
2		52.3912	45.13	-15.95	29.18	40.00	-10.82	QP
3	!	109.0286	57.17	-18.35	38.82	43.50	-4.68	QP
4		250.3012	48.89	-15.82	33.07	46.00	-12.93	QP
5		416.1791	48.46	-11.98	36.48	46.00	-9.52	QP
6	*	750.1083	49.95	-6.37	43.58	46.00	-2.42	QP

BCTC  
 3C  
 PPR  
 检测

Between 1GHz – 25GHz

Polar (H/V)	Frequency	Reading Level	Correct Factor	Measure- ment	Limits	Over	Detector Type
	(MHz)	(dBuV/m)	(dB)	(dBuV/m)	(dBuV/ m)	(dB)	
GFSK Low channel							
V	4804.00	53.81	-0.43	53.38	74.00	-20.62	PK
V	4804.00	42.98	-0.43	42.55	54.00	-11.45	AV
V	7206.00	45.80	8.31	54.11	74.00	-19.89	PK
V	7206.00	35.08	8.31	43.39	54.00	-10.61	AV
H	4804.00	52.57	-0.43	52.14	74.00	-21.86	PK
H	4804.00	41.68	-0.43	41.25	54.00	-12.75	AV
H	7206.00	44.25	8.31	52.56	74.00	-21.44	PK
H	7206.00	36.43	8.31	44.74	54.00	-9.26	AV
GFSK Middle channel							
V	4882.00	51.85	-0.38	51.47	74.00	-22.53	PK
V	4882.00	43.36	-0.38	42.98	54.00	-11.02	AV
V	7323.00	41.33	8.83	50.16	74.00	-23.84	PK
V	7323.00	32.15	8.83	40.98	54.00	-13.02	AV
H	4882.00	50.24	-0.38	49.86	74.00	-24.14	PK
H	4882.00	39.30	-0.38	38.92	54.00	-15.08	AV
H	7323.00	40.28	8.83	49.11	74.00	-24.89	PK
H	7323.00	32.92	8.83	41.75	54.00	-12.25	AV
GFSK High channel							
V	4960.00	54.76	-0.32	54.44	74.00	-19.56	PK
V	4960.00	44.35	-0.32	44.03	54.00	-9.97	AV
V	7440.00	46.63	9.35	55.98	74.00	-18.02	PK
V	7440.00	36.24	9.35	45.59	54.00	-8.41	AV
H	4960.00	53.65	-0.32	53.33	74.00	-20.67	PK
H	4960.00	43.55	-0.32	43.23	54.00	-10.77	AV
H	7440.00	45.59	9.35	54.94	74.00	-19.06	PK
H	7440.00	38.40	9.35	47.75	54.00	-6.25	AV

**Remark:**

1. Emission Level = Meter Reading + Factor,  
 Factor = Antenna Factor + Cable Loss – Pre-amplifier.  
 Over = Emission Level - Limit

2. If peak below the average limit, the average emission was no test.

3. In restricted bands of operation, The spurious emissions below the permissible value more than 20dB

4. The amplitude of spurious emissions which are attenuated by more than 20dB below the permissible value has no need to be reported.

TEST  
 TO  
 OVER  
 検査

Polar (H/V)	Frequency	Reading Level	Correct Factor	Measurement	Limits	Over	Detector Type
	(MHz)	(dBuV/m)	(dB)	(dBuV/m)	(dBuV/m)	(dB)	
$\pi$ /4DQPSK Low channel							
V	4804.00	53.22	-0.43	52.79	74.00	-21.21	PK
V	4804.00	43.54	-0.43	43.11	54.00	-10.89	AV
V	7206.00	43.95	8.31	52.26	74.00	-21.74	PK
V	7206.00	33.77	8.31	42.08	54.00	-11.92	AV
H	4804.00	50.30	-0.43	49.87	74.00	-24.13	PK
H	4804.00	39.56	-0.43	39.13	54.00	-14.87	AV
H	7206.00	41.84	8.31	50.15	74.00	-23.85	PK
H	7206.00	33.89	8.31	42.20	54.00	-11.80	AV
$\pi$ /4DQPSK Middle channel							
V	4882.00	51.19	-0.38	50.81	74.00	-23.19	PK
V	4882.00	42.73	-0.38	42.35	54.00	-11.65	AV
V	7323.00	42.74	8.83	51.57	74.00	-22.43	PK
V	7323.00	34.62	8.83	43.45	54.00	-10.55	AV
H	4882.00	46.43	-0.38	46.05	74.00	-27.95	PK
H	4882.00	35.66	-0.38	35.28	54.00	-18.72	AV
H	7323.00	40.48	8.83	49.31	74.00	-24.69	PK
H	7323.00	31.75	8.83	40.58	54.00	-13.42	AV
$\pi$ /4DQPSK High channel							
V	4960.00	54.13	-0.32	53.81	74.00	-20.19	PK
V	4960.00	45.81	-0.32	45.49	54.00	-8.51	AV
V	7440.00	45.22	9.35	54.57	74.00	-19.43	PK
V	7440.00	35.19	9.35	44.54	54.00	-9.46	AV
H	4960.00	51.32	-0.32	51.00	74.00	-23.00	PK
H	4960.00	42.17	-0.32	41.85	54.00	-12.15	AV
H	7440.00	42.58	9.35	51.93	74.00	-22.07	PK
H	7440.00	34.16	9.35	43.51	54.00	-10.49	AV

**Remark:**

1. Emission Level = Meter Reading + Factor,  
Factor = Antenna Factor + Cable Loss – Pre-amplifier.  
Over = Emission Level - Limit
2. If peak below the average limit, the average emission was no test.
3. In restricted bands of operation, The spurious emissions below the permissible value more than 20dB
4. The amplitude of spurious emissions which are attenuated by more than 20dB below the permissible value has no need to be reported.

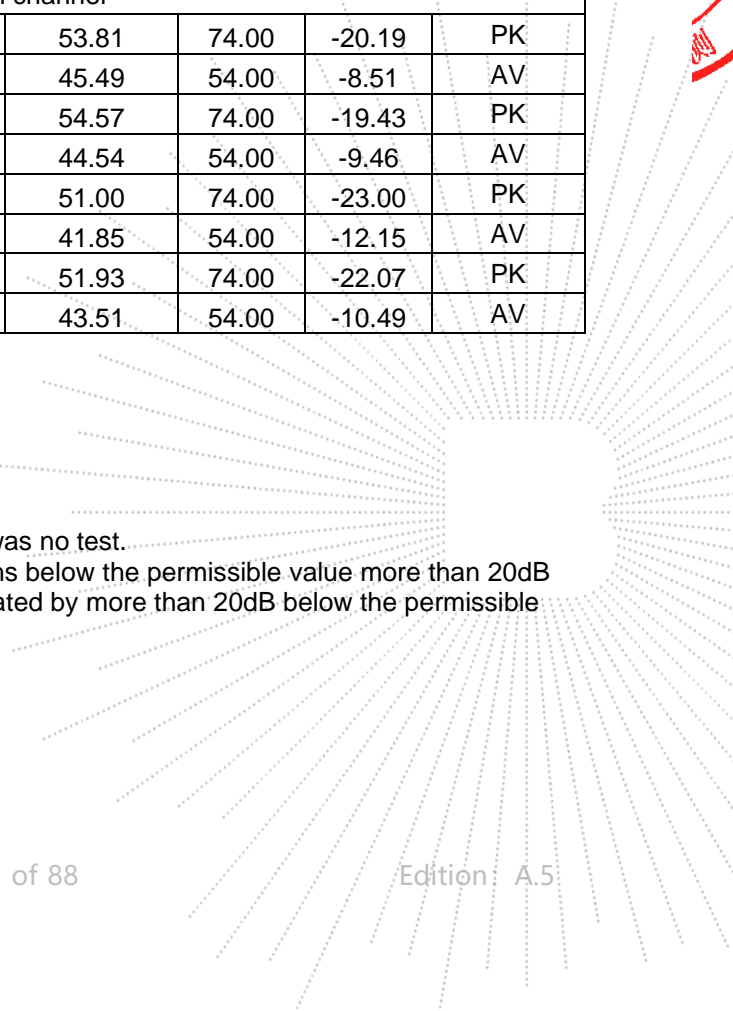

Polar (H/V)	Frequency	Reading Level	Correct Factor	Measurement	Limits	Over	Detector Type
	(MHz)	(dBuV/m)	(dB)	(dBuV/m)	(dBuV/m)	(dB)	
8DPSK Low channel							
V	4804.00	53.27	-0.43	52.84	74.00	-21.16	PK
V	4804.00	43.18	-0.43	42.75	54.00	-11.25	AV
V	7206.00	44.41	8.31	52.72	74.00	-21.28	PK
V	7206.00	33.55	8.31	41.86	54.00	-12.14	AV
H	4804.00	48.72	-0.43	48.29	74.00	-25.71	PK
H	4804.00	38.02	-0.43	37.59	54.00	-16.41	AV
H	7206.00	42.87	8.31	51.18	74.00	-22.82	PK
H	7206.00	35.58	8.31	43.89	54.00	-10.11	AV
8DPSK Middle channel							
V	4882.00	51.79	-0.38	51.41	74.00	-22.59	PK
V	4882.00	42.96	-0.38	42.58	54.00	-11.42	AV
V	7323.00	42.54	8.83	51.37	74.00	-22.63	PK
V	7323.00	33.99	8.83	42.82	54.00	-11.18	AV
H	4882.00	48.87	-0.38	48.49	74.00	-25.51	PK
H	4882.00	39.46	-0.38	39.08	54.00	-14.92	AV
H	7323.00	40.09	8.83	48.92	74.00	-25.08	PK
H	7323.00	31.21	8.83	40.04	54.00	-13.96	AV
8DPSK High channel							
V	4960.00	54.66	-0.32	54.34	74.00	-19.66	PK
V	4960.00	44.88	-0.32	44.56	54.00	-9.44	AV
V	7440.00	46.20	9.35	55.55	74.00	-18.45	PK
V	7440.00	35.27	9.35	44.62	54.00	-9.38	AV
H	4960.00	52.21	-0.32	51.89	74.00	-22.11	PK
H	4960.00	42.97	-0.32	42.65	54.00	-11.35	AV
H	7440.00	43.45	9.35	52.80	74.00	-21.20	PK
H	7440.00	36.28	9.35	45.63	54.00	-8.37	AV

**Remark:**

1. Emission Level = Meter Reading + Factor,  
Factor = Antenna Factor + Cable Loss – Pre-amplifier.  
Over= Emission Level - Limit
2. If peak below the average limit, the average emission was no test.
3. In restricted bands of operation, The spurious emissions below the permissible value more than 20dB
4. The amplitude of spurious emissions which are attenuated by more than 20dB below the permissible value has no need to be reported.



## 8. Radiated Band Emission Measurement And Restricted Bands Of Operation

### 8.1 Block Diagram Of Test Setup

Radiated Emission Test-Up Frequency Above 1GHz

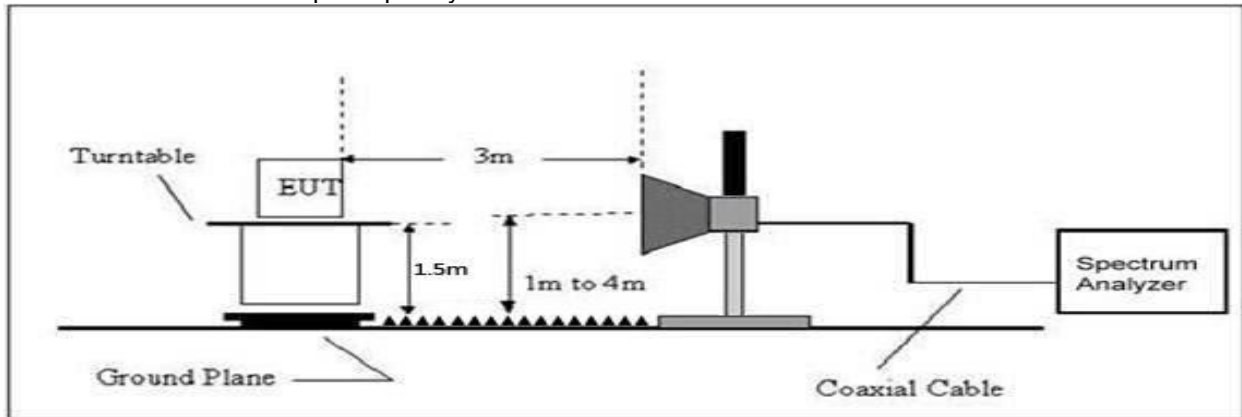

### 8.2 Limit

RSS-GEN, RSS-247 5.5

Table 7 – Restricted frequency bands\*

MHz	MHz	GHz
0.090 - 0.110	149.9 - 150.05	9.0 - 9.2
0.495 - 0.505	156.52475 - 156.52525	9.3 - 9.5
2.1735 - 2.1905	156.7 - 156.9	10.6 - 12.7
3.020 - 3.026	162.0125 - 167.17	13.25 - 13.4
4.125 - 4.128	167.72 - 173.2	14.47 - 14.5
4.17725 - 4.17775	240 - 285	15.35 - 16.2
4.20725 - 4.20775	322 - 335.4	17.7 - 21.4
5.677 - 5.683	399.9 - 410	22.01 - 23.12
6.215 - 6.218	608 - 614	23.6 - 24.0
6.26775 - 6.26825	960 - 1427	31.2 - 31.8
6.31175 - 6.31225	1435 - 1626.5	36.43 - 36.5
8.291 - 8.294	1645.5 - 1646.5	Above 38.6
8.362 - 8.366	1660 - 1710	
8.37625 - 8.38675	1718.8 - 1722.2	
8.41425 - 8.41475	2200 - 2300	
12.29 - 12.293	2310 - 2390	
12.51975 - 12.52025	2483.5 - 2500	
12.57675 - 12.57725	2655 - 2900	
13.36 - 13.41	3260 - 3267	
16.42 - 16.423	3332 - 3339	
16.69475 - 16.69525	3345.8 - 3358	
16.80425 - 16.80475	3500 - 4400	
25.5 - 25.67	4500 - 5150	
37.5 - 38.25	5350 - 5460	
73 - 74.6	7250 - 7750	
74.8 - 75.2	8025 - 8500	
108 - 138	--	

\* Certain frequency bands listed in table 7 and in bands above 38.6 GHz are designated for licence-exempt applications. These frequency bands and the requirements that apply to related devices are set out in the 200 and 300 series of RSSs.

## LIMITS OF RADIATED EMISSION MEASUREMENT (Above 1000MHz)

FREQUENCY (MHz)	Limit (dBuV/m) (at 3M)	
	PEAK	AVERAGE
Above 1000	74	54

## Notes:

- (1)The limit for radiated test was performed according to RSS-GEN.
- (2)The tighter limit applies at the band edges.
- (3)Emission level (dBuV/m)=20log Emission level (uV/m).

### 8.3 Test Procedure

Receiver Parameter	Setting
Attenuation	Auto
Start Frequency	2300MHz
Stop Frequency	2520
RB / VB (emission in restricted band)	1 MHz / 1 MHz for Peak, 1 MHz / 10Hz for Average

Above 1GHz test procedure as below:

- a. The EUT was placed on the top of a rotating table 1.5 meters above the ground at a 3 meter camber. The table was rotated 360 degrees to determine the position of the highest radiation.
- b. The EUT was set 3 meters away from the interference-receiving antenna, which was mounted on the top of a variable-height antenna tower.
- c. The antenna height is varied from one meter to four meters above the ground to determine the maximum value of the field strength. Both horizontal and vertical polarizations of the antenna are set to make the measurement.
- d. For each suspected emission, the EUT was arranged to its worst case and then the antenna was tuned to heights from 1 meter to 4 meters and the rota table was turned from 0 degrees to 360 degrees to find the maximum reading.
- e. The test-receiver system was set to Peak Detect Function and Specified Bandwidth with Maximum Hold Mode.
- f. If the emission level of the EUT in peak mode was 10dB lower than the limit specified, then testing could be stopped and the peak values of the EUT would be reported. Otherwise the emissions that did not have 10dB margin would be re-tested one by one using peak, quasi-peak or average method as specified and then reported in a data sheet.
- g. Test the EUT in the lowest channel, the Highest channel.

## Note:

Both horizontal and vertical antenna polarities were tested and performed pretest to three orthogonal axis. The worst case emissions were reported.

### 8.4 EUT Operating Conditions

The EUT was configured for testing in a typical fashion (as a customer would normally use it). The EUT has been programmed to continuously transmit during test. This operating condition was tested and used to collect the included data.

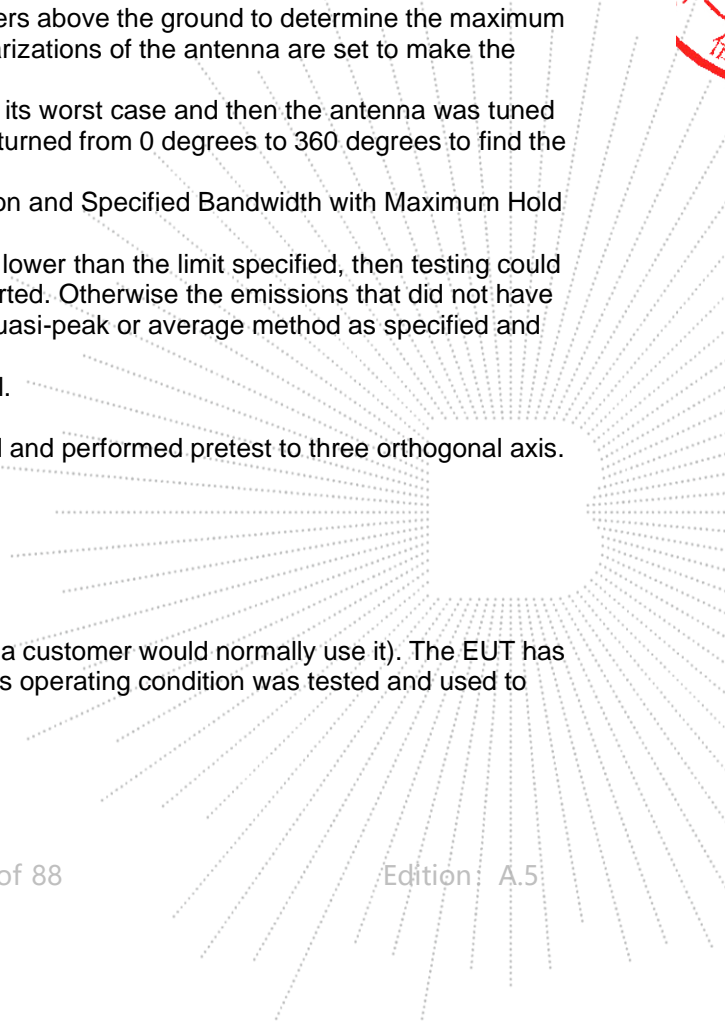

## 8.5 Test Result

	Polar (H/V)	Frequency (MHz)	Reading Level (dBuV/m)	Correct Factor (dB)	Measurement (dBuV/m)	Limits (dBuV/m)		Result	
					PK	PK	AV		
GFSK	Low Channel 2402MHz								
	H	2390.00	54.21	-6.70	47.51	74.00	54.00	PASS	
	H	2400.00	58.07	-6.71	51.36	74.00	54.00	PASS	
	V	2390.00	53.96	-6.70	47.26	74.00	54.00	PASS	
	V	2400.00	57.32	-6.71	50.61	74.00	54.00	PASS	
	High Channel 2480MHz								
	H	2483.50	56.98	-6.79	50.19	74.00	54.00	PASS	
	H	2500.00	52.05	-6.81	45.24	74.00	54.00	PASS	
	V	2483.50	56.23	-6.79	49.44	74.00	54.00	PASS	
	V	2500.00	51.72	-6.81	44.91	74.00	54.00	PASS	
	$\pi/4$ QPSK	Low Channel 2402MHz							
		H	2390.00	53.11	-6.70	46.41	74.00	54.00	PASS
H		2400.00	57.94	-6.71	51.23	74.00	54.00	PASS	
V		2390.00	53.37	-6.70	46.67	74.00	54.00	PASS	
V		2400.00	58.11	-6.71	51.40	74.00	54.00	PASS	
High Channel 2480MHz									
H		2483.50	57.38	-6.79	50.59	2483.50	56.60	-6.79	
H		2500.00	50.21	-6.81	43.40	2500.00	51.76	-6.81	
V		2483.50	56.69	-6.79	49.90	2483.50	56.25	-6.79	
V		2500.00	51.87	-6.81	45.06	2500.00	52.41	-6.81	
8DPSK		Low Channel 2402MHz							
		H	2390.00	54.29	-6.70	47.59	74.00	54.00	PASS
	H	2400.00	58.10	-6.71	51.39	74.00	54.00	PASS	
	V	2390.00	55.09	-6.70	48.39	74.00	54.00	PASS	
	V	2400.00	58.31	-6.71	51.60	74.00	54.00	PASS	
	High Channel 2480MHz								
	H	2483.50	56.95	-6.79	50.16	74.00	54.00	PASS	
	H	2500.00	51.85	-6.81	45.04	74.00	54.00	PASS	
	V	2483.50	58.10	-6.79	51.31	74.00	54.00	PASS	
	V	2500.00	53.47	-6.81	46.66	74.00	54.00	PASS	
	<b>Remark:</b> 1. Emission Level = Meter Reading + Factor, Factor = Antenna Factor + Cable Loss – Pre-amplifier. Over= Emission Level – Limit 2. If the PK measured levels comply with average limit, then the average level were deemed to comply with average limit. 3 In restricted bands of operation, The spurious emissions below the permissible value more than 20dB 4. The amplitude of spurious emissions which are attenuated by more than 20dB below the permissible value has no need to be reported.								

 BCTC  
 3C  
 PPR  
 检测

## 9. Conducted Emission

### 9.1 Block Diagram Of Test Setup



### 9.2 Limit

In any 100 kHz bandwidth outside the frequency band in which the spread spectrum or digitally modulated device is operating, the RF power that is produced shall be at least 20 dB below that in the 100 kHz bandwidth within the band that contains the highest level of the desired power, based on either an RF conducted or a radiated measurement, provided that the transmitter demonstrates compliance with the peak conducted power limits. If the transmitter complies with the conducted power limits based on the use of root-mean-square averaging over a time interval, as permitted under section RSS-247 5.4(d), the attenuation required shall be 30 dB instead of 20 dB. Attenuation below the general field strength limits specified in RSS-Gen is not required.

### 9.3 Test Procedure

1. Remove the antenna from the EUT and then connect a low RF cable from the antenna port to the spectrum;
2. Set the spectrum analyzer:  
Below 30MHz:  
RBW = 100kHz, VBW = 300kHz, Sweep = auto  
Detector function = peak, Trace = max hold  
Above 30MHz:  
RBW = 100KHz, VBW = 300KHz, Sweep = auto  
Detector function = peak, Trace = max hold

## 9.4 Test Result

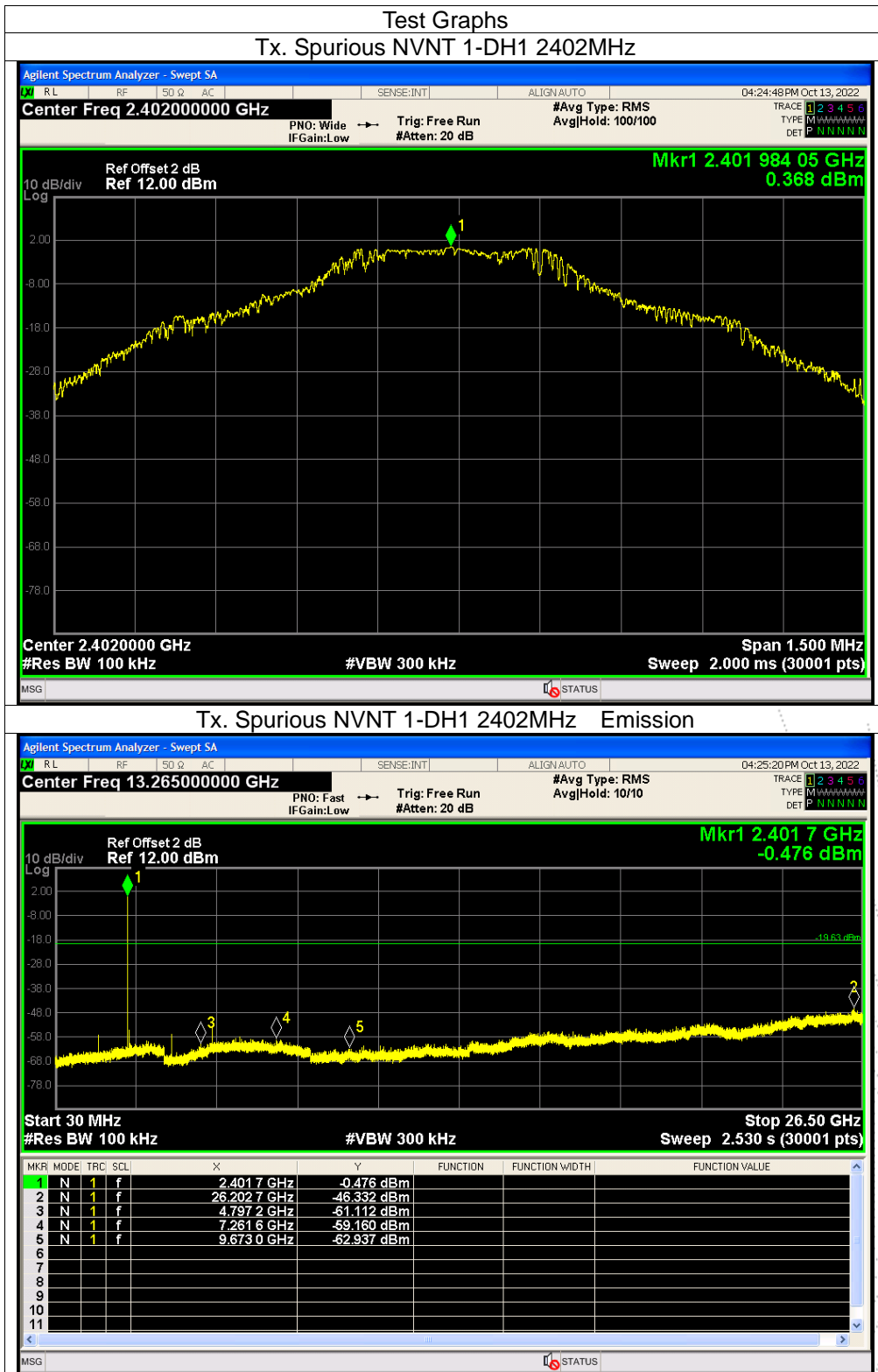

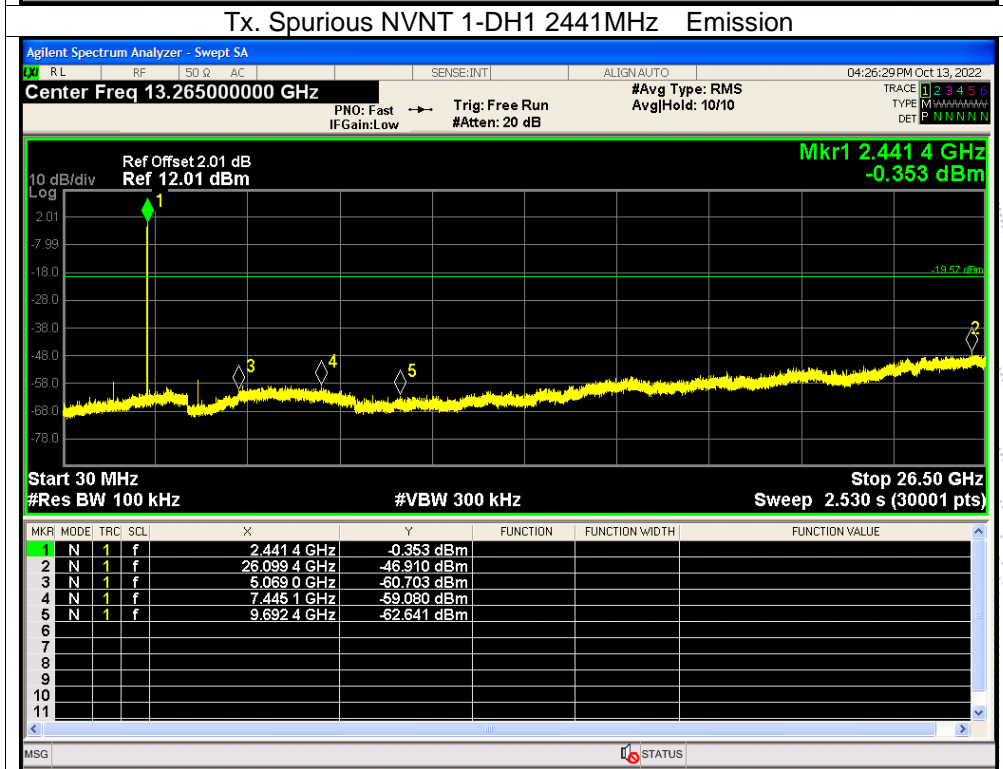
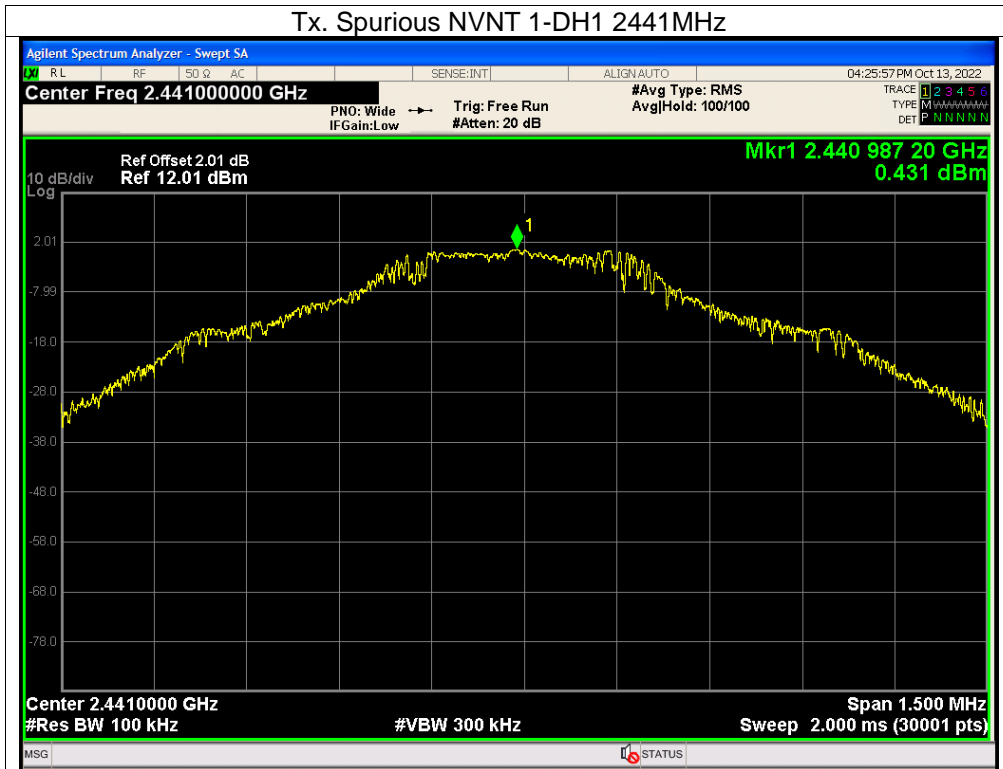

GO.LTD

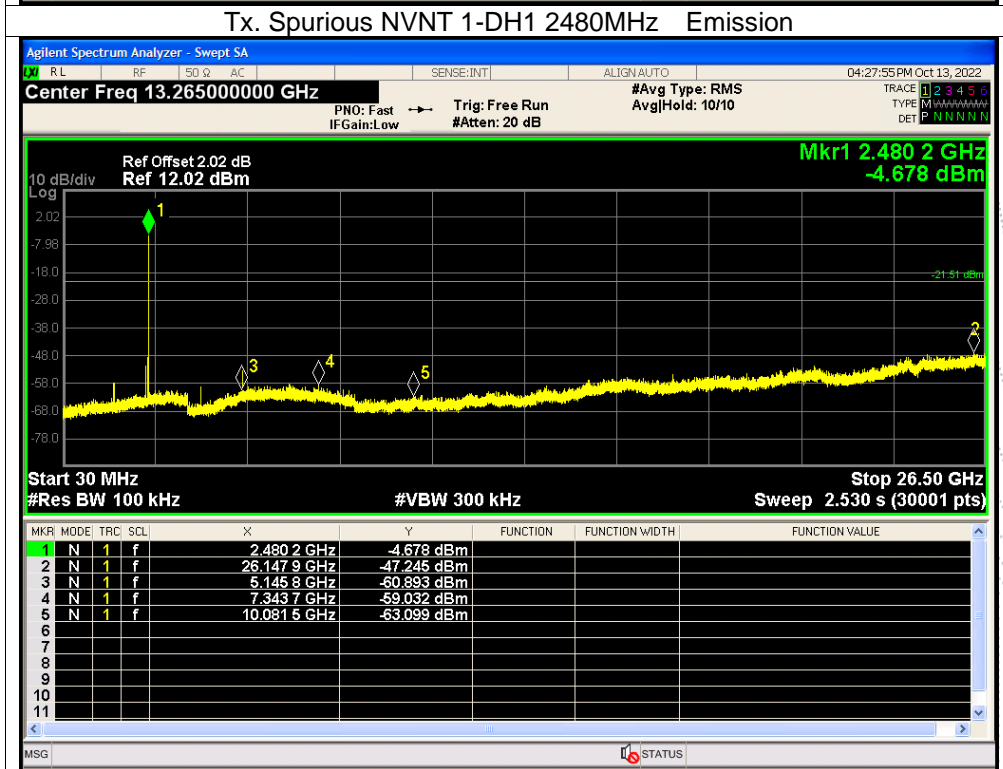
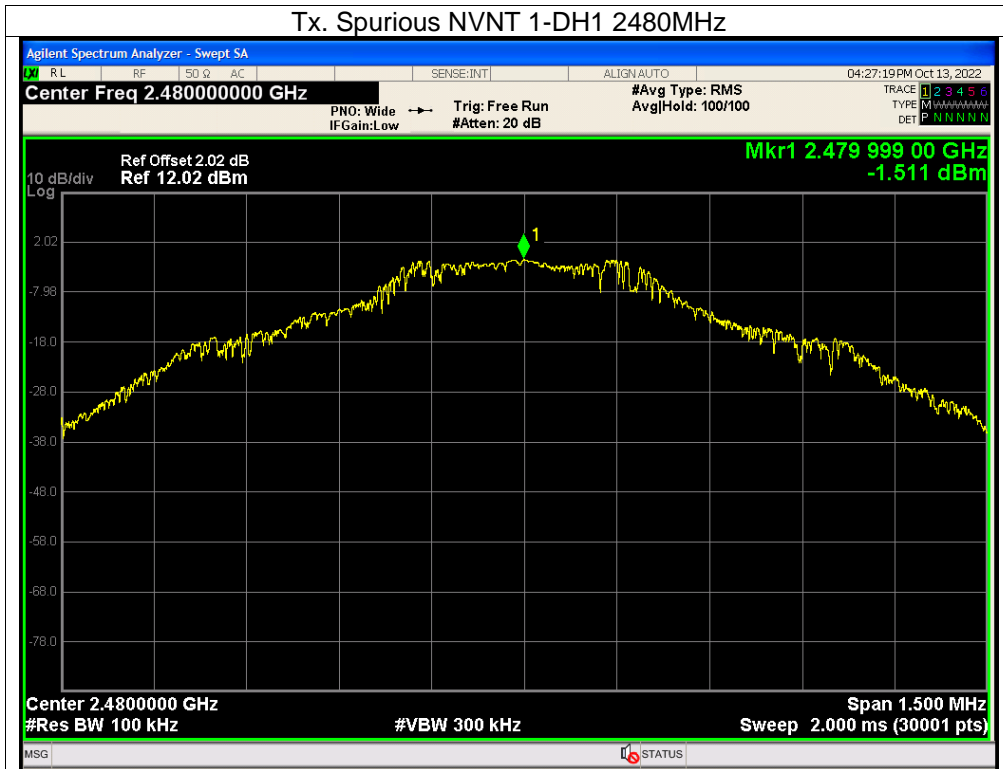

SHENZHEN

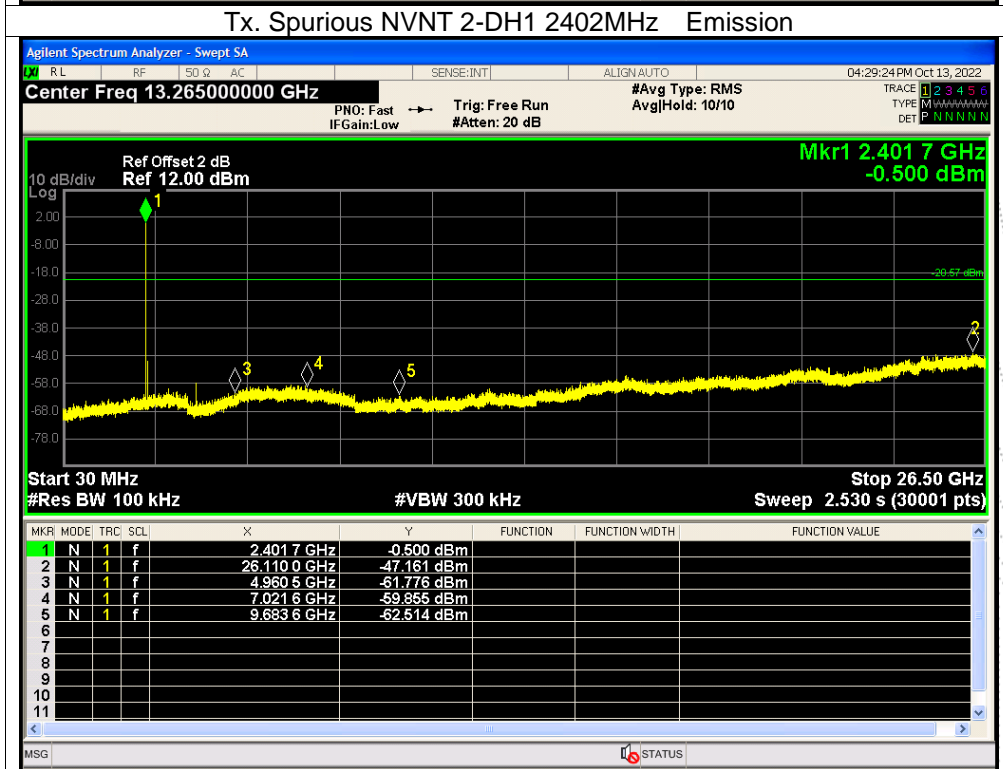
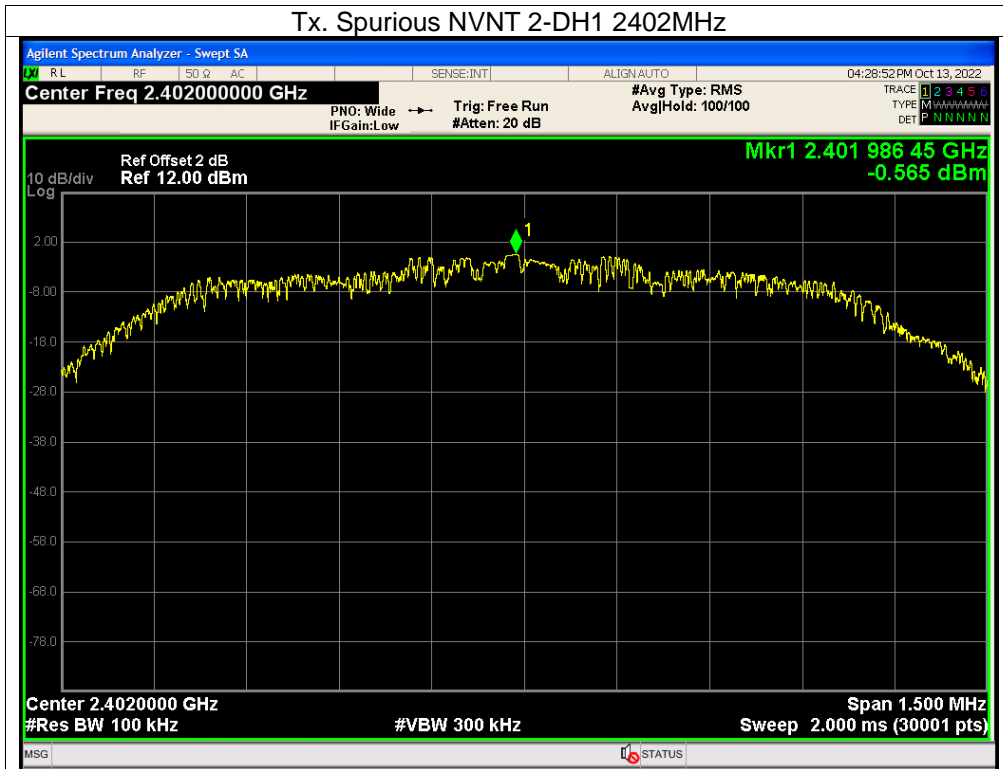



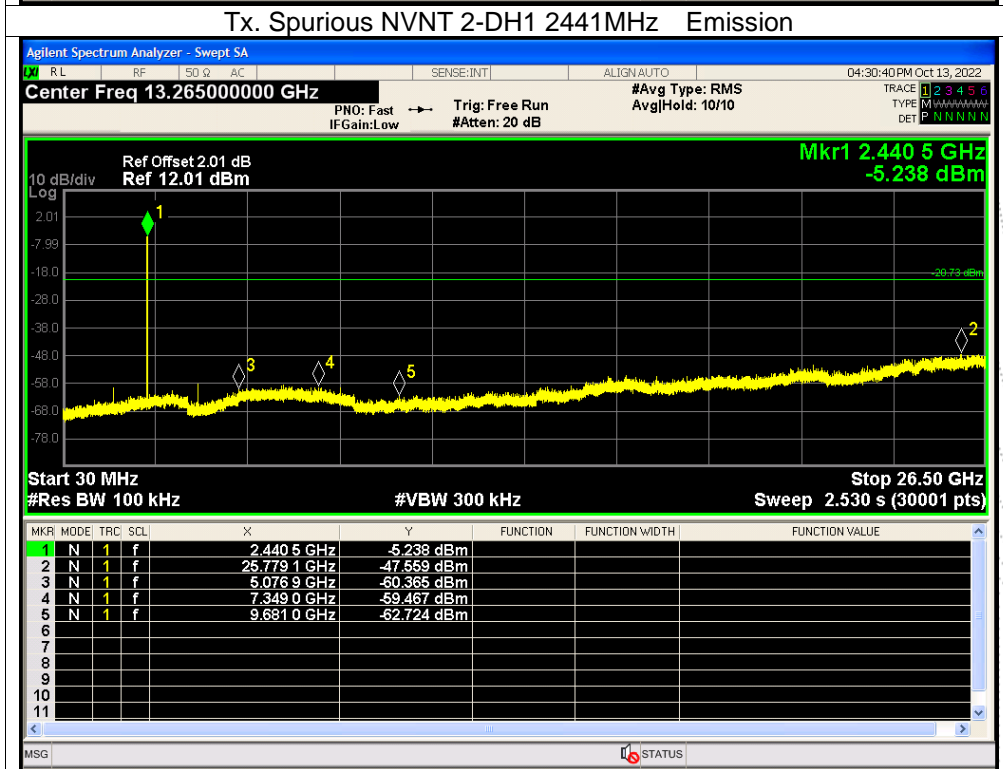
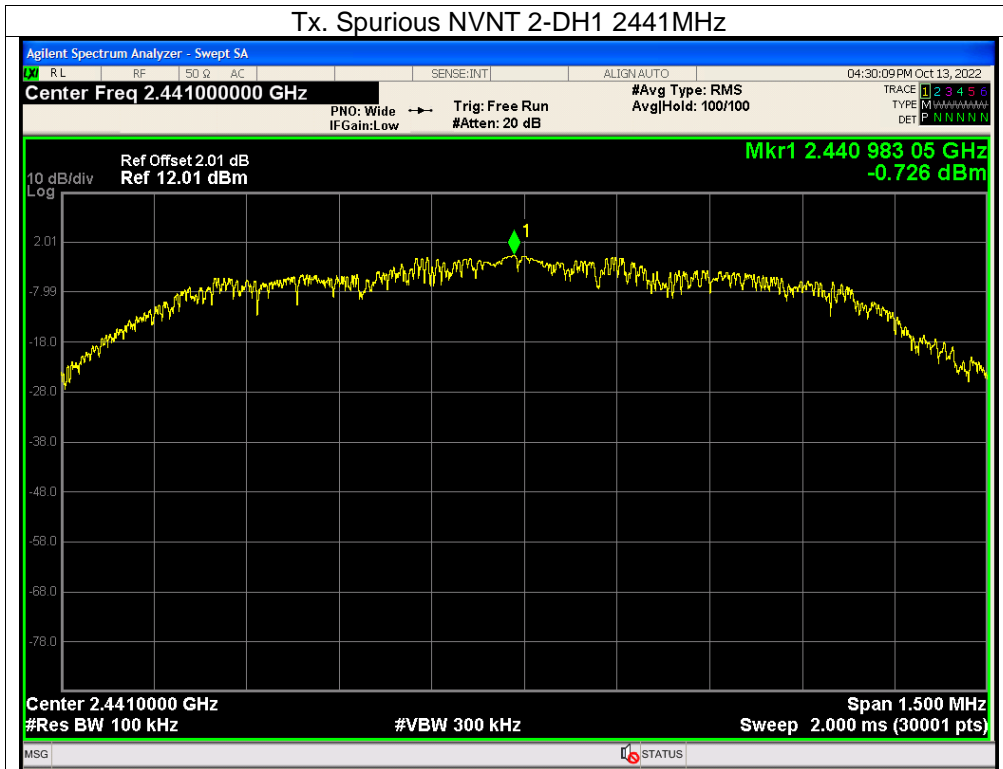

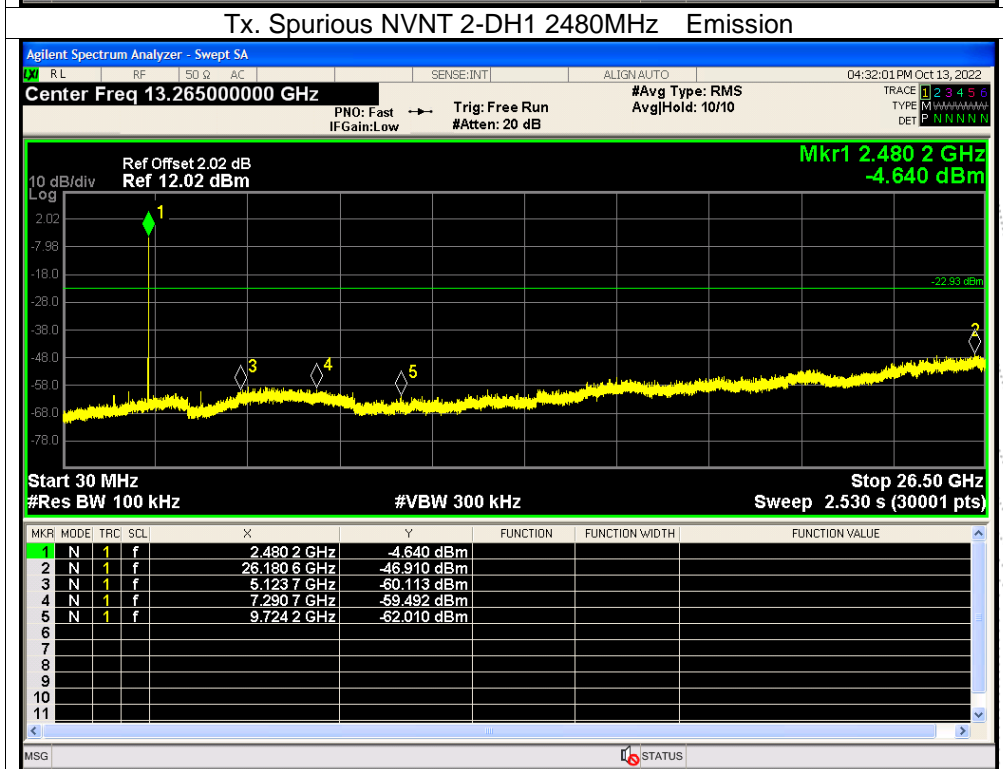
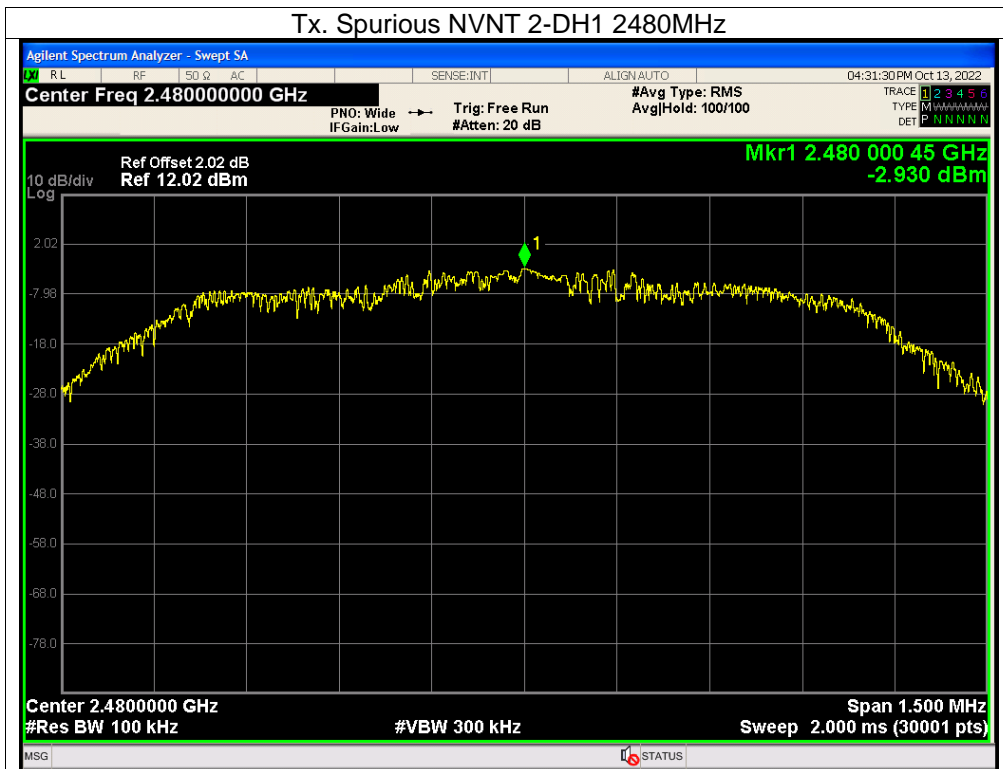

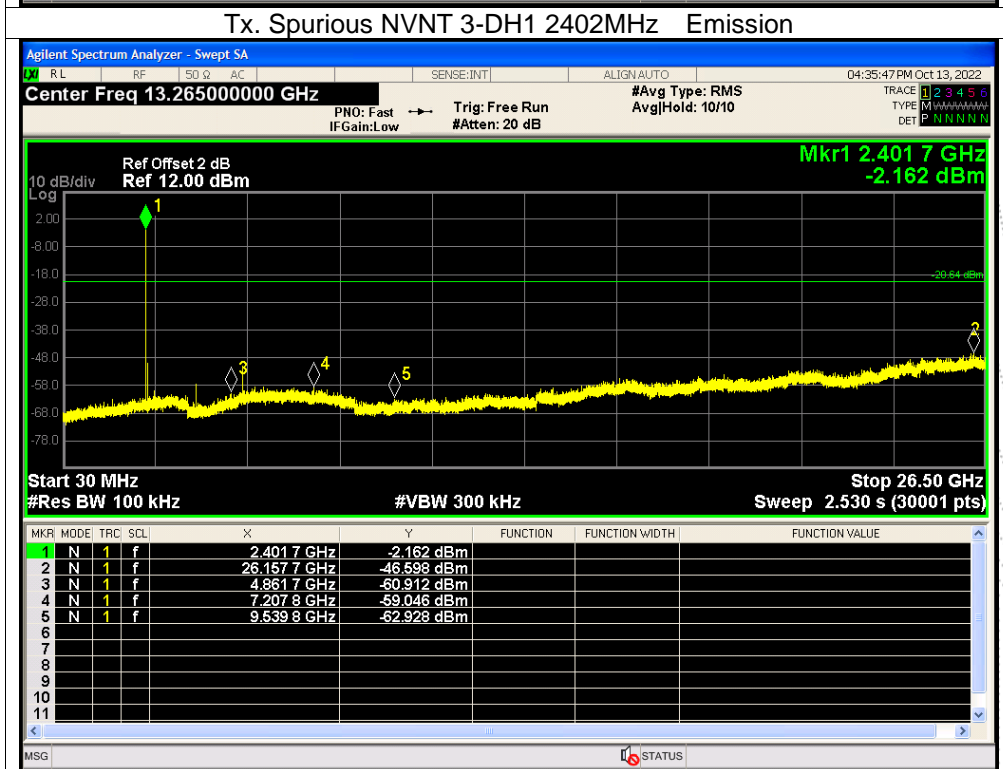
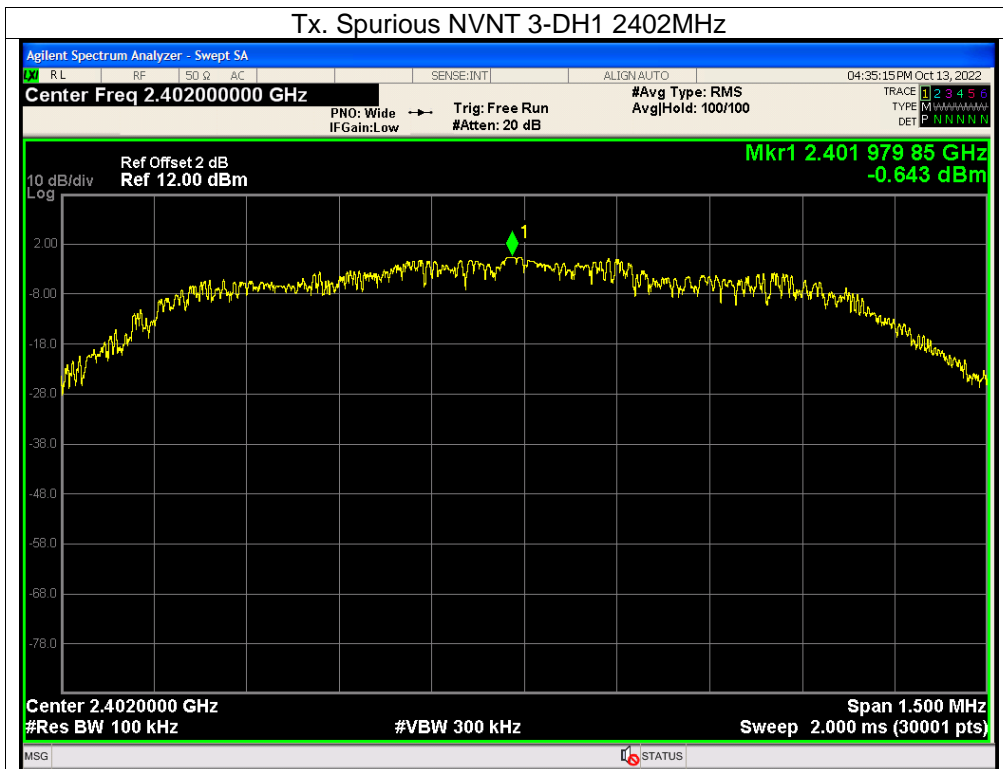

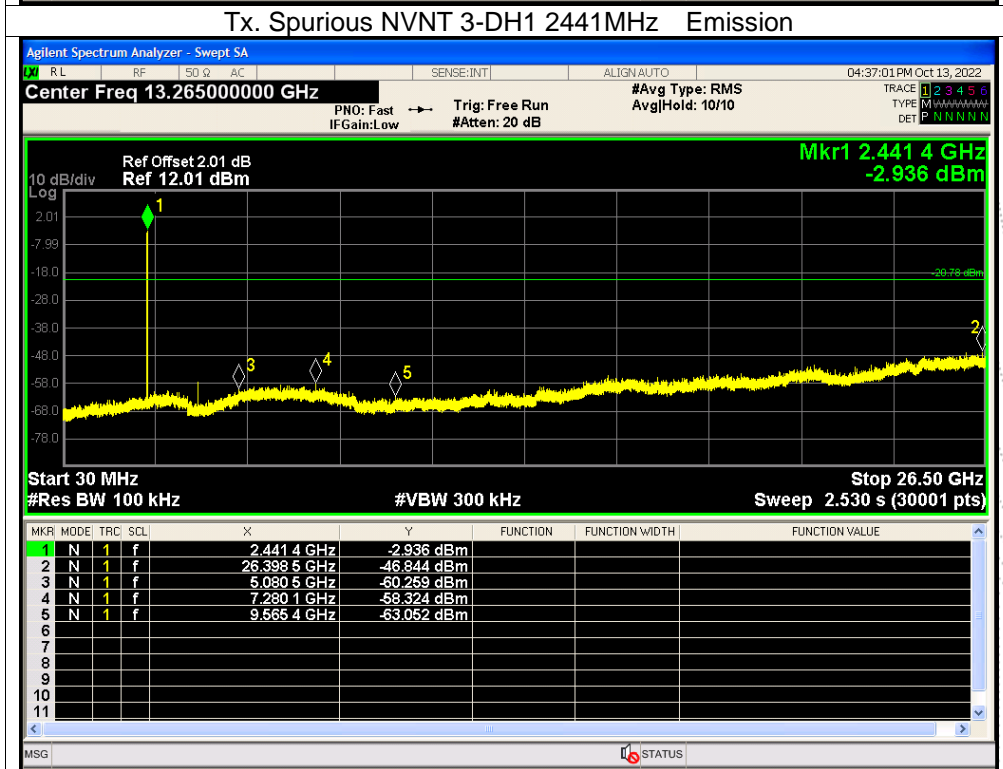
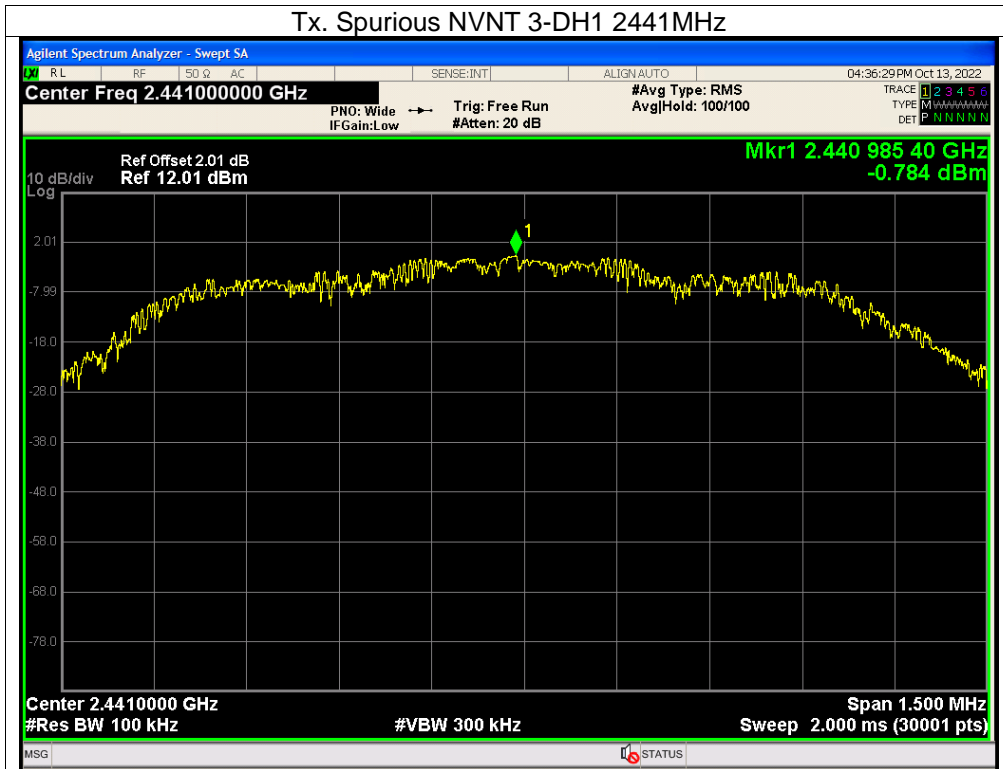

CO. LTD

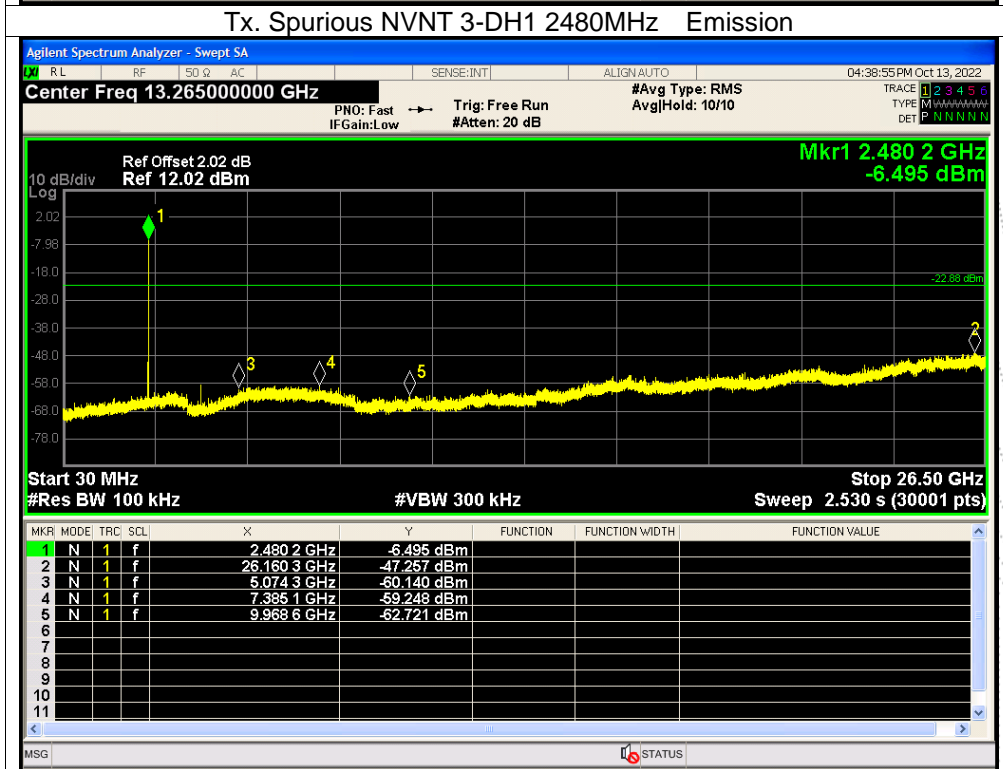
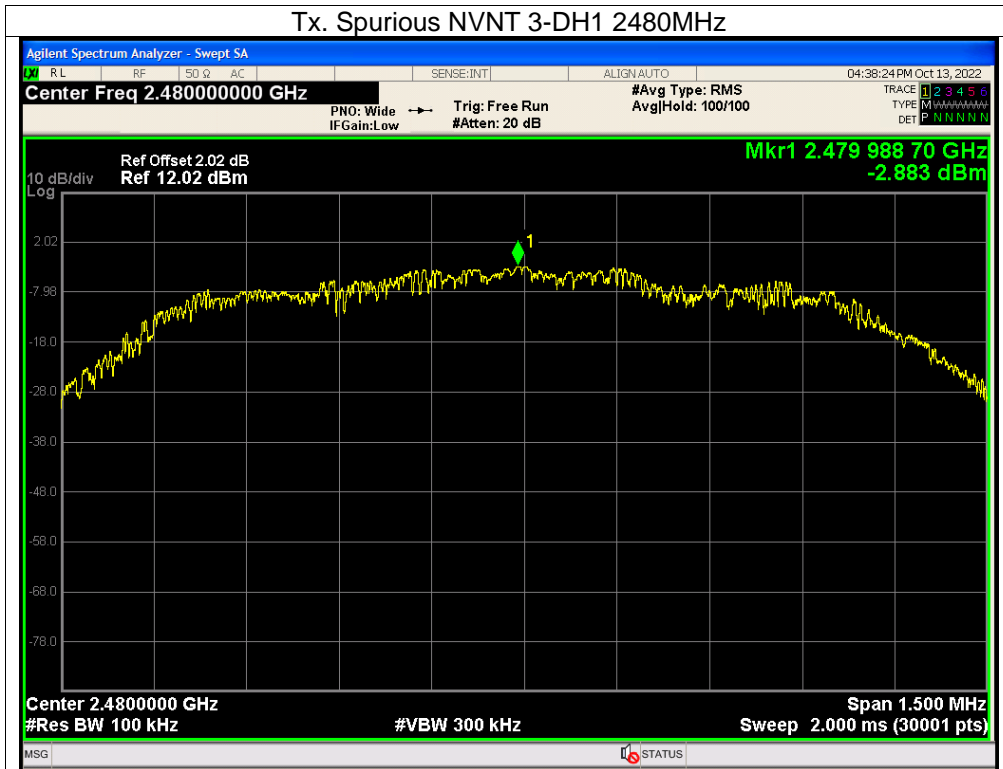

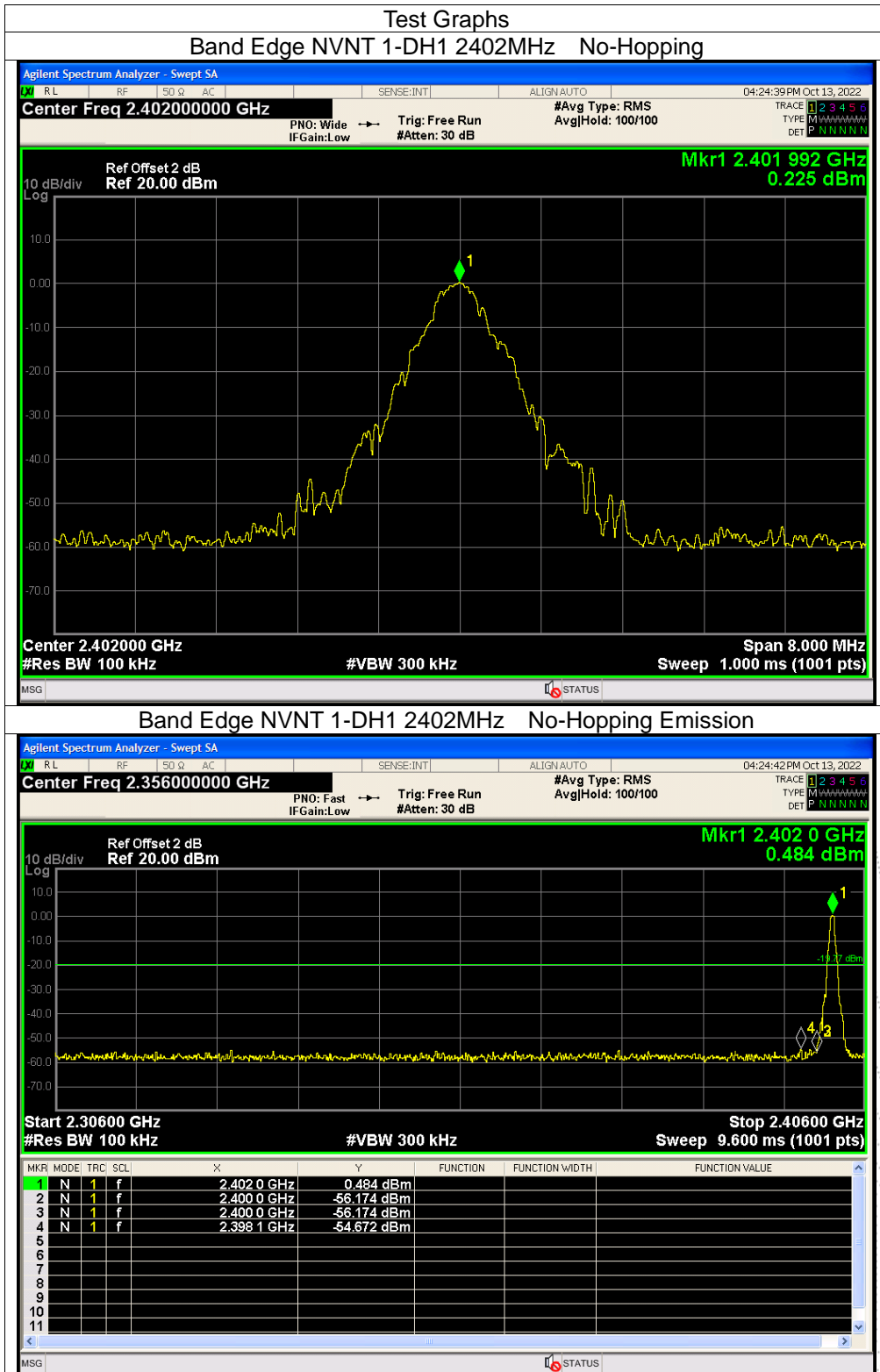

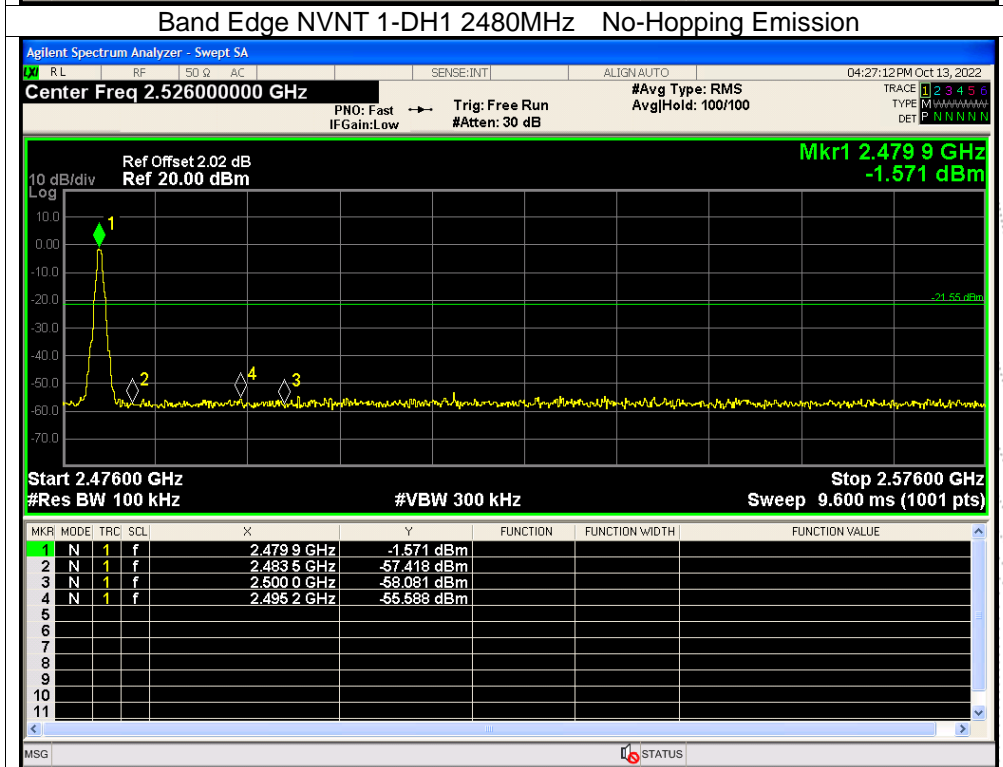
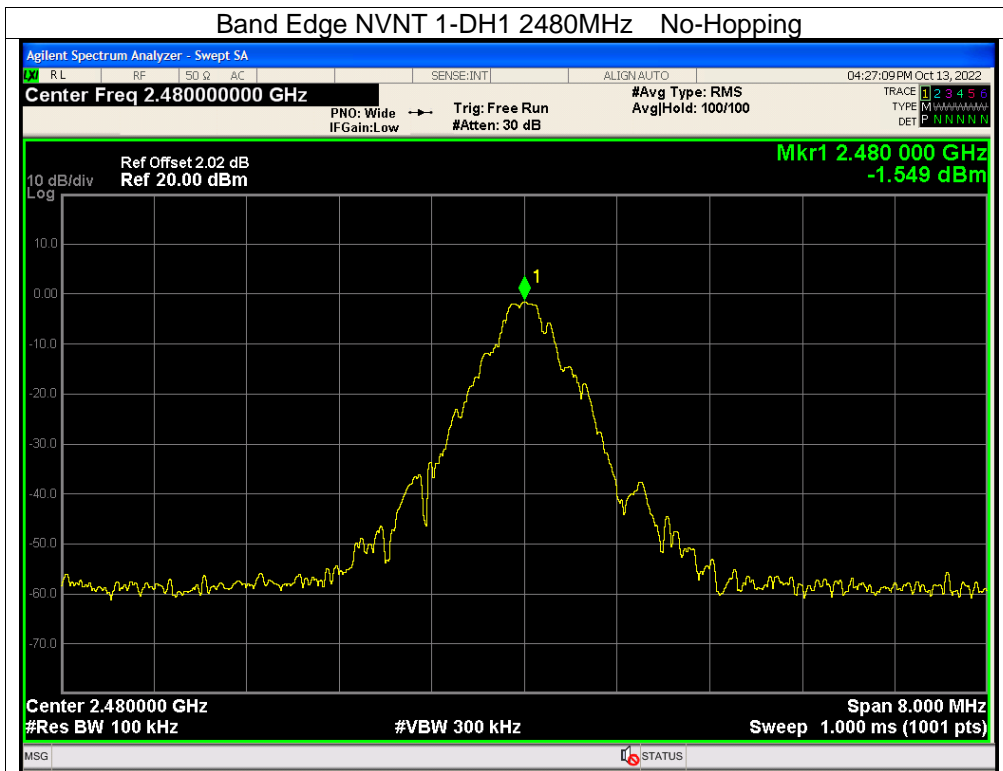

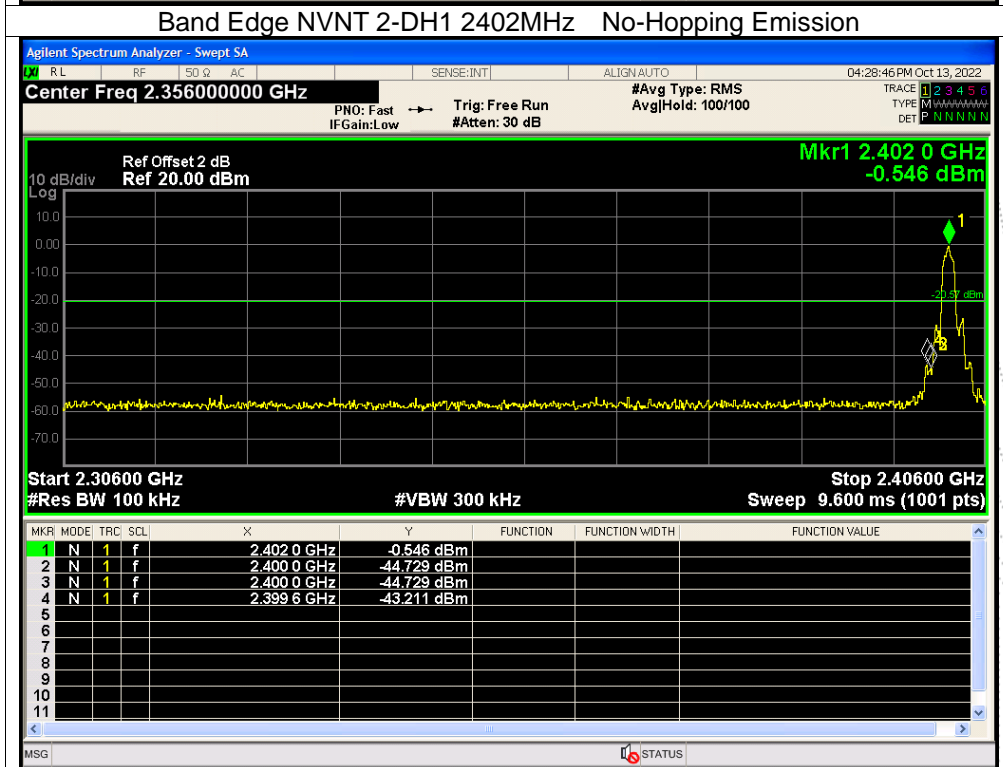
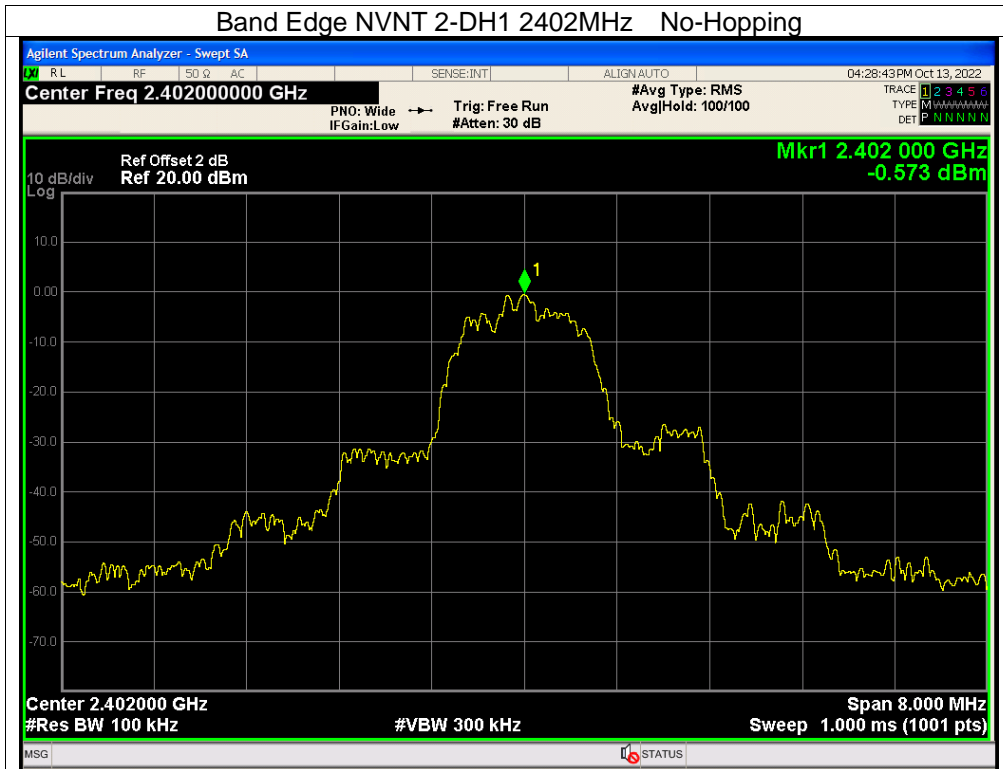



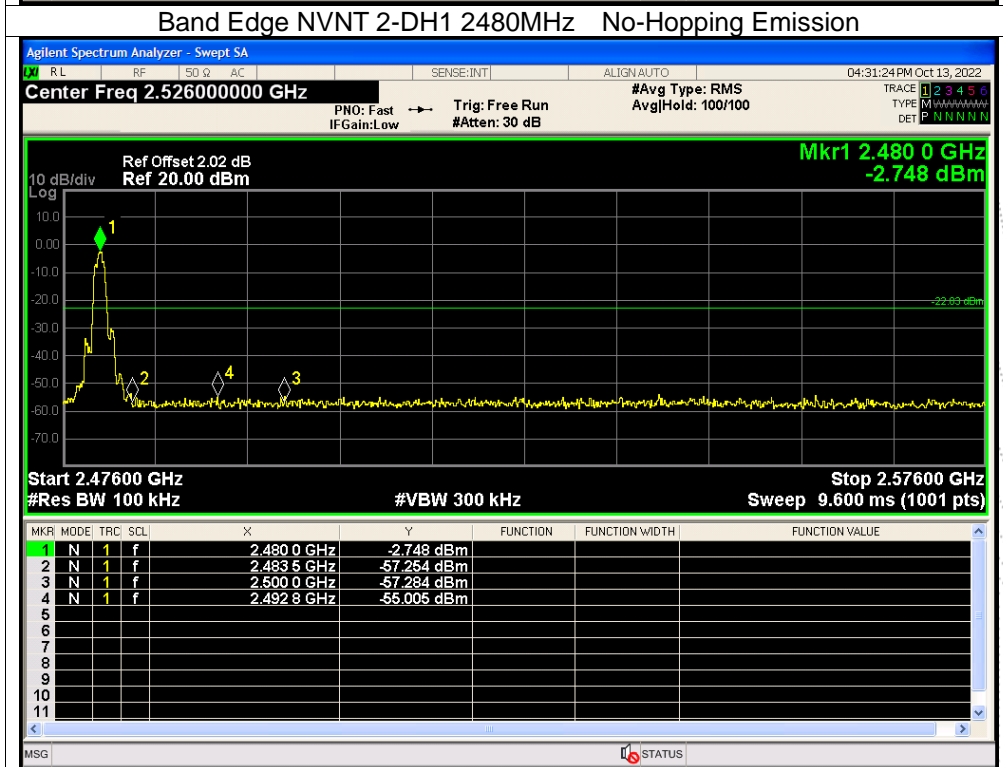

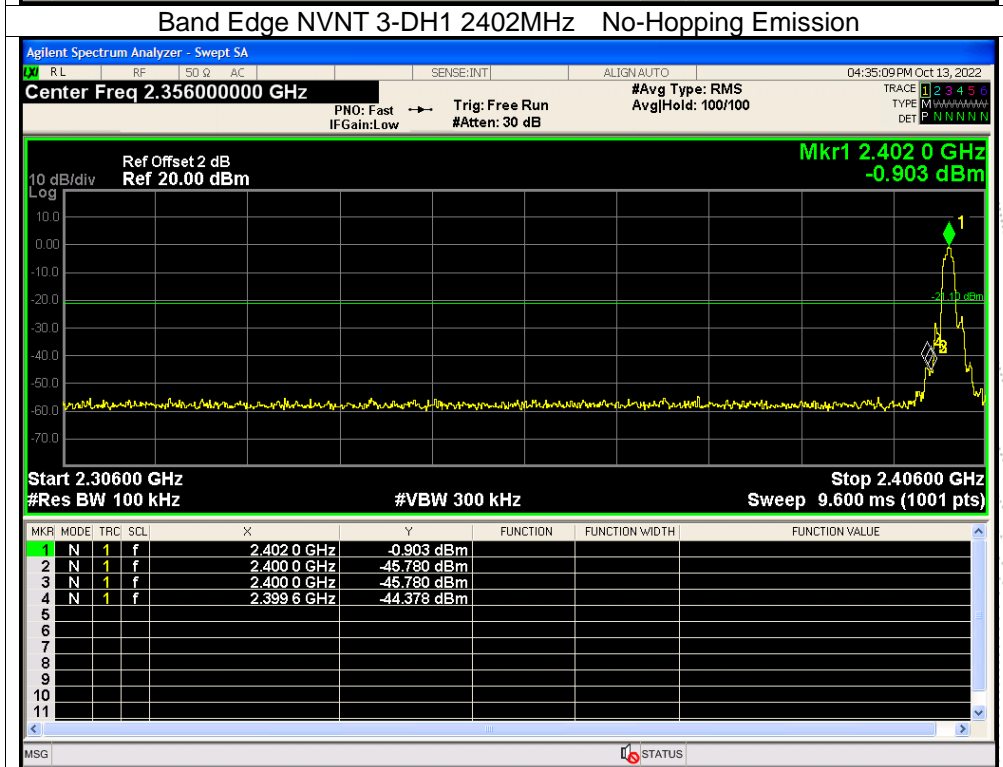
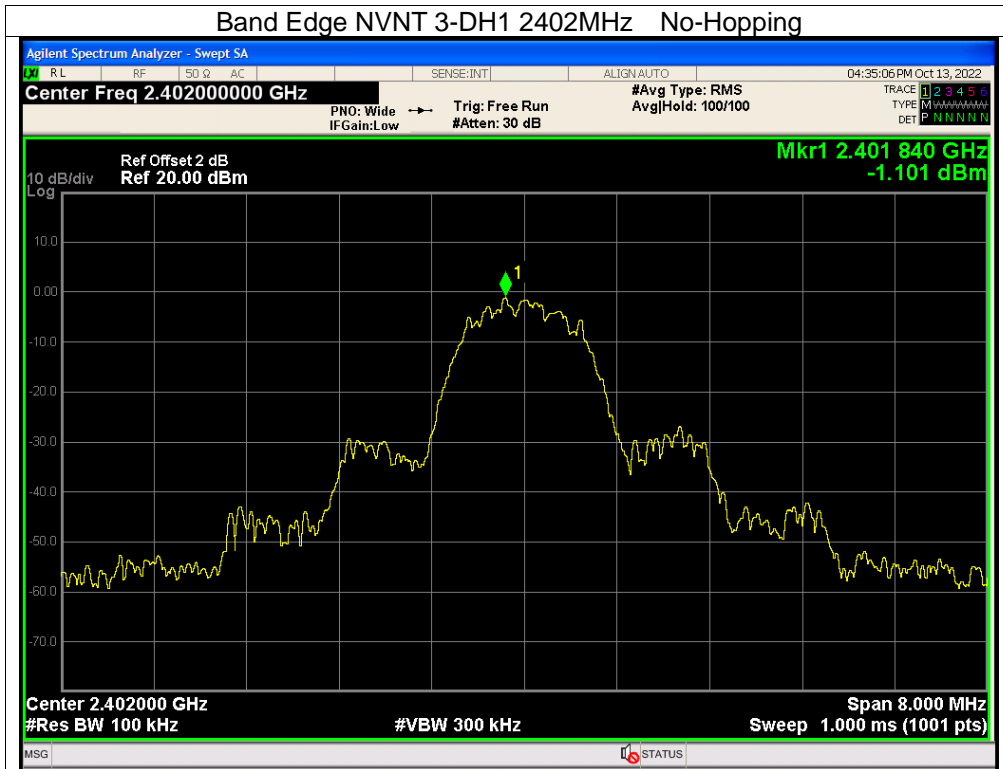

CO. LTD

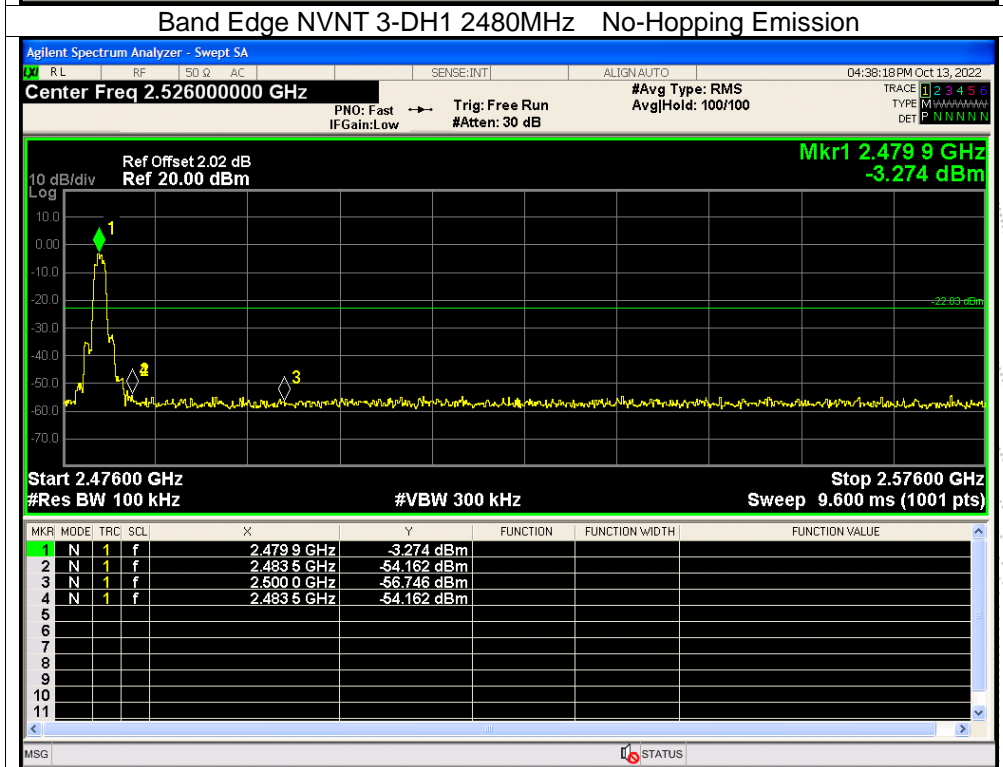

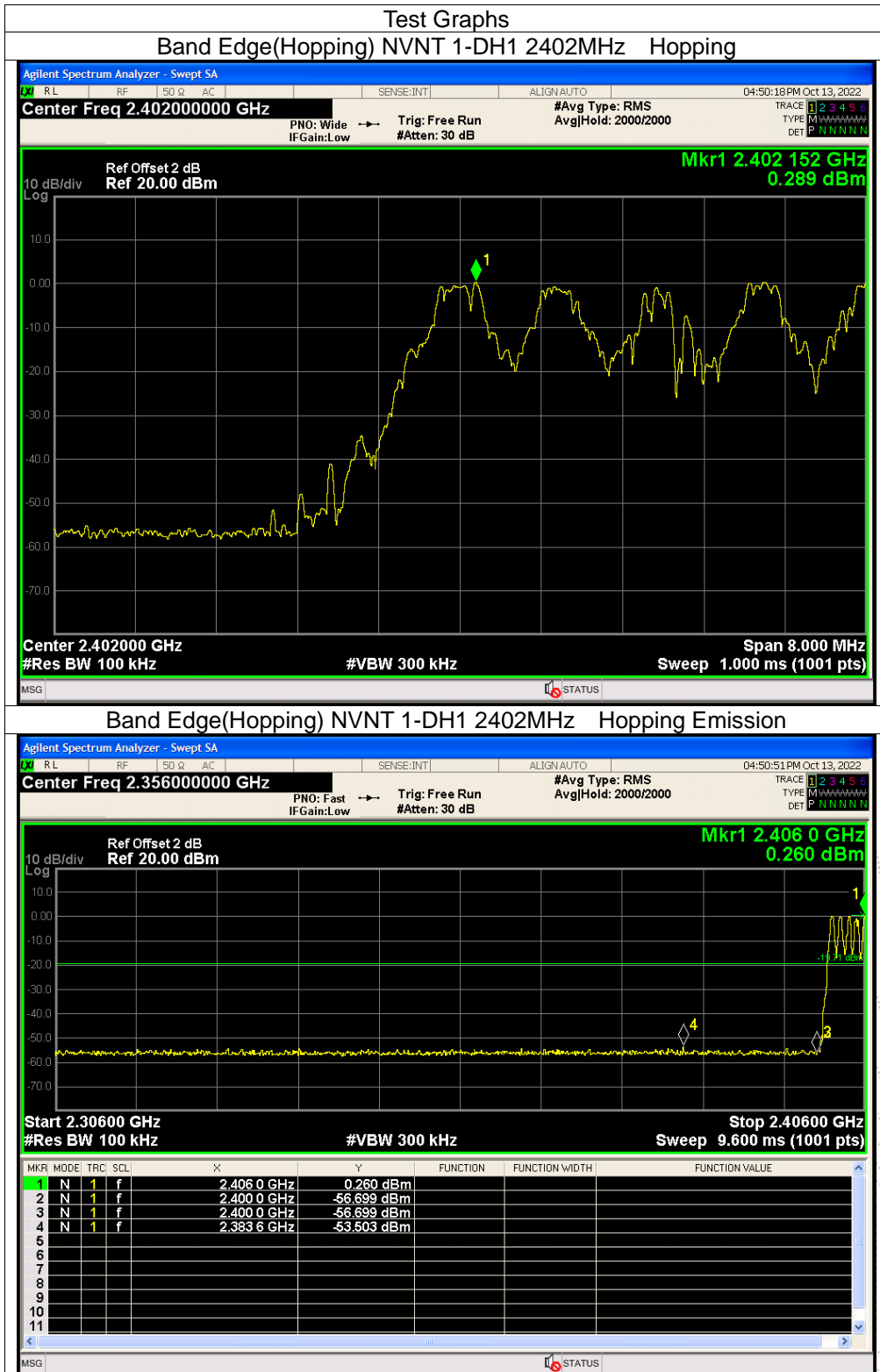

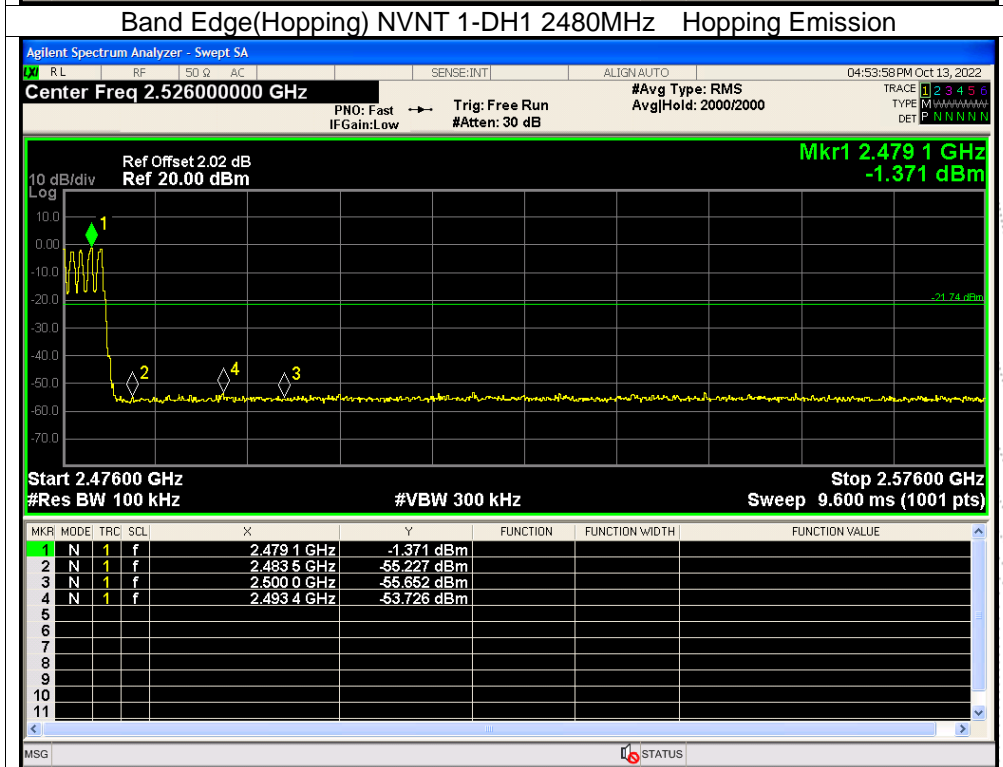
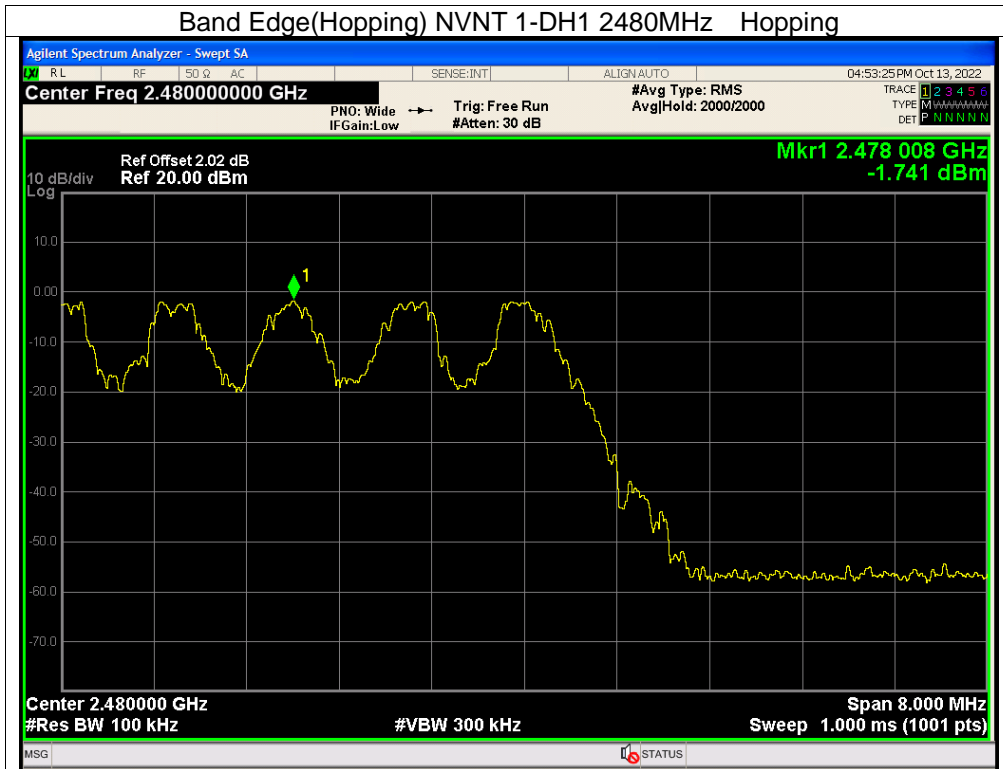

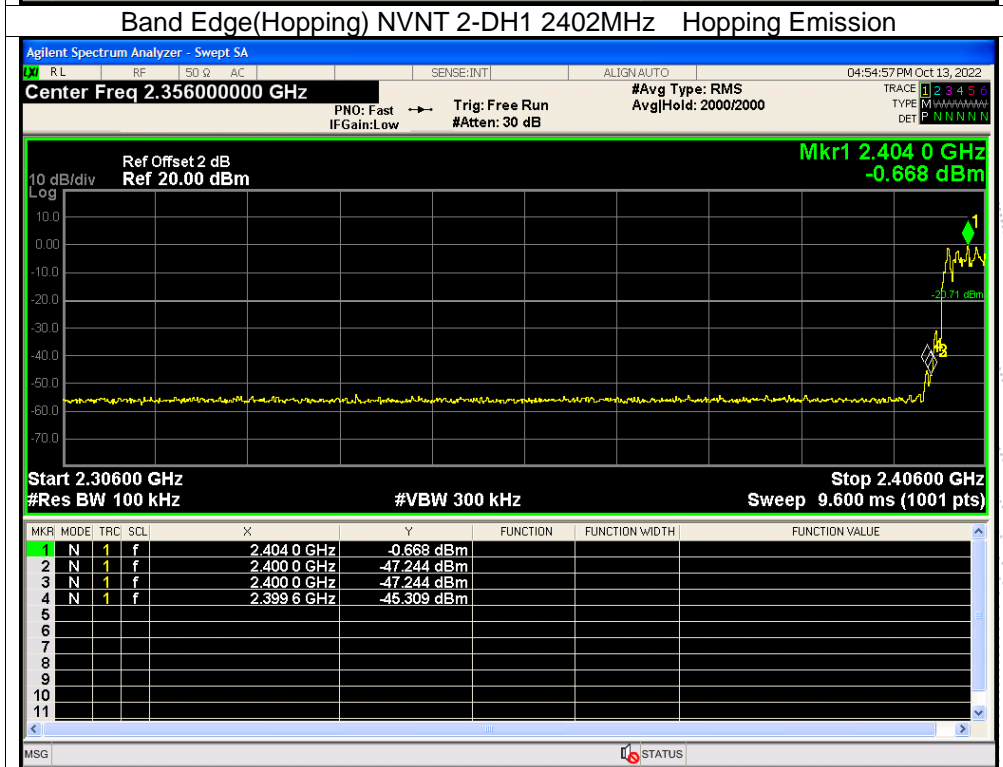

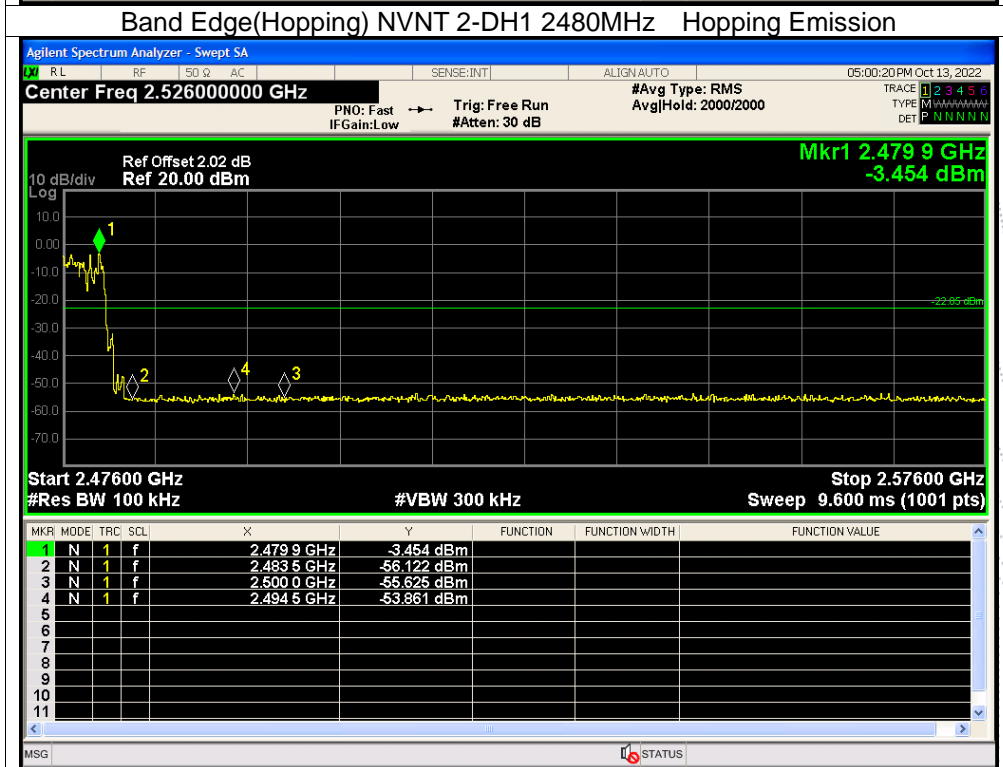

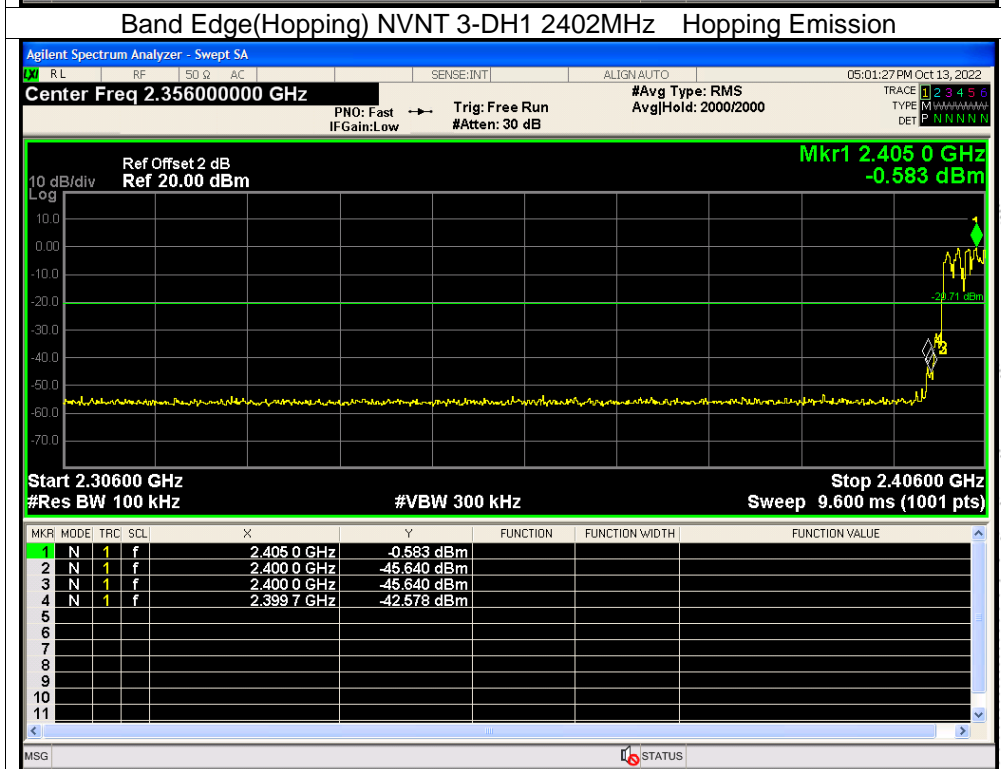
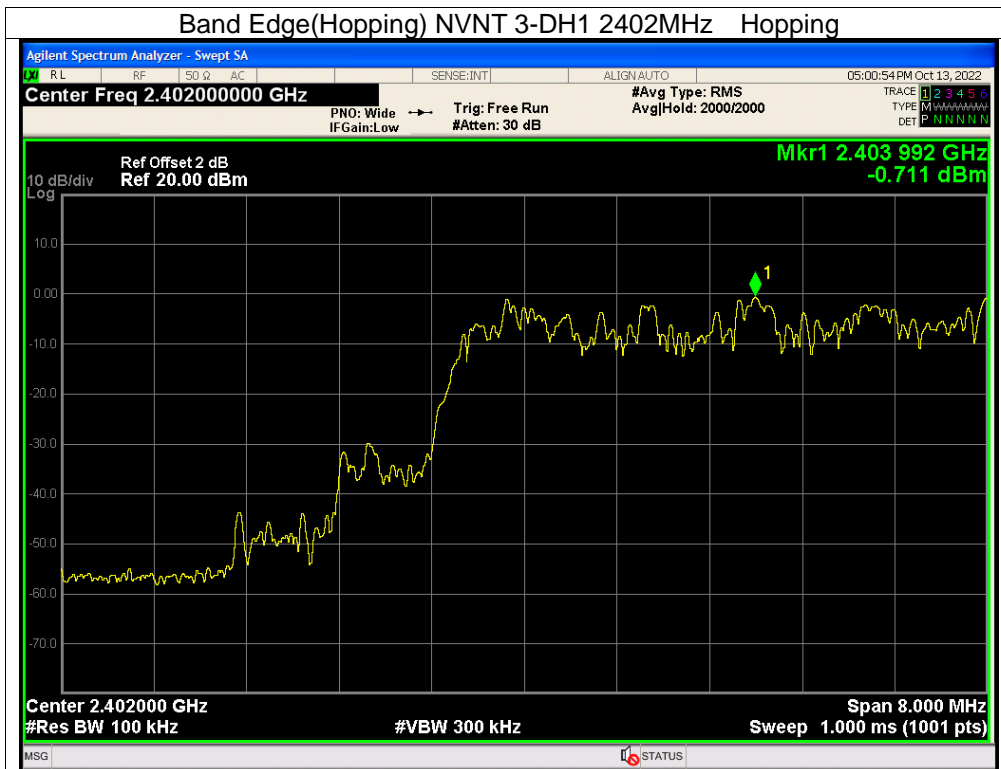

CO. LTD



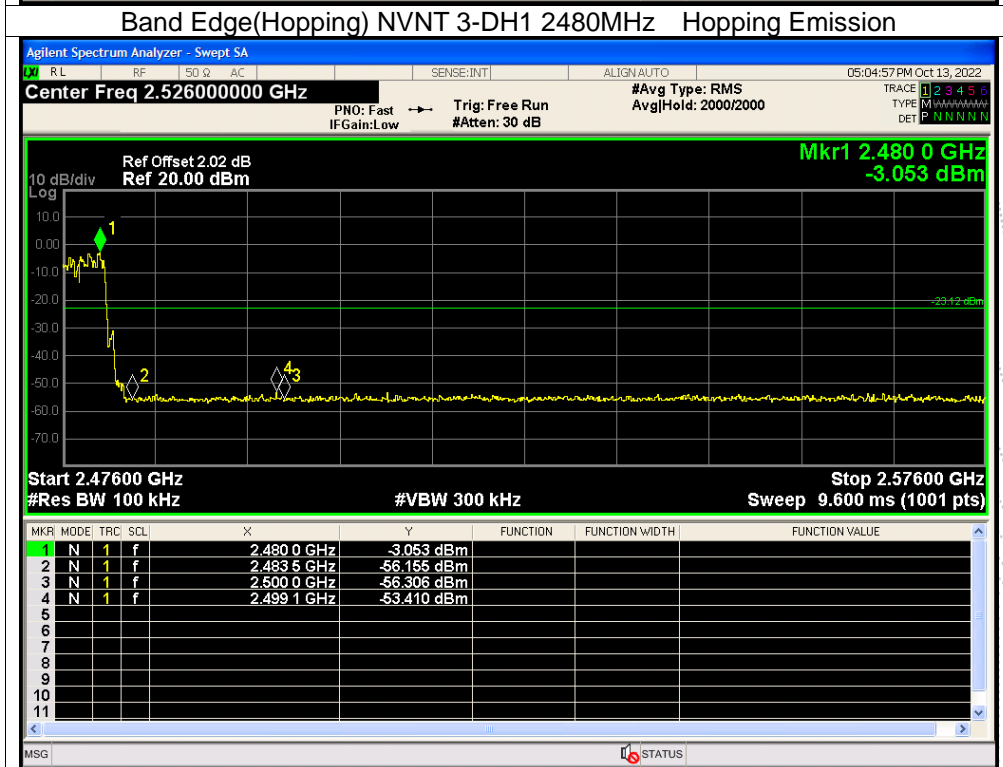

SHENZHEN

## 10. 20 DB Bandwidth

### 10.1 Block Diagram Of Test Setup



### 10.2 Limit

N/A

### 10.3 Test Procedure

1. Set RBW = 30kHz.
2. Set the video bandwidth (VBW)  $\geq 3 \times$  RBW.
3. Detector = Peak.
4. Trace mode = max hold.
5. Sweep = auto couple.
6. Allow the trace to stabilize.
7. Measure the maximum width of the emission that is constrained by the frequencies associated with the two outermost amplitude points (upper and lower frequencies) that are attenuated by 20 dB relative to the maximum level measured in the fundamental emission. .



## 10.4 Test Result

Temperature :	26°C	Relative Humidity :	54%
Test Voltage :	DC 5V	Remark	N/A

Condition	Mode	Frequency (MHz)	-20 dB Bandwidth (MHz)	99% OBW (MHz)	Verdict
NVNT	1-DH1	2402	1.042	0.925	Pass
NVNT	1-DH1	2441	1.033	0.957	Pass
NVNT	1-DH1	2480	1.024	0.924	Pass
NVNT	2-DH1	2402	1.356	1.258	Pass
NVNT	2-DH1	2441	1.355	1.182	Pass
NVNT	2-DH1	2480	1.353	1.213	Pass
NVNT	3-DH1	2402	1.304	1.197	Pass
NVNT	3-DH1	2441	1.3	1.215	Pass
NVNT	3-DH1	2480	1.305	1.198	Pass

BCTC  
 3C  
 PPR  
 检测

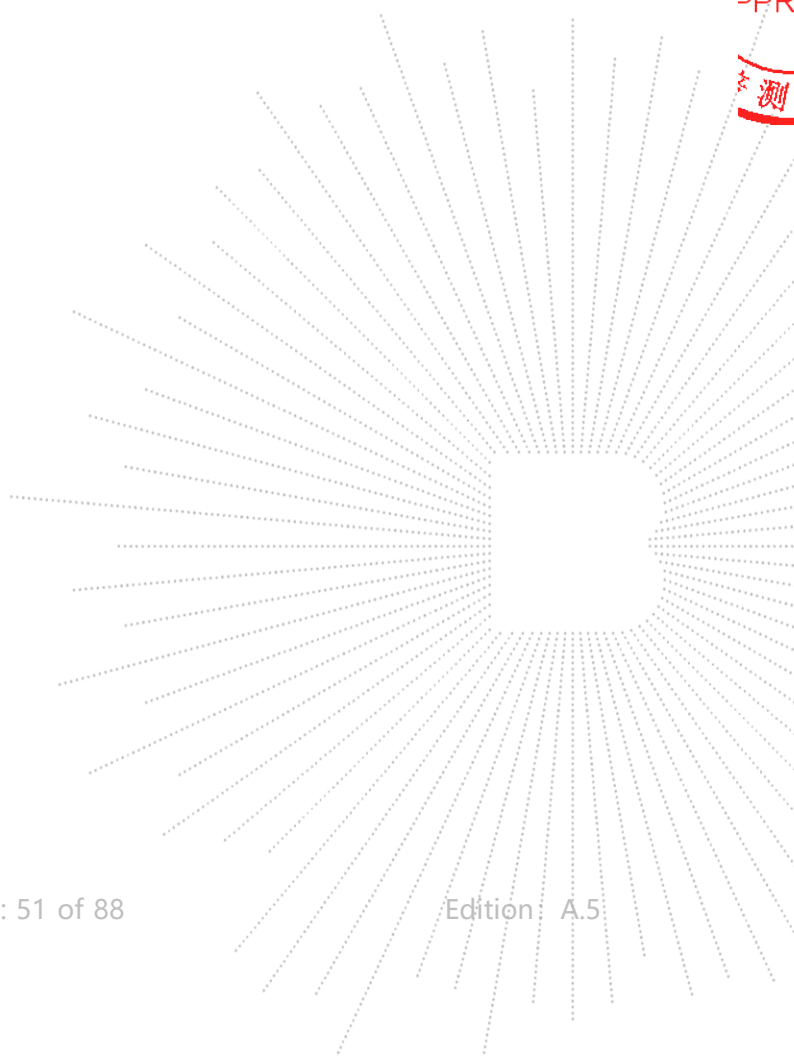

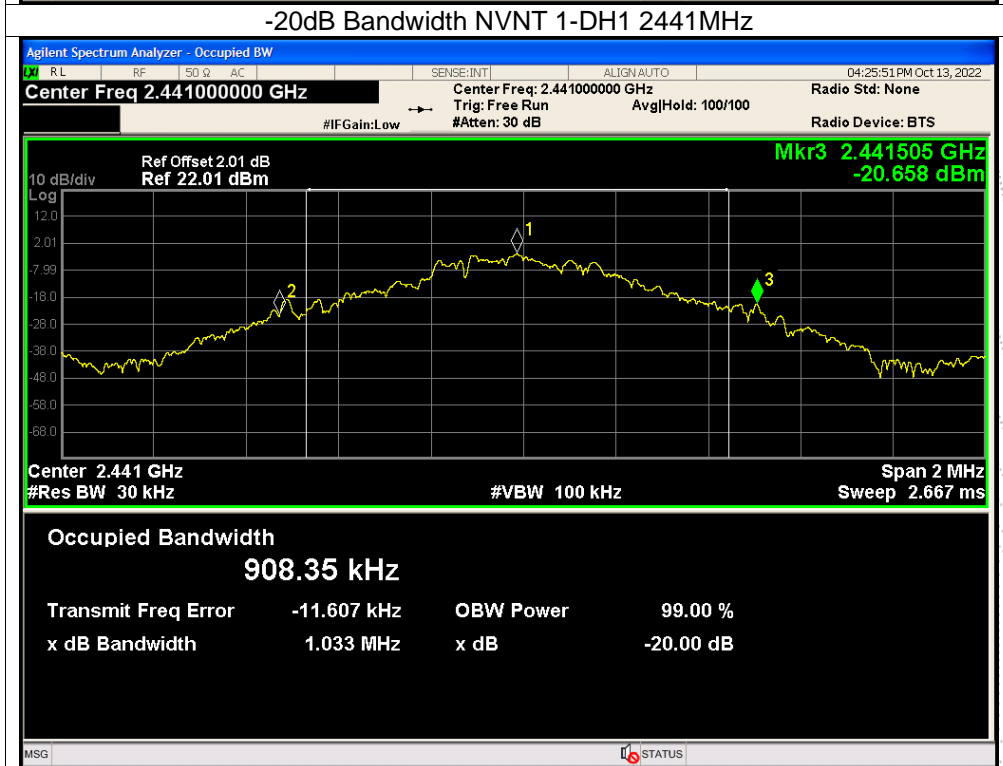
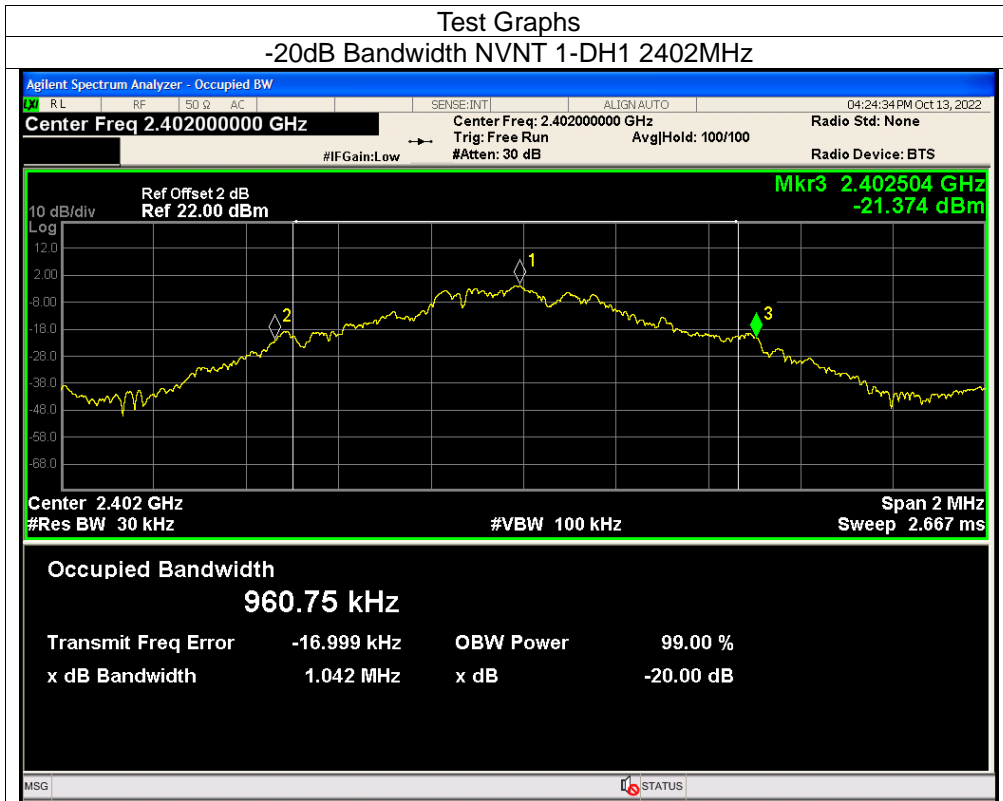

TEC  
TO  
OVER  
檢



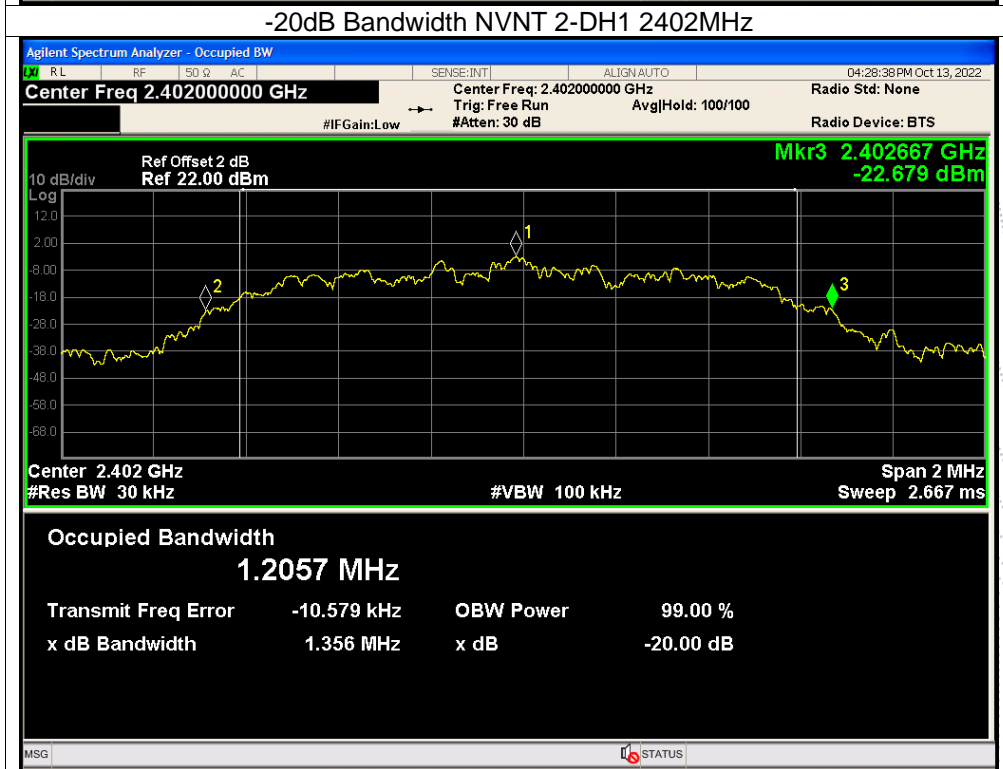
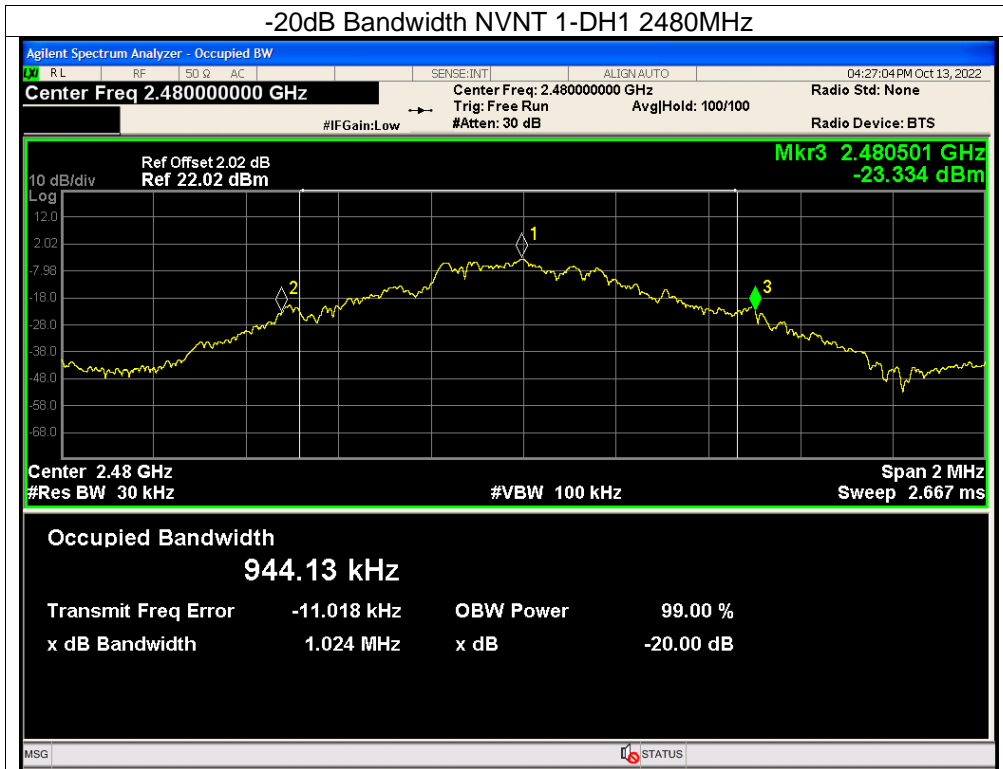

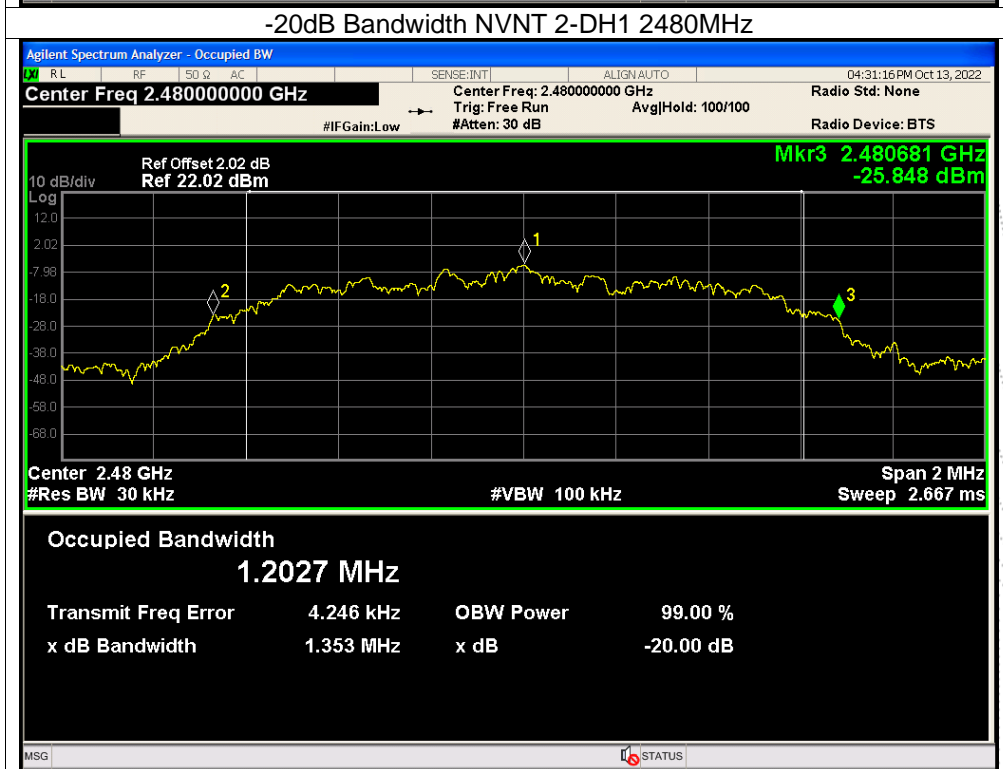
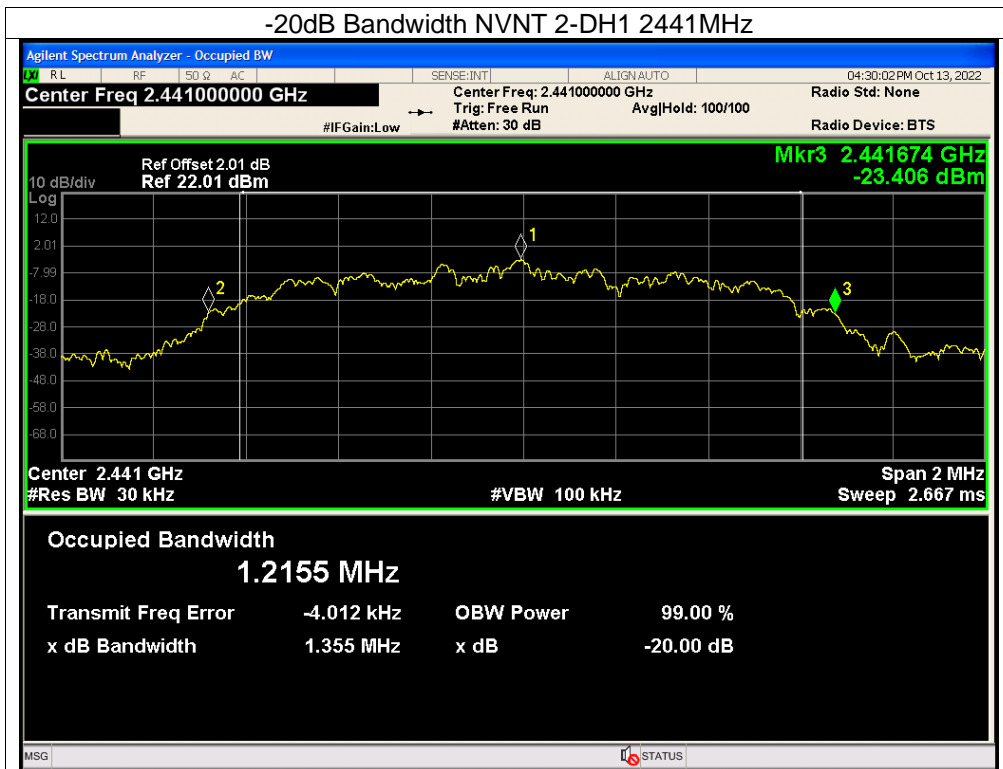

CO.LTD

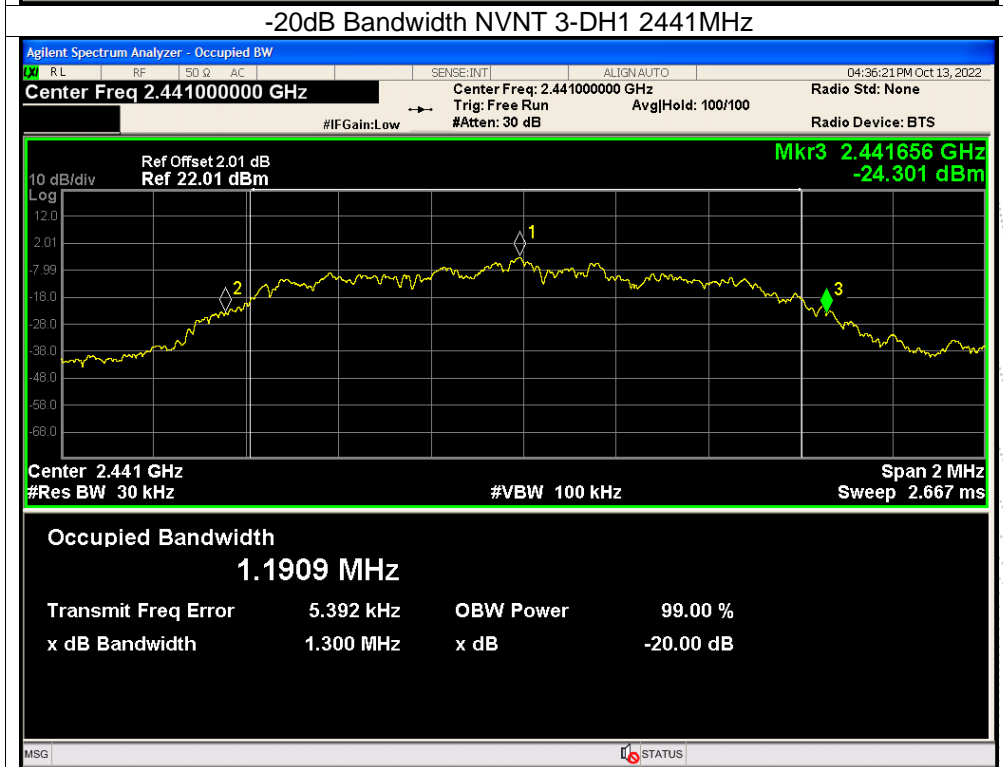
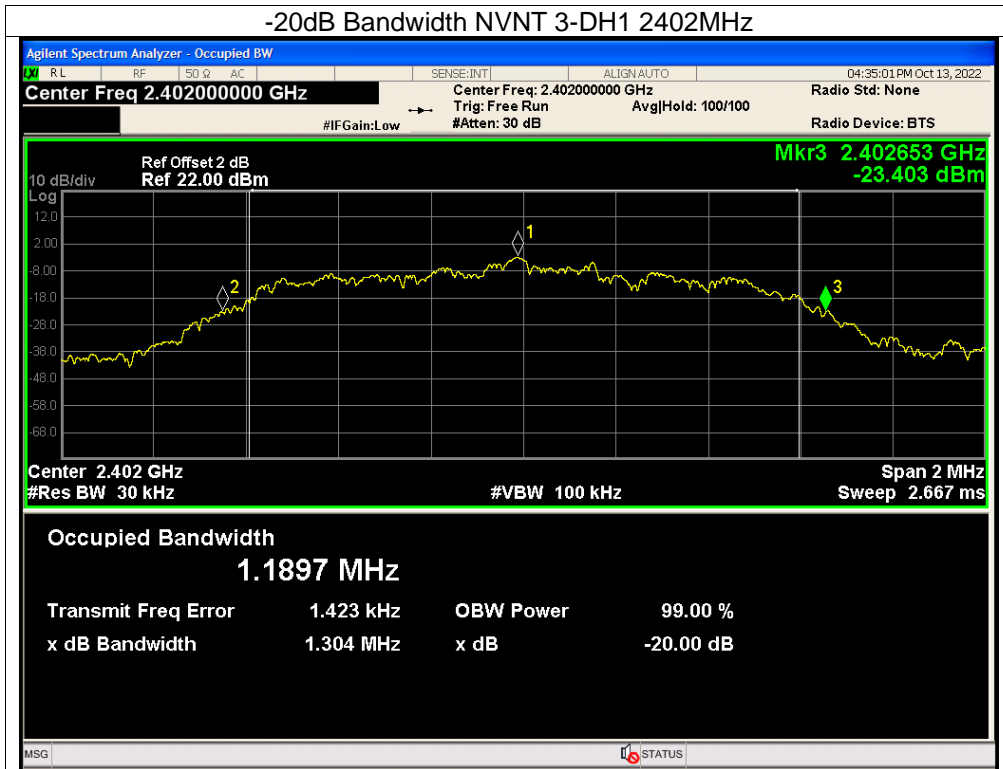

CHENZHEN

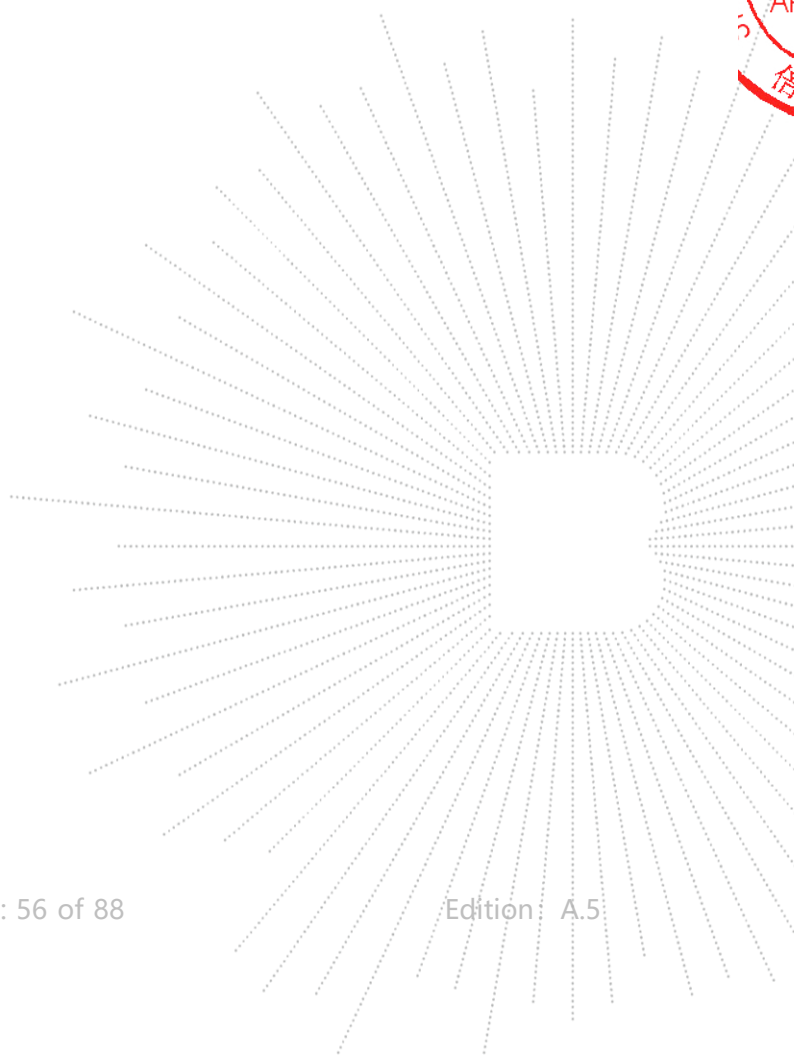
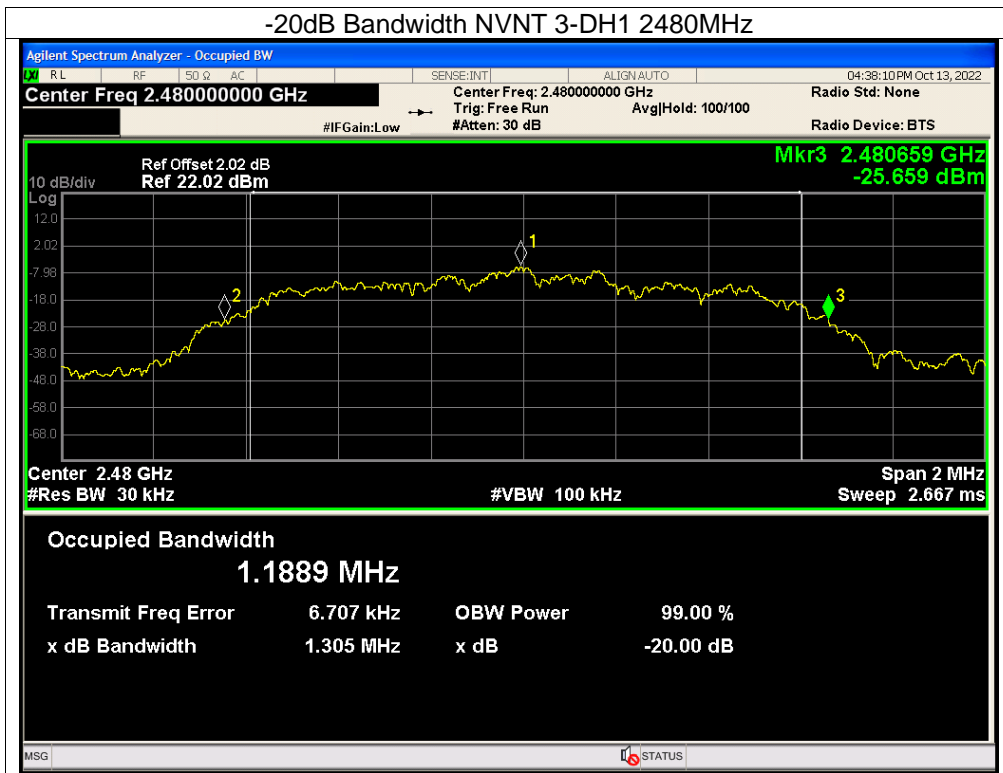



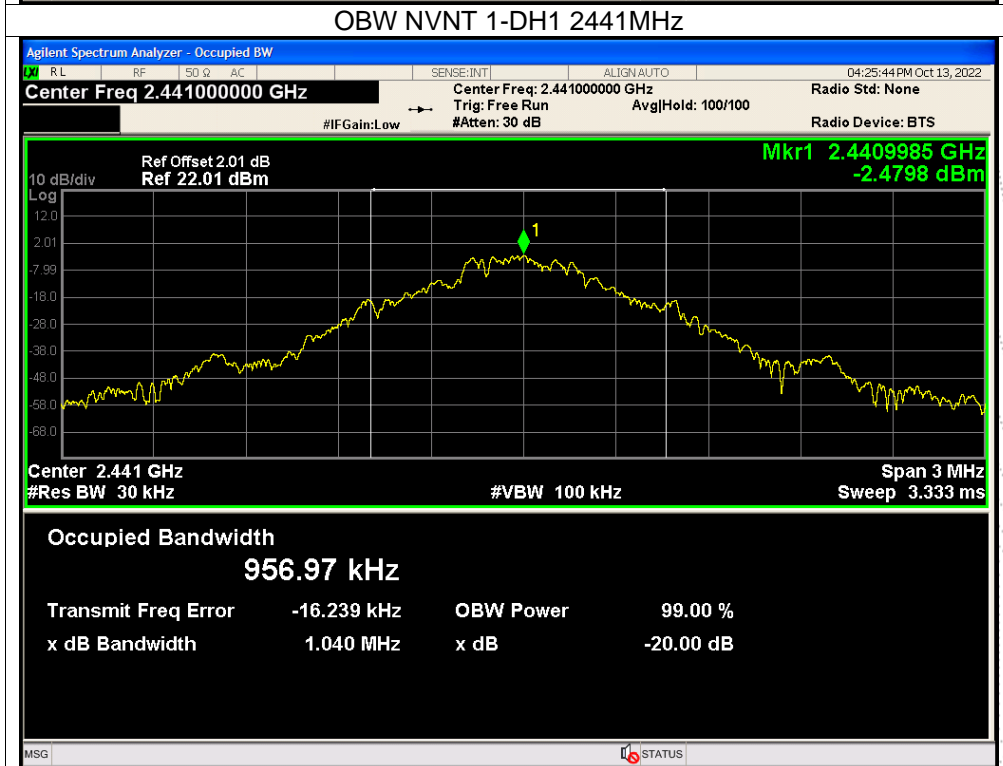
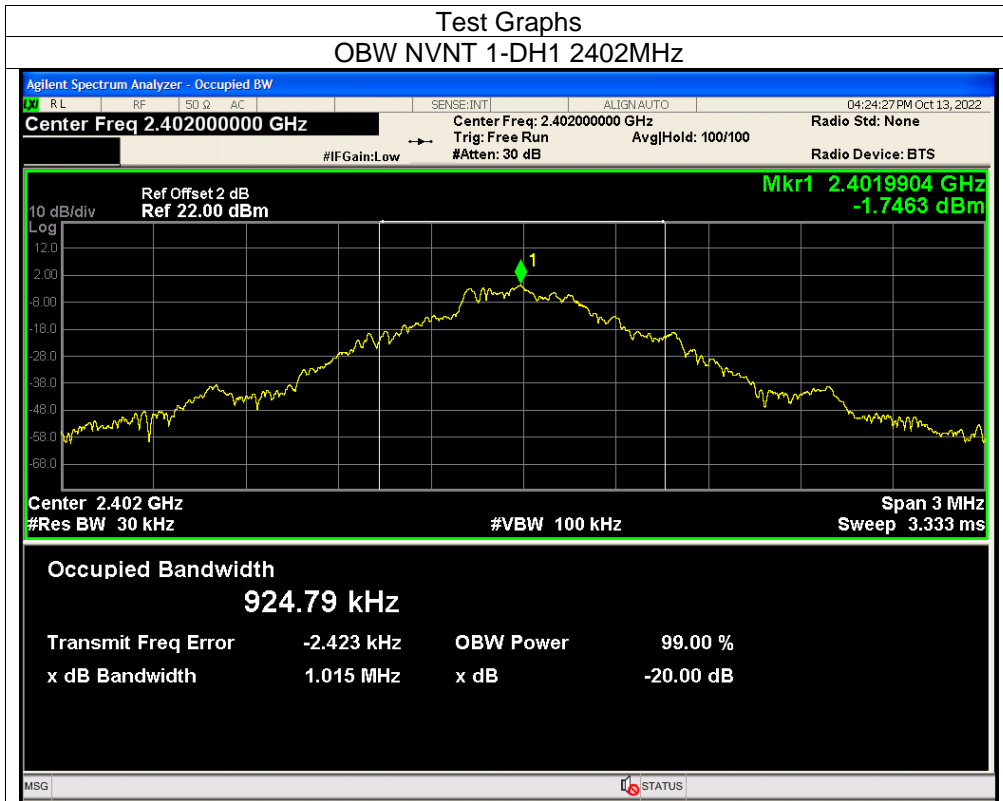

TC  
 3C  
 PPR  
 检测



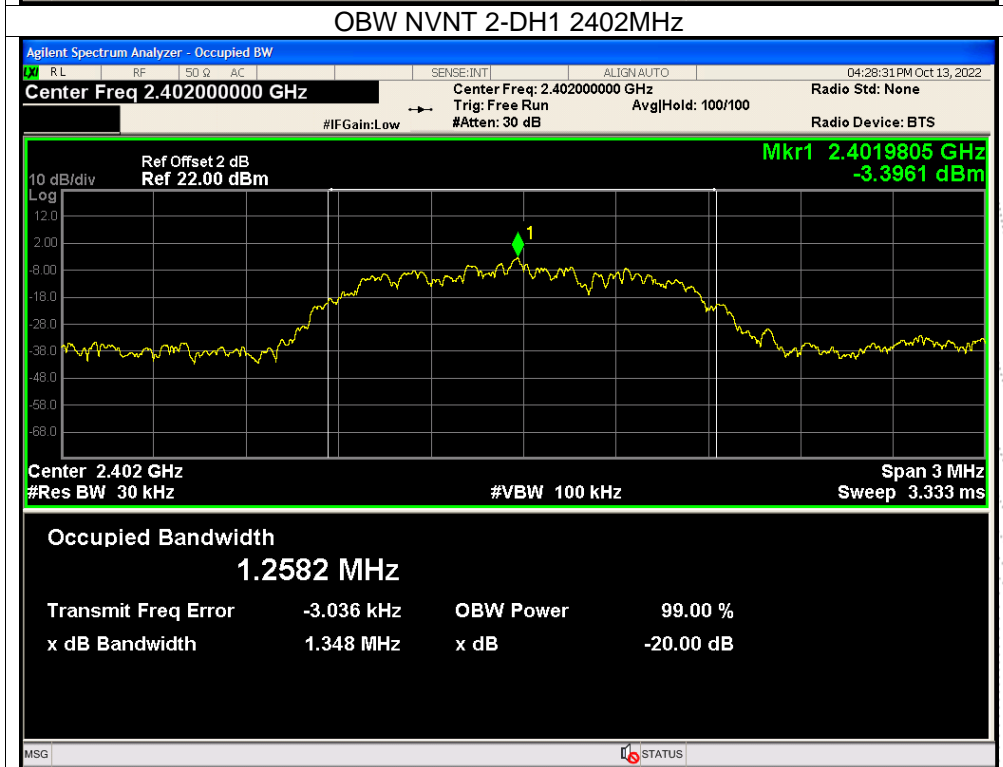
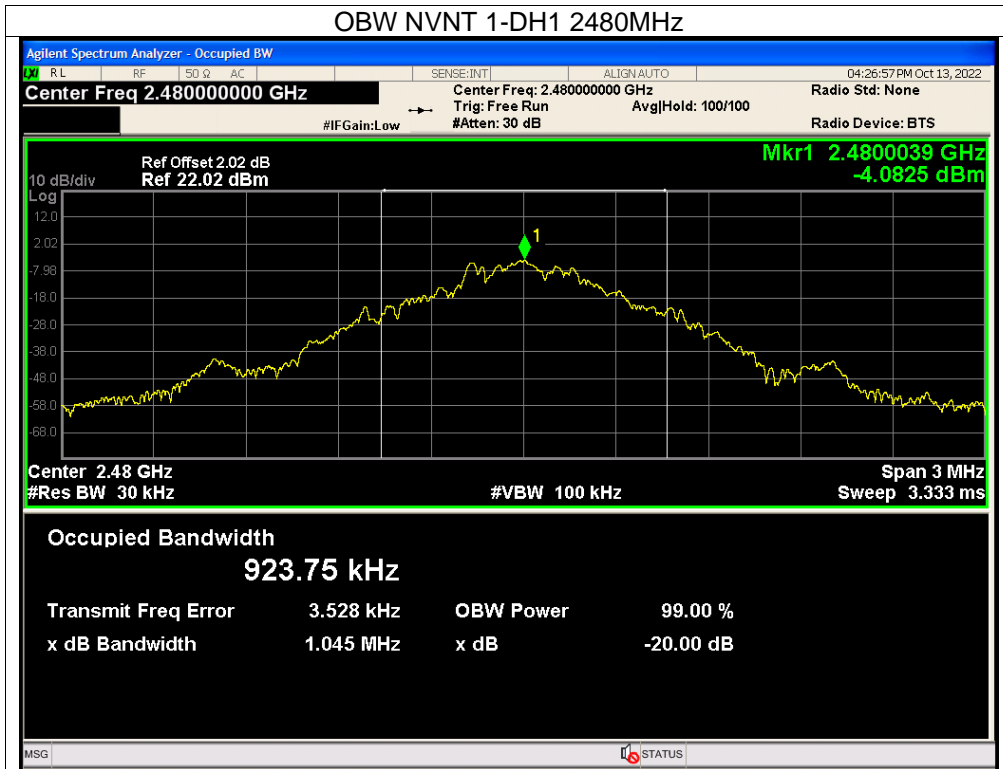

TEC  
TC  
OVB  
檢

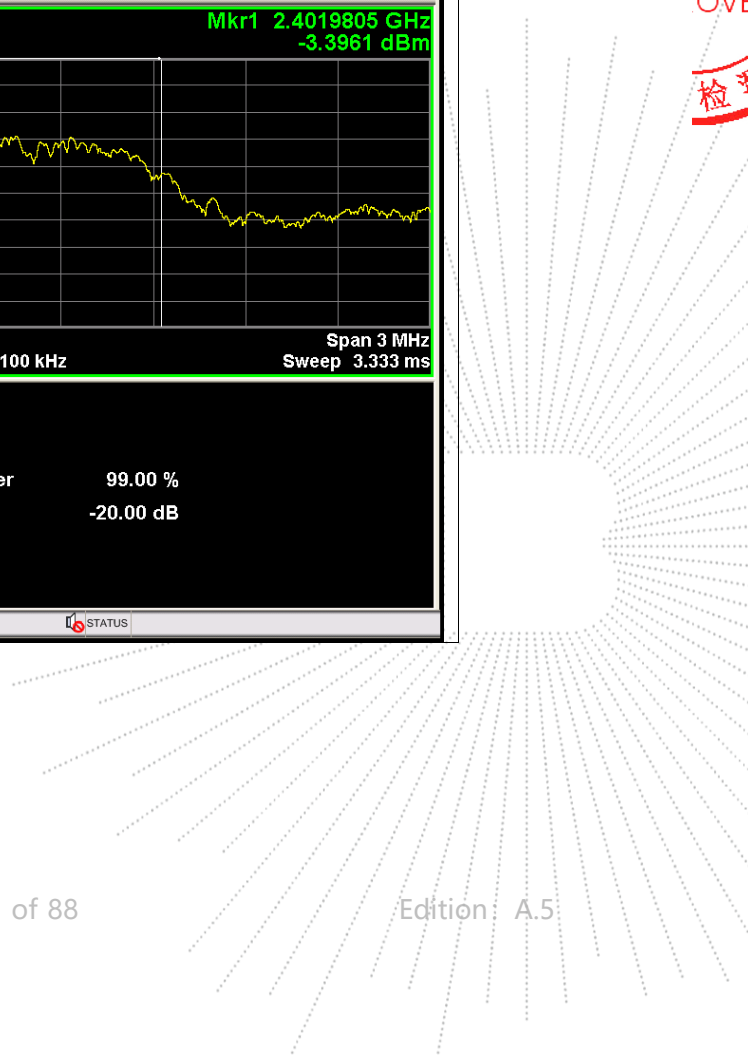

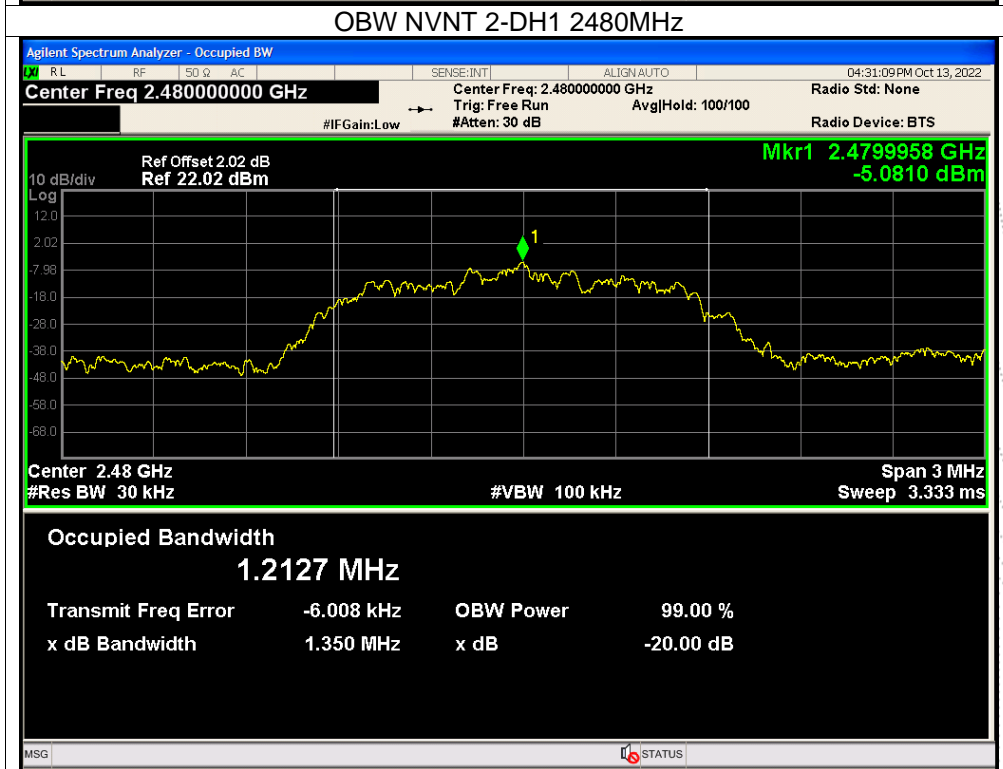
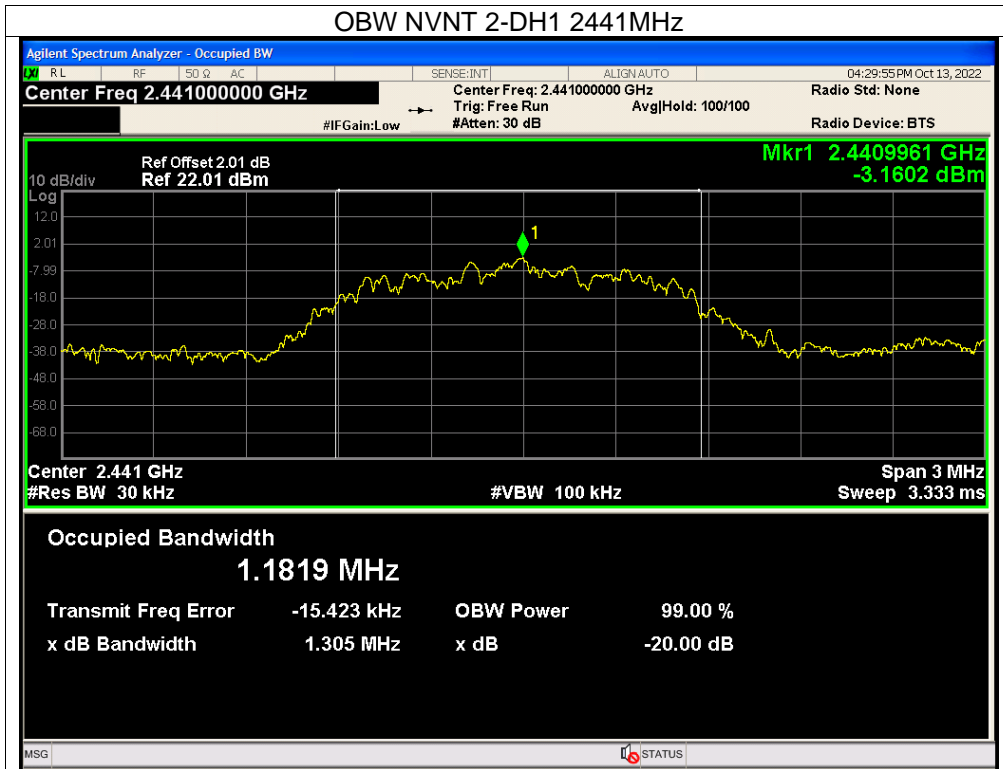

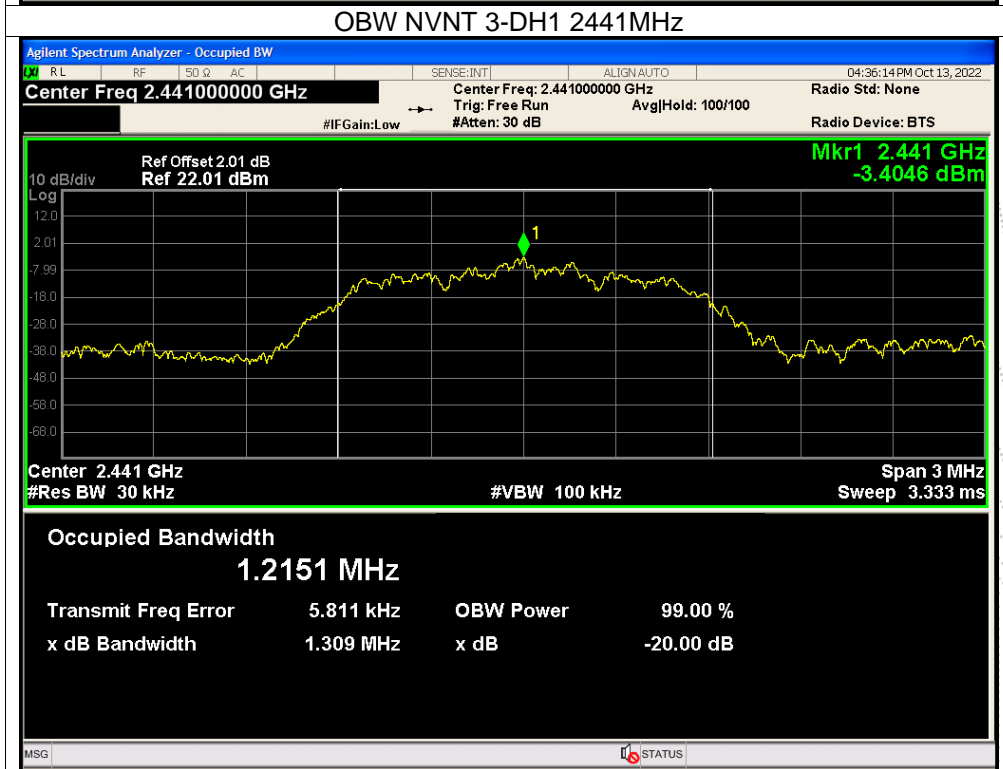
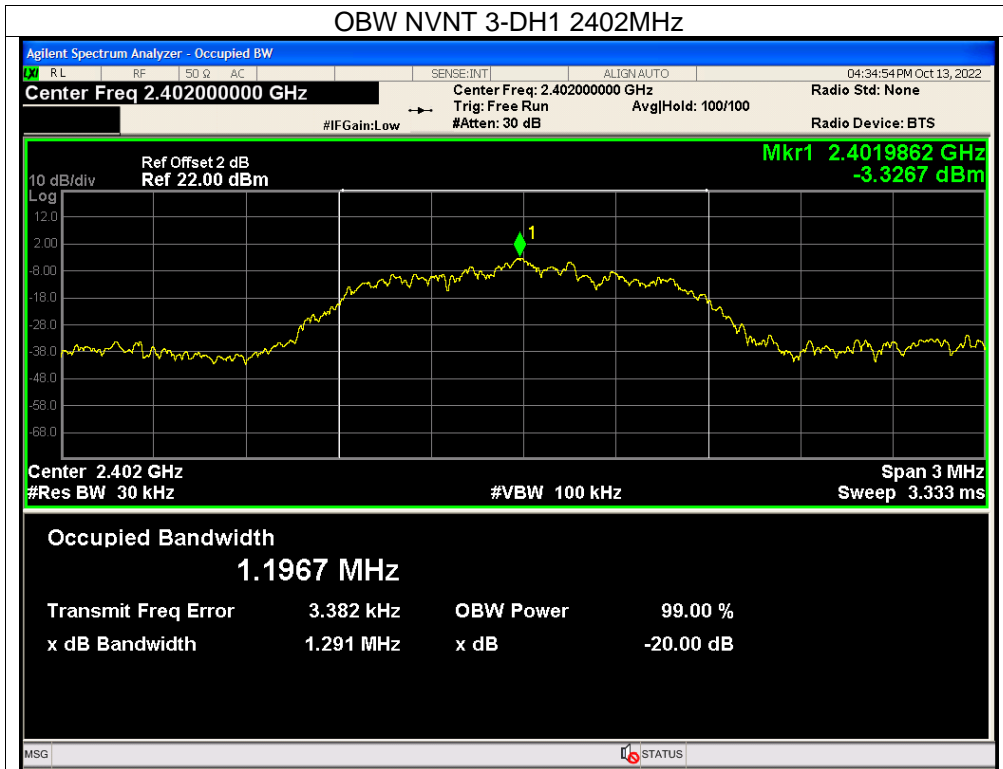

CO.LTD

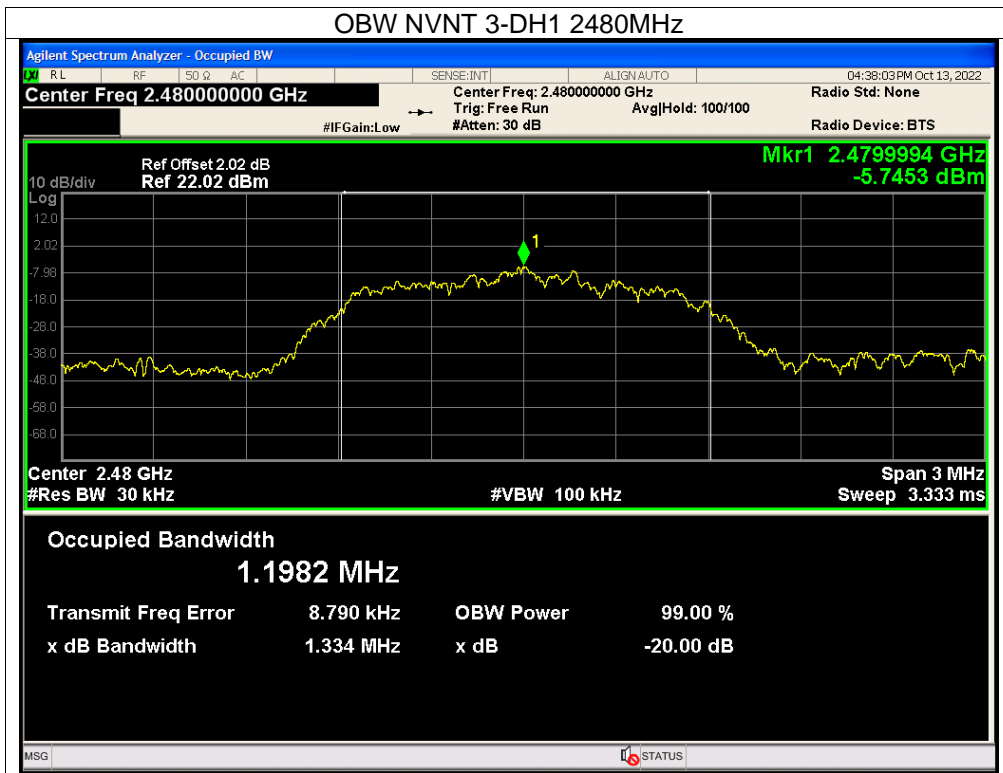

SHENZHEN

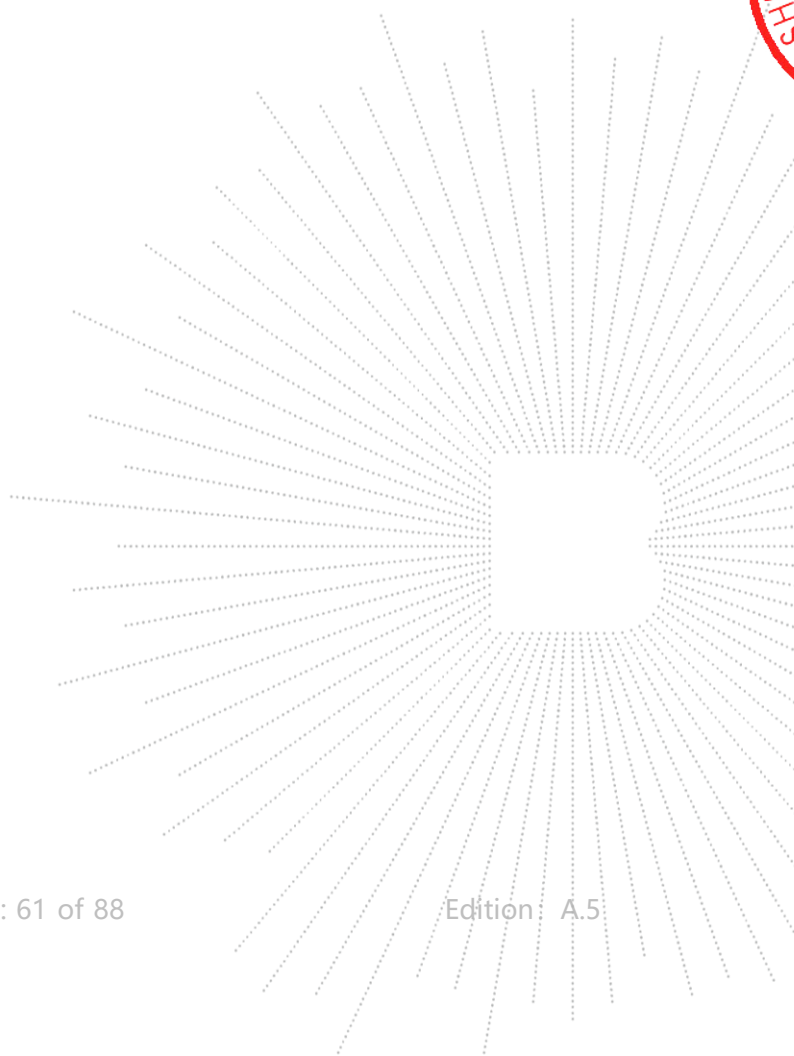

## 11. Maximum Peak Output Power

### 11.1 Block Diagram Of Test Setup

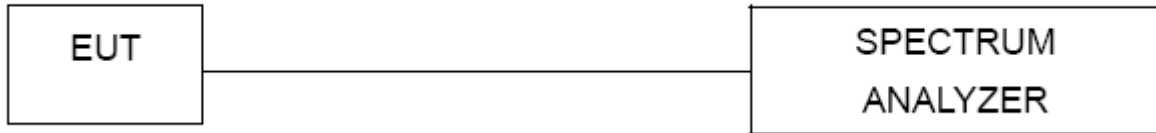

### 11.2 Limit

RSS-247 Clause 5.4(b)					
Section	Test Item	Limit (connected Power)	Limit(EIRP)	Frequency Range (MHz)	Result
RSS-247 Clause 5.4(b)	Peak Output Power	0.125 watt or 21dBm	4W or 36dBm	2400-2483.5	PASS

### 11.3 Test Procedure

1. Remove the antenna from the EUT and then connect a low RF cable from the antenna port to the spectrum.
2. Set the spectrum analyzer: RBW = 3MHz. VBW = 3MHz. Sweep = auto; Detector Function = Peak.
3. Keep the EUT in transmitting at lowest, medium and highest channel individually. Record the max value.

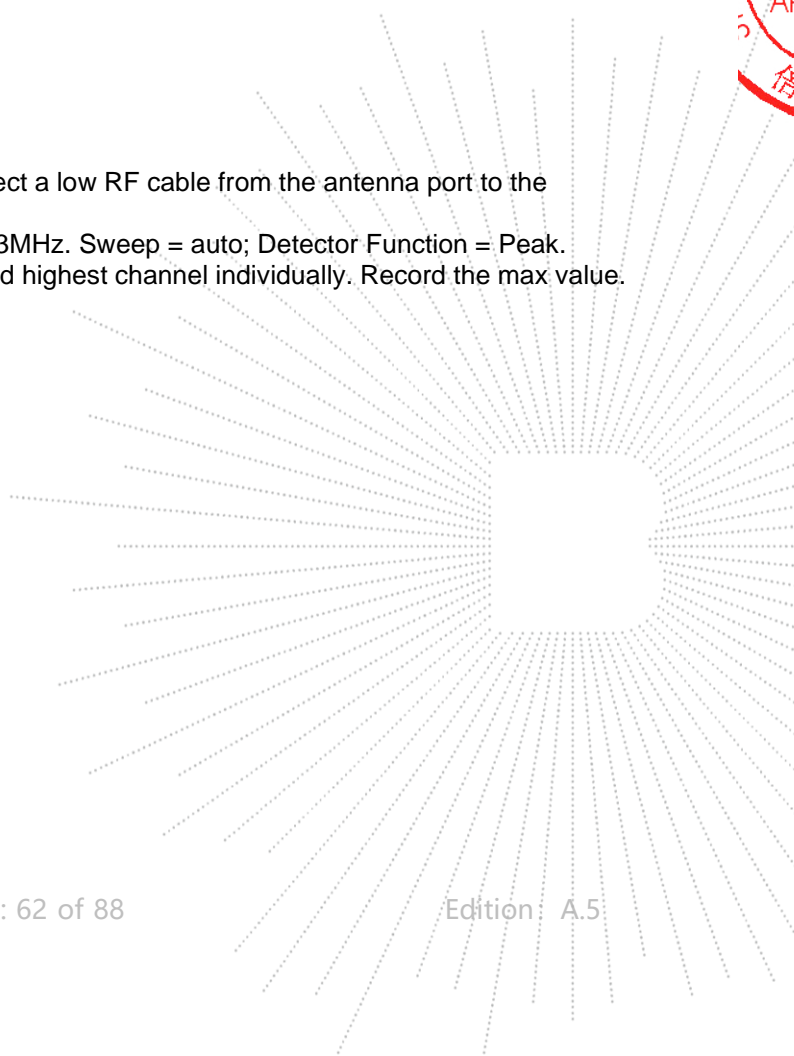

## 11.4 Test Result

Temperature :	26°C	Relative Humidity :	54%
Test Voltage :	DC 5V	Remark:	N/A

Condition	Mode	Frequency (MHz)	Conducted Power (dBm)	Limit (dBm)	EIRP (dBm)	EIRP Limit (dBm)	Verdict
NVNT	1-DH1	2402	0.65	21	2.15	27	Pass
NVNT	1-DH1	2441	0.65	21	2.15	27	Pass
NVNT	1-DH1	2480	-1.19	21	0.31	27	Pass
NVNT	2-DH1	2402	1.36	21	2.86	27	Pass
NVNT	2-DH1	2441	1.25	21	2.75	27	Pass
NVNT	2-DH1	2480	-0.59	21	0.91	27	Pass
NVNT	3-DH1	2402	1.8	21	3.3	27	Pass
NVNT	3-DH1	2441	1.71	21	3.21	27	Pass
NVNT	3-DH1	2480	-0.19	21	1.31	27	Pass

## Note:

1. Maximum Conducted Output Power= Reading Conducted Output Power+ Offset
2. EIRP= Maximum Conducted Output Power+Antenna gain
3. Antenna gain=1.5 dBi

BCTC  
 3C  
 PPR  
 检测

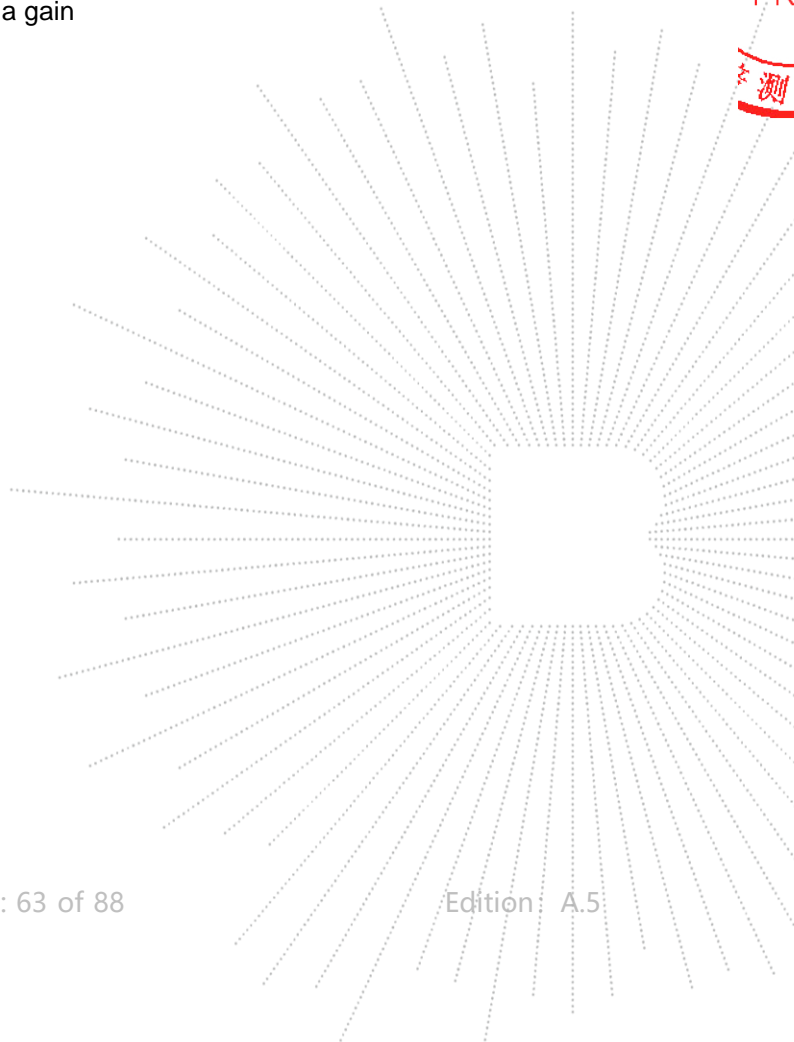

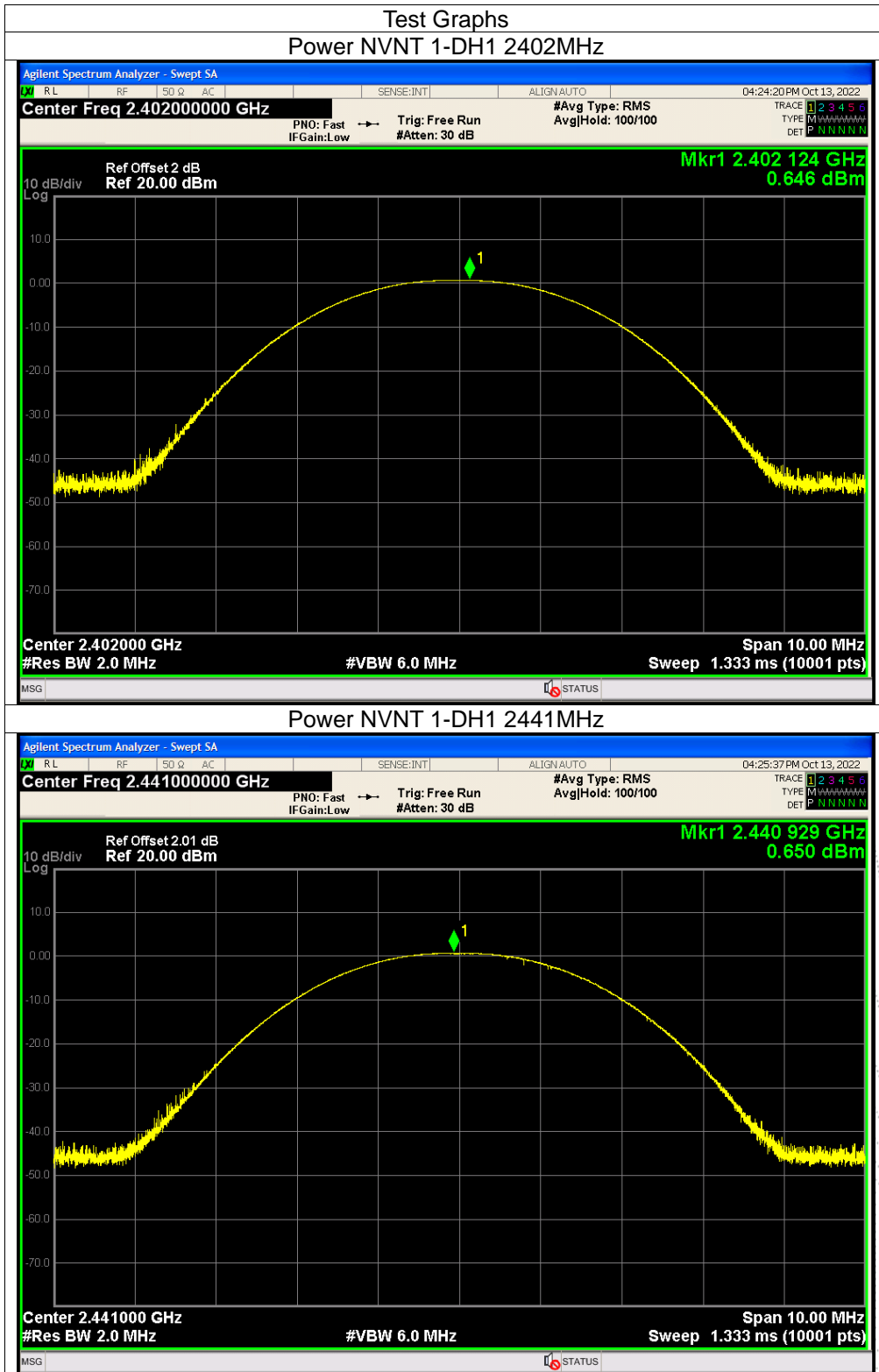



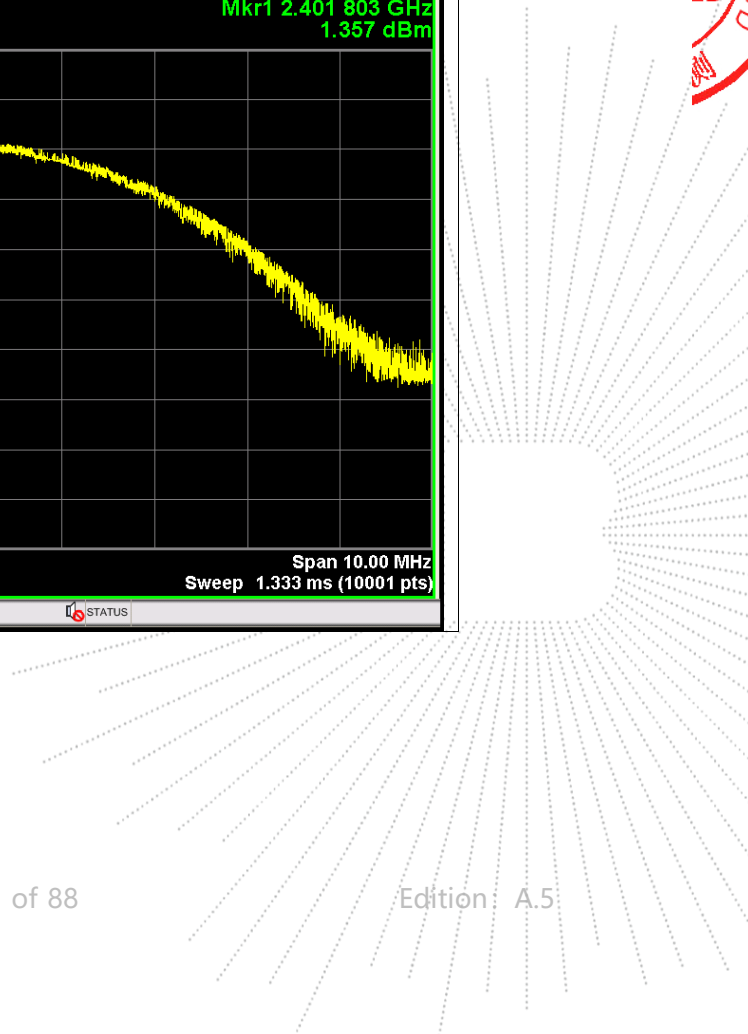
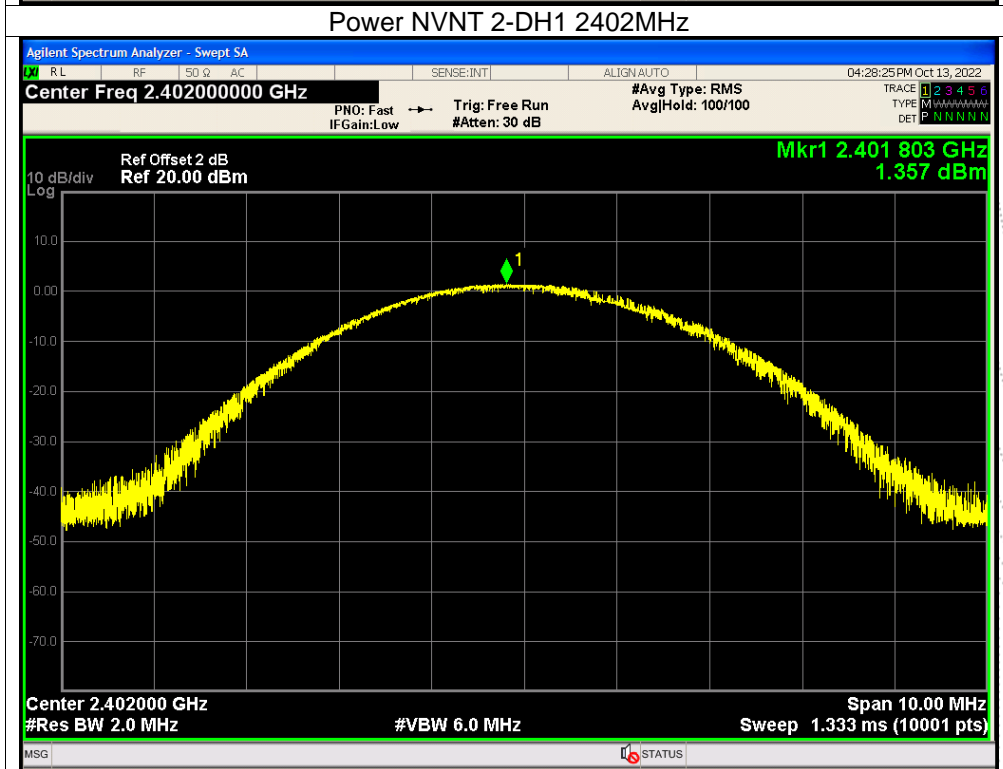
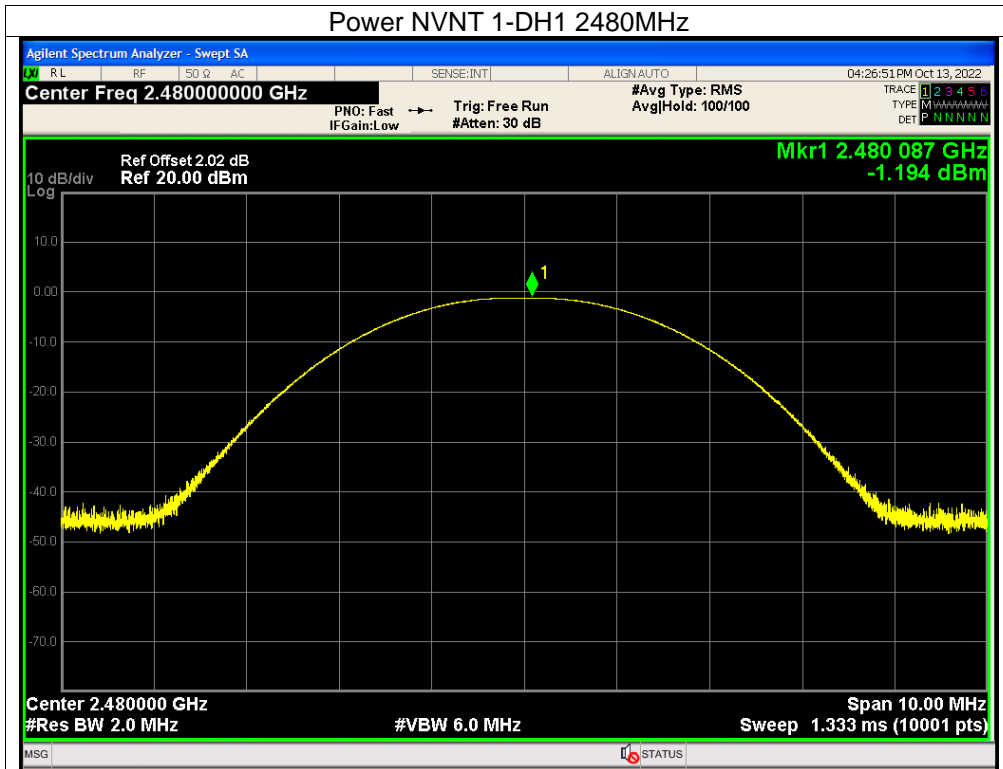

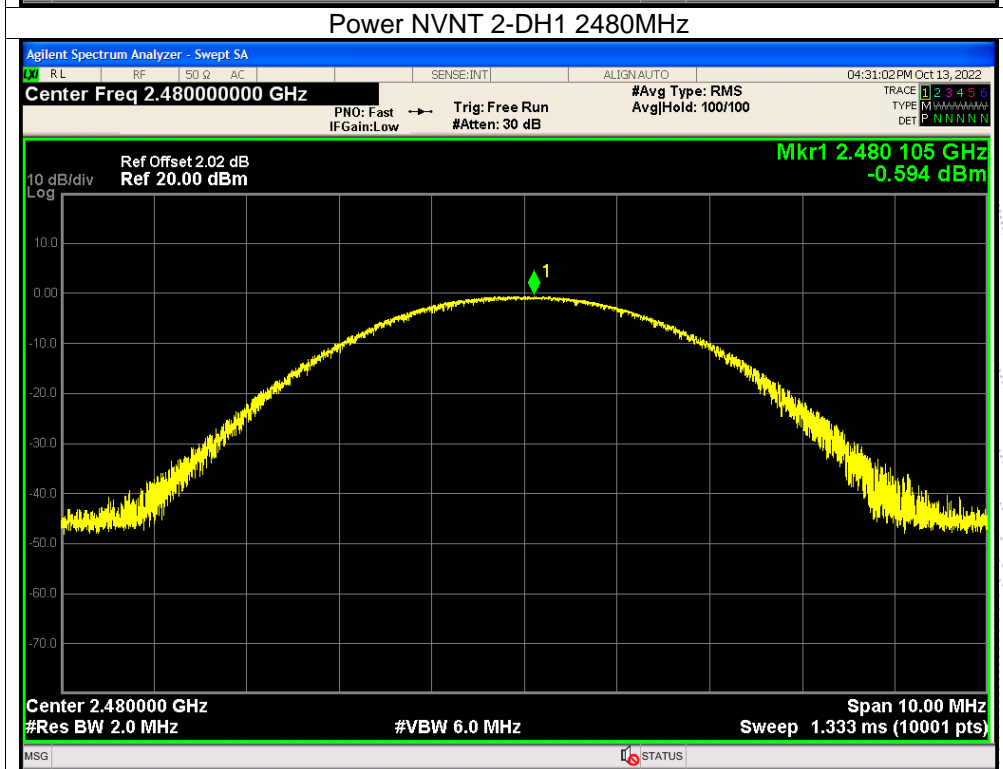
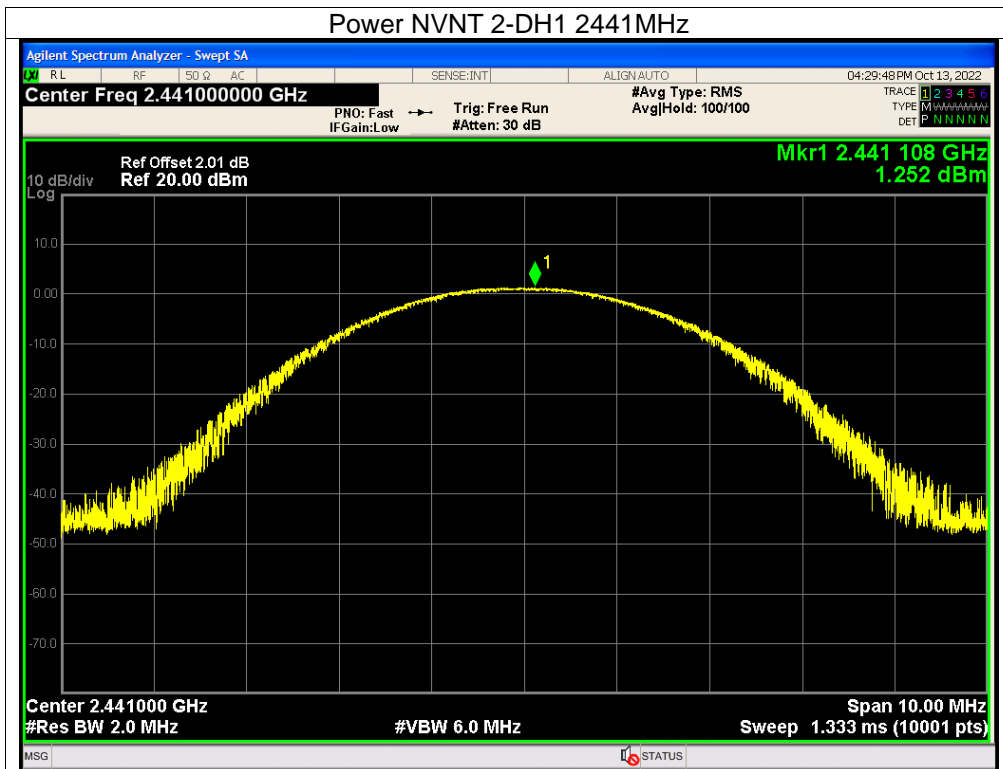

CO., LTD

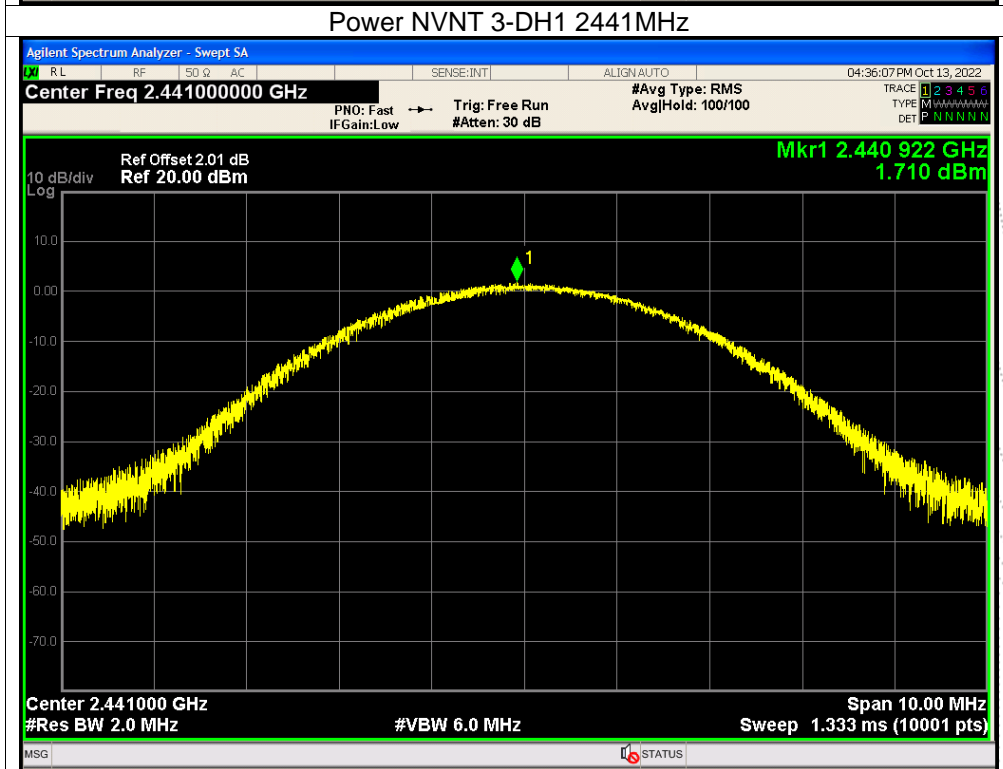
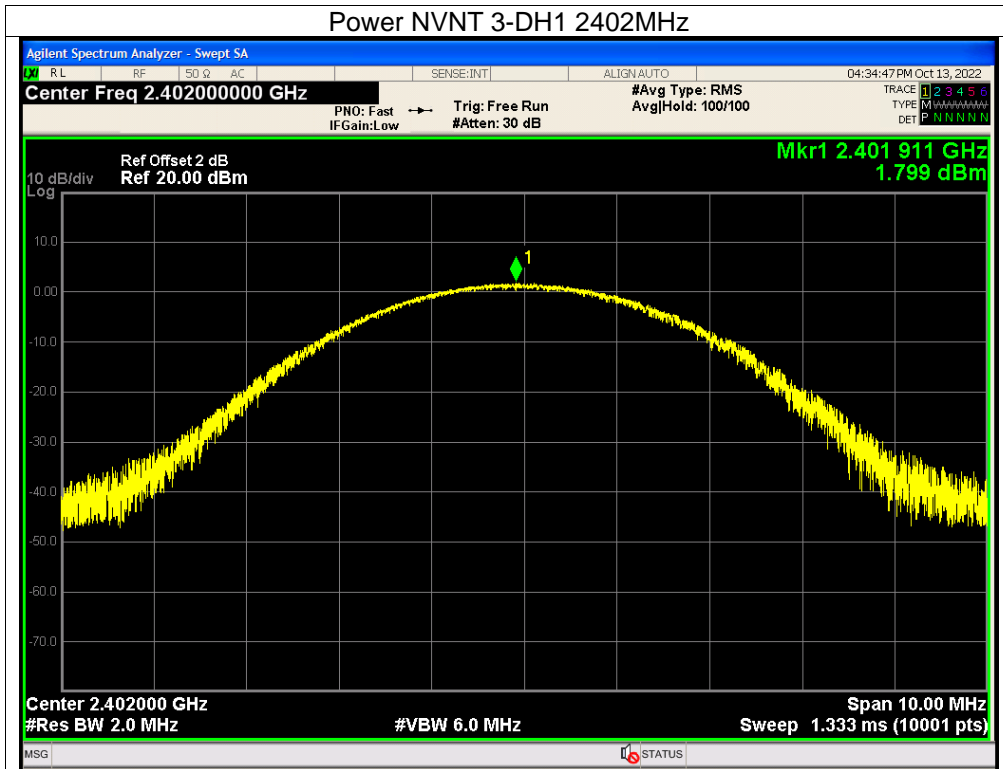

CHENZHEN

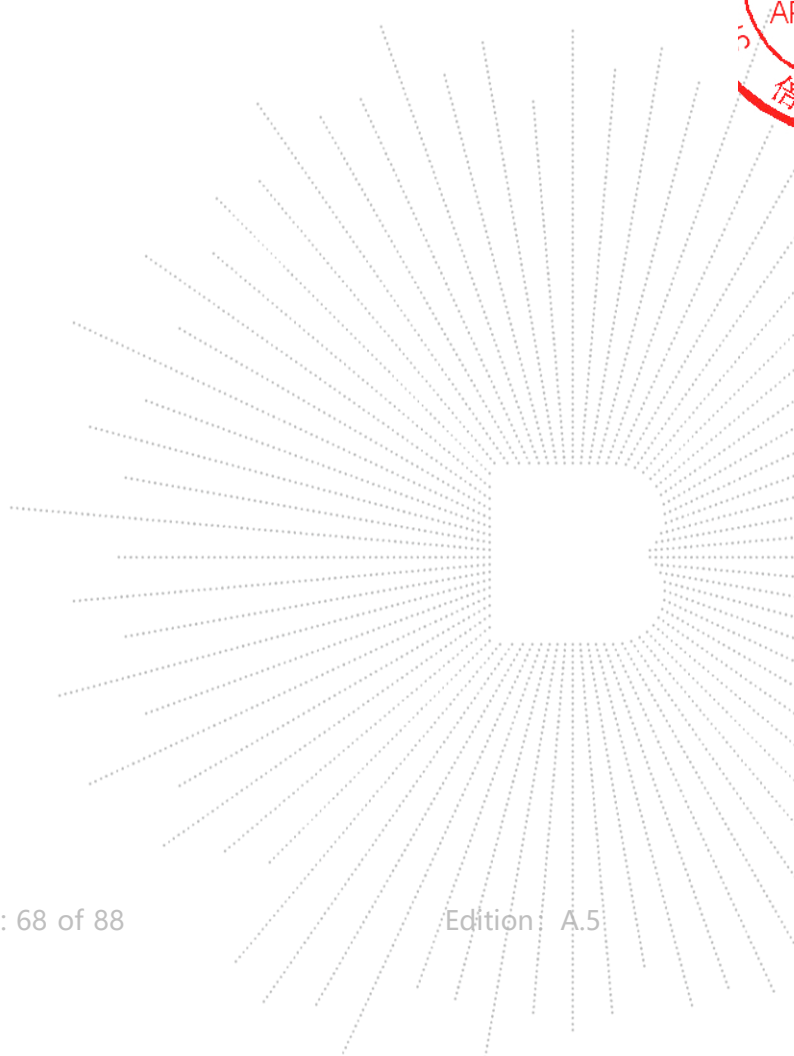
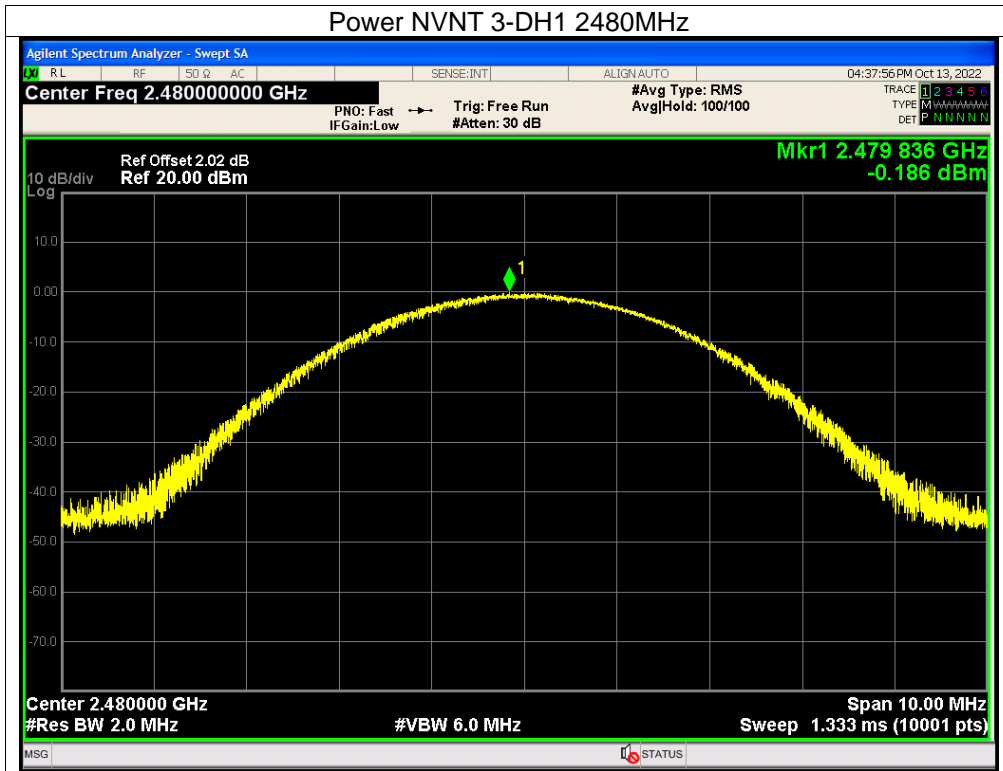

## 12. Hopping Channel Separation

### 12.1 Block Diagram Of Test Setup

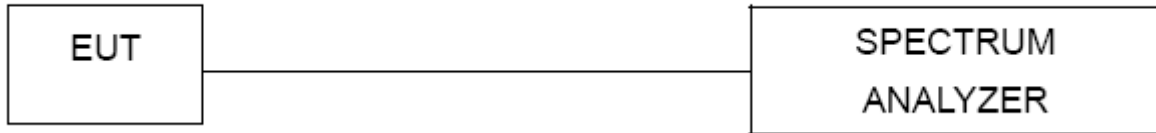

### 12.2 Limit

Frequency hopping systems shall have hopping channel carrier frequencies separated by a minimum of 25 kHz or the 20 dB bandwidth of the hopping channel, whichever is greater. Alternatively, frequency hopping systems operating in the 2400-2483.5 MHz band may have hopping channel carrier frequencies that are separated by 25 kHz or two-thirds of the 20 dB bandwidth of the hopping channel, whichever is greater, provided the systems operate with an output power no greater than 0.125W.

### 12.3 Test Procedure

1. Remove the antenna from the EUT and then connect a low RF cable from the antenna port to the spectrum.
2. Set the spectrum analyzer: RBW = 30kHz. VBW = 100kHz , Span = 2.0MHz. Sweep = auto; Detector Function = Peak. Trace = Max hold.
3. Allow the trace to stabilize. Use the marker-delta function to determine the separation between the peaks of the adjacent channels. The limit is specified in one of the subparagraphs of this Section Submit this plot.

### 12.4 Test Result

Condition	Mode	Hopping Freq1 (MHz)	Hopping Freq2 (MHz)	HFS (MHz)	Limit (MHz)	Verdict
NVNT	1-DH1	2401.99	2402.988	0.998	0.695	Pass
NVNT	1-DH1	2440.992	2441.99	0.998	0.689	Pass
NVNT	1-DH1	2478.994	2479.994	1	0.683	Pass
NVNT	2-DH1	2401.988	2402.99	1.002	0.904	Pass
NVNT	2-DH1	2440.994	2441.994	1	0.903	Pass
NVNT	2-DH1	2478.998	2479.998	1	0.902	Pass
NVNT	3-DH1	2401.986	2402.986	1	0.869	Pass
NVNT	3-DH1	2440.99	2441.994	1.004	0.867	Pass
NVNT	3-DH1	2478.996	2479.998	1.002	0.870	Pass

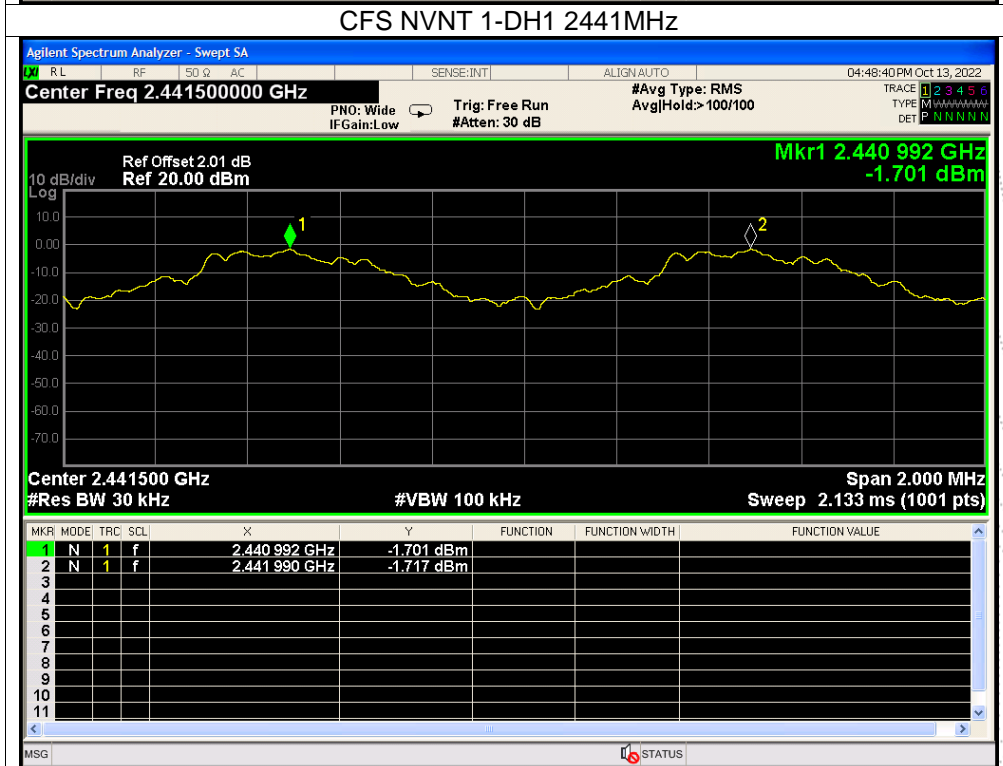
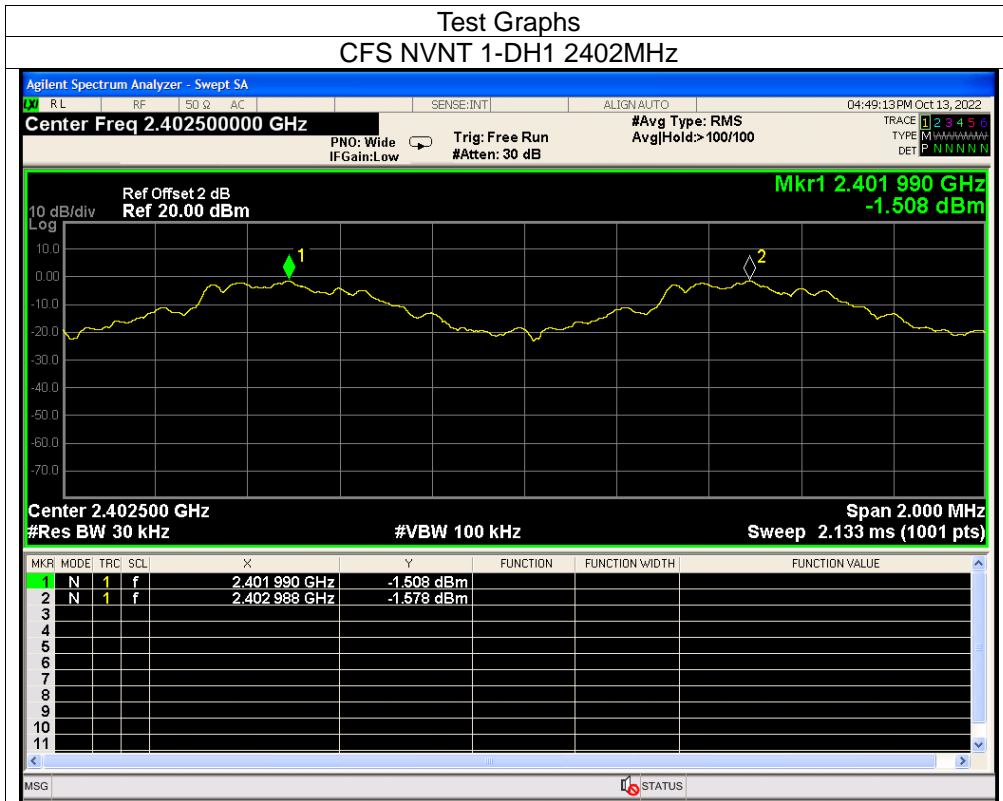

TEC  
 TO  
 OVE  
 檢

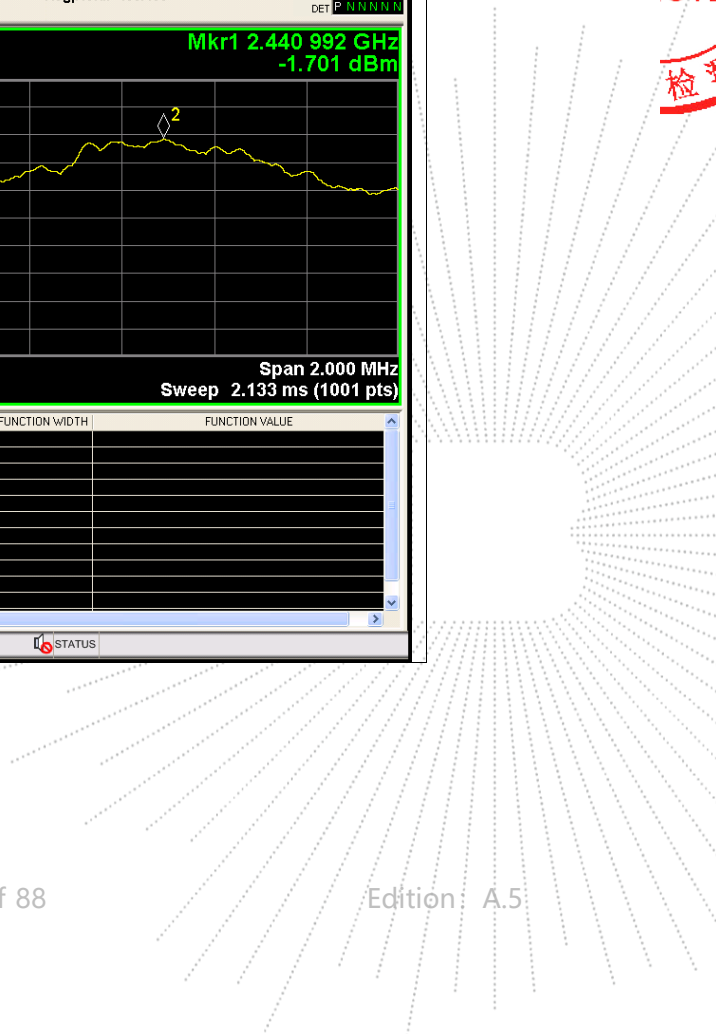

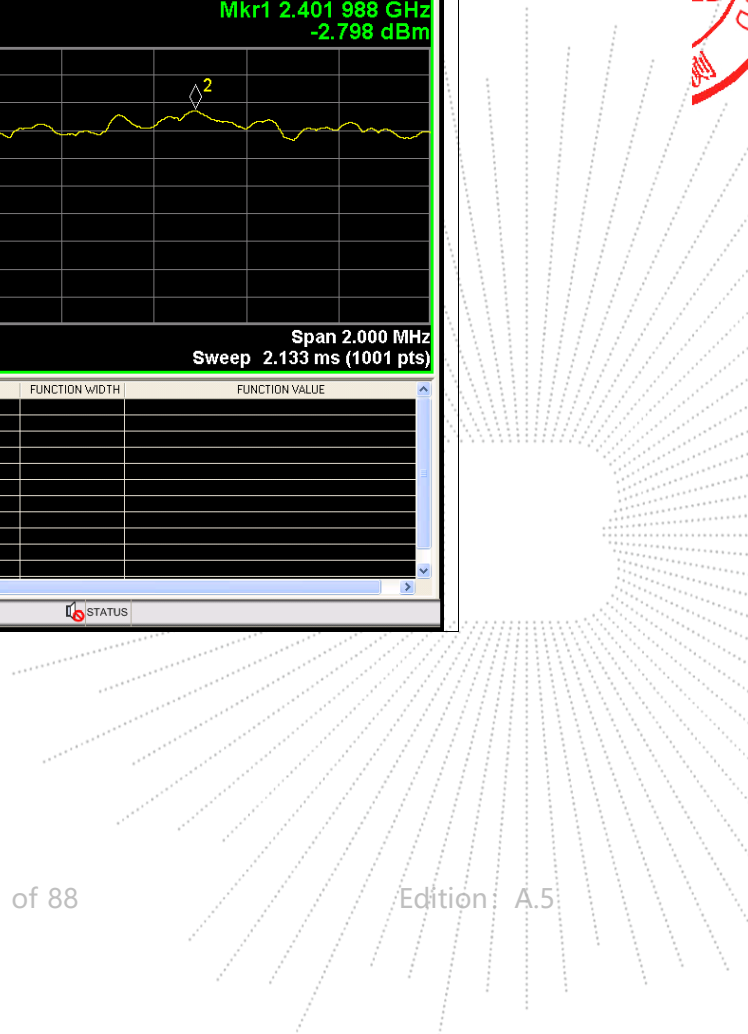
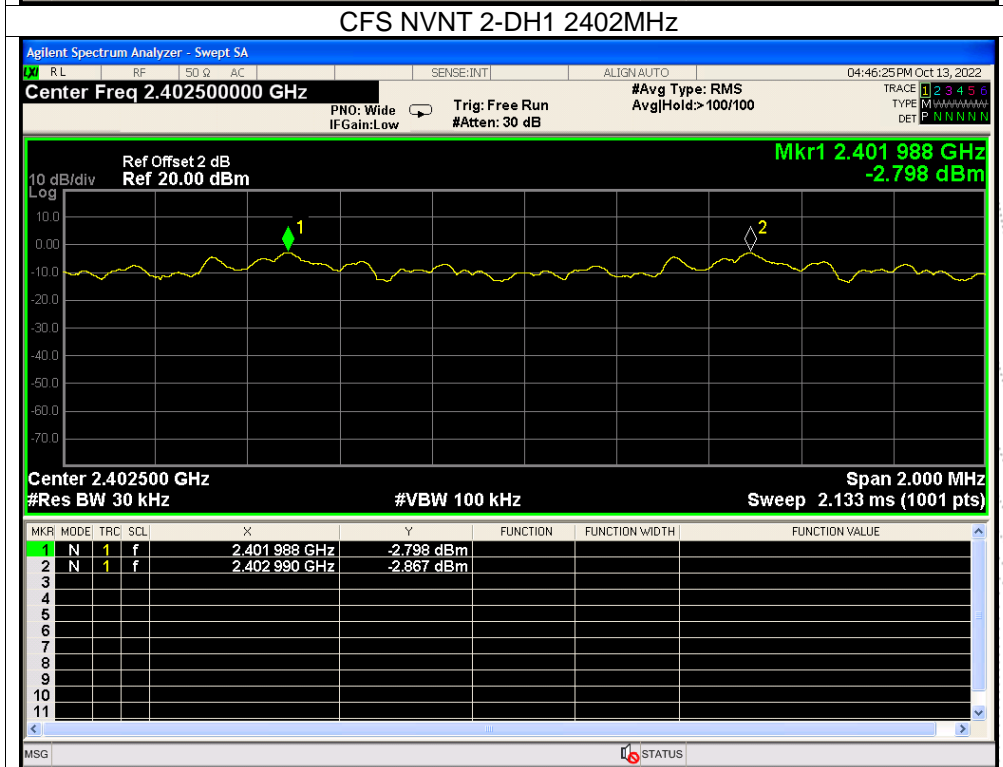
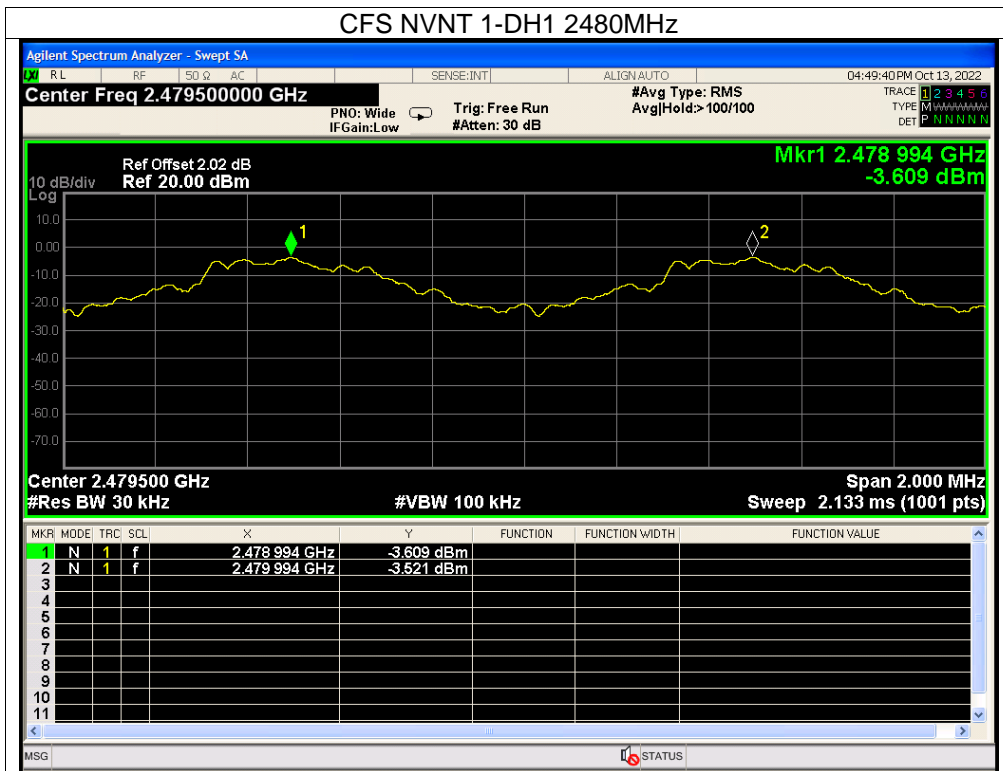

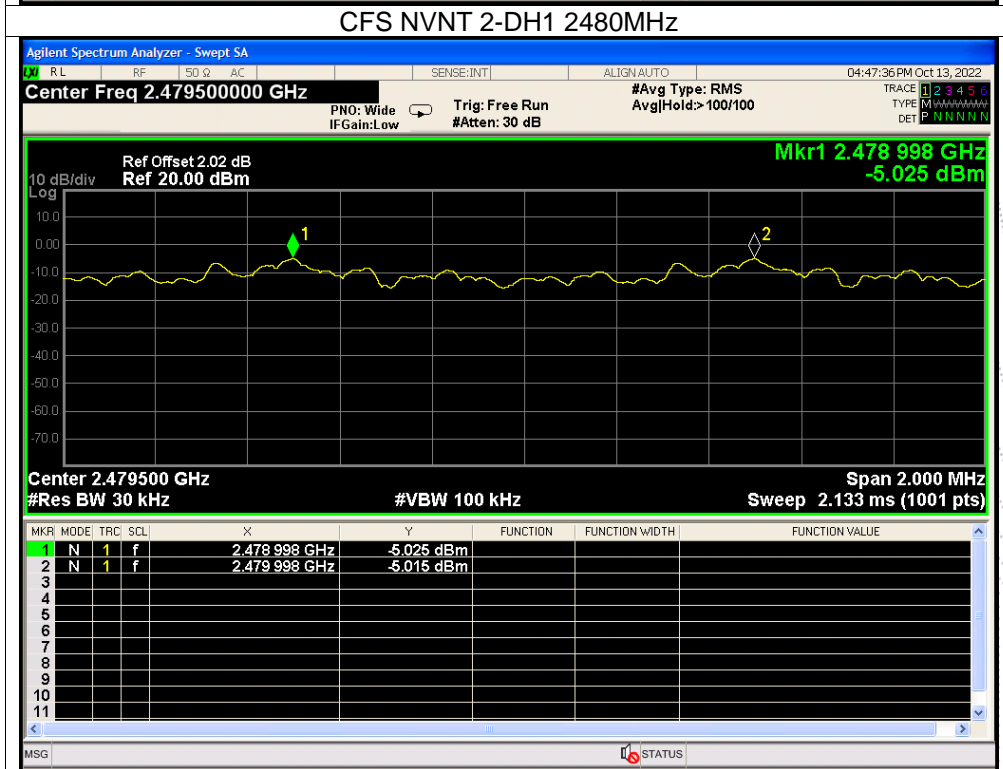
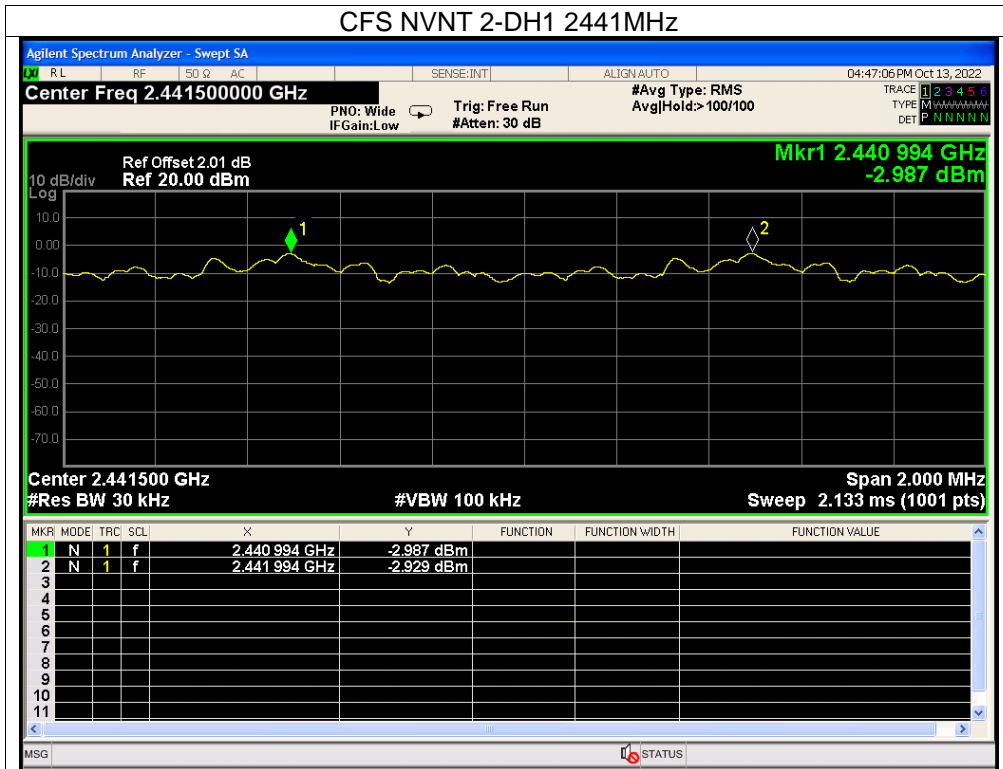

CO. LTD



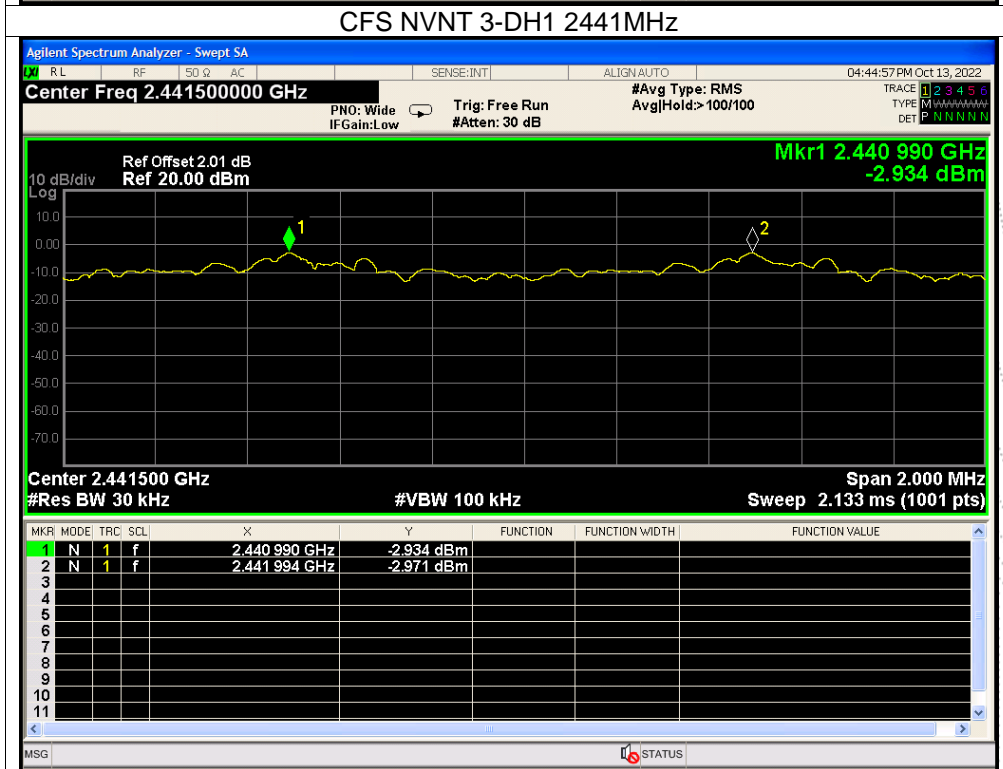
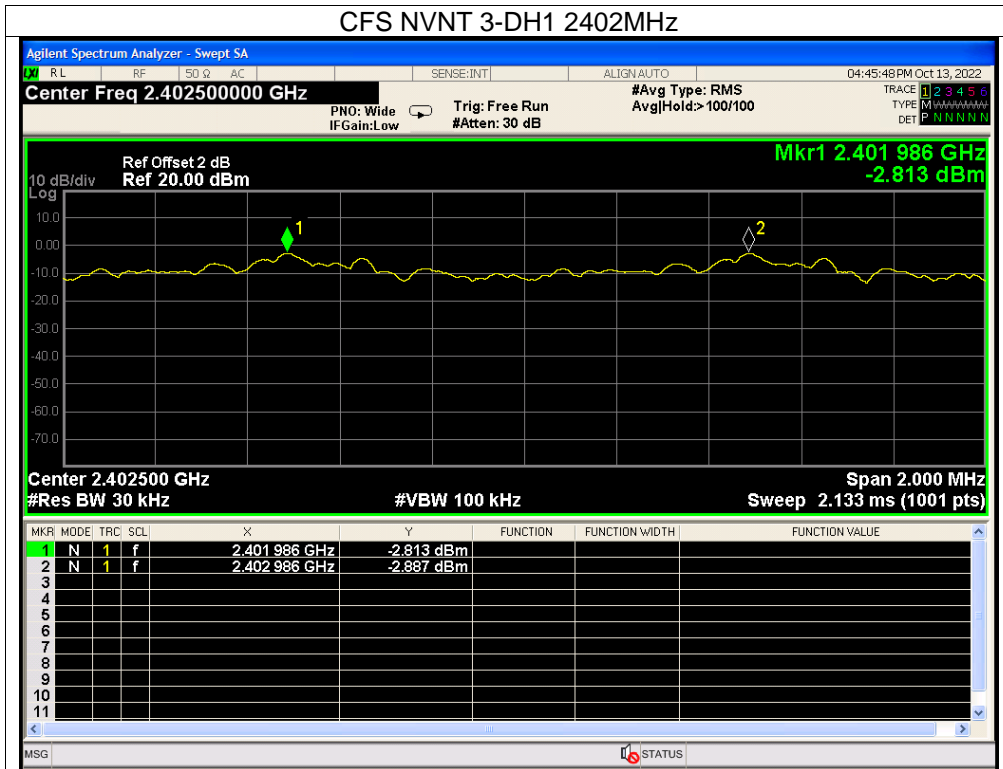

SHENZHEN

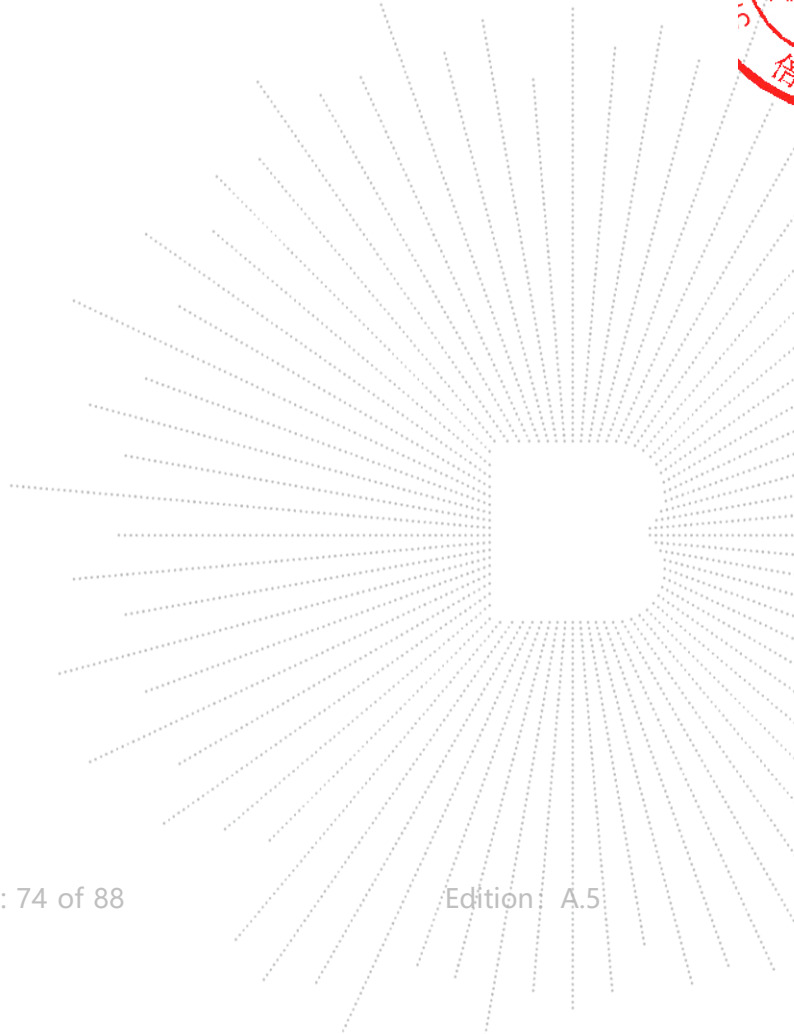
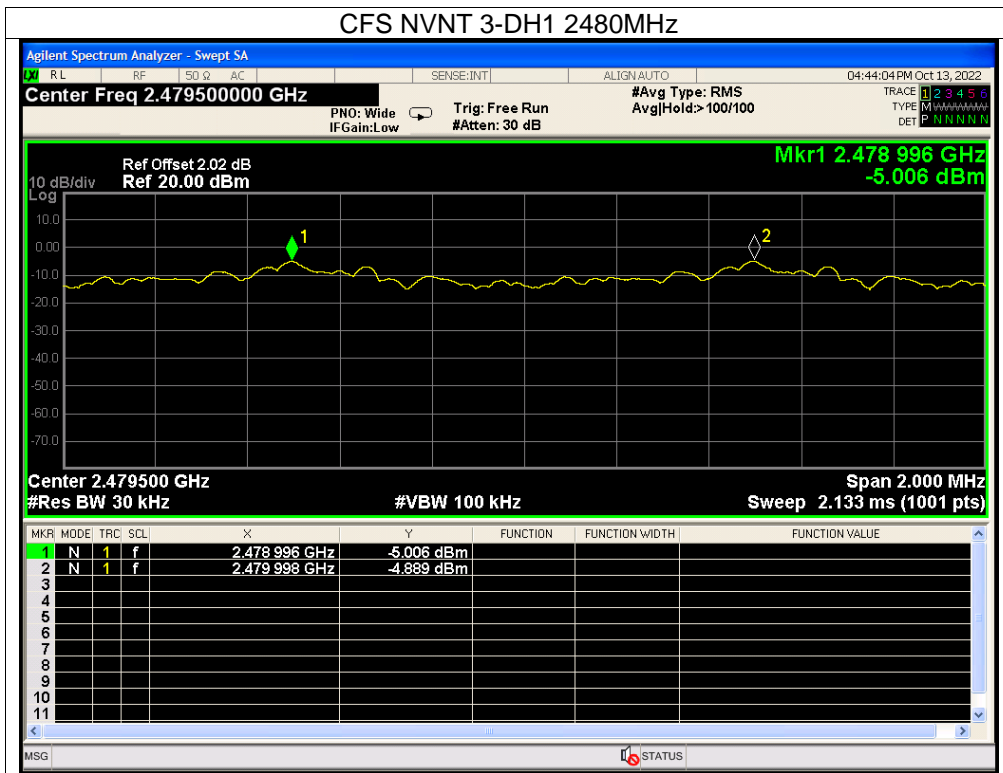

### 13. Number Of Hopping Frequency

#### 13.1 Block Diagram Of Test Setup



#### 13.2 Limit

Frequency hopping systems in the 2400-2483.5 MHz band shall use at least 15 channels.

#### 13.3 Test Procedure

1. Remove the antenna from the EUT and then connect a low RF cable from the antenna port to the spectrum.
2. Set the spectrum analyzer: RBW = 100kHz. VBW = 300kHz. Sweep = auto; Detector Function = Peak. Trace = Max hold.
3. Allow the trace to stabilize. It may prove necessary to break the span up to sections. in order to clearly show all of the hopping frequencies. The limit is specified in one of the subparagraphs of this Section.
4. Set the spectrum analyzer: Start Frequency = 2.4GHz, Stop Frequency = 2.4835GHz. Sweep=auto;

## 13.4 Test Result

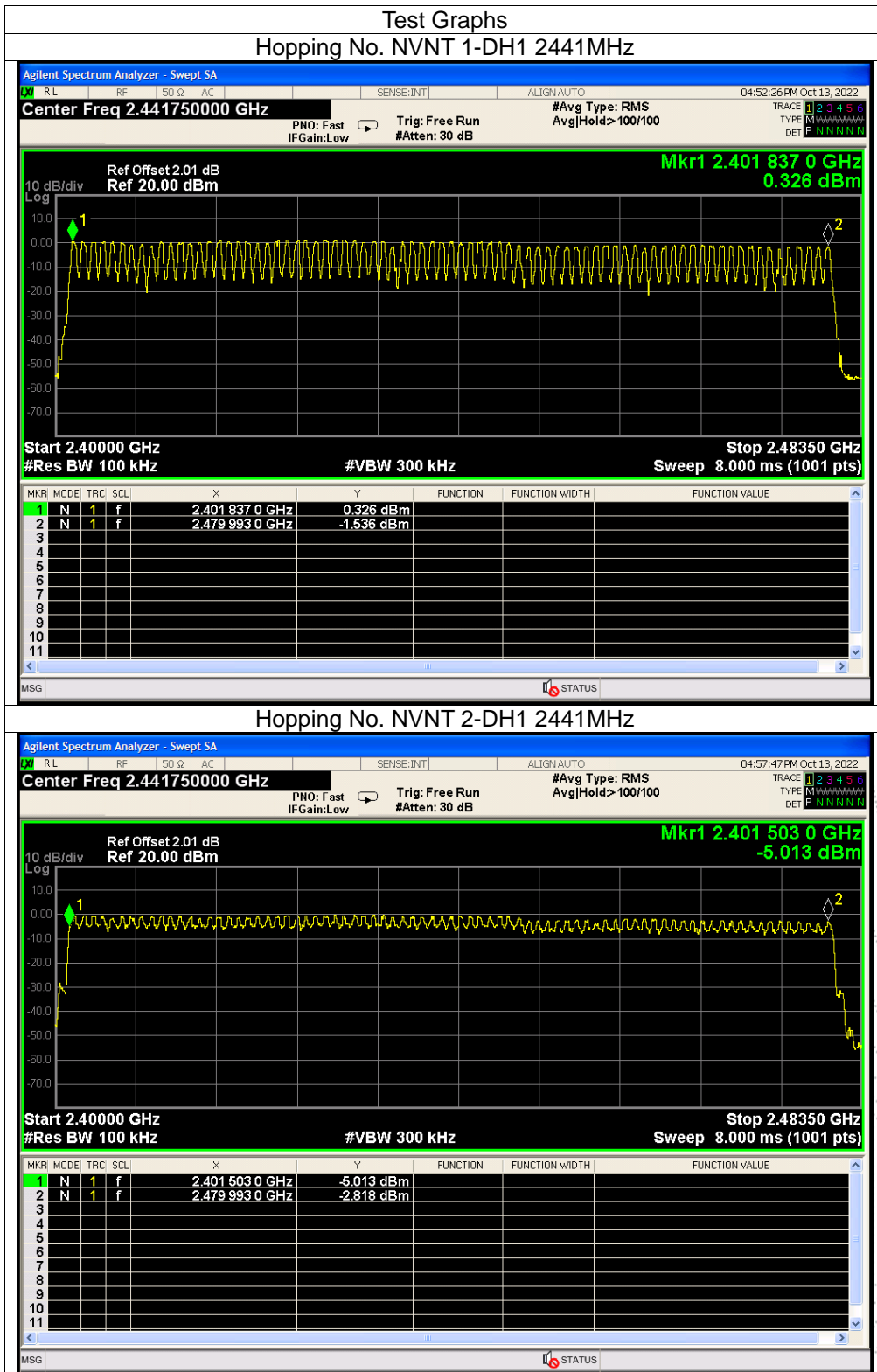

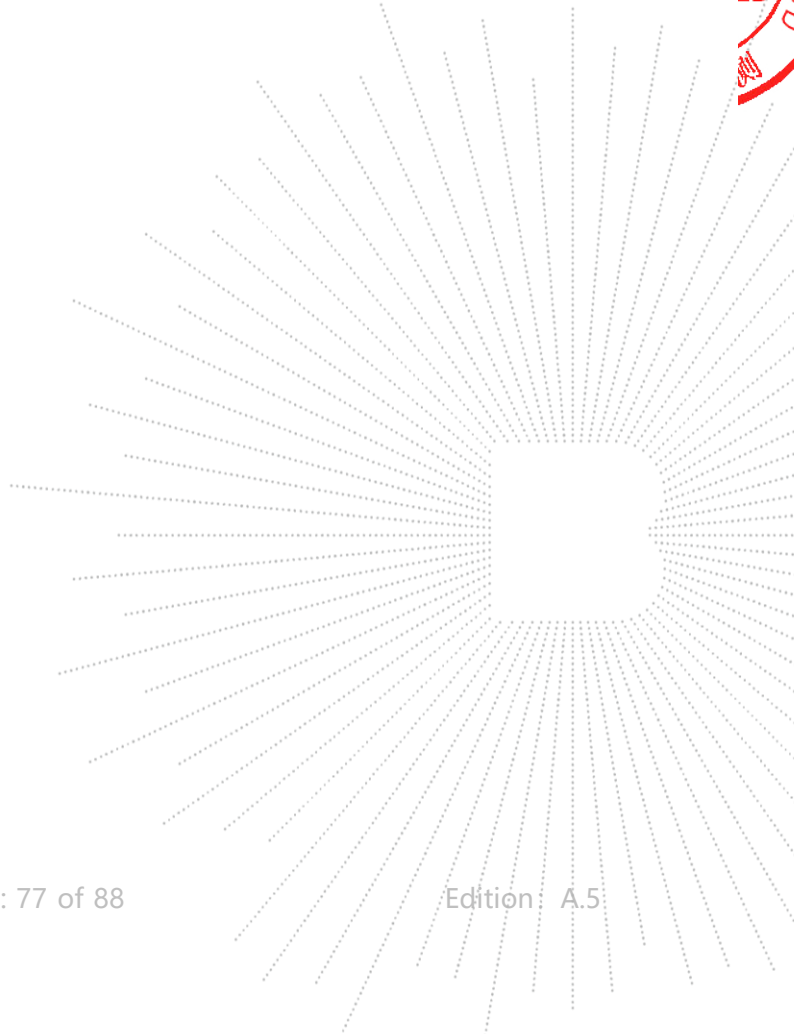
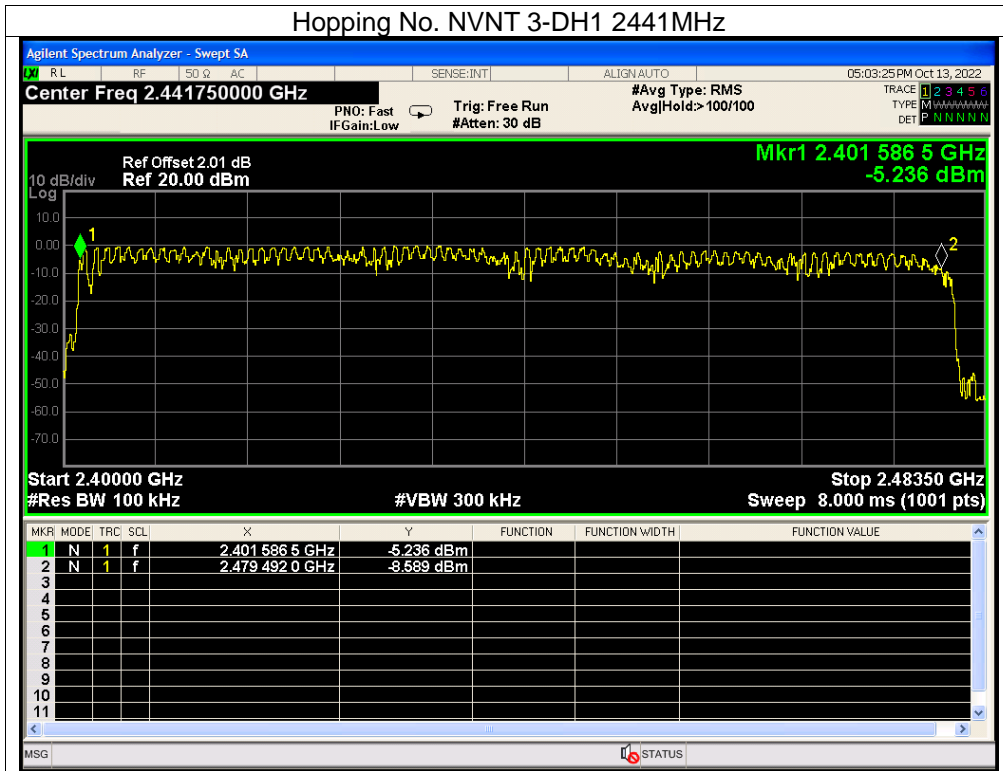

## 14. Dwell Time

### 14.1 Block Diagram Of Test Setup

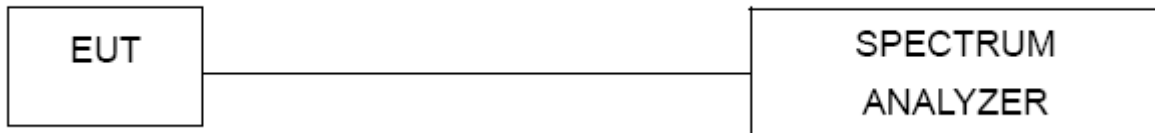

### 14.2 Limit

Frequency hopping systems in the 2400-2483.5 MHz band shall use at least 15 channels. The average time of occupancy on any channel shall not be greater than 0.4 seconds within a period of 0.4 seconds multiplied by the number of hopping channels employed. Frequency hopping systems may avoid or suppress transmissions on a particular hopping frequency provided that a minimum of 15 channels are used.

### 14.3 Test Procedure

1. Remove the antenna from the EUT and then connect a low RF cable from the antenna port to the spectrum.
2. Set spectrum analyzer span = 0. Centred on a hopping channel;
3. Set RBW = 1MHz and VBW = 3MHz. Sweep = as necessary to capture the entire dwell time per hopping channel. Set the EUT for DH5, DH3 and DH1 packet transmitting.
4. Use the marker-delta function to determine the dwell time. If this value varies with different modes of operation (e.g.. data rate. modulation format. etc.). repeat this test for each variation. The limit is specified in one of the subparagraphs of this Section. Submit this plot(s).

### 14.4 Test Result

DH5 Packet permit maximum 1600 / 79 / 6 hops per second in each channel  
(5 time slots RX, 1 time slot TX).

DH3 Packet permit maximum 1600 / 79 / 4 hops per second in each channel  
(3 time slots RX, 1 time slot TX).

DH1 Packet permit maximum 1600 / 79 / 2 hops per second in each channel  
(1 time slot RX, 1 time slot TX). So, the Dwell Time can be calculated as follows:

DH5:  $1600/79/6 \times 0.4 \times 79 \times (\text{MkrDelta})/1000$

DH3:  $1600/79/4 \times 0.4 \times 79 \times (\text{MkrDelta})/1000$

DH1:  $1600/79/2 \times 0.4 \times 79 \times (\text{MkrDelta})/1000$

Remark: Mkr Delta is once pulse time.

Condition	Mode	Frequency (MHz)	Pulse Time (ms)	Total Dwell Time (s)	Limit (s)	Verdict
NVNT	1-DH1	2441	0.384	0.123	0.4	Pass
NVNT	1-DH3	2441	1.639	0.262	0.4	Pass
NVNT	1-DH5	2441	2.888	0.308	0.4	Pass
NVNT	2-DH1	2441	0.389	0.124	0.4	Pass
NVNT	2-DH3	2441	1.641	0.263	0.4	Pass
NVNT	2-DH5	2441	2.889	0.308	0.4	Pass
NVNT	3-DH1	2441	0.389	0.124	0.4	Pass
NVNT	3-DH3	2441	1.64	0.262	0.4	Pass
NVNT	3-DH5	2441	2.891	0.308	0.4	Pass

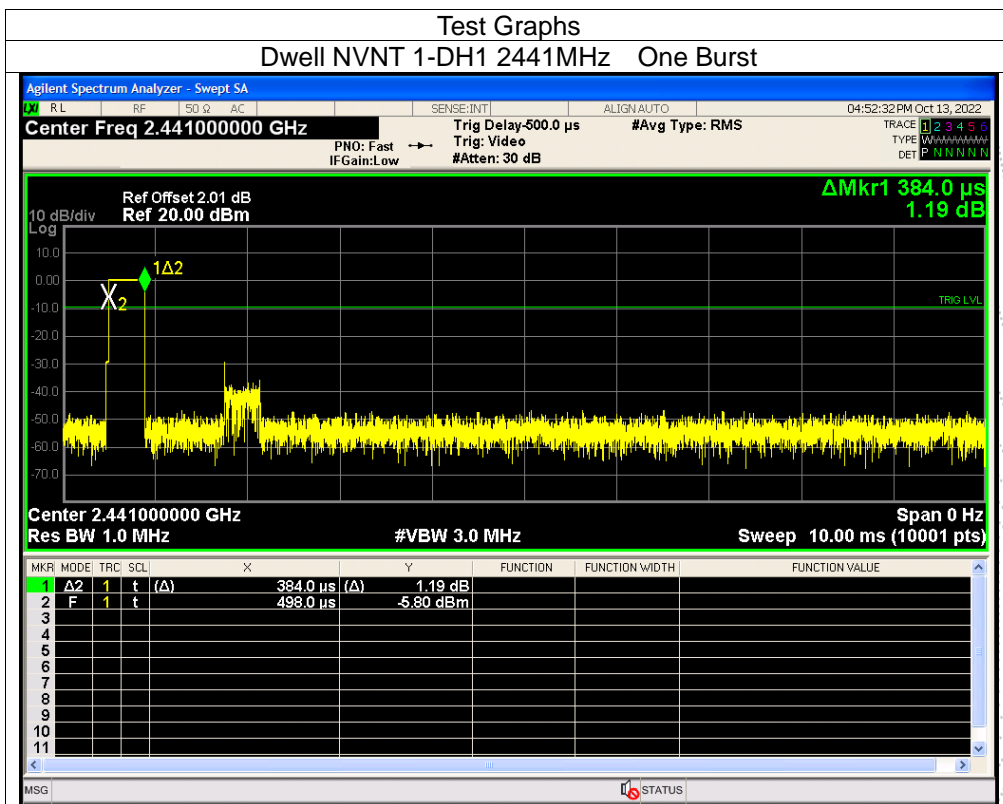

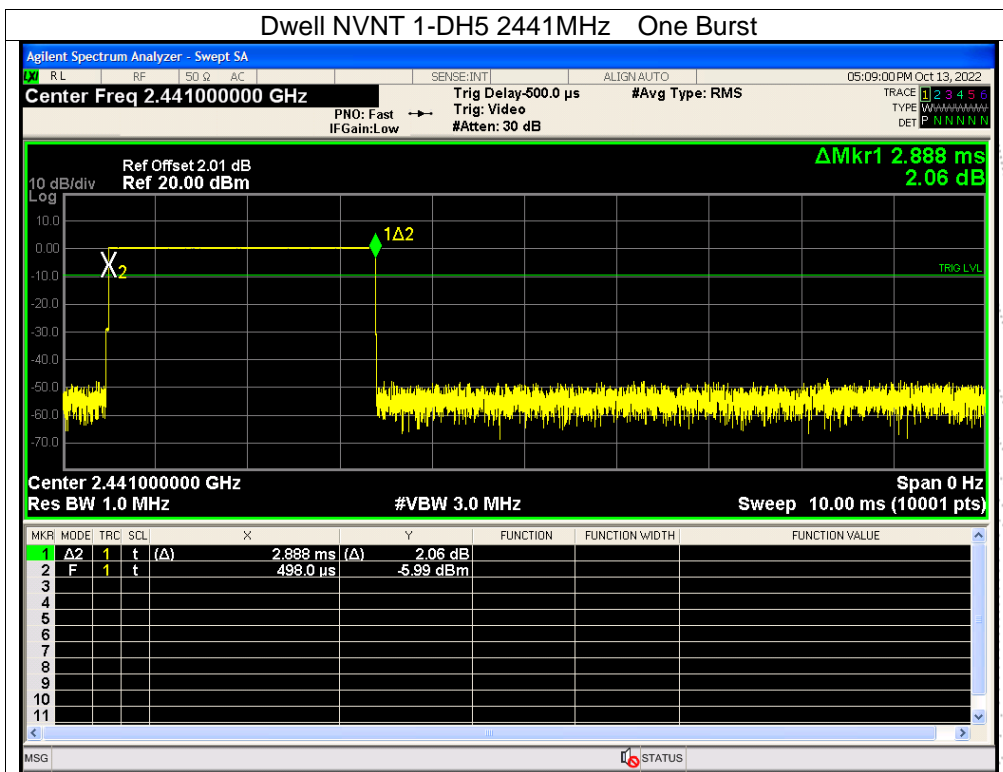
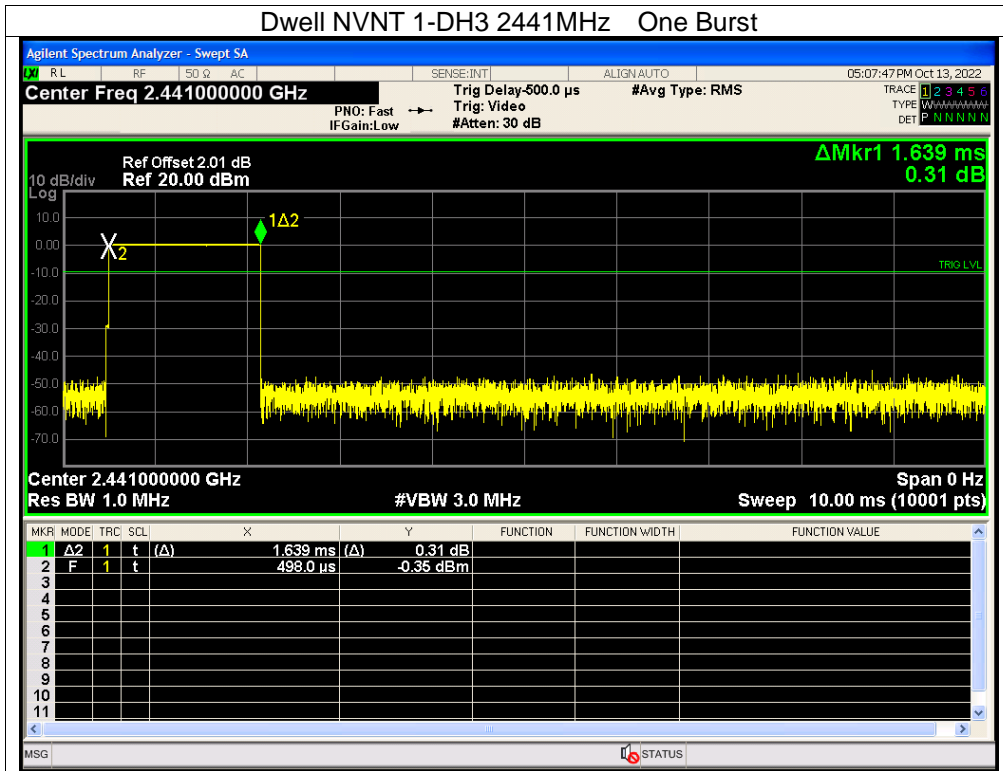



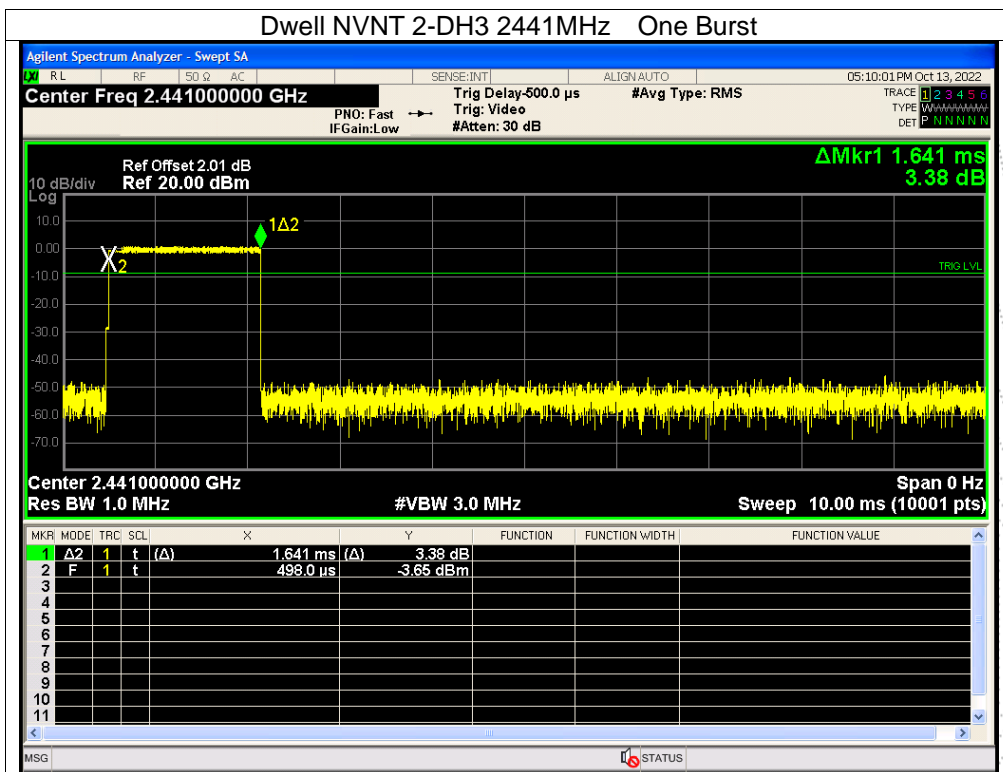
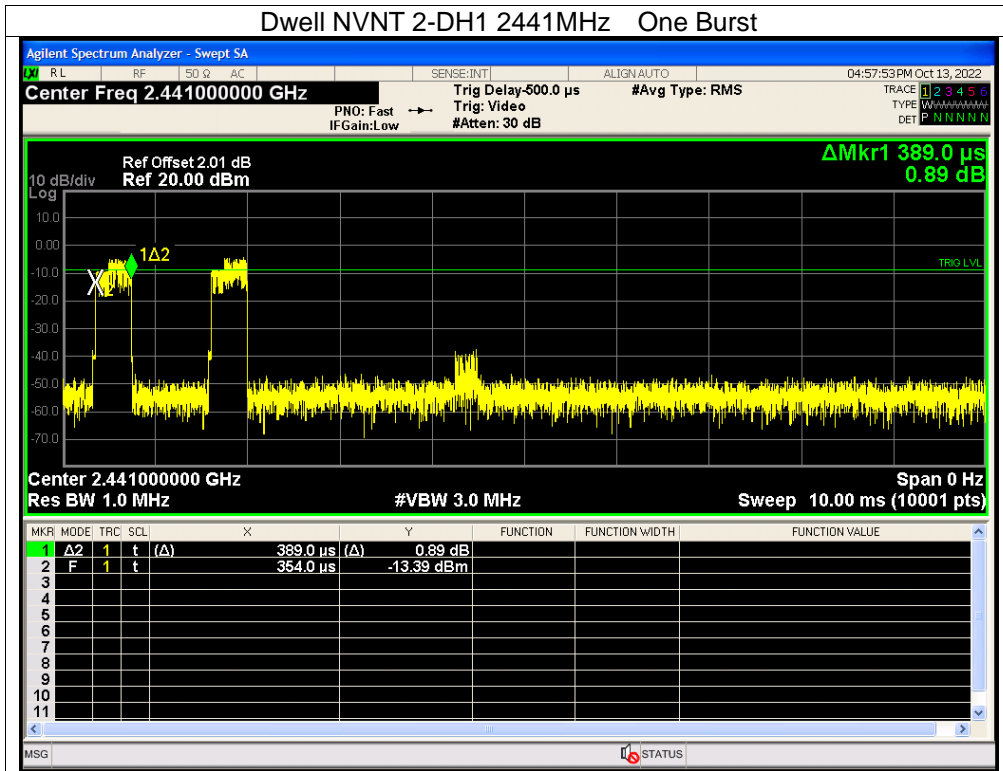

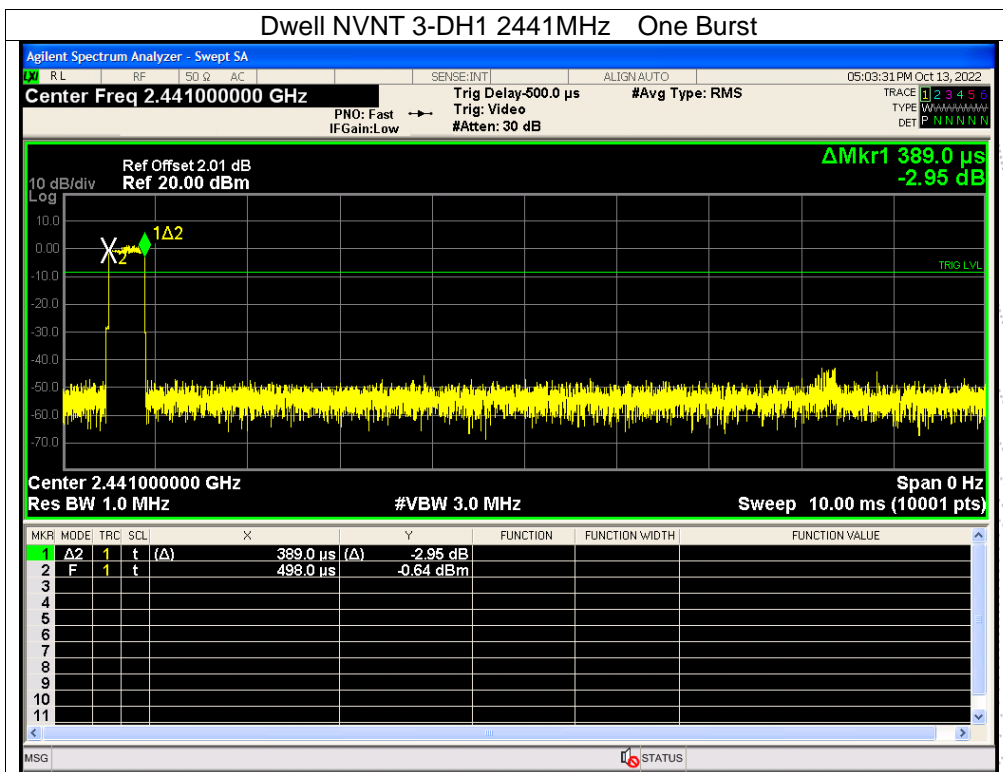
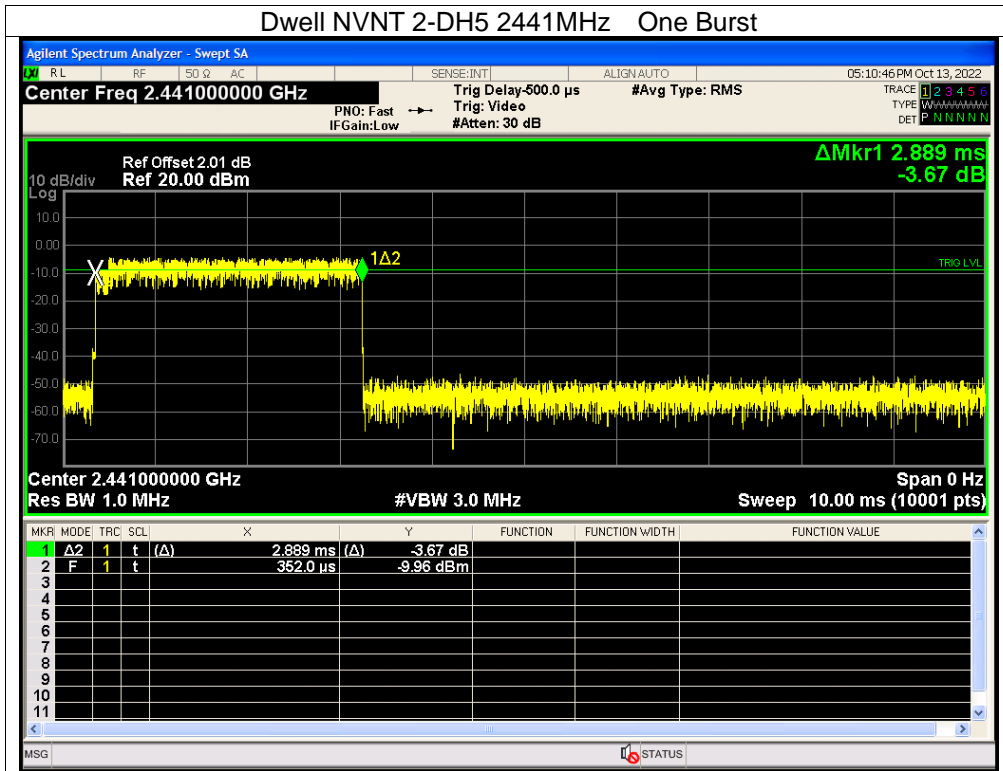
 BCTC  
 3C  
 PPR  
 检测

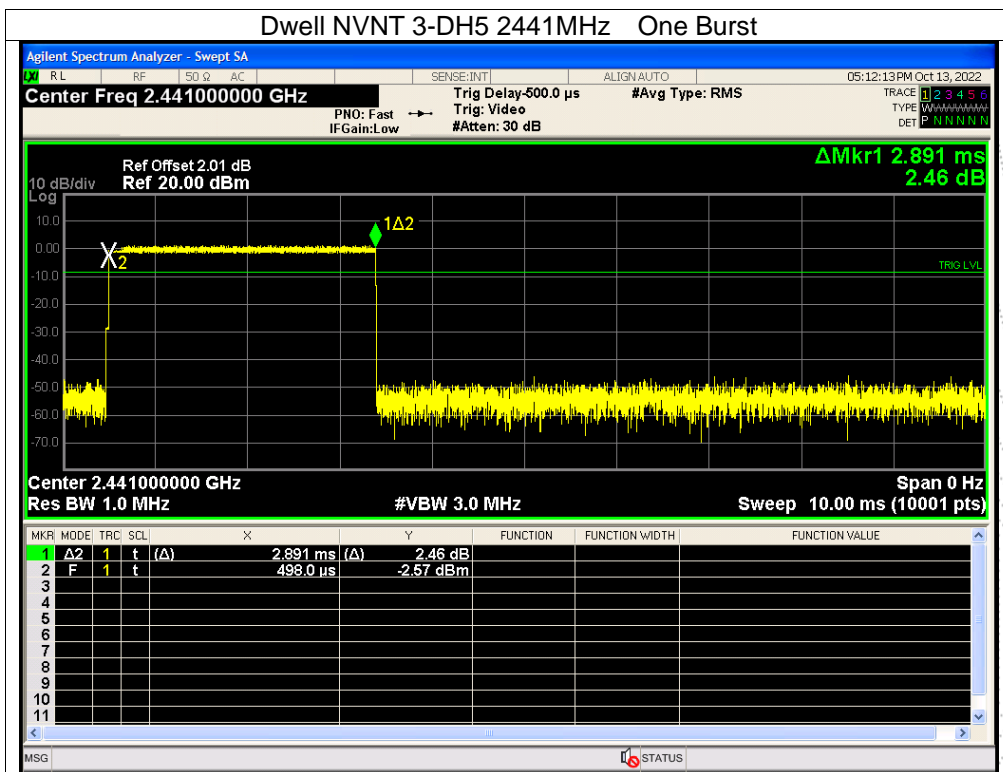
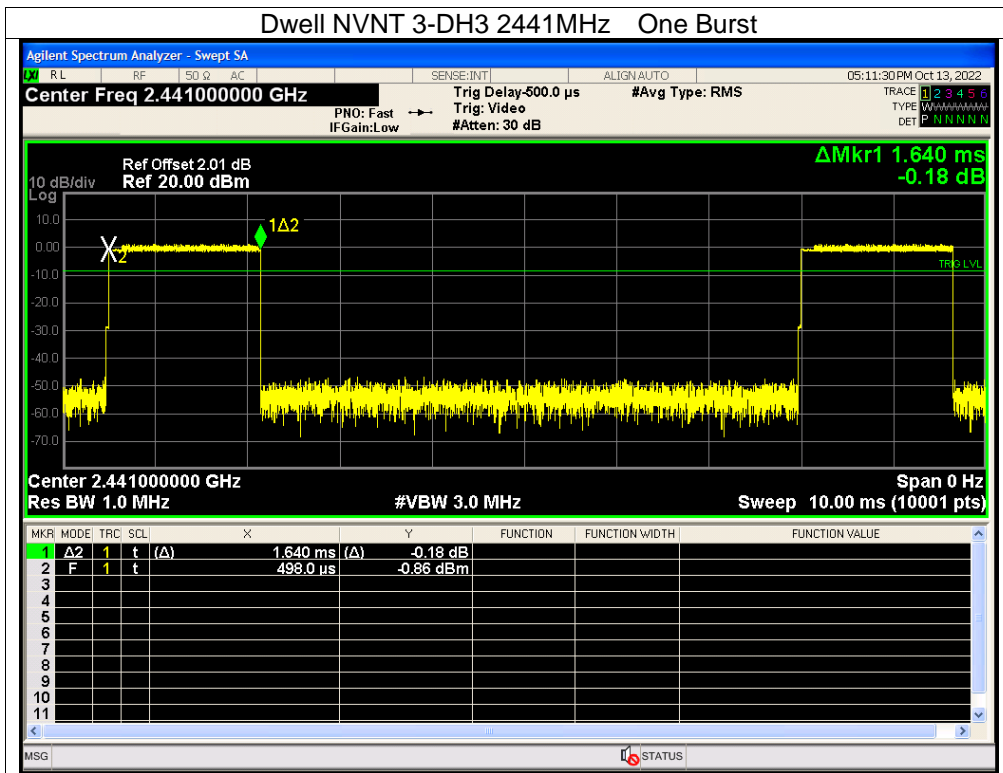



## 15. Antenna Requirement

### 15.1 Limit

According to RSS-Gen issue 5, section 8.3, a transmitter can only be sold or operated with antennas with which it was certified. A transmitter may be certified with multiple antenna types. An antenna type comprises antennas having similar in-band and out-of-band radiation patterns.

### 15.2 Test Result

The EUT antenna is Chip antenna, fulfill the requirement of this section.

### 16. EUT Photographs

EUT Photo 1

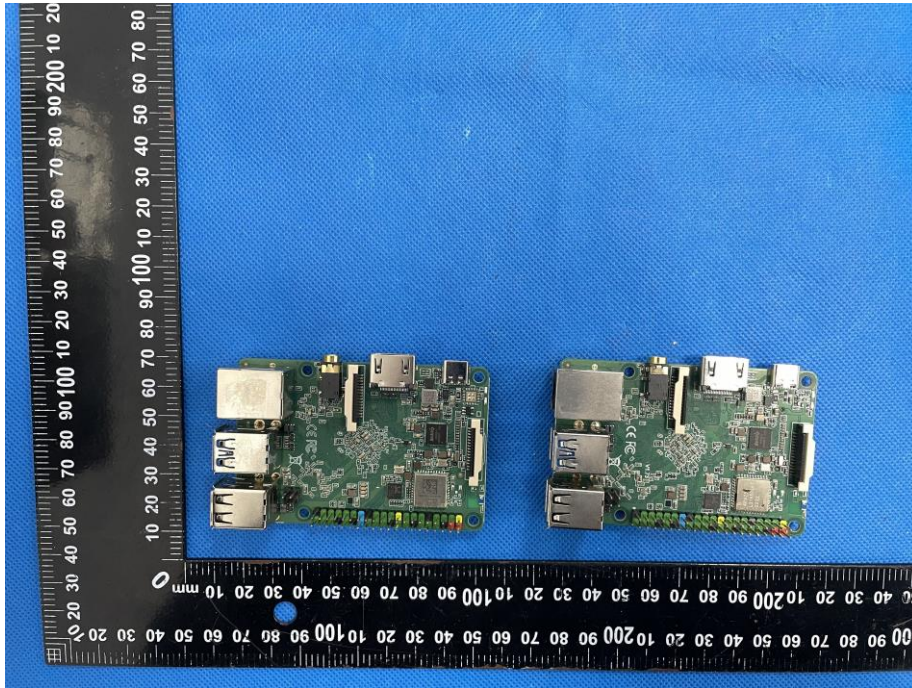

EUT Photo 2

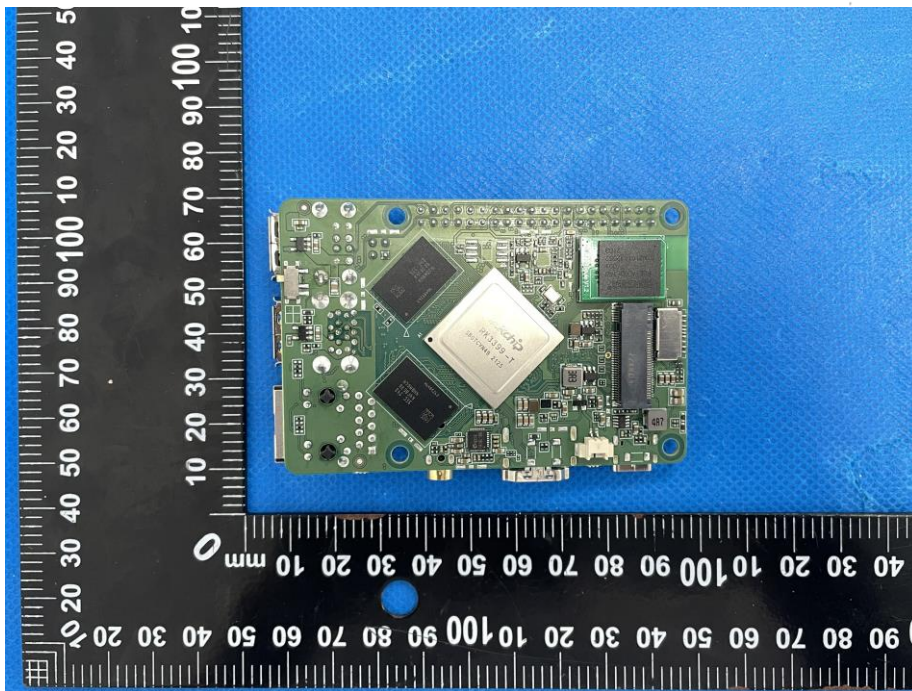

### 17. EUT Test Setup Photographs

#### Conducted Emissions Photo



#### Radiated Measurement Photos



BCTC  
BC  
APPR  
停测

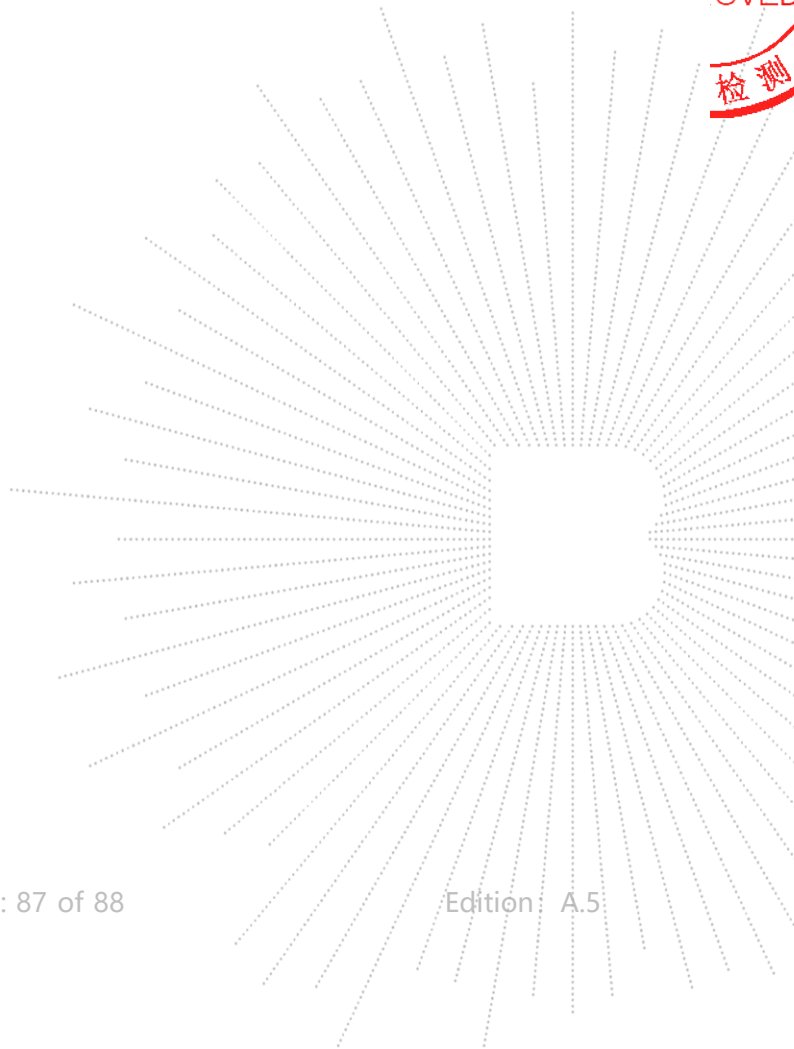
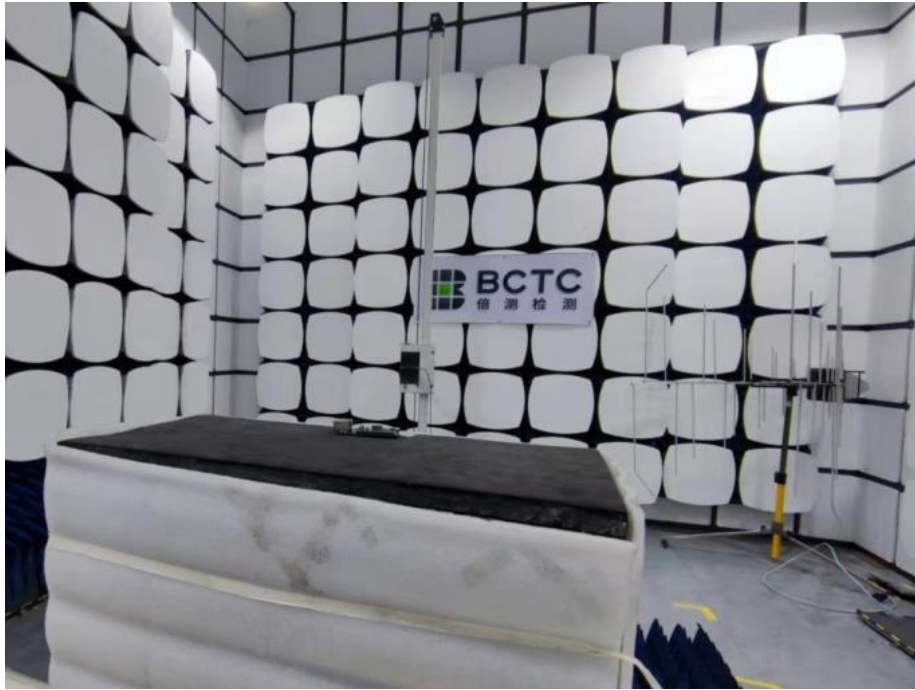

## STATEMENT

1. The equipment lists are traceable to the national reference standards.
2. The test report can not be partially copied unless prior written approval is issued from our lab.
3. The test report is invalid without the "special seal for inspection and testing".
4. The test report is invalid without the signature of the approver.
5. The test process and test result is only related to the Unit Under Test.
6. Sample information is provided by the client and the laboratory is not responsible for its authenticity.
7. The test report without CMA mark is only used for scientific research, teaching, enterprise product development and internal quality control purposes.
8. The quality system of our laboratory is in accordance with ISO/IEC17025.
9. If there is any objection to this test report, the client should inform issuing laboratory within 15 days from the date of receiving test report.

Address:

1-2/F., Building B, Pengzhou Industrial Park, No.158, Fuyuan 1st Road, Zhancheng, Fuhai Subdistrict, Bao'an District, Shenzhen, Guangdong, China

TEL: 400-788-9558

P.C.: 518103

FAX: 0755-33229357

Website: <http://www.chnbctc.com>

E-Mail: [bctc@bctc-lab.com.cn](mailto:bctc@bctc-lab.com.cn)

\*\*\*\*\* END \*\*\*\*\*

