

TEST REPORT

Report No.: BCTC2207596553-5E

Applicant: ROCKPI TRADING LIMITED

Product Name: ROCK Pi 4/ROCK 4

Model/Type reference: ROCK 4C Plus

Tested Date: 2022-07-19 to 2022-07-26

Issued Date: 2022-07-27

Shenzhen BCTC Testing Co., Ltd.



Product Name: ROCK Pi 4/ROCK 4
Trademark: N/A
Model/Type reference: ROCK 4C Plus
ROCK Pi 4C Plus, ROCK Pi 4C Pro, ROCK Pi 4C Max, ROCK 4C, ROCK 4C Plus,
ROCK 4C Pro, ROCK 4C Max
Prepared For: ROCKPI TRADING LIMITED
Address: Room 11, 27 / f, Ga wah international centre, 191 Javaroad, north point, Hong Kong
Manufacturer: ROCKPI TRADING LIMITED
Address: Room 11, 27 / f, Ga wah international centre, 191 Javaroad, north point, Hong Kong
Prepared By: Shenzhen BCTC Testing Co., Ltd.
Address: 1-2/F., Building B, Pengzhou Industrial Park, No.158, Fuyuan 1st Road,
Zhancheng, Fuhai Subdistrict, Bao'an District, Shenzhen, Guangdong, China
Sample Received Date: 2022-07-19
Sample tested Date: 2022-07-19 to 2022-07-26
Issue Date: 2022-07-27
Report No.: BCTC2207596553-5E
Test Standards: ETSI EN 300 328 V2.2.2 (2019-07)
Test Results: PASS
Remark: This is WIFI-2.4GHz band radio test report.

Tested by:

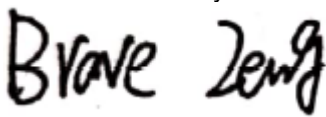

Brave Zeng/ Project Handler

Approved by:



Zero Zhou/Reviewer

The test report is effective only with both signature and specialized stamp. This result(s) shown in this report refer only to the sample(s) tested. Without written approval of Shenzhen BCTC Testing Co., Ltd, this report can't be reproduced except in full. The tested sample(s) and the sample information are provided by the client.

Table Of Content

	Page
Test Report Declaration	
1. Version	5
2. Test Summary	6
3. Measurement Uncertainty	7
4. Product Information And Test Setup	8
4.1 Product Information	8
4.2 Test Setup Configuration	8
4.3 Support Equipment	8
4.4 Channel List	9
4.5 Test Mode	9
4.6 Test Environment	9
5. Test Facility And Test Instrument Used	10
5.1 Test Facility	10
5.2 Test Instrument Used	10
6. Information As Required	11
7. RF Output Power	14
7.1 Block Diagram Of Test Setup	14
7.2 Limit	14
7.3 Test procedure	14
7.4 Test Result	16
8. Power Spectral Density	22
8.1 Block Diagram Of Test Setup	22
8.2 Limit	22
8.3 Test procedure	22
8.4 Test Result	23
9. Adaptivity	29
9.1 Block Diagram Of Test Setup	29
9.2 Limit	29
9.3 Test procedure	29
9.4 Test Result	30
10. Occupied Channel Bandwidth	31
10.1 Block Diagram Of Test Setup	31
10.2 Limit	31
10.3 Test procedure	31
10.4 Test Result	32
11. Transmitter Unwanted Emissions In The Out-Of-Band Domain	36
11.1 Block Diagram Of Test Setup	36
11.2 Limit	36
11.3 Test procedure	36
11.4 Test Result	38
12. Transmitter Unwanted Emissions In The Spurious Domain	41
12.1 Block Diagram Of Test Setup	41
12.2 Limits	42
12.3 Test Procedure	42
12.4 Test Results	43
13. Receiver Spurious Emissions	44

13.1	Block Diagram Of Test Setup.....	44
13.2	Limits.....	45
13.3	Test Procedure	45
13.4	Test Results	46
14.	Receiver Blocking.....	47
14.1	Block Diagram Of Test Setup.....	47
14.2	Limit	47
14.3	Test procedure.....	48
14.4	Test Result.....	48
15.	EUT Photographs.....	49
16.	EUT Test Setup Photographs.....	57

(Note: N/A Means Not Applicable)

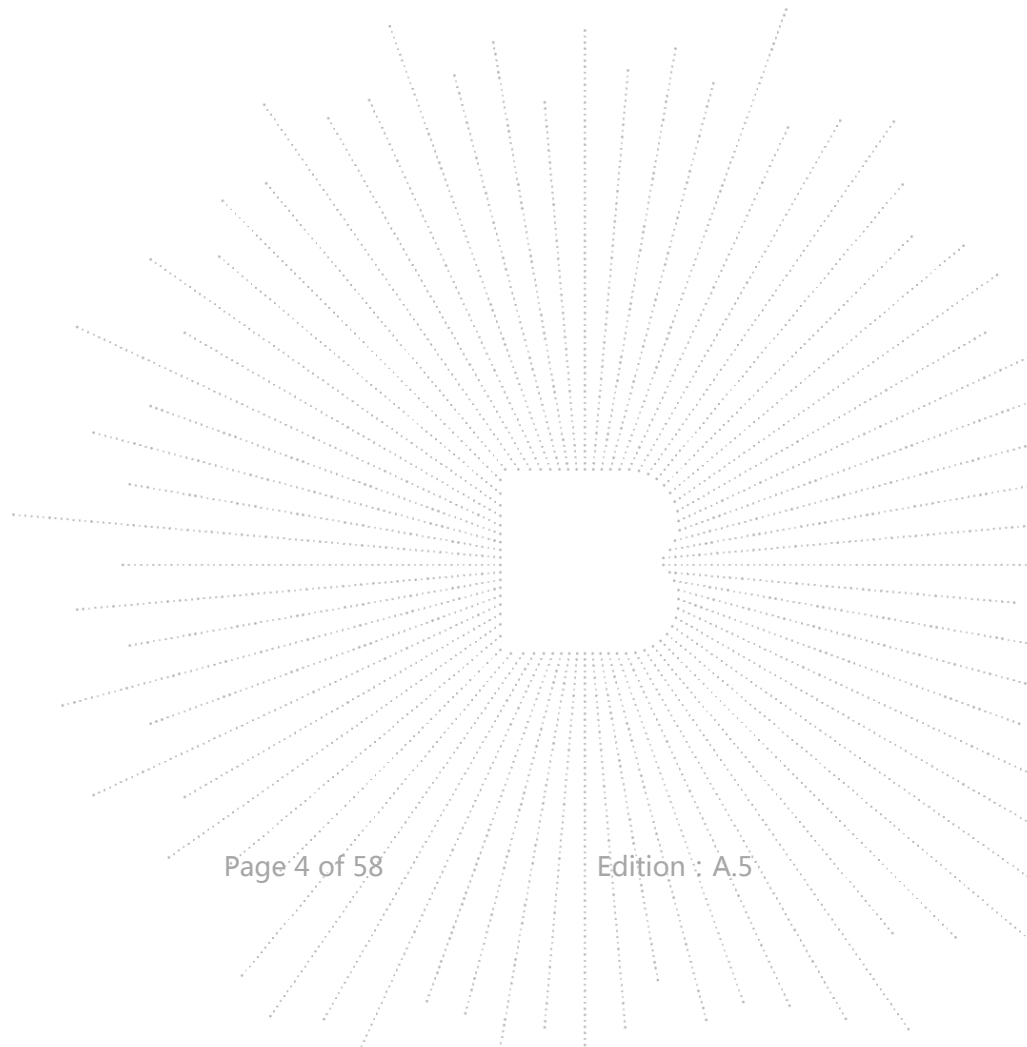

1. Version

Report No.	Issue Date	Description	Approved
BCTC2207596553-5E	2022-07-27	Original	Valid

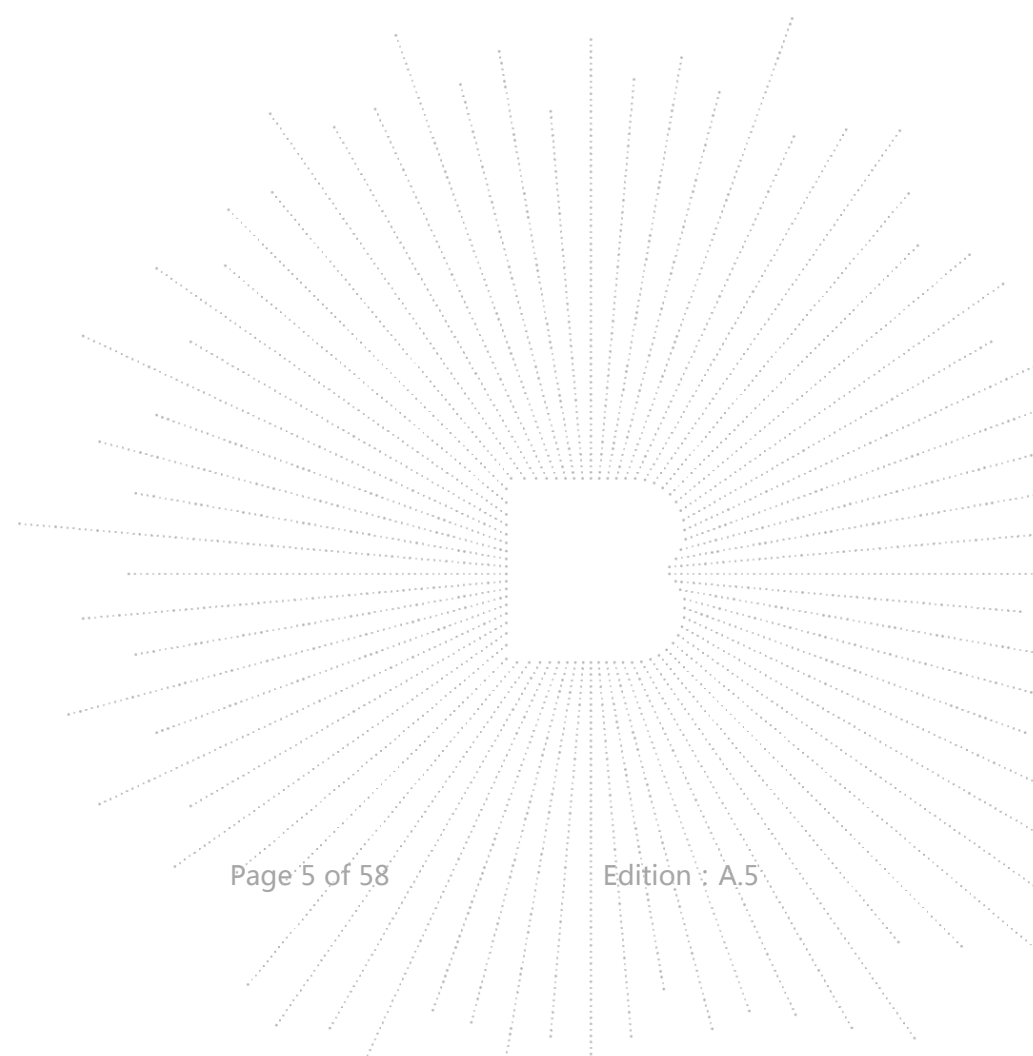

2. Test Summary

The Product has been tested according to the following specifications:

No.	Test Parameter	Clause No.	Results
Transmitter Parameters			
1	RF output power	4.3.2.2	PASS
2	Power Spectral Density	4.3.2.3	PASS
3	Duty Cycle, Tx-sequence, Tx-gap	4.3.2.4	N/A
4	Medium Utilisation (MU) factor	4.3.2.5	N/A
5	Adaptivity (adaptive equipment using modulations other than FHSS)	4.3.2.6	PASS
6	Occupied Channel Bandwidth	4.3.2.7	PASS
7	Transmitter unwanted emissions in the out-of-band domain	4.3.2.8	PASS
8	Transmitter unwanted emissions in the spurious domain	4.3.2.9	PASS
Receiver Parameters			
9	Receiver spurious emissions	4.3.2.10	PASS
10	Receiver Blocking	4.3.2.11	PASS
11	Geo-location Capability	4.3.2.12	N/A

Remark:

N/A is an abbreviation for Not Applicable and means this test item is not applicable for this device according to the technology characteristic of device.

3. Measurement Uncertainty

Where relevant, the following measurement uncertainty levels have been estimated for tests performed on the Product as specified in CISPR 16-4-2. This uncertainty represents an expanded uncertainty expressed at approximately the 95% confidence level using a coverage factor of k=2.

RF frequency	1×10^{-7}
RF power, conducted	± 1.0 dB
Conducted spurious emission (30MHz-1GHz)	1.28 dB
Conducted spurious emission (1GHz-18GHz)	1.576 dB
Radiated Spurious emission (30MHz-1GHz)	4.30 dB
Radiated Spurious emission (1GHz-18GHz)	4.5 dB
Temperature	0.59 °C
Humidity	5.3 %

4. Product Information And Test Setup

4.1 Product Information

Model/Type reference:	ROCK 4C Plus ROCK Pi 4C Plus, ROCK Pi 4C Pro, ROCK Pi 4C Max, ROCK 4C, ROCK 4C Plus, ROCK 4C Pro, ROCK 4C Max
Model differences:	All the model are the same circuit and RF module, except model names.
Hardware Version:	N/A
Software Version:	N/A
Operation Frequency:	WiFi (2.4G): IEEE 802.11b/g/n HT20: 2412-2472MHz
Max. RF output power:	WiFi (2.4G): 13.24 dBm
Type of Modulation:	WiFi: DSSS, OFDM
Antenna installation:	FPC antenna
Antenna Gain:	2 dBi
Ratings:	DC 5V From adapter

4.2 Test Setup Configuration

See test photographs attached in EUT TEST SETUP PHOTOGRAPHS for the actual connections between Product and support equipment.

4.3 Support Equipment

No.	Device Type	Brand	Model	Series No.	Data Cable	Power Cord
1.	---	---	--	---	---	--

Notes:

1. All the equipment/cables were placed in the worst-case configuration to maximize the emission during the test.
2. Grounding was established in accordance with the manufacturer's requirements and conditions for the intended use.

4.4 Channel List

CH	Frequency (MHz)	CH	Frequency (MHz)	CH	Frequency (MHz)	CH	Frequency (MHz)
1	2412	2	2417	3	2422	4	2427
5	2432	6	2437	7	2442	8	2447
9	2452	10	2457	11	2462	12	2467
13	2472						

4.5 Test Mode

All test mode(s) and condition(s) mentioned were considered and evaluated respectively by performing full tests, the worst data were recorded and reported.

Test mode	Low channel	Middle channel	High channel
Transmitting(802.11b/g/n20)	2412MHz	2442MHz	2472MHz
Receiving(802.11b/g/n20)	2412MHz	2442MHz	2472MHz

4.6 Test Environment

1. Normal Test Conditions:

Humidity(%):	54
Atmospheric Pressure(KPa):	101
Temperature(°C):	26
Test Voltage(DC):	5V

2. Extreme Test Conditions:

For tests at extreme temperatures, measurements shall be made over the extremes of the operating temperature range as declared by the manufacturer.

Test Conditions	LT	HT
Temperature (°C)	-10	35

5. Test Facility And Test Instrument Used

5.1 Test Facility

All measurement facilities used to collect the measurement data are located at Shenzhen BCTC Testing Co., Ltd. Address:1-2/F., Building B, Pengzhou Industrial Park, No.158, Fuyuan 1st Road, Zhancheng, Fuhai Subdistrict, Bao'an District, Shenzhen, Guangdong, China. The site and apparatus are constructed in conformance with the requirements of ANSI C63.4 and CISPR 16-1-1 other equivalent standards.

5.2 Test Instrument Used

Item	Equipment	Manufacturer	Type No.	Serial No.	Last calibration	Calibrated until
1	966 chamber	ChengYu	966 Room	966	Jun. 06. 2020	Jun. 05, 2023
2	Receiver	R&S	ESR3	102075	May 24, 2022	May 23, 2023
3	Spectrum Analyzer	Agilent	E4407B	MY45109572	May 24, 2022	May 23, 2023
4	Amplifier	SKET	LAPA_01G18G -45dB	\	May 24, 2022	May 23, 2023
5	Amplifier	Schwarzbeck	BBV9744	9744-0037	May 24, 2022	May 23, 2023
6	TRILOG Broadband Antenna	Schwarzbeck	VULB 9163	942	May 26, 2022	May 25, 2023
7	Horn Antenna	Schwarzbeck	BBHA9120D	1541	May 26, 2022	May 25, 2023
8	band rejection filter	ZBSF	ZBSF-C2441.5	1706003606	May 24, 2022	May 23, 2023
9	Signal Generator	Keysight	N5181A	MY50143748	May 24, 2022	May 23, 2023
10	Communication test set	R&S	CMU200	119435	May 24, 2022	May 23, 2023
11	Spectrum Analyzer	Keysight	N9020A	MY49100060	May 24, 2022	May 23, 2023
12	Signal Generator	Keysight	N5182B	MY56200519	May 24, 2022	May 23, 2023
13	Power Meter	Keysight	E4419	\	May 24, 2022	May 23, 2023
14	Power Sensor	Keysight	E9300A	\	May 24, 2022	May 23, 2023
15	Horn antenna	Schwarzbeck	BBHA9170	00822	Jun. 06, 2022	Jun. 05, 2023
16	Preamplifier	MITEQ	TTA1840-35-H G	2034381	May 24, 2022	May 23, 2023
17	Software	Frad	EZ-EMC	FA-03A2 RE	\	\
18	Software	Keysight	Keysight.ETSL Test system	1.02.05	\	\
19	D.C. Power Supply	LongWei	TPR-6405D	\	\	\
20	Loop Antenna	Schwarzbeck	FMZB1519B	00014	Jun. 06, 2022	Jun. 05, 2023
21	Communication test set	Agilent	N4010A	MY49081107	May 24, 2022	May 23, 2023
22	Programmable constant temperature and humidity test chamber	DGBELL	BTKS5-150C	\	May 24, 2022	May 23, 2023

6. Information As Required

ETSI EN 300 328 V2.2.2 Annex E

a) The type of modulation used by the equipment:
<input type="checkbox"/> FHSS
<input checked="" type="checkbox"/> other forms of modulation
b) In case of FHSS modulation:
<input type="checkbox"/> In case of non-Adaptive Frequency Hopping equipment: The number of Hopping Frequencies: _
<input type="checkbox"/> In case of Adaptive Frequency Hopping Equipment: The maximum number of Hopping Frequencies: _ The minimum number of Hopping Frequencies: _
<input type="checkbox"/> The (average) Dwell Time: _____ maximum
c) Adaptive / non-adaptive equipment:
<input type="checkbox"/> non-adaptive Equipment
<input checked="" type="checkbox"/> adaptive Equipment without the possibility to switch to a non-adaptive mode
<input type="checkbox"/> adaptive Equipment which can also operate in a non-adaptive mode
d) In case of adaptive equipment:
The Channel Occupancy Time implemented by the equipment: _
<input type="checkbox"/> The equipment has implemented an LBT based DAA mechanism
<input type="checkbox"/> In case of equipment using modulation different from FHSS:
<input type="checkbox"/> The equipment is Frame Based equipment
<input checked="" type="checkbox"/> The equipment is Load Based equipment
<input type="checkbox"/> The equipment can switch dynamically between Frame Based and Load Based equipment
The CCA time implemented by the equipment: μ s
<input type="checkbox"/> The equipment has implemented a non-LBT based DAA mechanism
<input type="checkbox"/> The equipment can operate in more than one adaptive mode
e) In case of non-adaptive Equipment:
The maximum RF Output Power (e.i.r.p.): _
The maximum (corresponding) Duty Cycle:
Equipment with dynamic behaviour, that behaviour is described here. (e.g. the different combinations of duty cycle and corresponding power levels to be declared):.....
f) The worst case operational mode for each of the following tests:
<input checked="" type="checkbox"/> RF Output Power: 802.11b
<input checked="" type="checkbox"/> Power Spectral Density: 802.11b
<input type="checkbox"/> Duty cycle, Tx-Sequence, Tx-gap
<input type="checkbox"/> Accumulated Transmit time, Frequency Occupation & Hopping Sequence (only for FHSS equipment):
<input type="checkbox"/> Hopping Frequency Separation (only for FHSS equipment):
<input type="checkbox"/> Medium Utilization:
<input type="checkbox"/> Adaptivity:
<input checked="" type="checkbox"/> Nominal Channel Bandwidth: 802.11n (HT20)
<input checked="" type="checkbox"/> Transmitter unwanted emissions in the OOB domain: 802.11b
<input checked="" type="checkbox"/> Transmitter unwanted emissions in the spurious domain: 802.11b
<input checked="" type="checkbox"/> Receiver spurious emissions : 802.11b
<input checked="" type="checkbox"/> Receiver blocking : 802.11b
g) The different transmit operating modes (tick all that apply):
<input type="checkbox"/> Operating mode 1: Single Antenna Equipment
<input type="checkbox"/> Equipment with only one antenna
<input type="checkbox"/> Equipment with two diversity antennas but only one antenna active at any moment in time
<input checked="" type="checkbox"/> Smart Antenna Systems with two or more antennas, but operating in a (legacy) mode where only One antenna is used (e.g. IEEE 802.11™ [i.3] legacy mode in smart antenna systems)
<input type="checkbox"/> Operating mode 2: Smart Antenna Systems - Multiple Antennas without beam forming
<input type="checkbox"/> Single spatial stream / Standard throughput / (e.g. IEEE 802.11™ [i.3] legacy mode)

<input type="checkbox"/> High Throughput (> 1 spatial stream) using Nominal Channel Bandwidth 1				
<input type="checkbox"/> High Throughput (> 1 spatial stream) using Nominal Channel Bandwidth 2				
NOTE 1: Add more lines if more channel bandwidths are supported.				
<input type="checkbox"/> Operating mode 3: Smart Antenna Systems - Multiple Antennas with beam forming				
<input type="checkbox"/> Single spatial stream / Standard throughput (e.g. IEEE 802.11™ [i.3] legacy mode)				
<input type="checkbox"/> High Throughput (> 1 spatial stream) using Nominal Channel Bandwidth 1				
<input type="checkbox"/> High Throughput (> 1 spatial stream) using Nominal Channel Bandwidth 2				
NOTE 2: Add more lines if more channel bandwidths are supported.				
h) In case of Smart Antenna Systems:				
The number of Receive chains:				
The number of Transmit chains:				
<input type="checkbox"/> symmetrical power distribution				
<input type="checkbox"/> asymmetrical power distribution				
In case of beam forming, the maximum (additional) beam forming gain:				
NOTE: The additional beam forming gain does not include the basic gain of a single antenna.				
i) Operating Frequency Range(s) of the equipment:				
Operating Frequency Range 1: Refer to section 4.1				
Operating Frequency Range 2: _				
NOTE: Add more lines if more Frequency Ranges are supported.				
j) Nominal Channel Bandwidth(s):				
Nominal Channel Bandwidth 1: <u>17.726MHz(802.11n20) Max.</u>				
NOTE: Add more lines if more channel bandwidths are supported.				
k) Type of Equipment (stand-alone, combined, plug-in radio device, etc.):				
<input checked="" type="checkbox"/> Stand-alone				
<input type="checkbox"/> Combined Equipment (Equipment where the radio part is fully integrated within another type of equipment)				
<input type="checkbox"/> Plug-in radio device (Equipment intended for a variety of host systems)				
<input type="checkbox"/> Other				
l) The normal and the extreme operating conditions that apply to the equipment:				
Refer to section 4.6				
m) The intended combination(s) of the radio equipment power settings and one or more antenna assemblies and their corresponding e.i.r.p. levels:				
Antenna Type:				
<input checked="" type="checkbox"/> Internal antenna (information to be provided in case of conducted measurements)				
Antenna Gain: Refer to section 4.1				
If applicable, additional beamforming gain (excluding basic antenna gain):				
<input type="checkbox"/> Temporary RF connector provided				
<input type="checkbox"/> No temporary RF connector provided				
<input type="checkbox"/> Dedicated Antennas (equipment with antenna connector)				
<input type="checkbox"/> Single power level with corresponding antenna(s)				
<input type="checkbox"/> Multiple power settings and corresponding antenna(s)				
Number of different Power Levels:				
Power Level 1:				
Power Level 2:				
Power Level 3:				
NOTE 1: Add more lines in case the equipment has more power levels.				
NOTE 2: These power levels are conducted power levels (at antenna connector).				
For each of the Power Levels, provide the intended antenna assemblies, their corresponding gains (G) and the resulting e.i.r.p. levels also taking into account the beamforming gain (Y) if applicable				
Power Level 1:				
Number of antenna assemblies provided for this power level:				
	Assembly #	Gain (dBi)	e.i.r.p.(dBm)	Part number or model name
	1			
	2			
	3			
	4			

NOTE 3: Add more rows in case more antenna assemblies are supported for this power level.				
Power Level 2:				
Number of antenna assemblies provided for this power level:				
	Assembly #	Gain (dBi)	e.i.r.p.(dBm)	Part number or model name
	1			
	2			
	3			
	4			
NOTE 4: Add more rows in case more antenna assemblies are supported for this power level.				
Power Level 3:				
Number of antenna assemblies provided for this power level:				
	Assembly #	Gain (dBi)	e.i.r.p.(dBm)	Part number or model name
	1			
	2			
	3			
	4			
NOTE 5: Add more rows in case more antenna assemblies are supported for this power level.				
n) The nominal voltages of the stand-alone radio equipment or the nominal voltages of the combined (host) equipment or test jig in case of plug-in devices:				
Refer to section 4.				
o) Describe the test modes available which can facilitate testing:.....				
p) The equipment type (e.g. Bluetooth®, IEEE 802.11™ [i.3], IEEE 802.15.4™ [i.4], proprietary, etc.):.....				
q) If applicable, the statistical analysis referred to in clause 5.4.1 q) (to be provided as separate attachment)				
r) If applicable, the statistical analysis referred to in clause 5.4.1 r) (to be provided as separate attachment)				
s) Geo-location capability supported by the equipment:				
<input type="checkbox"/> Yes				
<input type="checkbox"/> The geographical location determined by the equipment as defined in clause 4.3.1.13.2 or clause 4.3.2.12.2 is not accessible to the user				
<input checked="" type="checkbox"/> No				
t) Describe the minimum performance criteria that apply to the equipment (see clause 4.3.1.12.3 or clause 4.3.2.11.3):.....				

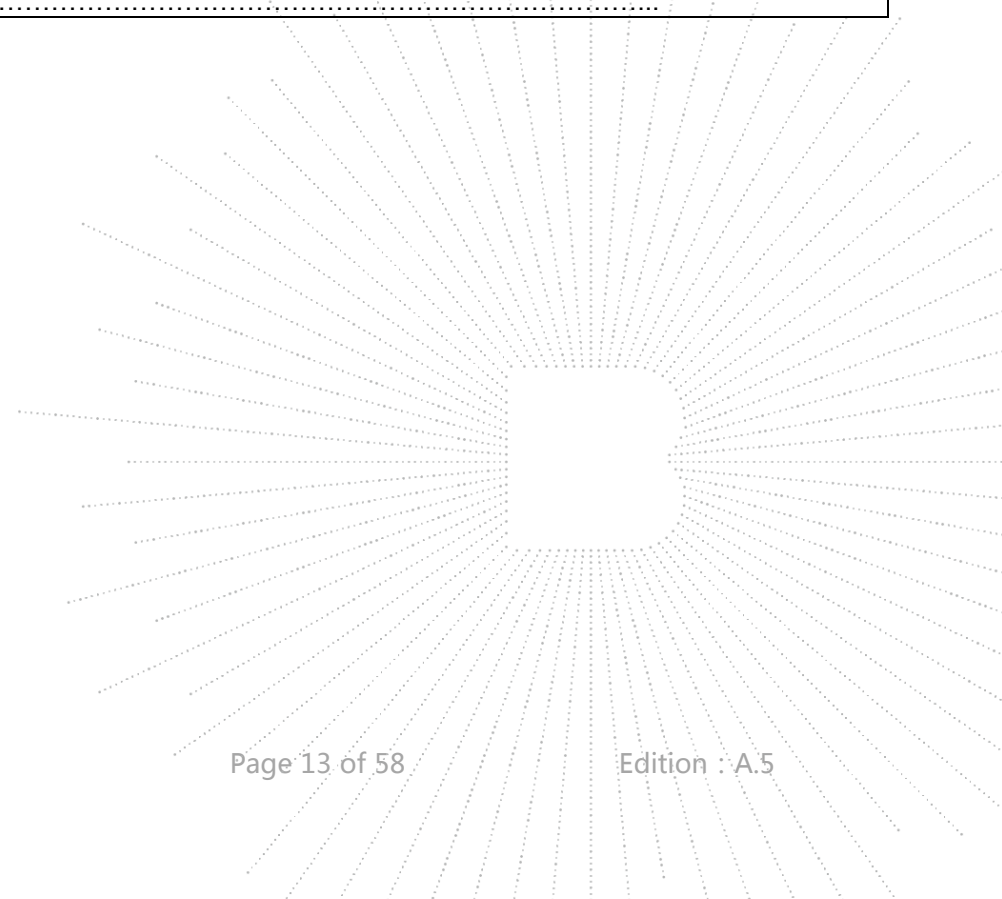

7. RF Output Power

7.1 Block Diagram Of Test Setup

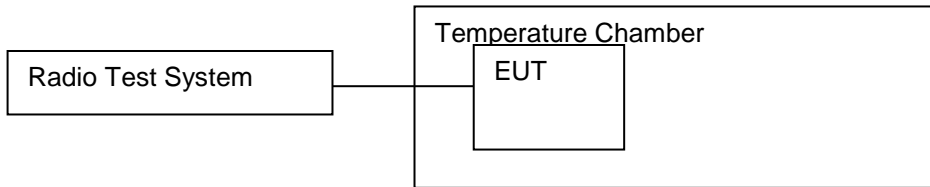

7.2 Limit

For adaptive equipment using wide band modulations other than FHSS, the maximum RF output power shall be 20 dBm.

The maximum RF output power for non-adaptive equipment shall be declared by the supplier and shall not exceed 20 dBm. See clause 5.3.1 m). For non-adaptive equipment using wide band modulations other than FHSS, the maximum RF output power shall be equal to or less than the value declared by the supplier.

This limit shall apply for any combination of power level and intended antenna assembly.

Limit
20dBm

7.3 Test procedure

Step 1:

- Use a fast power sensor suitable for 2.4 GHz and capable of minimum 1 MS/s.
- Use the following settings:
 - Sample speed 1 MS/s or faster.
 - The samples shall represent the RMS power of the signal.
 - Measurement duration: For non-adaptive equipment: equal to the observation period defined in clause 4.3.1.3.2 or clause 4.3.2.4.2. For adaptive equipment, the measurement duration shall be long enough to ensure a minimum number of bursts (at least 10) are captured.

NOTE 1: For adaptive equipment, to increase the measurement accuracy, a higher number of bursts may be used.

Step 2:

- For conducted measurements on devices with one transmit chain:
 - Connect the power sensor to the transmit port, sample the transmit signal and store the raw data. Use these stored samples in all following steps.
- For conducted measurements on devices with multiple transmit chains:
 - Connect one power sensor to each transmit port for a synchronous measurement on all transmit ports.
 - Trigger the power sensors so that they start sampling at the same time. Make sure the time difference between the samples of all sensors is less than 500 ns.
 - For each individual sampling point (time domain), sum the coincident power samples of all ports and store them. Use these summed samples in all following steps.

Step 3:

- Find the start and stop times of each burst in the stored measurement samples.

The start and stop times are defined as the points where the power is at least 30 dB below the highest value of the stored samples in step 2.

NOTE 2: In case of insufficient dynamic range, the value of 30 dB may need to be reduced appropriately.

Step 4:

- Between the start and stop times of each individual burst calculate the RMS power over the burst using the formula below. Save these Pburst values, as well as the start and stop times for each burst.

$$P_{burst} = \frac{1}{k} \sum_{n=1}^k P_{sample}(n)$$

with 'k' being the total number of samples and 'n' the actual sample number

Step 5:

- The highest of all Pburst values (value "A" in dBm) will be used for maximum e.i.r.p. calculations.

Step 6:

- Add the (stated) antenna assembly gain "G" in dBi of the individual antenna.
- If applicable, add the additional beamforming gain "Y" in dB.
- If more than one antenna assembly is intended for this power setting, the maximum overall antenna gain (G or G + Y) shall be used.

- The RF Output Power (P) shall be calculated using the formula below: $P = A + G + Y$

- This value, which shall comply with the limit given in clause 4.3.1.2.3 or clause 4.3.2.2.3, shall be recorded in the test report.

7.4 Test Result

Condition	Mode	Frequency (MHz)	Max Burst RMS Power (dBm)	Burst Number	Max EIRP (dBm)	Limit (dBm)	Verdict
NVNT	b	2412	11.12	17	13.12	20	Pass
	b	2442	11.24	17	13.24	20	Pass
	b	2472	10.85	25	12.85	20	Pass
	g	2412	9.71	67	11.71	20	Pass
	g	2442	9.98	67	11.98	20	Pass
	g	2472	9.32	67	11.32	20	Pass
	n20	2412	8.57	72	10.57	20	Pass
	n20	2442	8.49	72	10.49	20	Pass
	n20	2472	8.00	72	10.00	20	Pass
NVLT	b	2412	10.92	17	12.92	20	Pass
	b	2442	11.09	17	13.09	20	Pass
	b	2472	10.54	25	12.54	20	Pass
	g	2412	9.28	67	11.28	20	Pass
	g	2442	9.72	67	11.72	20	Pass
	g	2472	9.32	67	11.32	20	Pass
	n20	2412	8.22	72	10.22	20	Pass
	n20	2442	8.35	72	10.35	20	Pass
	n20	2472	7.97	72	9.97	20	Pass
NVHT	b	2412	10.70	17	12.70	20	Pass
	b	2442	10.97	17	12.97	20	Pass
	b	2472	10.50	25	12.50	20	Pass
	g	2412	9.02	67	11.02	20	Pass
	g	2442	9.51	67	11.51	20	Pass
	g	2472	9.24	67	11.24	20	Pass
	n20	2412	8.21	72	10.21	20	Pass
	n20	2442	8.30	72	10.30	20	Pass
	n20	2472	7.55	72	9.55	20	Pass

NOTE: All test conditions were tested and passed, only shows the worst case mode which were recorded in this report.

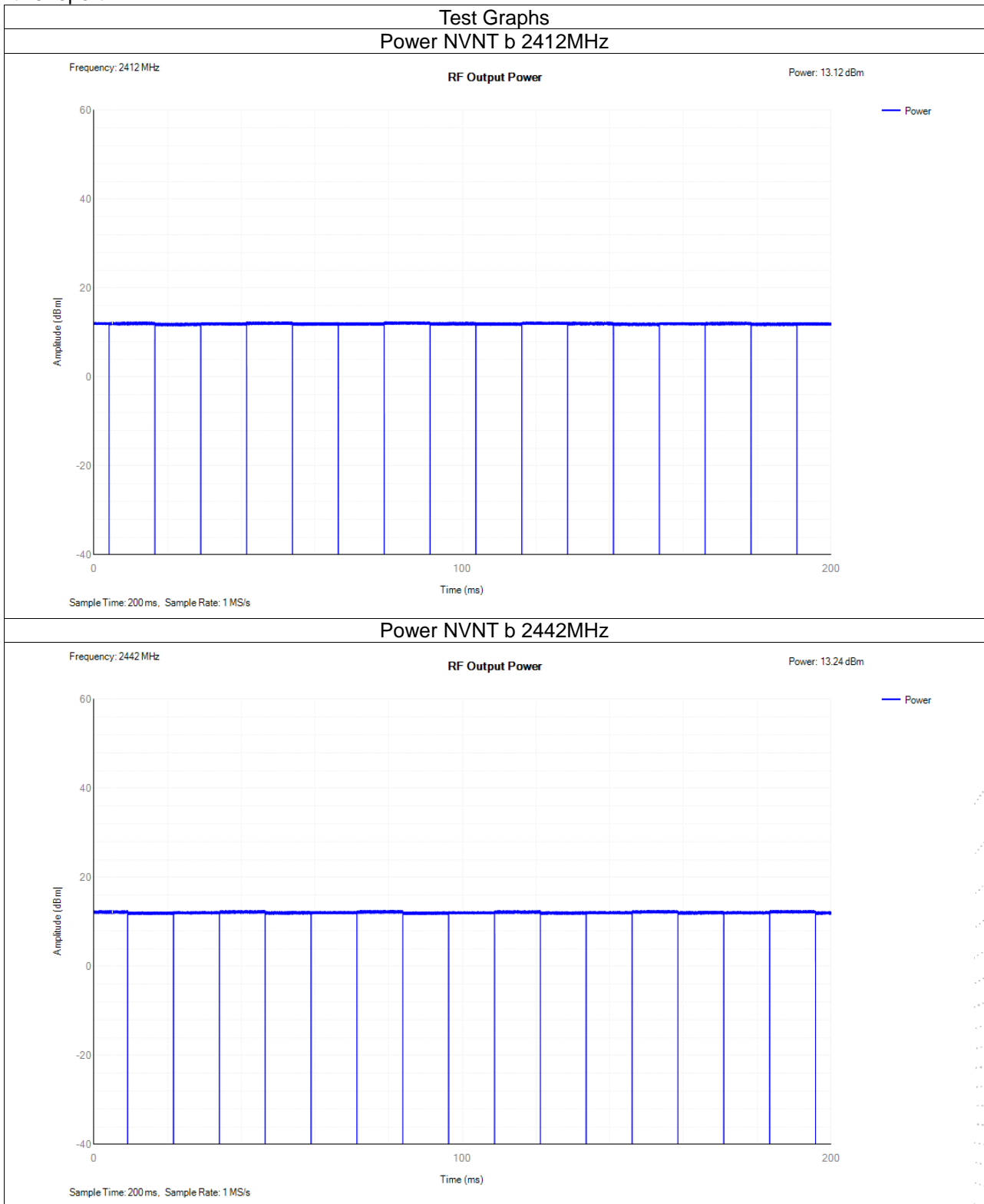

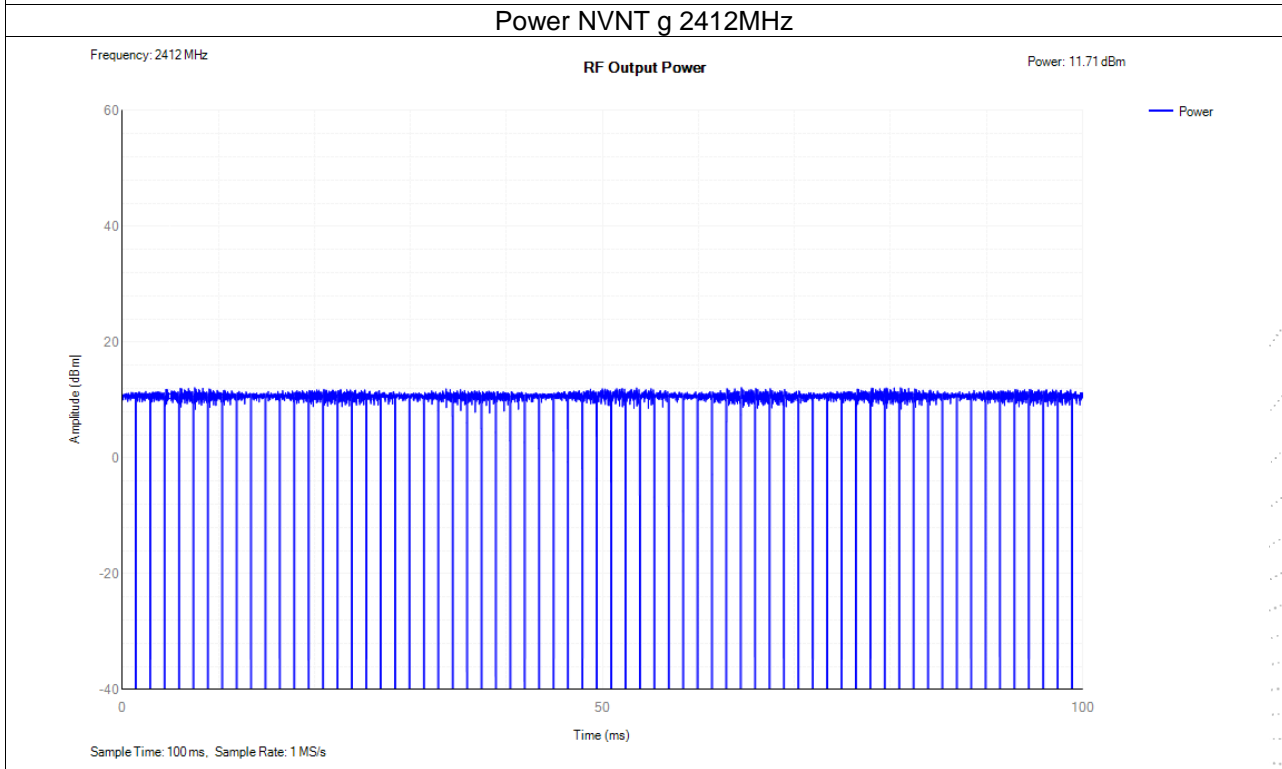
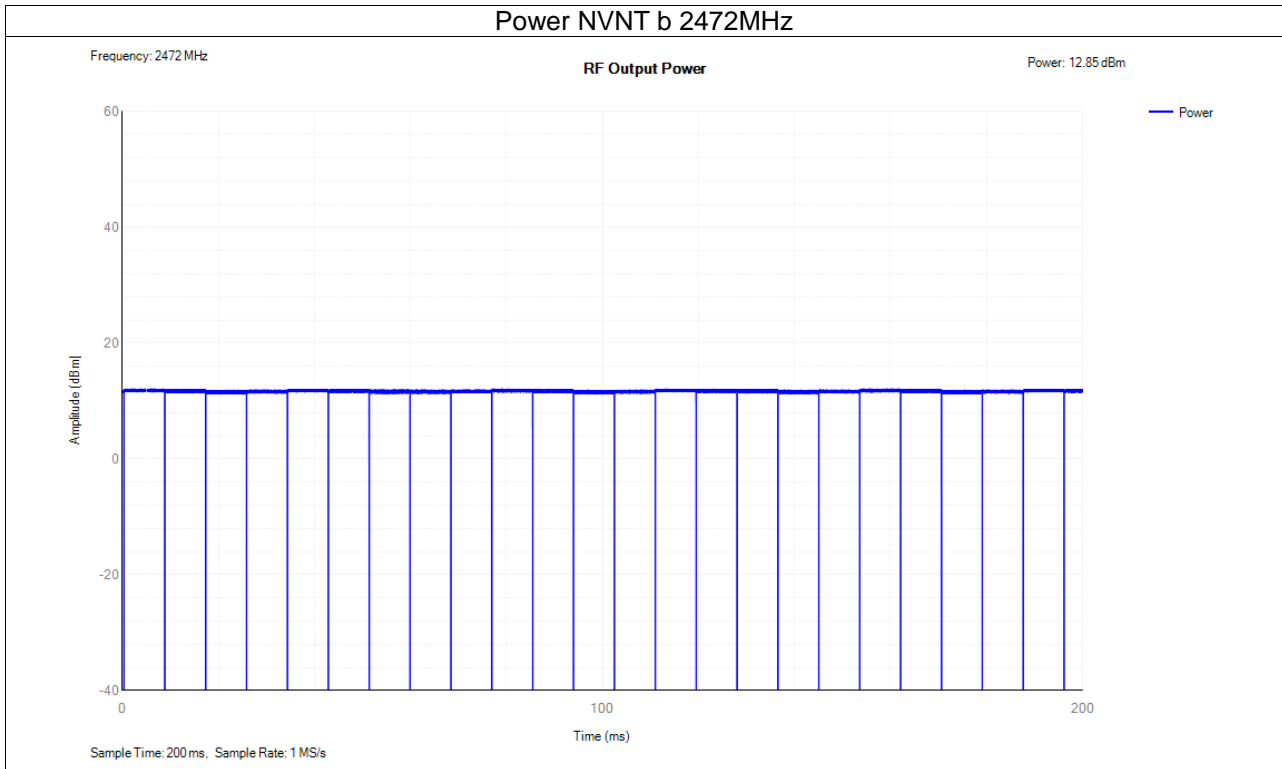

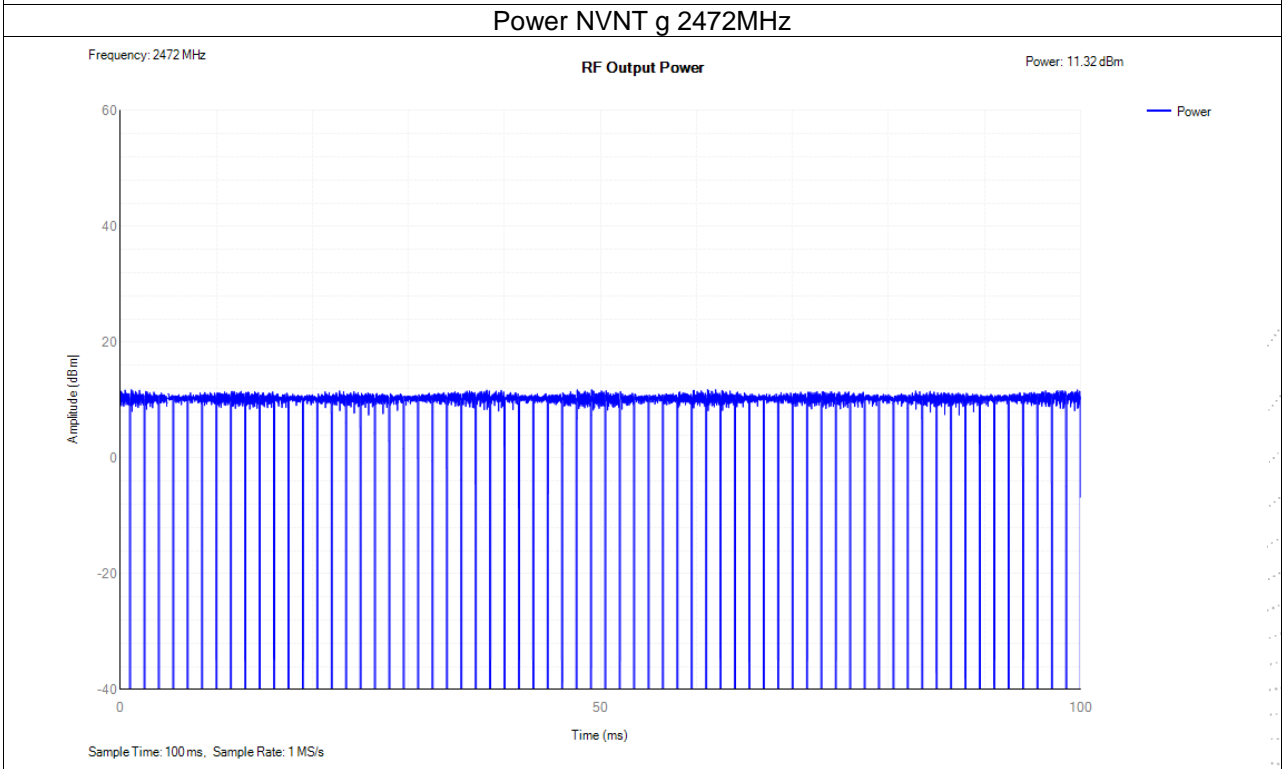
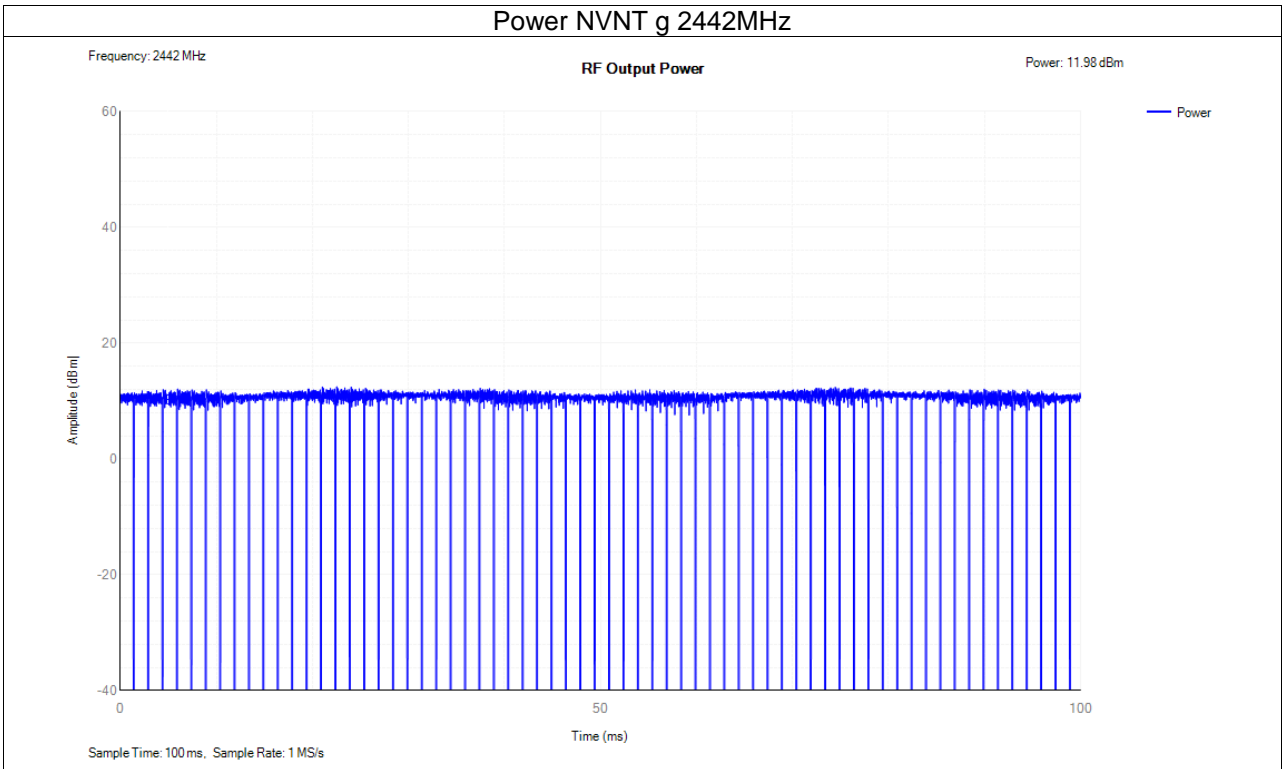

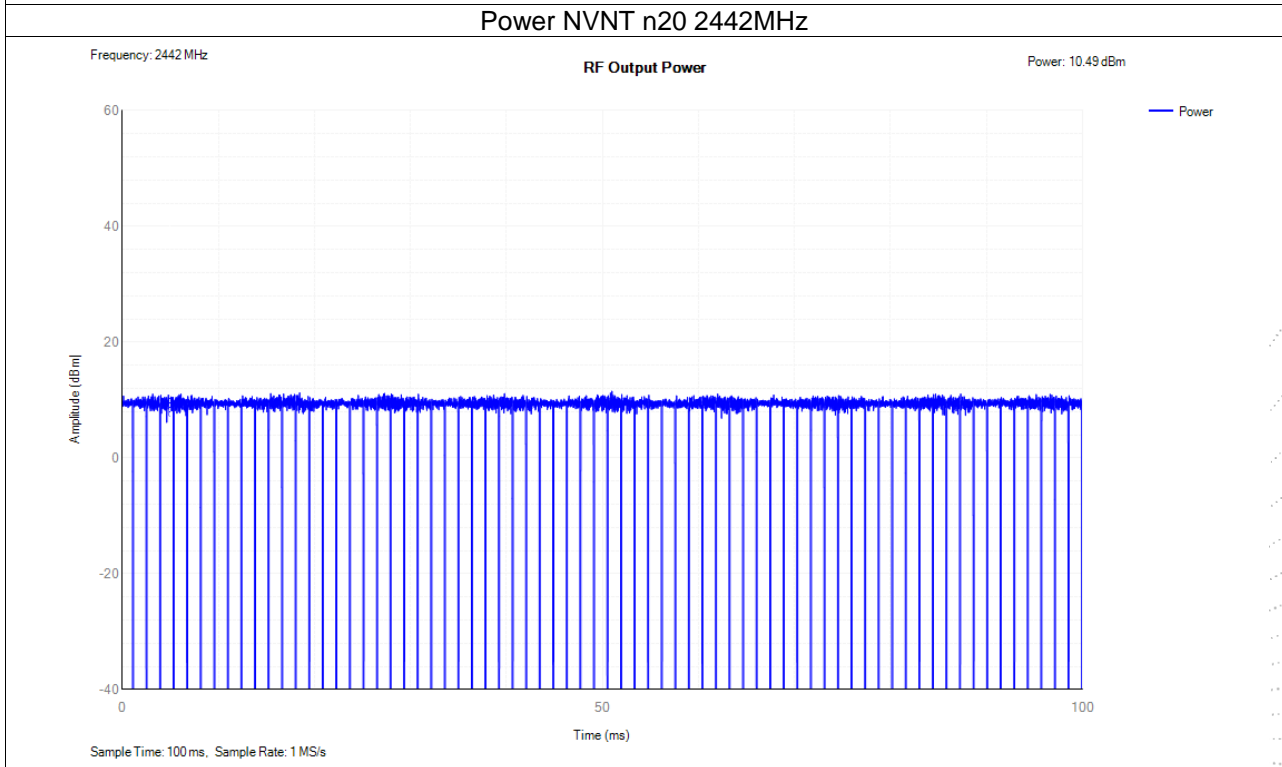
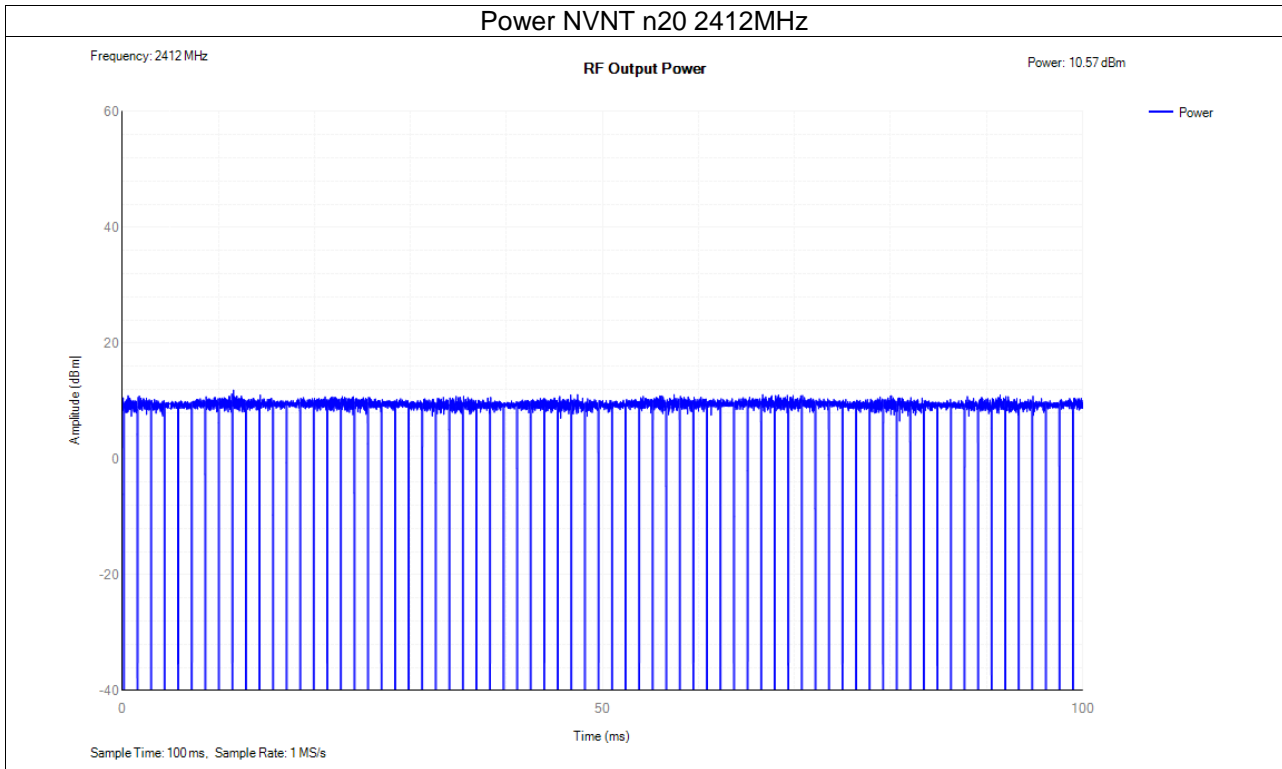

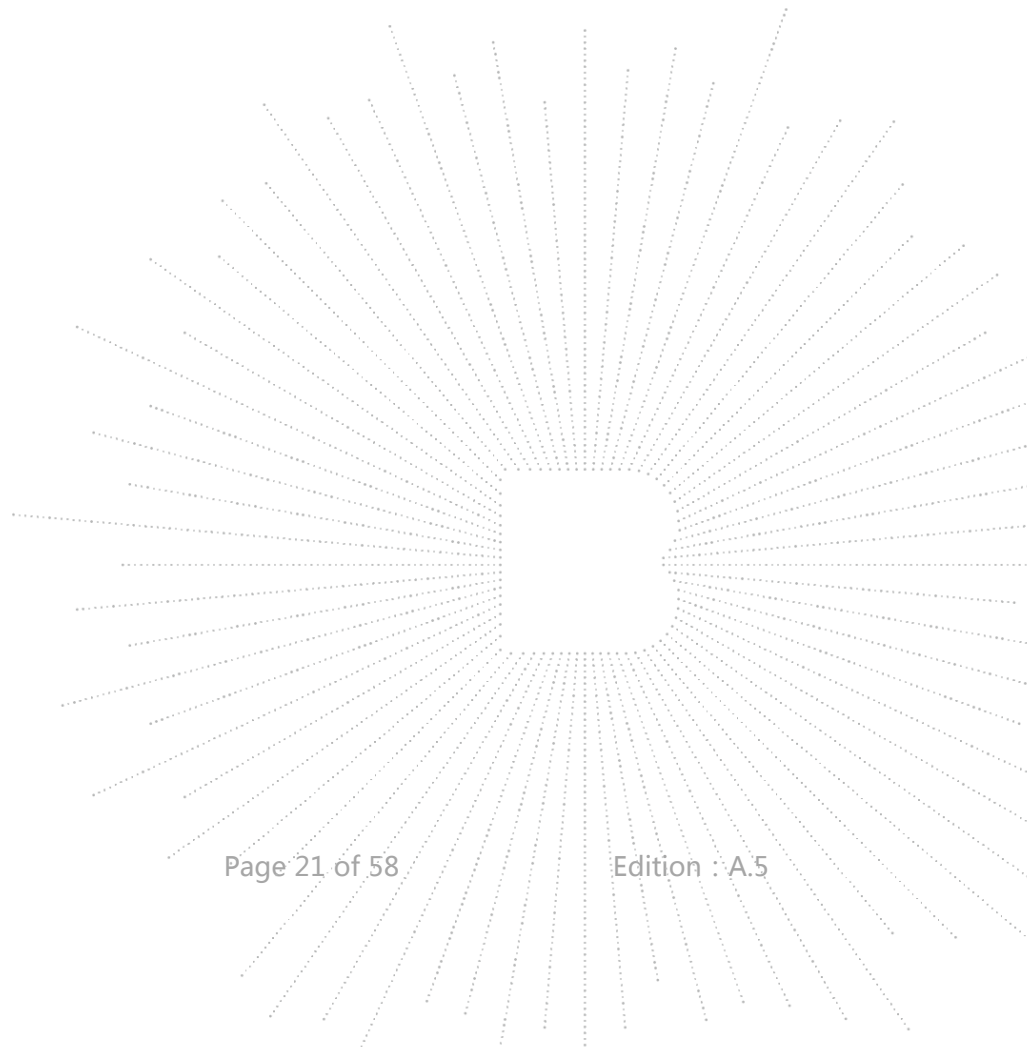
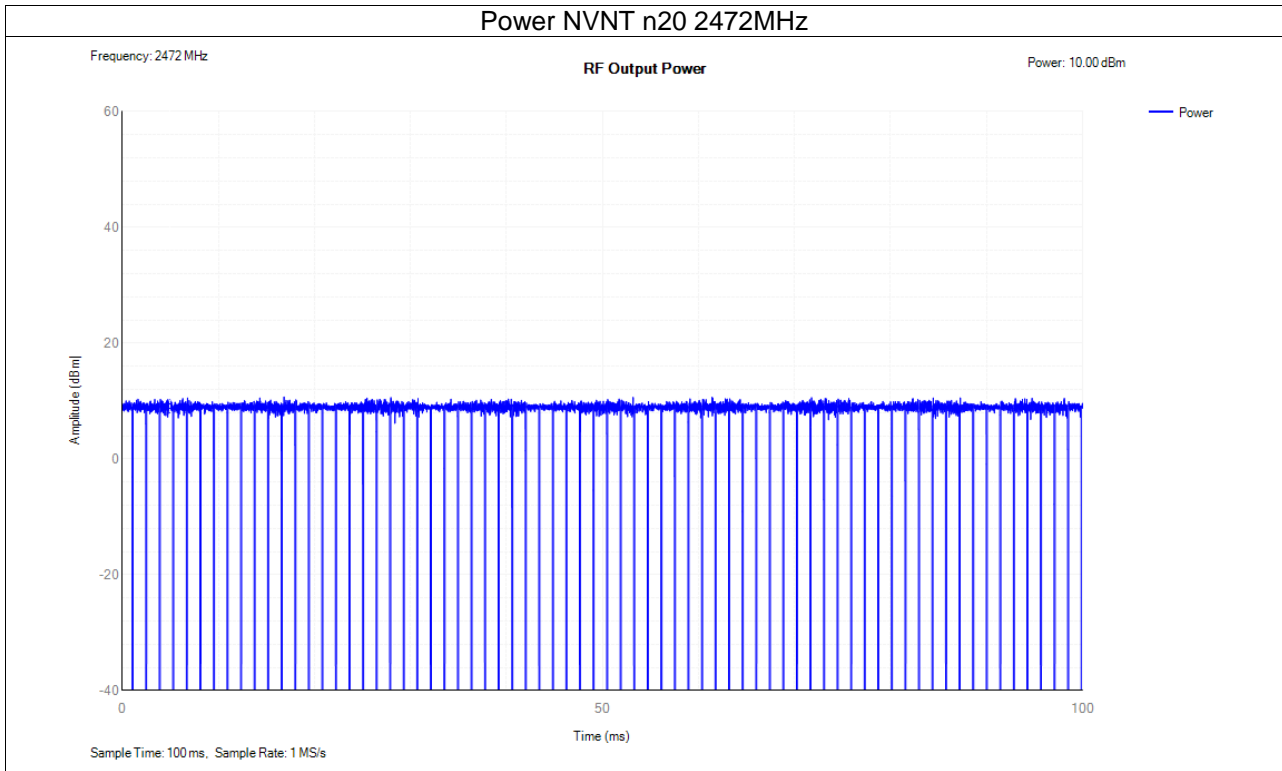

8. Power Spectral Density

8.1 Block Diagram Of Test Setup

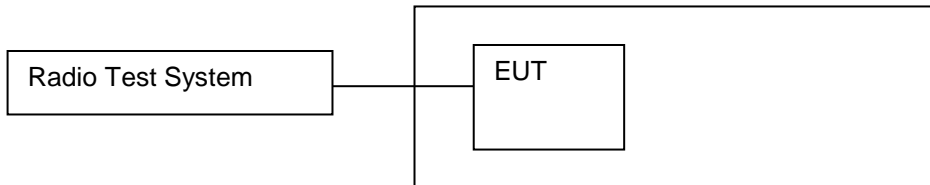

8.2 Limit

For equipment using wide band modulations other than FHSS, the maximum Power Spectral Density is limited to 10 dBm per MHz.

Limit
10dBm/MHz

8.3 Test procedure

Step 1:

Connect the UUT to the spectrum analyser and use the following settings:

- Start Frequency: 2 400 MHz
- Stop Frequency: 2 483,5 MHz
- Resolution BW: 10 kHz
- Video BW: 30 kHz
- Sweep Points: > 8 350

NOTE: For spectrum analysers not supporting this number of sweep points, the frequency band may be segmented.

- Detector: RMS
 - Trace Mode: Max Hold
 - Sweep time: 10 s; the sweep time may be increased further until a value where the sweep time has no impact on the RMS value of the signal
- For non-continuous signals, wait for the trace to stabilize.
Save the data (trace data) set to a file.

Step 2:

For conducted measurements on smart antenna systems using either operating mode 2 or operating mode 3 (see clause 5.1.3.2), repeat the measurement for each of the transmit ports. For each sampling point (frequency domain), add up the coincident power values (in mW) for the different transmit chains and use this as the new data set.

Step 3:

Add up the values for power for all the samples in the file using the formula below.

$$P_{Sum} = \sum_{n=1}^k P_{sample}(n)$$

with 'k' being the total number of samples and 'n' the actual sample number

Step 4:

Normalize the individual values for power (in dBm) so that the sum is equal to the RF Output Power (e.i.r.p.) measured in clause 5.3.2 and save the corrected data. The following formulas can be used:

$$C_{Corr} = P_{Sum} - P_{e.i.r.p.}$$

$$P_{Samplecorr}(n) = P_{Sample}(n) - C_{Corr}$$

with 'n' being the actual sample number

Step 5:

Starting from the first sample $P_{Samplecorr}(n)$ (lowest frequency), add up the power (in mW) of the following samples representing a 1 MHz segment and record the results for power and position (i.e. sample #1 to sample #100). This is the Power Spectral Density (e.i.r.p.) for the first 1 MHz segment which shall be recorded.

Step 6:

Shift the start point of the samples added up in step 5 by one sample and repeat the procedure in step 5 (i.e. sample #2 to sample #101).

Step 7:

Repeat step 6 until the end of the data set and record the Power Spectral Density values for each of the 1 MHz segments.

From all the recorded results, the highest value is the maximum Power Spectral Density for the UUT. This value, which shall comply with the limit given in clause 4.3.2.3.3, shall be recorded in the test report.

8.4 Test Result

Condition	Mode	Frequency (MHz)	Max PSD (dBm/MHz)	Limit (dBm/MHz)	Verdict
NVNT	b	2412	5.07	10	Pass
NVNT	b	2442	5.21	10	Pass
NVNT	b	2472	4.85	10	Pass
NVNT	g	2412	1.72	10	Pass
NVNT	g	2442	3.01	10	Pass
NVNT	g	2472	1.38	10	Pass
NVNT	n20	2412	0.24	10	Pass
NVNT	n20	2442	1.19	10	Pass
NVNT	n20	2472	-0.27	10	Pass

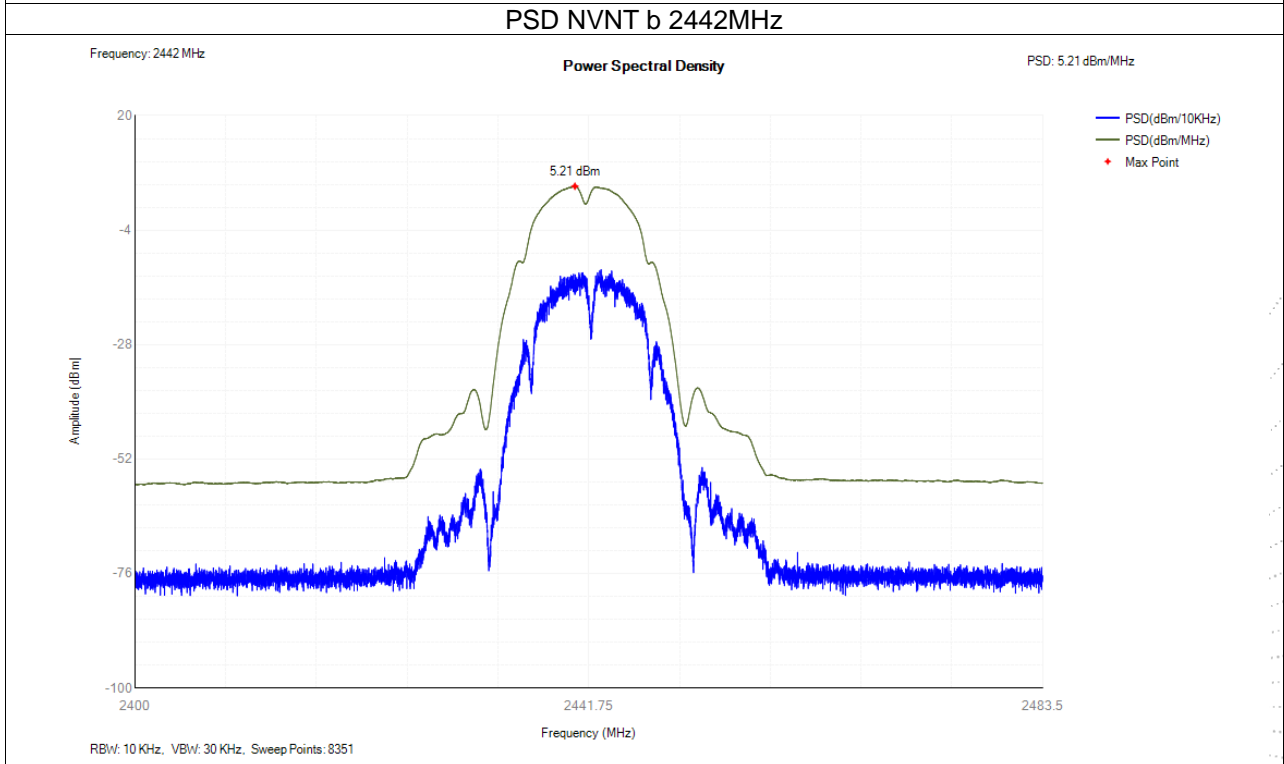
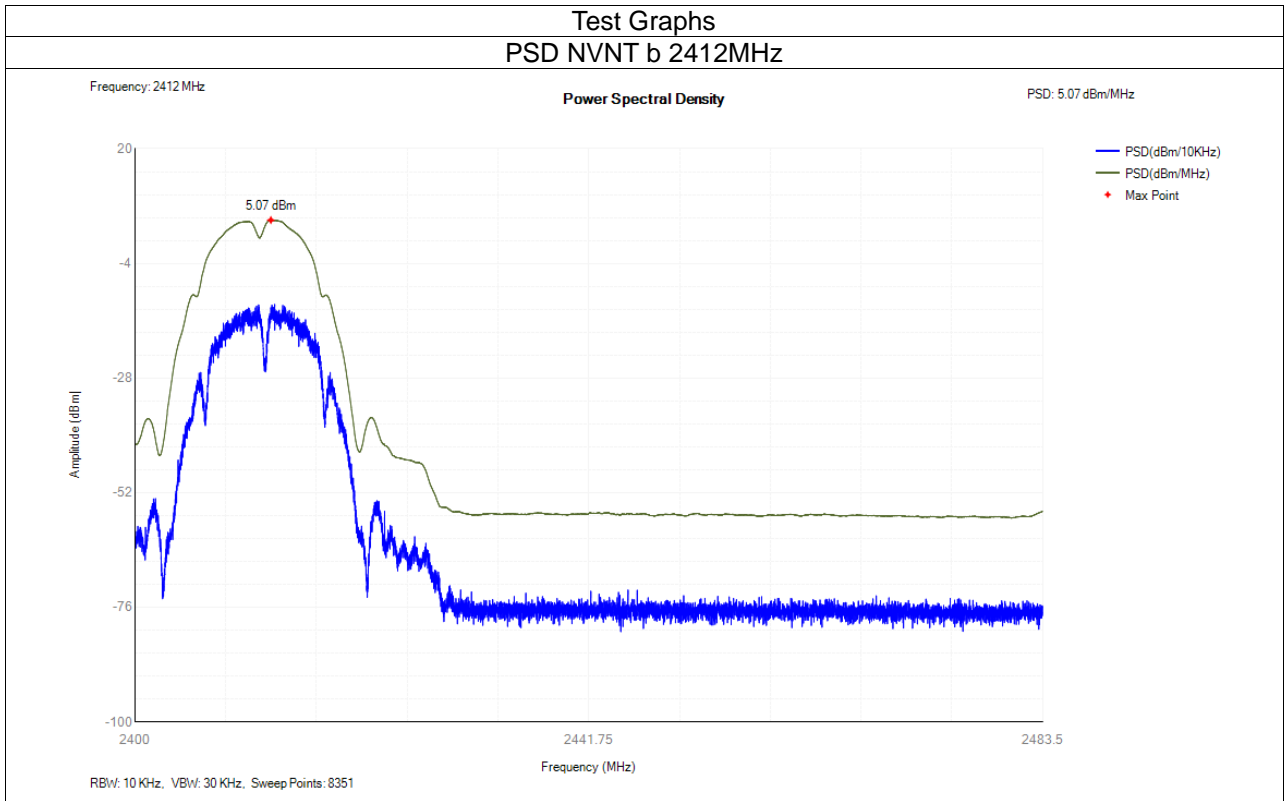

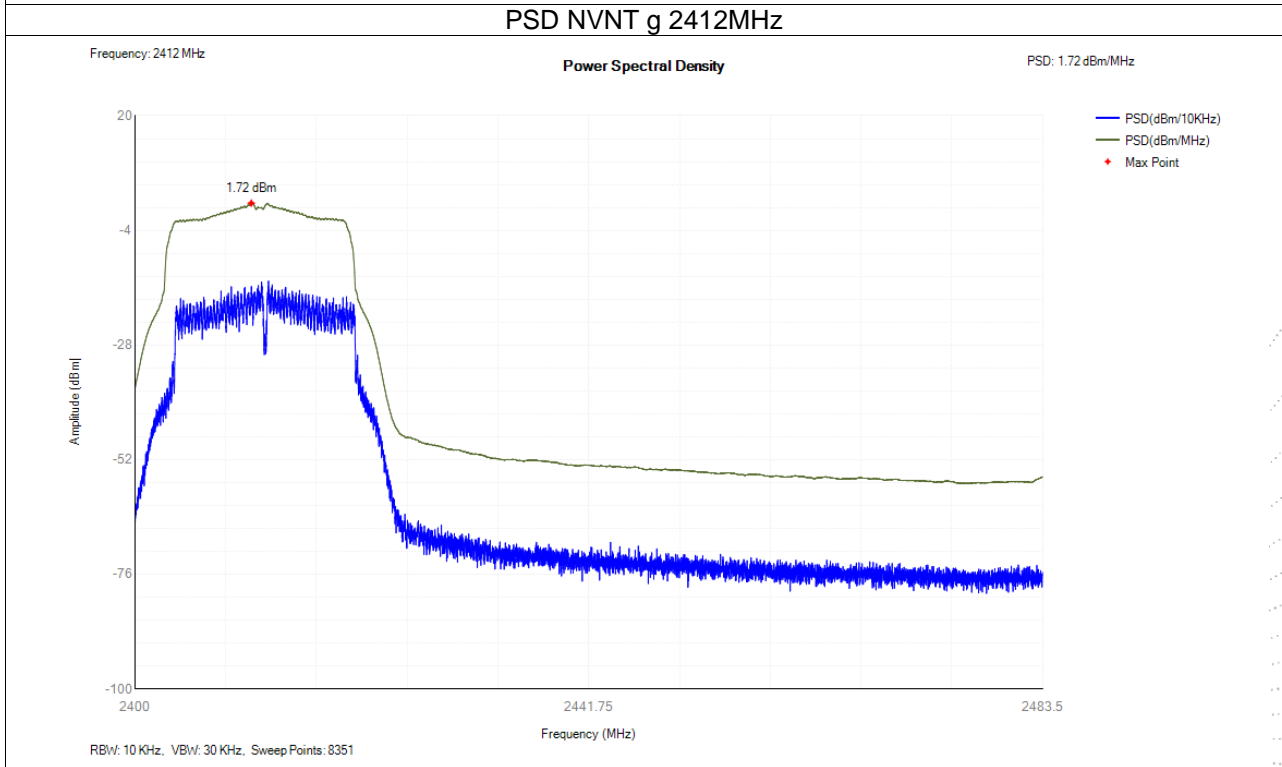
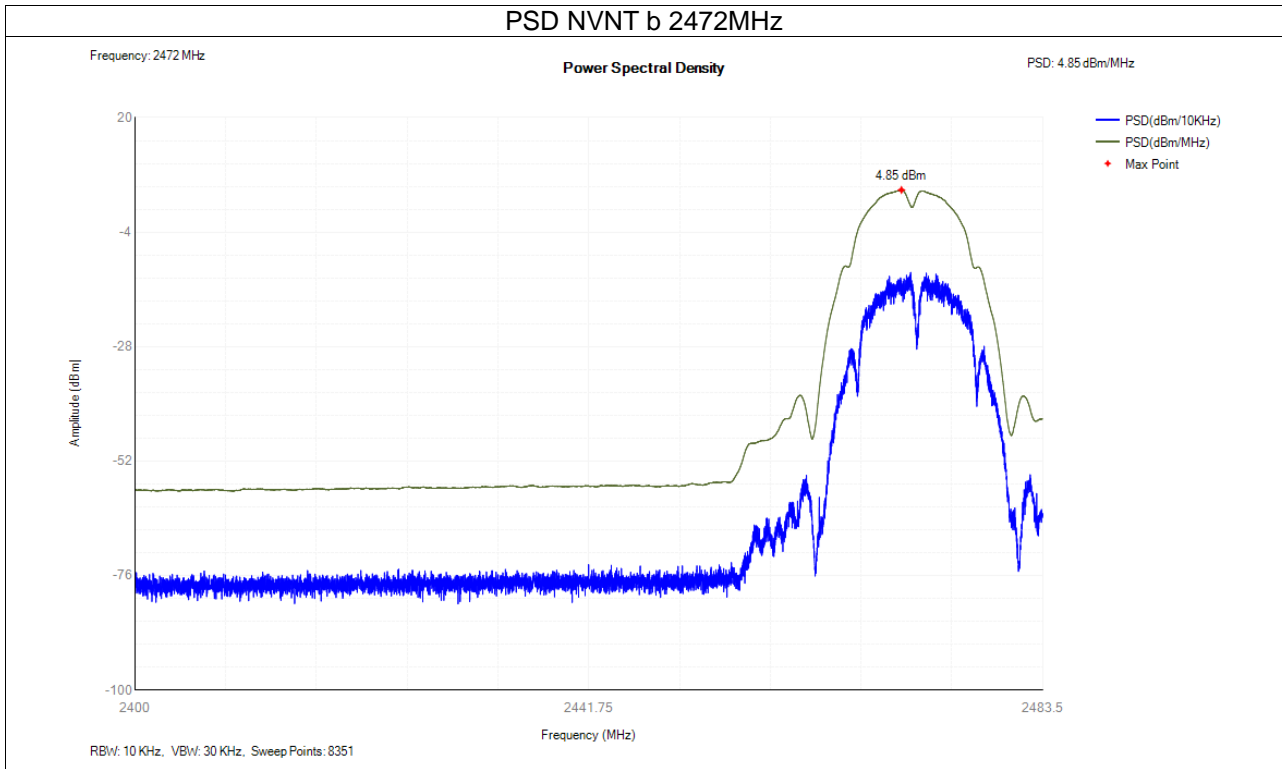

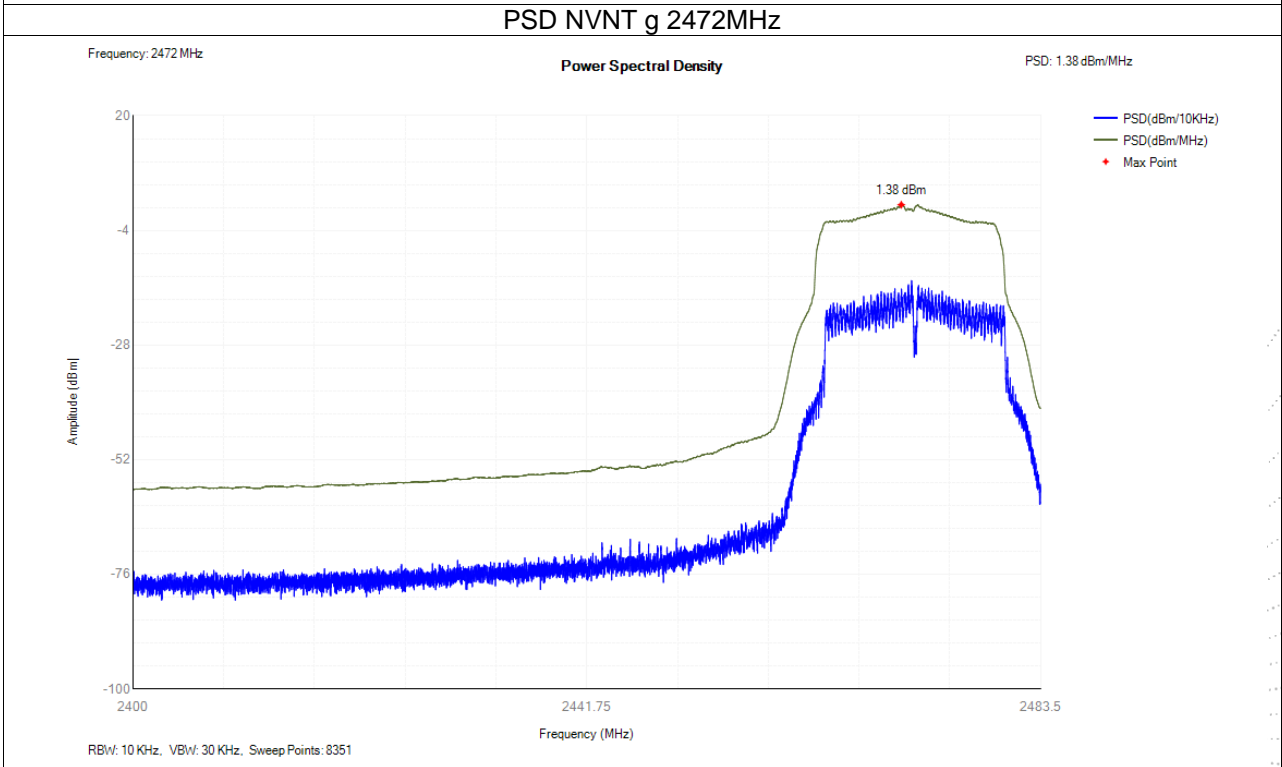
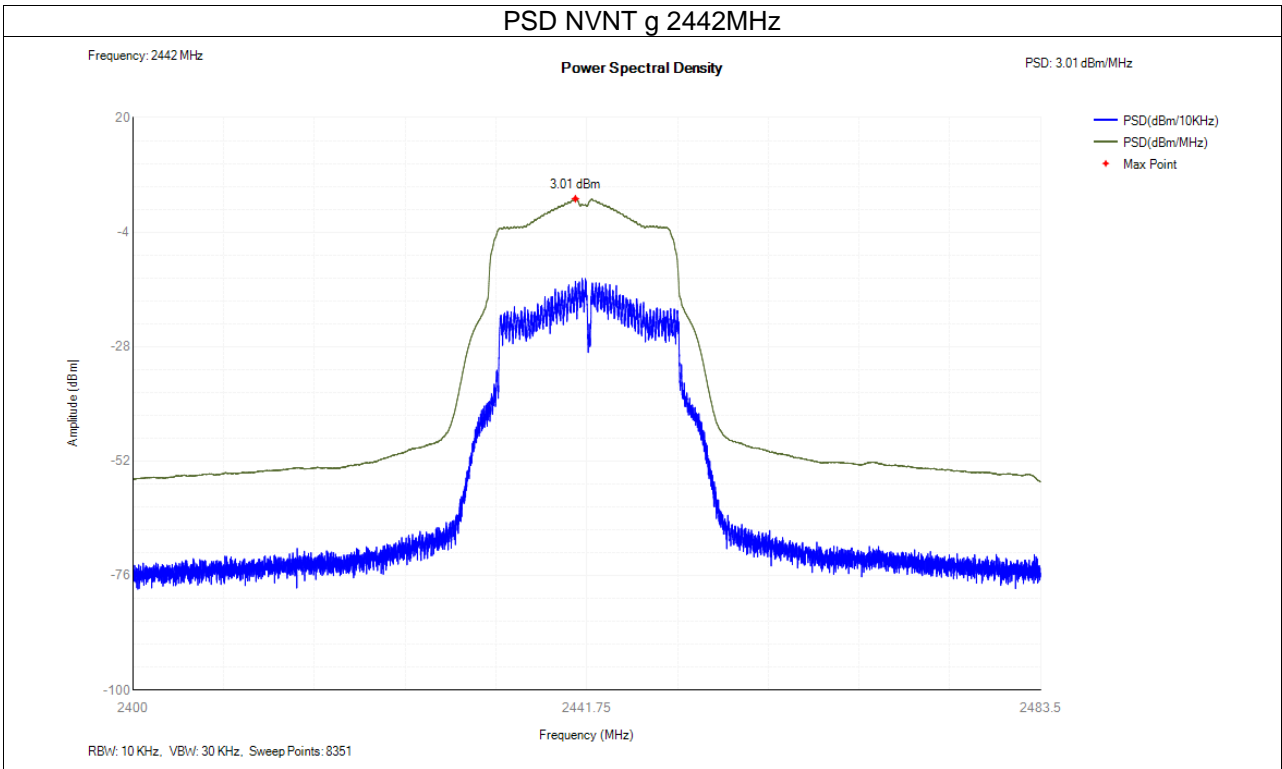

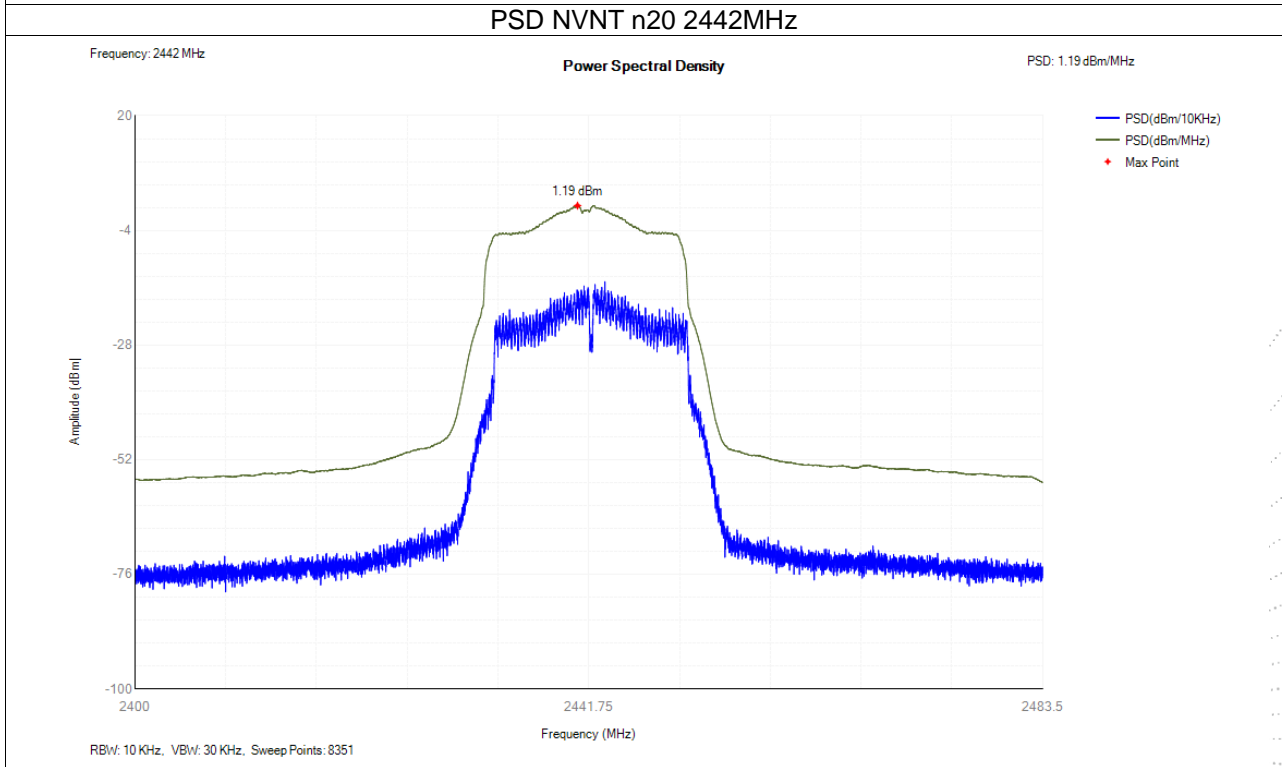
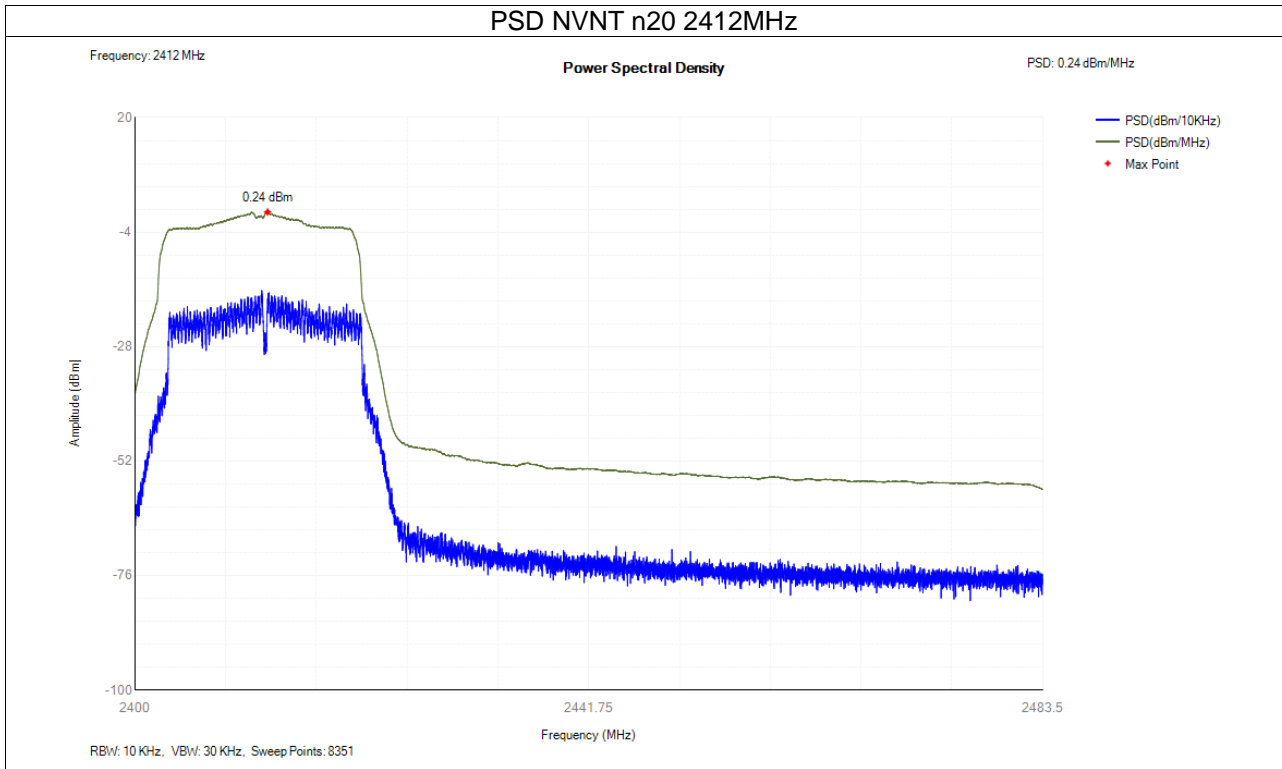

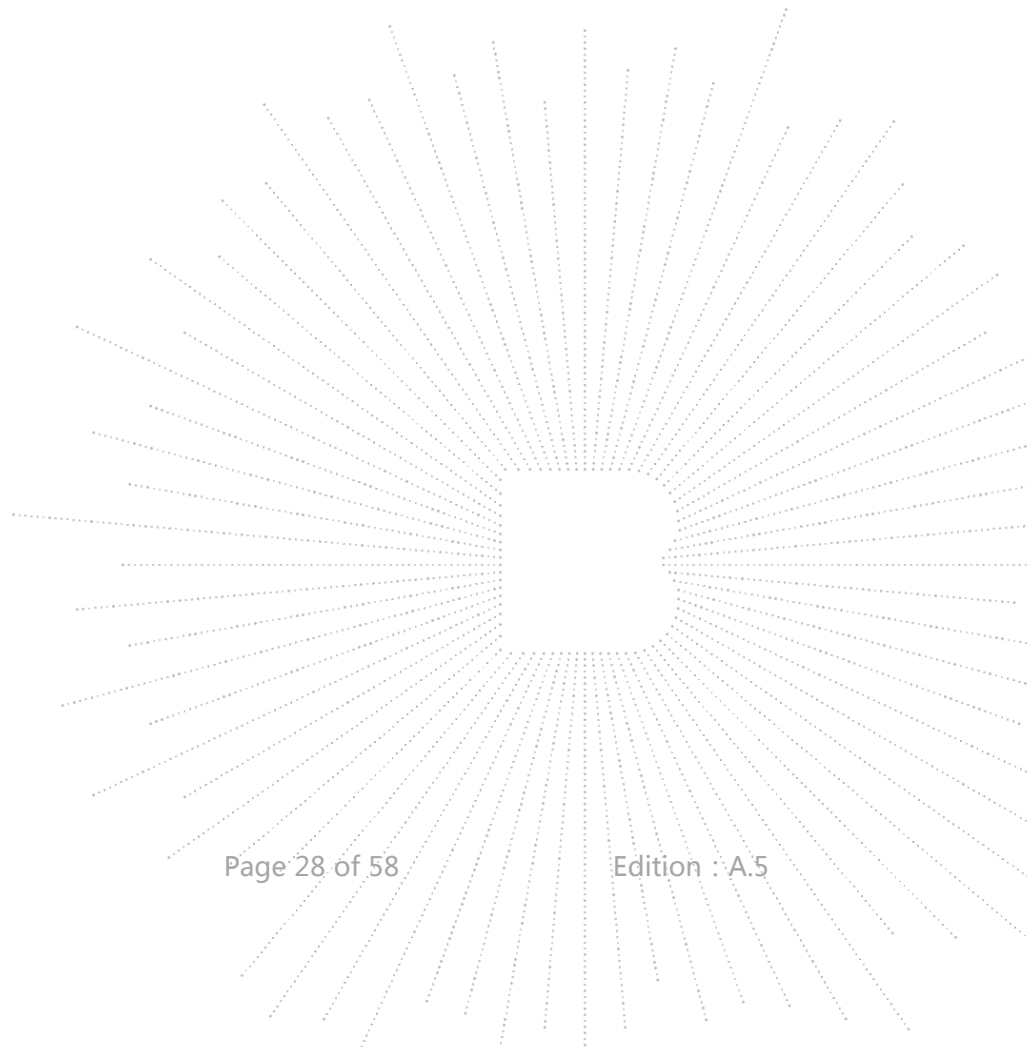
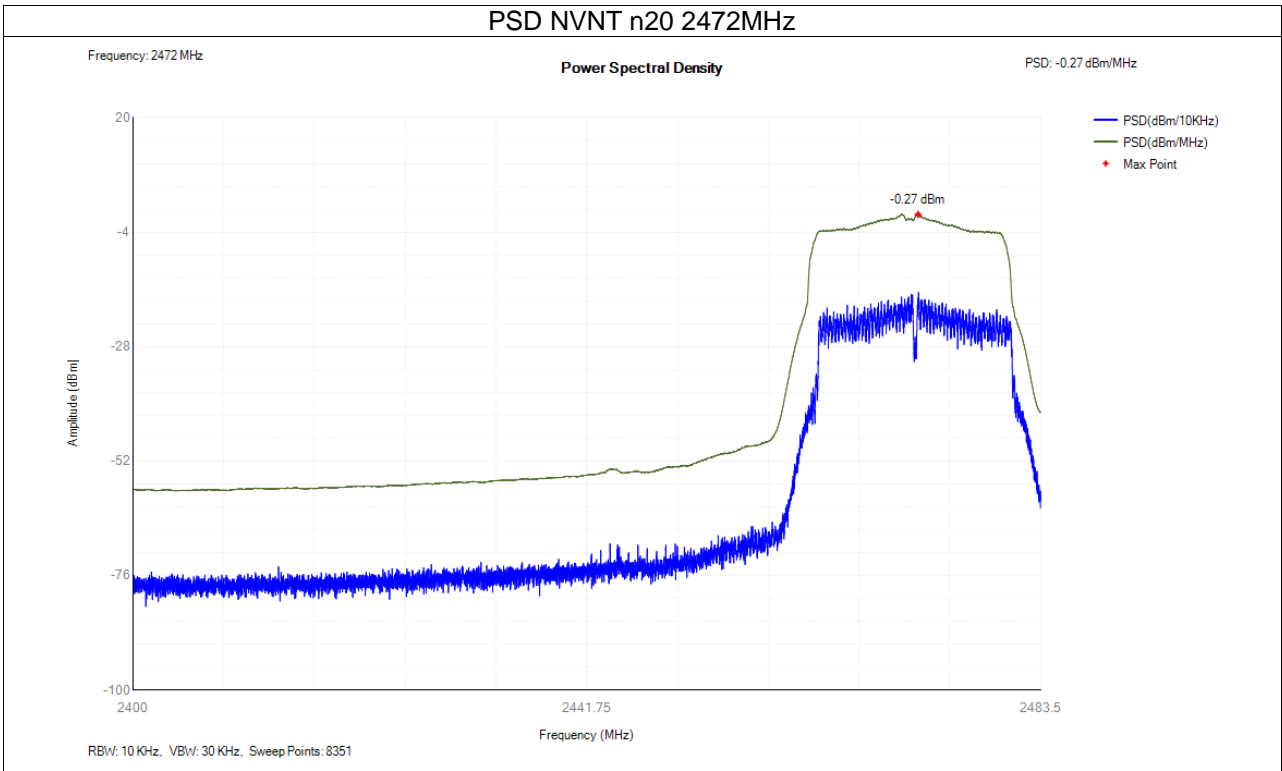

9. Adaptivity

9.1 Block Diagram Of Test Setup

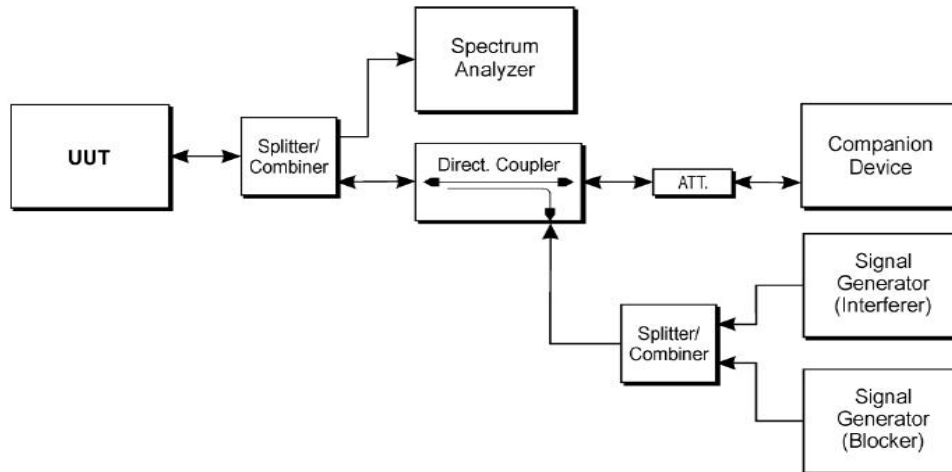

9.2 Limit

The frequency range of the equipment is determined by the lowest and highest

Non-LBT based Detect and Avoid: 1 The frequency shall remain unavailable for a minimum time equal to 1 second after which the channel maybe considered again as an 'available' channel; 2 COT ≤ 40 ms; 3 Idle Period = 5% of COT; 4 Detection threshold level = $-70\text{dBm/MHz} + 20 - \text{Pout E.I.R.P}$ (Pout in dBm);
LBT based Detect and Avoid (Frame Based Equipment): 1 Minimum Clear Channel Assessment (CCA) time = 20 us; 2 CCA observation time declared by the supplier; 3 COT = 1~10 ms; 4 Idle Period = 5% of COT; 5 Detection threshold level = $-70\text{dBm/MHz} + 20 - \text{Pout E.I.R.P}$ (Pout in dBm);
LBT based Detect and Avoid (Load Based Equipment): 1 Minimum Clear Channel Assessment (CCA) time = 20 us; 2 CCA declared by the manufacturer; 3 $\text{COT} \leq (13 / 32) * q$ ms; $q = [4 \sim 32]$; 1.625ms~13ms; 4 Detection threshold level = $-73\text{dBm/MHz} + 20 - \text{Pout E.I.R.P}$ (dBm);
Short Control Signalling Transmissions: Short Control Signalling Transmissions shall have a maximum duty cycle of 10% within an observation period of 50ms.

9.3 Test procedure

Step 1:

The UUT may connect to a companion device during the test. The interference signal generator, the blocking signal generator, the spectrum analyser, the UUT and the companion device are connected using a set-up equivalent to the example given by figure 5 although the interference and blocking signal

generator do not generate any signals at this point in time. The spectrum analyser is used to monitor the transmissions of the UUT in response to the interfering and the blocking signals.

Adjust the received signal level (wanted signal from the companion device) at the UUT to the value defined in table 6

The analyzer shall be set as follows:

- RBW: \geq Occupied Channel Bandwidth (if the analyser does not support this setting, the highest available setting shall be used)
- VBW: $3 \times$ RBW (if the analyser does not support this setting, the highest available setting shall be used)
- Detector Mode: RMS
- Centre Frequency: Equal to the centre frequency of the operating channel
- Span: 0 Hz
- Sweep time: $>$ Channel Occupancy Time of the UUT
- Trace Mode: Clear/Write
 - Trigger Mode: Video

Step 2:

Configure the UUT for normal transmissions with a sufficiently high payload to allow demonstration of compliance of the adaptive mechanism on the channel being tested

Using the procedure defined in clause 5.3.7.2.1.4, it shall be verified that the UUT complies with the maximum Channel Occupancy Time and minimum Idle Period

Step 3: Adding the interference signal

A 100 % duty cycle interference signal is injected on the current operating channel of the UUT. This interference signal shall be a band limited noise signal which has a flat power spectral density, and shall have a bandwidth greater than the Occupied Channel Bandwidth of the UUT. The maximum ripple of this interfering signal shall be $\pm 1,5$ dB within the Occupied Channel Bandwidth and the power spectral density.

Step 4: Verification of reaction to the interference signal

The spectrum analyser shall be used to monitor the transmissions of the UUT on the selected operating channel with the interfering signal injected. This may require the spectrum analyser sweep to be triggered by the start of the interfering signal.

Using the procedure defined in clause 5.3.7.2.1.4, it shall be verified that:

The UUT shall stop transmissions on the current operating channel being tested.

Apart from Short Control Signalling Transmissions (see iii) below), there shall be no subsequent transmissions on this operating channel for a (silent) period defined in clause 4.3.2.5.1.2 step 2. After that, the UUT may have normal transmissions again for the duration of a single Channel Occupancy Time period. Because the interference signal is still present, another silent period as defined in clause 4.3.2.5.1.2 step 2 needs to be included. This sequence is repeated as long as the interfering signal is present.

The UUT may continue to have Short Control Signalling Transmissions on the operating channel while the interference signal is present. These transmissions shall comply with the limits

Alternatively, the equipment may switch to a non-adaptive mode

Step 5: Adding the blocking signal

With the interfering signal present, a 100 % duty cycle CW signal is inserted as the blocking signal

Repeat step 4 to verify that the UUT does not resume any normal transmissions

Step 6: Removing the interference and blocking signal

On removal of the interference and blocking signal the UUT is allowed to start transmissions again on this channel however, it shall be verified that this shall only be done after the period defined in clause 4.3.2.5.1.2 step 2.

Step 7:

The steps 2 to 6 shall be repeated for each of the frequencies to be tested.

9.4 Test Result

Pass

10. Occupied Channel Bandwidth

10.1 Block Diagram Of Test Setup

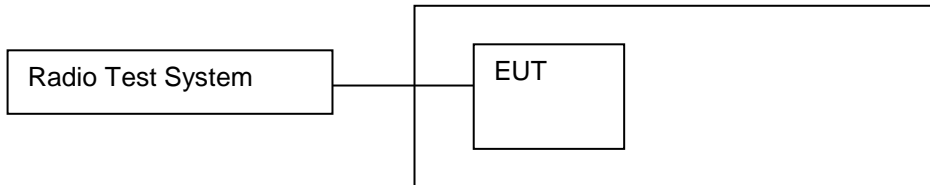

10.2 Limit

The Occupied Channel Bandwidth shall fall completely within the band given in 2.4GHz to 2.4835GHz. In addition, for non-adaptive systems using wide band modulations other than FHSS and with e.i.r.p greater than 10 dBm, the occupied channel bandwidth shall be less than 20 MHz.

10.3 Test procedure

Step 1:

Connect the UUT to the spectrum analyser and use the following settings:

- Centre Frequency: The centre frequency of the channel under test
- Resolution BW: ~ 1 % of the span without going below 1 %
- Video BW: 3 × RBW
- Frequency Span: 2 × Nominal Channel Bandwidth
- Detector Mode: RMS
- Trace Mode: Max Hold
- Sweep time: 1 s

Step 2:

Wait for the trace to stabilize.

Find the peak value of the trace and place the analyser marker on this peak.

Step 3:

Use the 99 % bandwidth function of the spectrum analyser to measure the Occupied Channel Bandwidth of the UUT.

This value shall be recorded.

NOTE: Make sure that the power envelope is sufficiently above the noise floor of the analyser to avoid the noise signals left and right from the power envelope being taken into account by this measurement.

10.4 Test Result

Condition	Mode	Frequency (MHz)	Center Frequency (MHz)	OBW (MHz)	Lower Edge (MHz)	Upper Edge (MHz)	Limit OBW (MHz)	Verdict
NVNT	b	2412	2411.950	11.214	2406.343	2417.557	2400 - 2483.5MHz	Pass
NVNT	b	2472	2471.876	10.996	2466.378	2477.374	2400 - 2483.5MHz	Pass
NVNT	g	2412	2411.967	16.541	2403.696	2420.237	2400 - 2483.5MHz	Pass
NVNT	g	2472	2471.952	16.522	2463.691	2480.213	2400 - 2483.5MHz	Pass
NVNT	n20	2412	2411.971	17.726	2403.109	2420.834	2400 - 2483.5MHz	Pass
NVNT	n20	2472	2471.958	17.717	2463.1	2480.817	2400 - 2483.5MHz	Pass

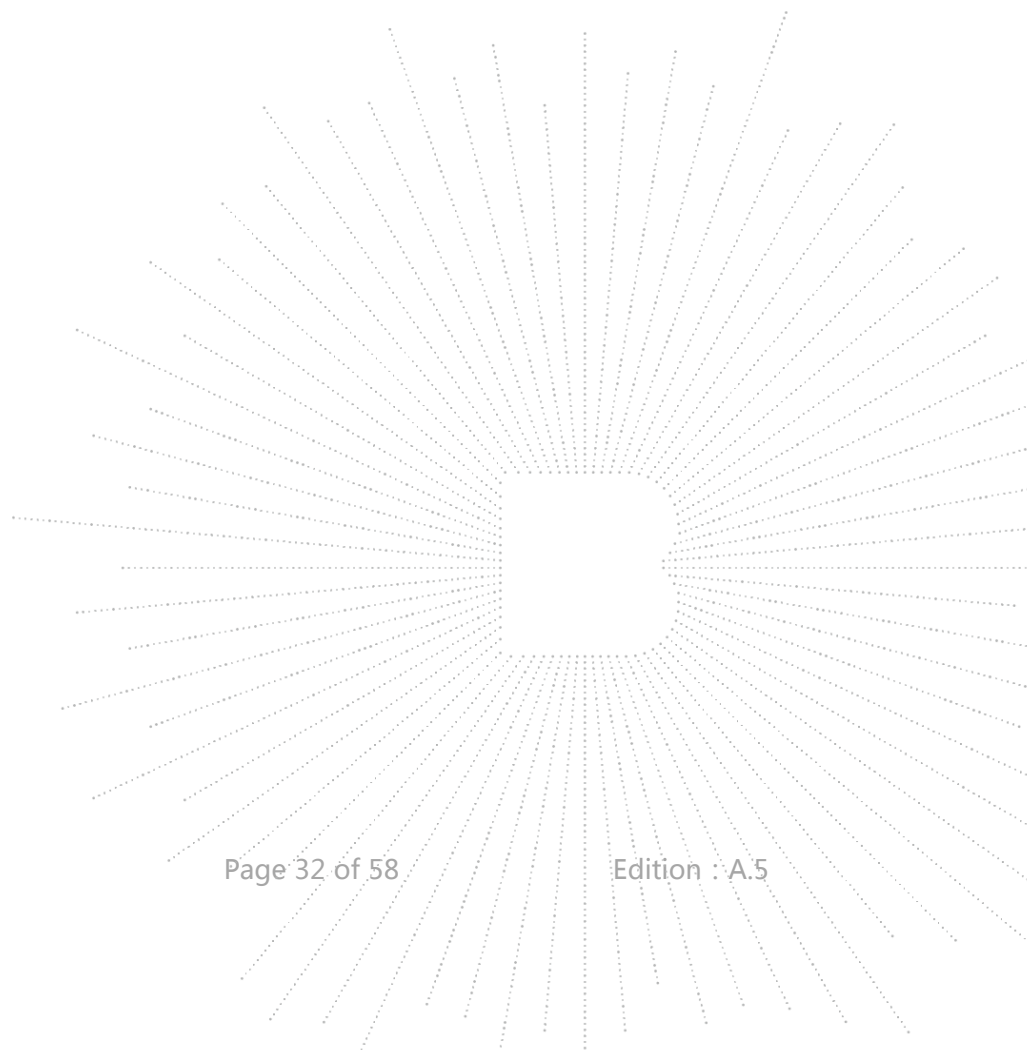

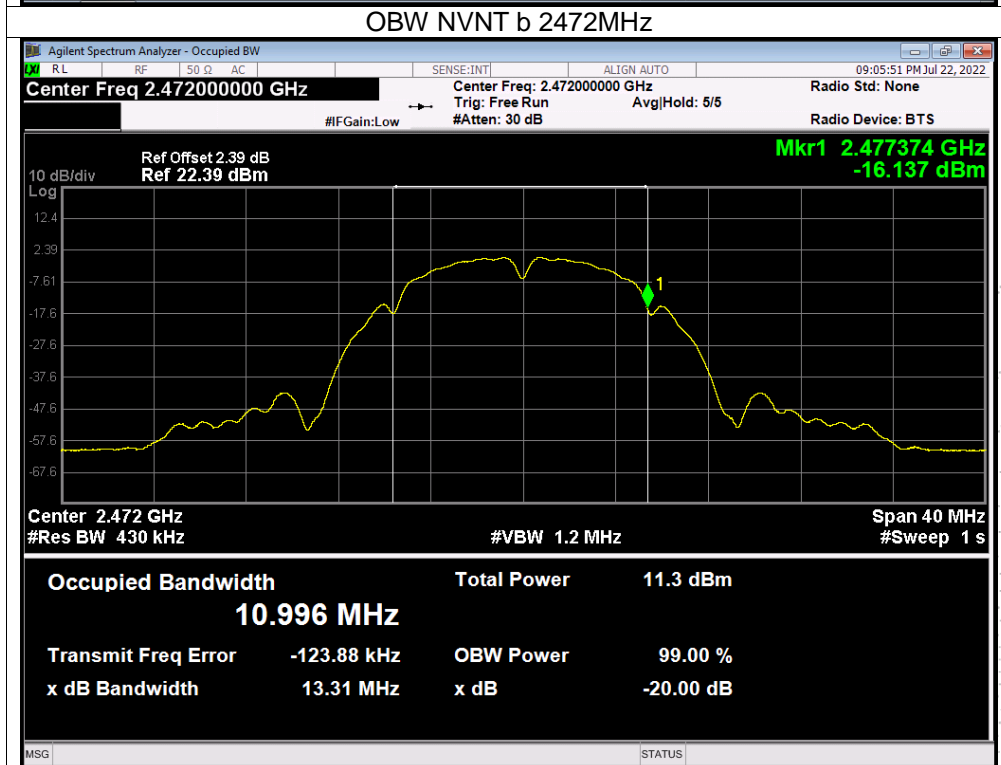
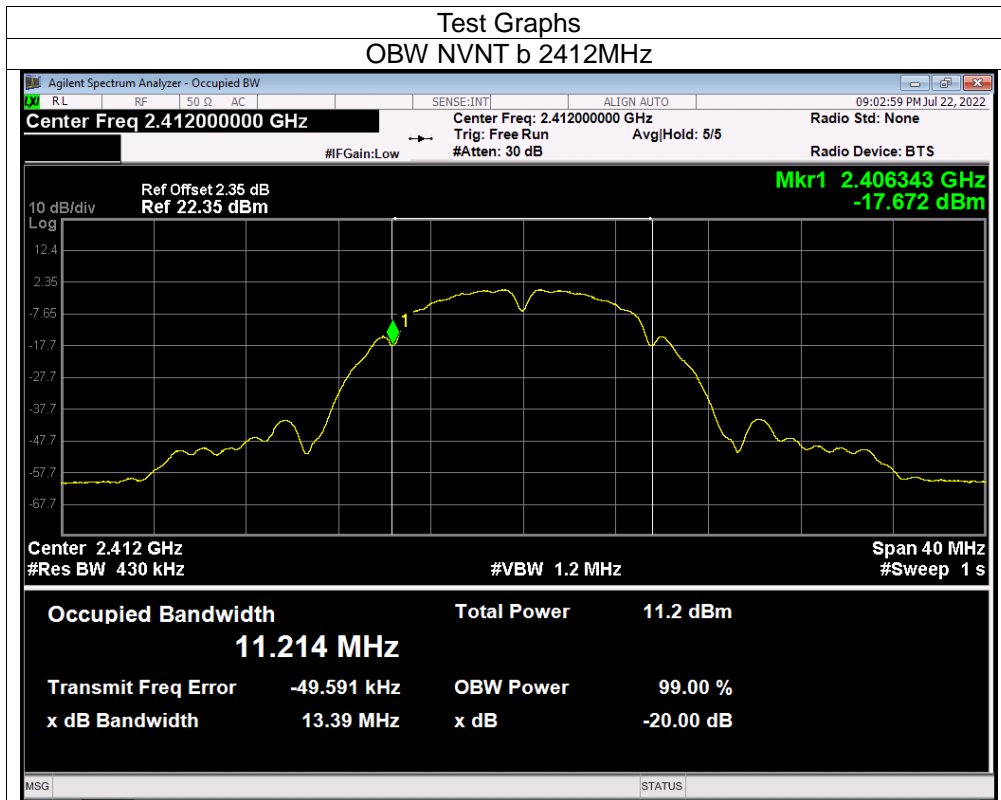

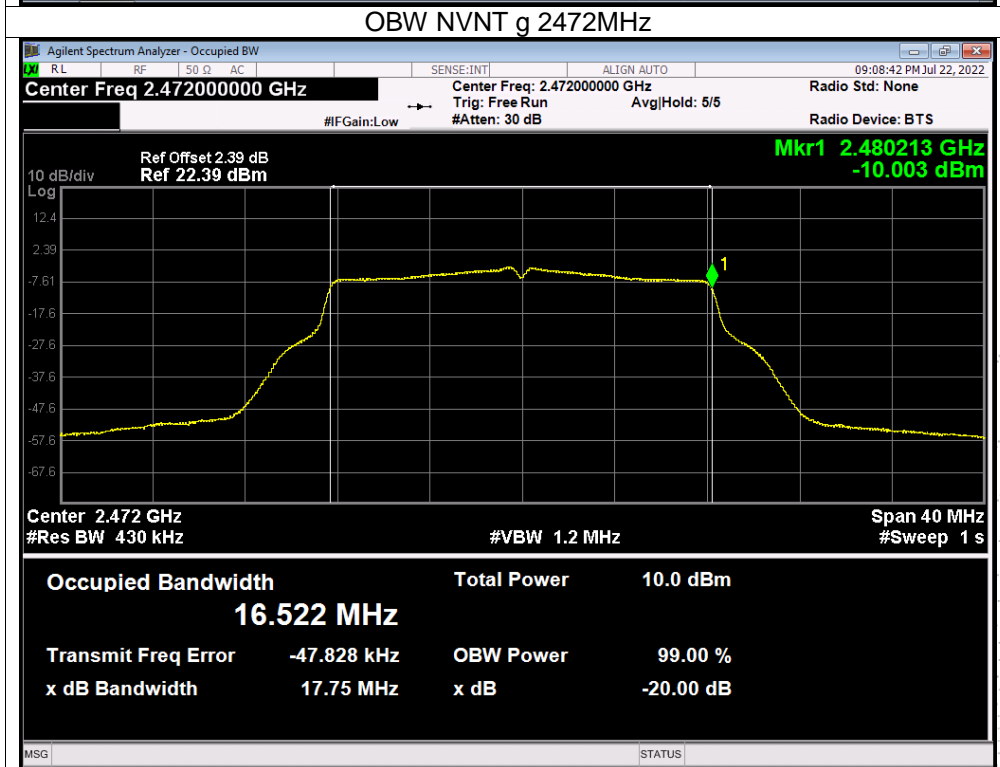
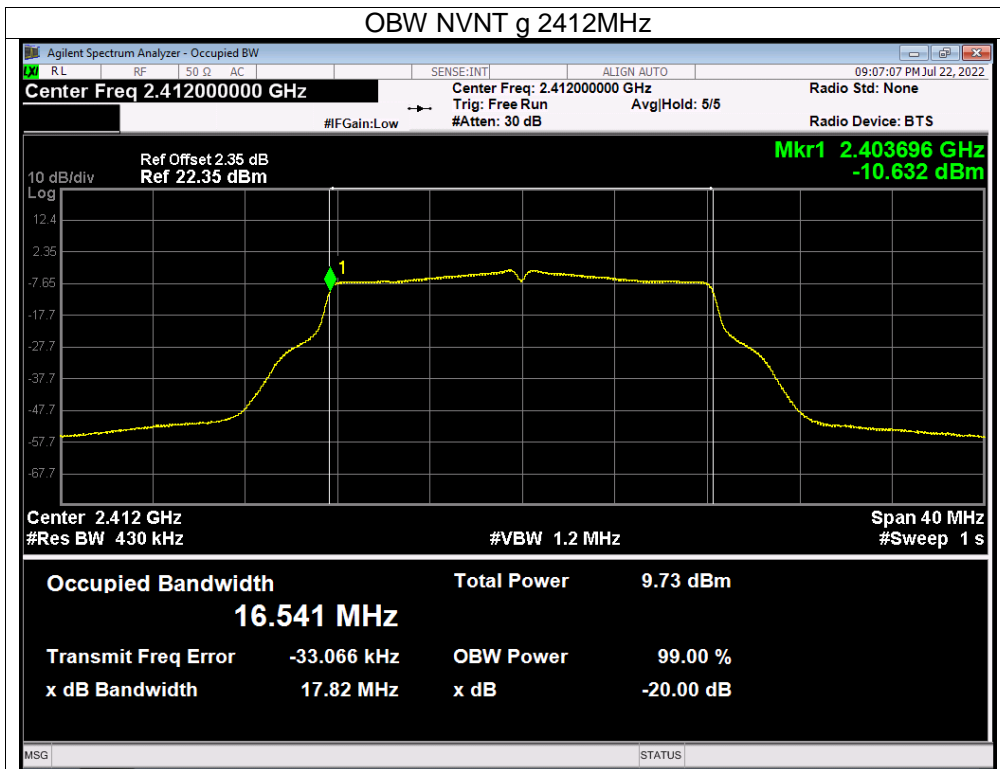

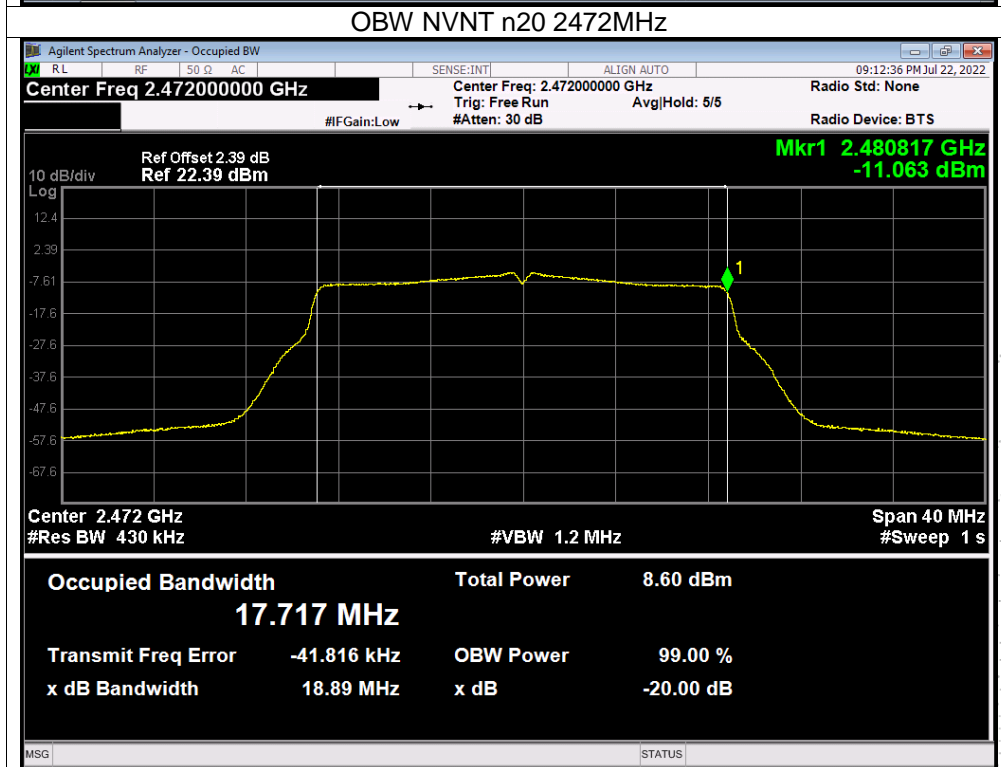
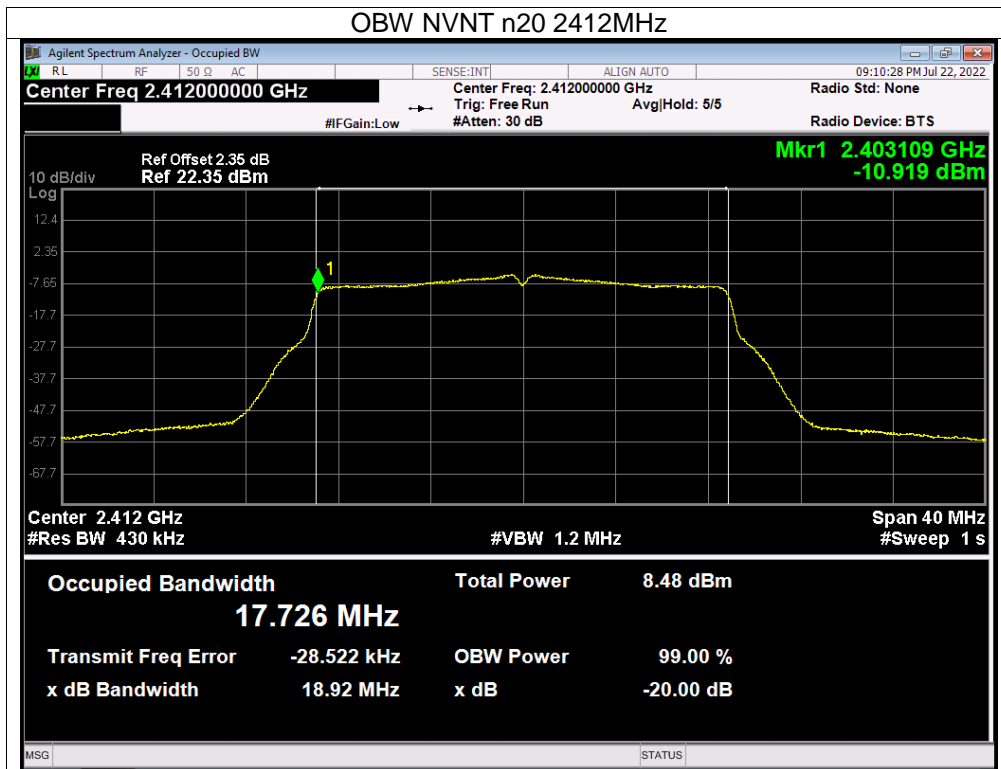

11. Transmitter Unwanted Emissions In The Out-Of-Band Domain

11.1 Block Diagram Of Test Setup

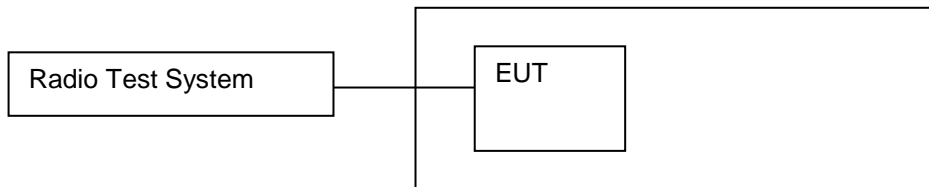

11.2 Limit

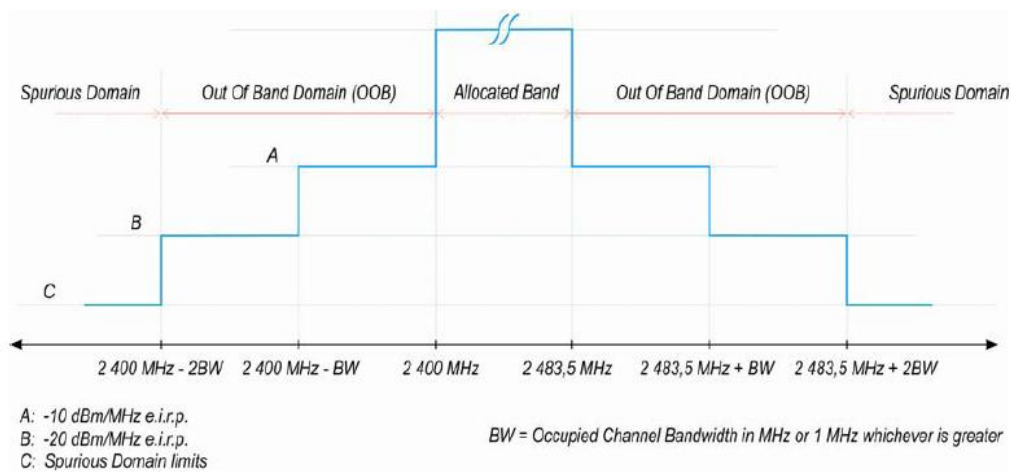

Figure 3: Transmit mask

11.3 Test procedure

The applicable mask is defined by the measurement results from the tests performed under clause 5.3.8 (Occupied Channel Bandwidth).

The test procedure is further as described under clause 5.3.9.2.1.

The Out-of-band emissions within the different horizontal segments of the mask provided in figures 1 and 3 shall be measured using the steps below. This method assumes the spectrum analyser is equipped with the Time Domain Power option.

Step 1:

• Connect the UUT to the spectrum analyser and use the following settings:

- Centre Frequency: 2 484 MHz
- Span: 0 Hz
- Resolution BW: 1 MHz
- Filter mode: Channel filter
- Video BW: 3 MHz
- Detector Mode: RMS
- Trace Mode: Max Hold
- Sweep Mode: Continuous
- Sweep Points: Sweep Time [s] / (1 μ s) or 5 000 whichever is greater
- Trigger Mode: Video trigger

NOTE 1: In case video triggering is not possible, an external trigger source may be used.

- Sweep Time: > 120 % of the duration of the longest burst detected during the measurement of the RF Output Power

Step 2 (segment 2 483,5 MHz to 2 483,5 MHz + BW):

- Adjust the trigger level to select the transmissions with the highest power level.
- For frequency hopping equipment operating in a normal hopping mode, the different hops will result in signal bursts with different power levels. In this case the burst with the highest power level shall be selected.
- Set a window (start and stop lines) to match with the start and end of the burst and in which the RMS power shall be measured using the Time Domain Power function.
- Select RMS power to be measured within the selected window and note the result which is the RMS power within this 1 MHz segment (2 483,5 MHz to 2 484,5 MHz). Compare this value with the applicable limit provided by the mask.
- Increase the centre frequency in steps of 1 MHz and repeat this measurement for every 1 MHz segment within the range 2 483,5 MHz to 2 483,5 MHz + BW. The centre frequency of the last 1 MHz segment shall be set to 2 483,5 MHz + BW - 0,5 MHz (which means this may partly overlap with the previous 1 MHz segment).

Step 3 (segment 2 483,5 MHz + BW to 2 483,5 MHz + 2BW):

- Change the centre frequency of the analyser to 2 484 MHz + BW and perform the measurement for the first 1 MHz segment within range 2 483,5 MHz + BW to 2 483,5 MHz + 2BW. Increase the centre frequency in 1 MHz steps and repeat the measurements to cover this whole range. The centre frequency of the last 1 MHz segment shall be set to 2 483,5 MHz + 2 BW - 0,5 MHz (which means this may partly overlap with the previous 1 MHz segment).

Step 4 (segment 2 400 MHz - BW to 2 400 MHz):

- Change the centre frequency of the analyser to 2 399,5 MHz and perform the measurement for the first 1 MHz segment within range 2 400 MHz - BW to 2 400 MHz. Reduce the centre frequency in 1 MHz steps and repeat the measurements to cover this whole range. The centre frequency of the last 1 MHz segment shall be set to 2 400 MHz - BW + 0,5 MHz (which means this may partly overlap with the previous 1 MHz segment).

Step 5 (segment 2 400 MHz - 2BW to 2 400 MHz - BW):

- Change the centre frequency of the analyser to 2 399,5 MHz - BW and perform the measurement for the first 1 MHz segment within range 2 400 MHz - 2BW to 2 400 MHz - BW. Reduce the centre frequency in 1 MHz steps and repeat the measurements to cover this whole range. The centre frequency of the last 1 MHz segment shall be set to 2 400 MHz - 2BW + 0,5 MHz (which means this may partly overlap with the previous 1 MHz segment).

Step 6:

- In case of conducted measurements on equipment with a single transmit chain, the declared antenna assembly gain "G" in dBi shall be added to the results for each of the 1 MHz segments and compared with the limits

provided by the mask given in figure 1 or figure 3. If more than one antenna assembly is intended for this power setting, the antenna with the highest gain shall be considered.

- In case of conducted measurements on smart antenna systems (equipment with multiple transmit chains), the measurements need to be repeated for each of the active transmit chains. The declared antenna assembly gain "G" in dBi for a single antenna shall be added to these results. If more than one antenna assembly is intended for this power setting, the antenna with the highest gain shall be considered. Comparison with the applicable limits shall be done using any of the options given below:

- Option 1: the results for each of the transmit chains for the corresponding 1 MHz segments shall be added. The additional beamforming gain "Y" in dB shall be added as well and the resulting values compared with the limits provided by the mask given in figure 1 or figure 3.

- Option 2: the limits provided by the mask given in figure 1 or figure 3 shall be reduced by $10 \times \log_{10}(Ach)$ and the additional beamforming gain "Y" in dB. The results for each of the transmit chains shall be individually compared with these reduced limits.

NOTE 2: Ach refers to the number of active transmit chains.

It shall be recorded whether the equipment complies with the mask provided in figure 1 or figure 3.

11.4 Test Result

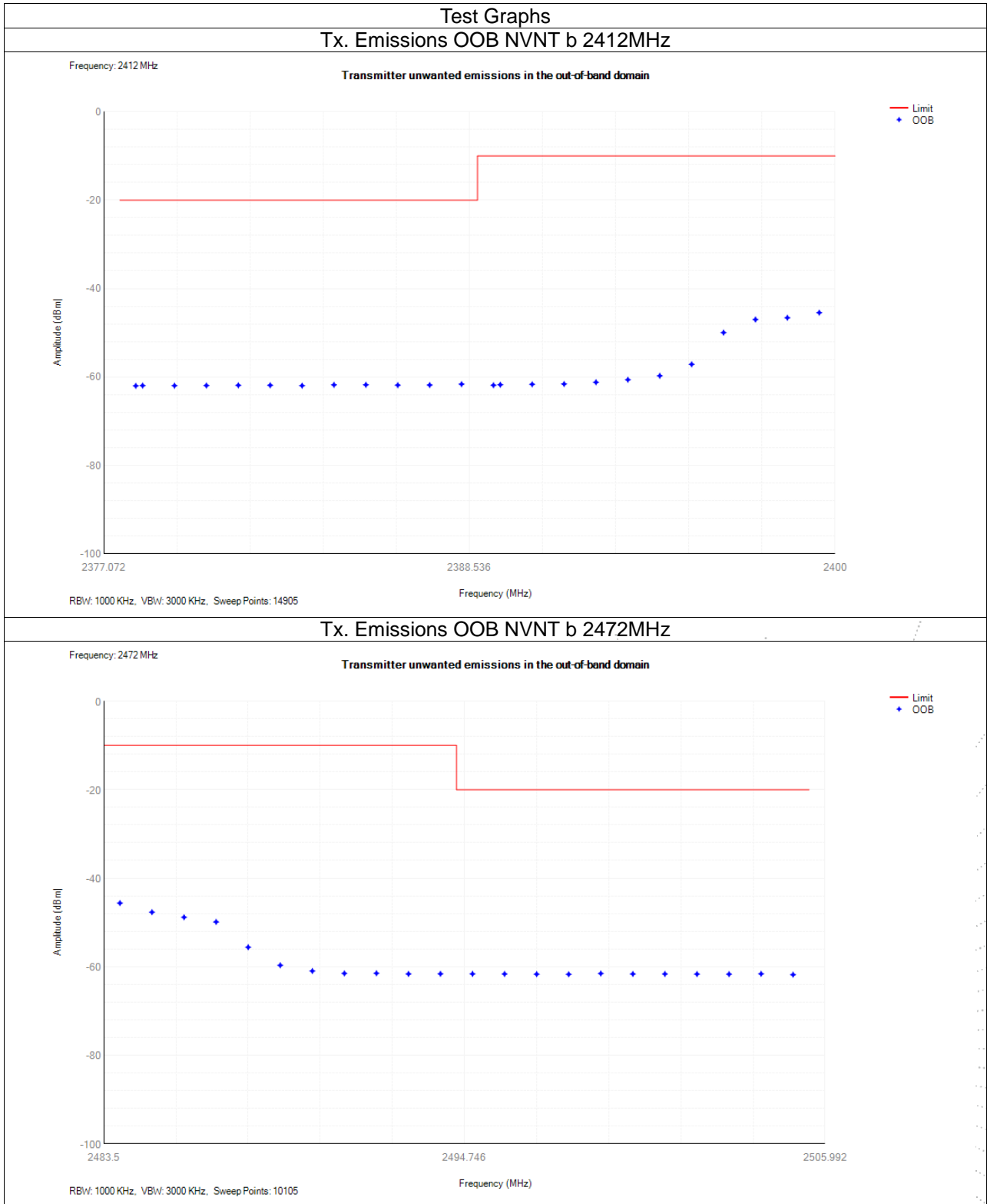

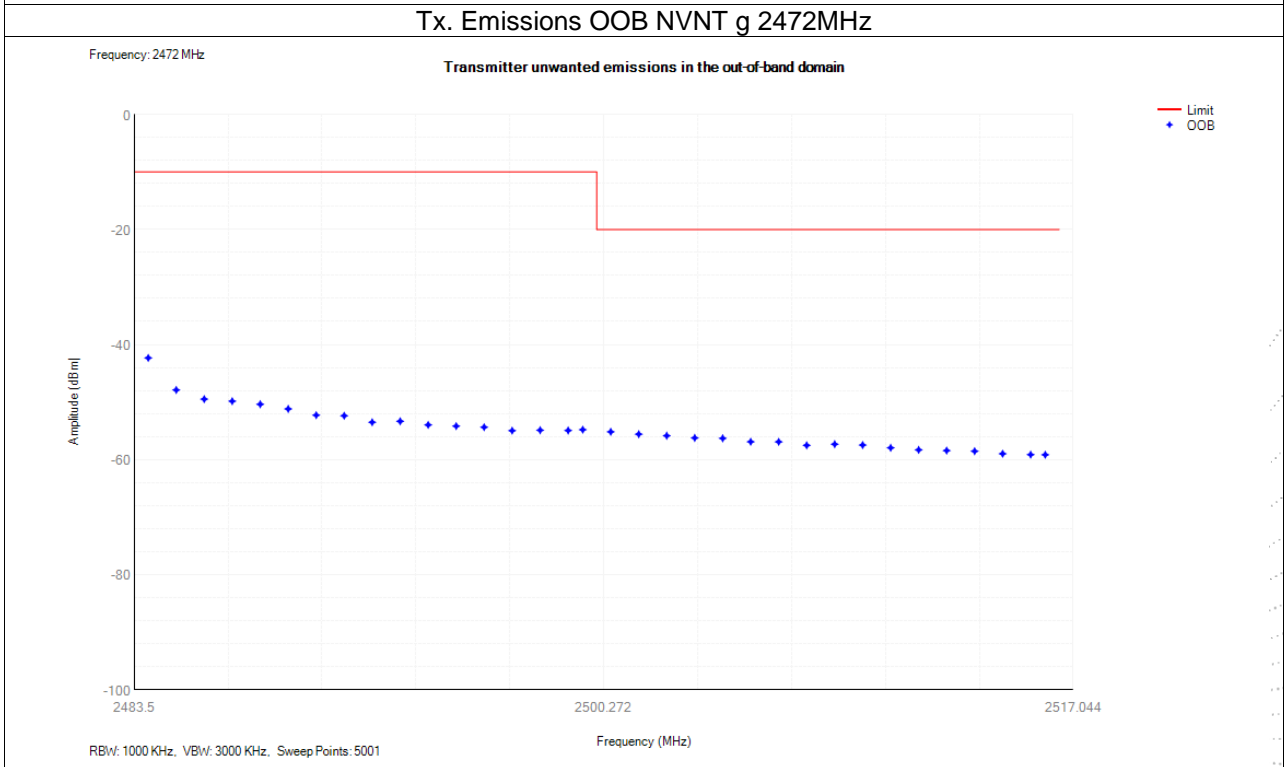
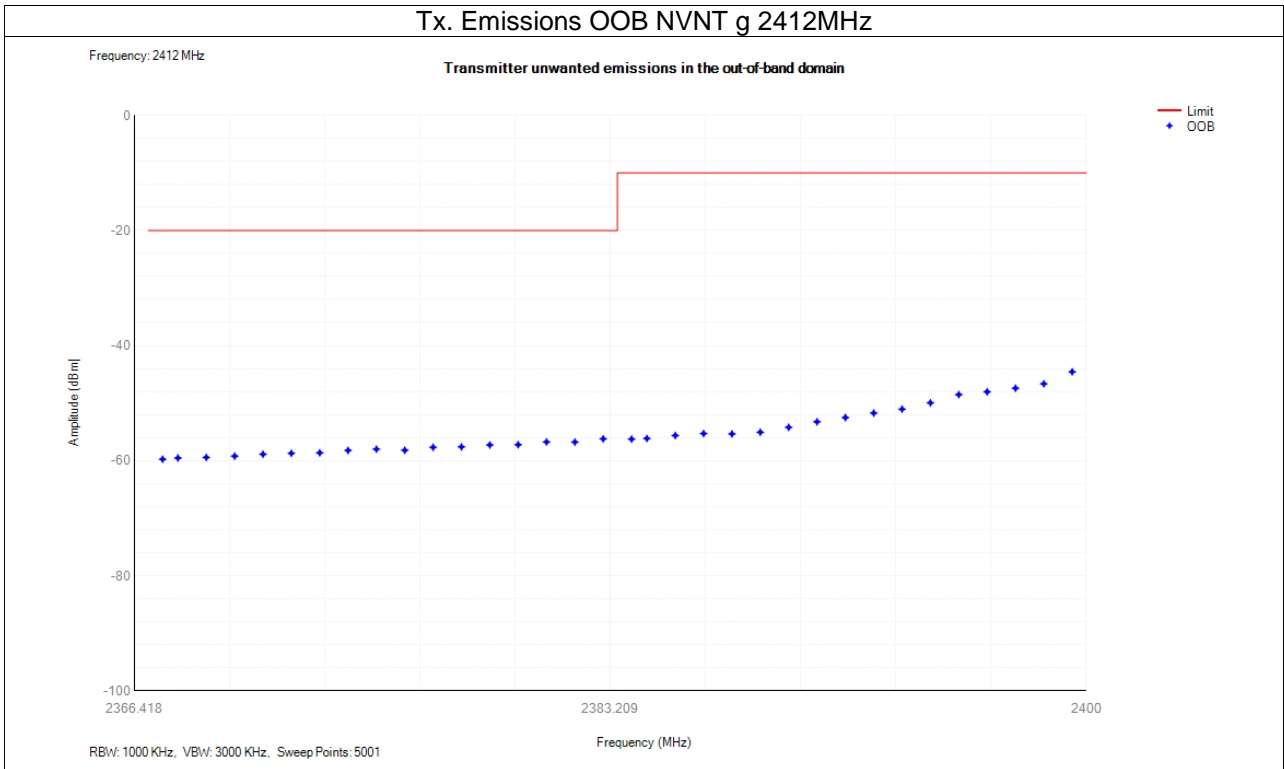

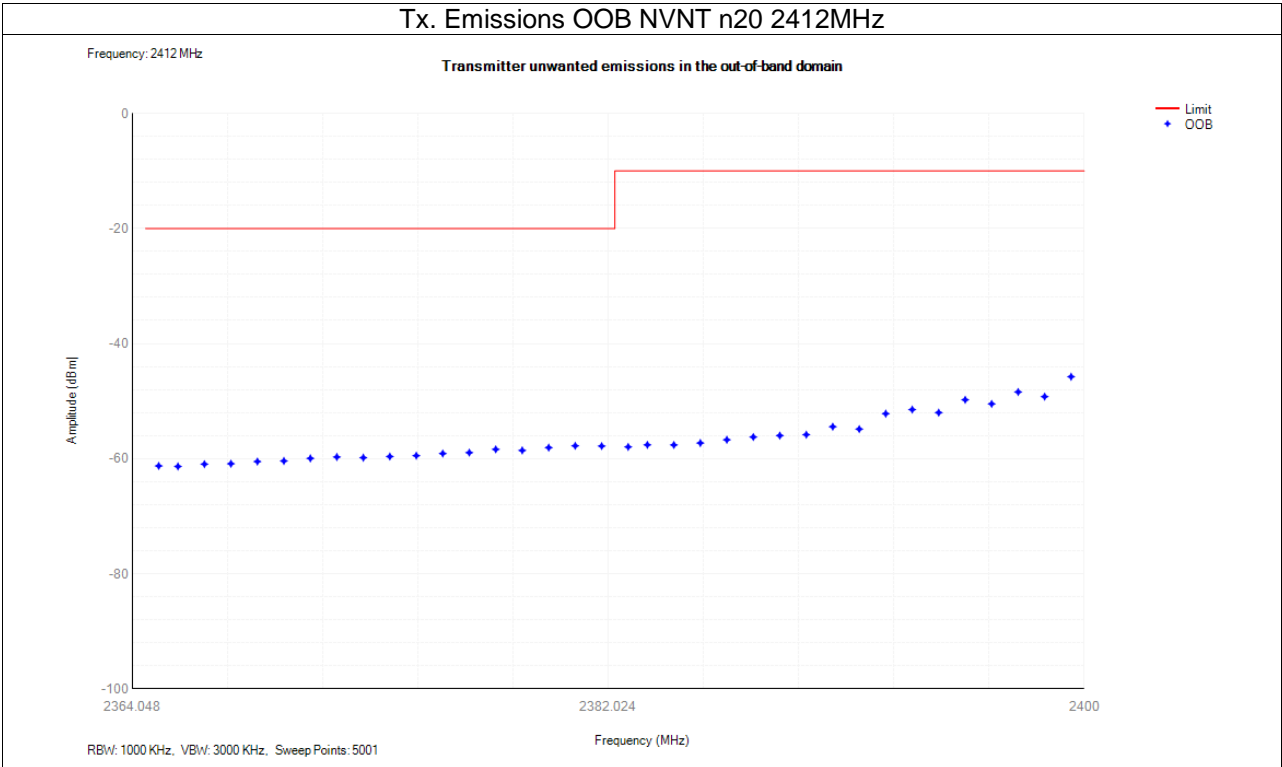
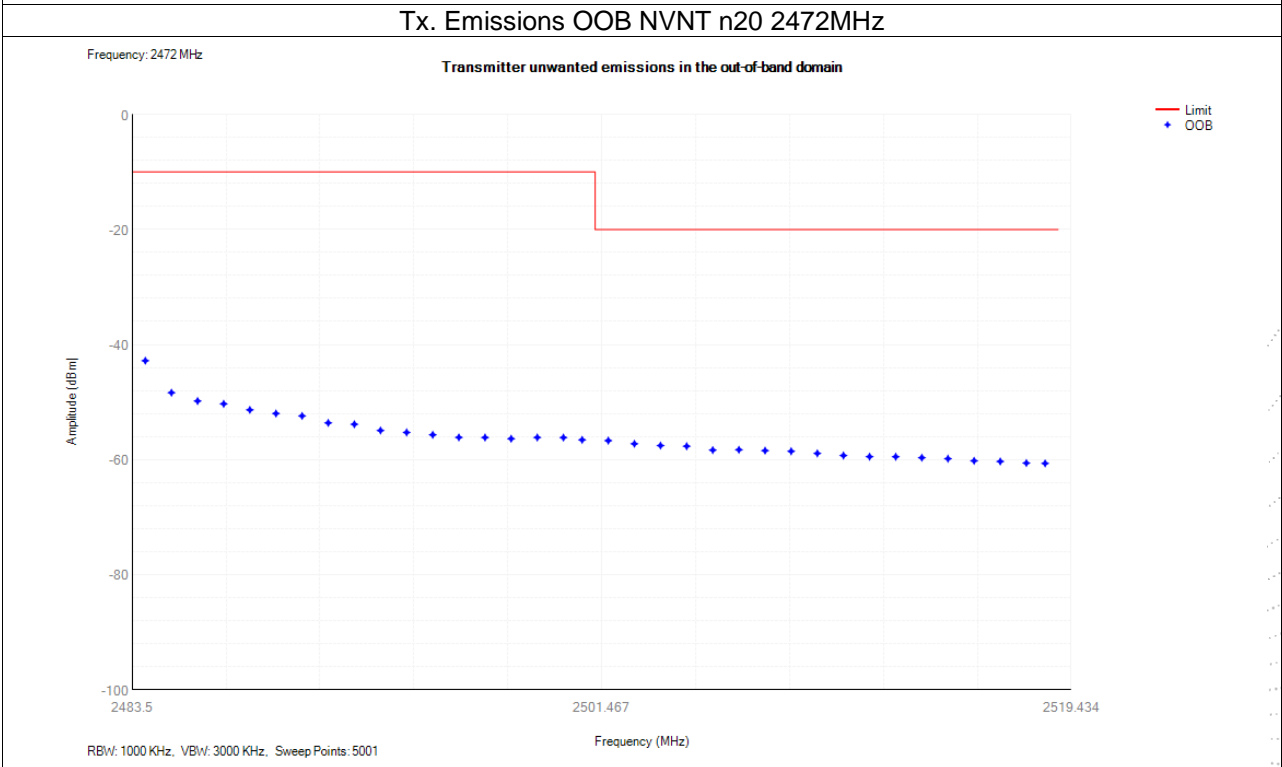
Tx. Emissions OOB NVNT n20 2412MHz

Tx. Emissions OOB NVNT n20 2472MHz

12. Transmitter Unwanted Emissions In The Spurious Domain

12.1 Block Diagram Of Test Setup

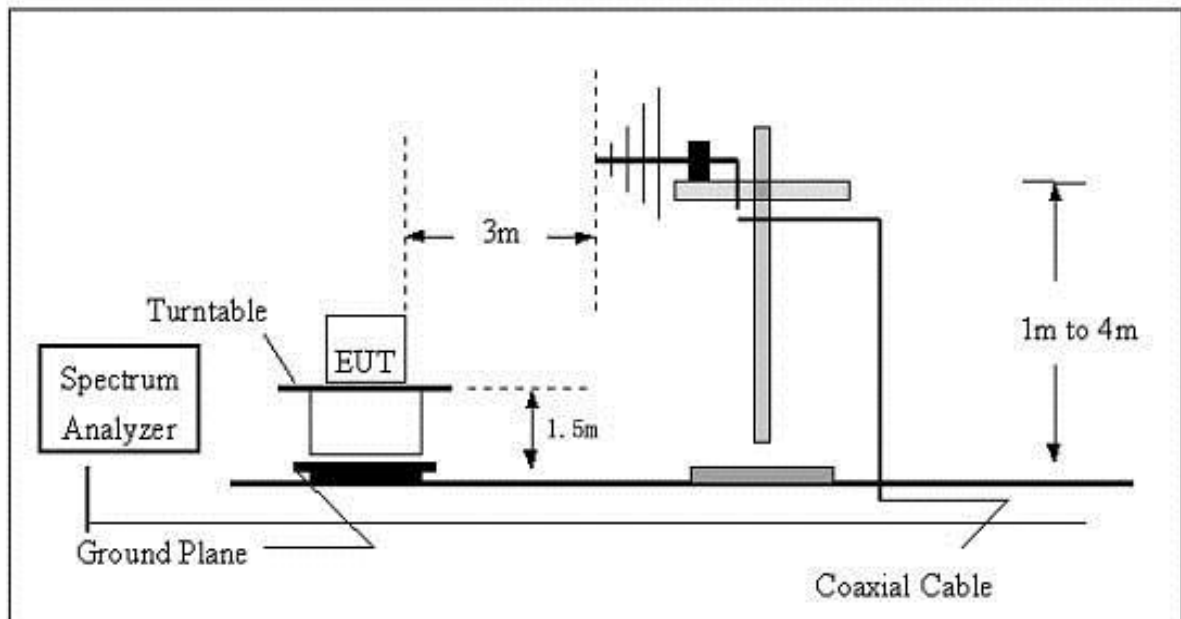
(A) Radiated Emission Test Set-Up, Frequency Below 1000MHz



(B) Radiated Emission Test Set-Up Frequency Above 1 GHz

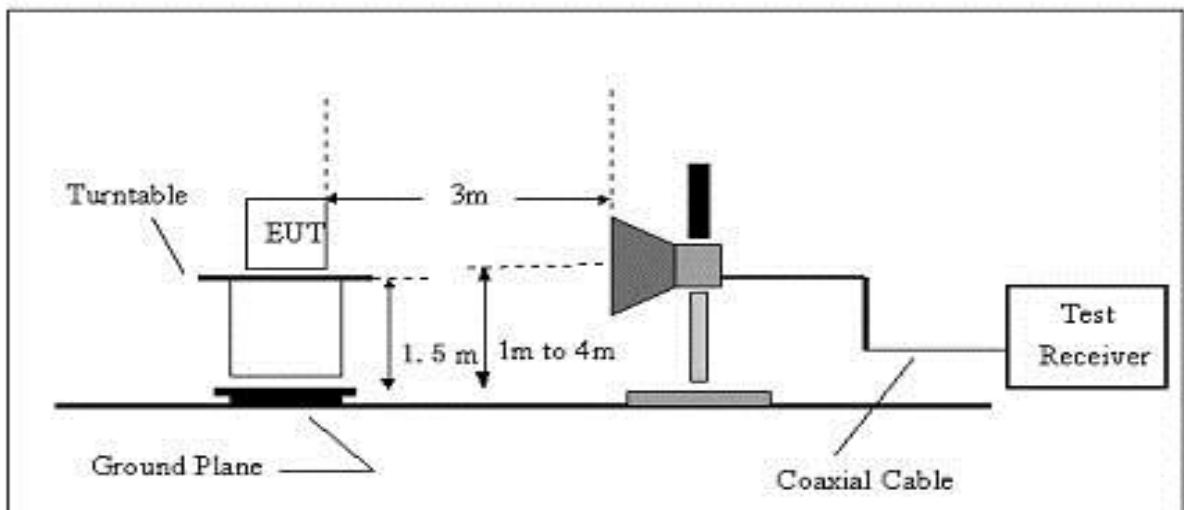

12.2 Limits

Frequency range	Maximum power, e.r.p. (≤ 1 GHz) e.i.r.p. (> 1 GHz)	Bandwidth
30 MHz to 47 MHz	-36 dBm	100 kHz/
47 MHz to 74 MHz	-54 dBm	100 kHz
74 MHz to 87,5 MHz	-36 dBm	100 kHz
87,5 MHz to 118 MHz	-54 dBm	100 kHz
118 MHz to 174 MHz	-36 dBm	100 kHz
174 MHz to 230 MHz	-54 dBm	100 kHz
230 MHz to 470 MHz	-36 dBm	100 kHz
470 MHz to 694 MHz	-54 dBm	100 kHz
694 MHz to 1 GHz	-36 dBm	100 kHz
1 GHz to 12,75 GHz	-30 dBm	1 MHz

12.3 Test Procedure

30MHz ~ 1GHz:

- The Product was placed on the nonconductive turntable 1.5m above the ground in a full anechoic chamber.
- Set the spectrum analyzer/receiver in Peak detector, Max Hold mode, and 120 kHz RBW. Record the maximum field strength of all the pre-scan process in the full band when the antenna is varied between 1~4 m in both horizontal and vertical, and the turntable is rotated from 0 to 360 degrees.
- For each frequency whose maximum record was higher or close to limit, measure its QP value: vary the antenna's height and rotate the turntable from 0 to 360 degrees to find the height and degree where Product radiated the maximum emission, then set the test frequency analyzer/receiver to QP Detector and specified bandwidth with Maximum Hold Mode, and record the maximum value.

Above 1GHz:

- The Product was placed on the non-conductive turntable 1.5 m above the ground in a full anechoic chamber..
- Set the spectrum analyzer/receiver in Peak detector, Max Hold mode, and 1MHz RBW. Record the maximum field strength of all the pre-scan process in the full band when the antenna is varied in both horizontal and vertical, and the turntable is rotated from 0 to 360 degrees.
- For each frequency whose maximum record was higher or close to limit, measure its AV value: rotate the turntable from 0 to 360 degrees to find the degree where Product radiated the maximum emission, then set the test frequency analyzer/receiver to AV value and specified bandwidth with Maximum Hold Mode, and record the maximum value.

12.4 Test Results

Modulation : 802.11b (the worst data)

Frequency	Receiver Reading	Turn table Angle	RX Antenna		Correct	Absolute Level	Result	
			Height	Polar	Factor		Limit	Margin
(MHz)	(dBm)	Degree	(m)	(H/V)	(dBm)	(dBm)	(dBm)	(dB)
802.11b Low channel								
535.10	-52.27	100	1.1	H	-8.06	-60.33	-54	-6.33
535.10	-53.03	247	1.8	V	-8.06	-61.08	-54	-7.08
4824.00	-43.18	33	1.5	H	-0.43	-43.61	-30	-13.61
4824.00	-43.53	205	1.3	V	-0.43	-43.96	-30	-13.96
7236.00	-55.01	29	1.3	H	8.31	-46.70	-30	-16.70
7236.00	-59.40	1	1.7	V	8.31	-51.09	-30	-21.09
802.11b Mid channel								
535.10	-51.95	198	2.0	H	-8.06	-60.01	-54	-6.01
535.10	-52.36	146	1.7	V	-8.06	-60.41	-54	-6.41
4884.00	-43.44	326	1.1	H	-0.38	-43.82	-30	-13.82
4884.00	-43.10	278	1.0	V	-0.38	-43.48	-30	-13.48
7326.00	-55.35	71	1.3	H	8.83	-46.52	-30	-16.52
7326.00	-58.79	172	2.0	V	8.83	-49.96	-30	-19.96
802.11b High channel								
535.10	-51.99	190	1.7	H	-8.06	-60.04	-54	-6.04
535.10	-53.23	151	2.0	V	-8.06	-61.28	-54	-7.28
4944.00	-42.29	305	1.3	H	-0.32	-42.61	-30	-12.61
4944.00	-43.50	232	1.4	V	-0.32	-43.82	-30	-13.82
7416.00	-55.21	220	1.4	H	9.35	-45.86	-30	-15.86
7416.00	-58.69	29	1.9	V	9.35	-49.34	-30	-19.34

Remark:

Absolute Level = Receiver Reading + Factor

Factor = Antenna Factor + Cable Loss – Pre-amplifier.

13. Receiver Spurious Emissions

13.1 Block Diagram Of Test Setup

(A) Radiated Emission Test Set-Up, Frequency Below 1000MHz

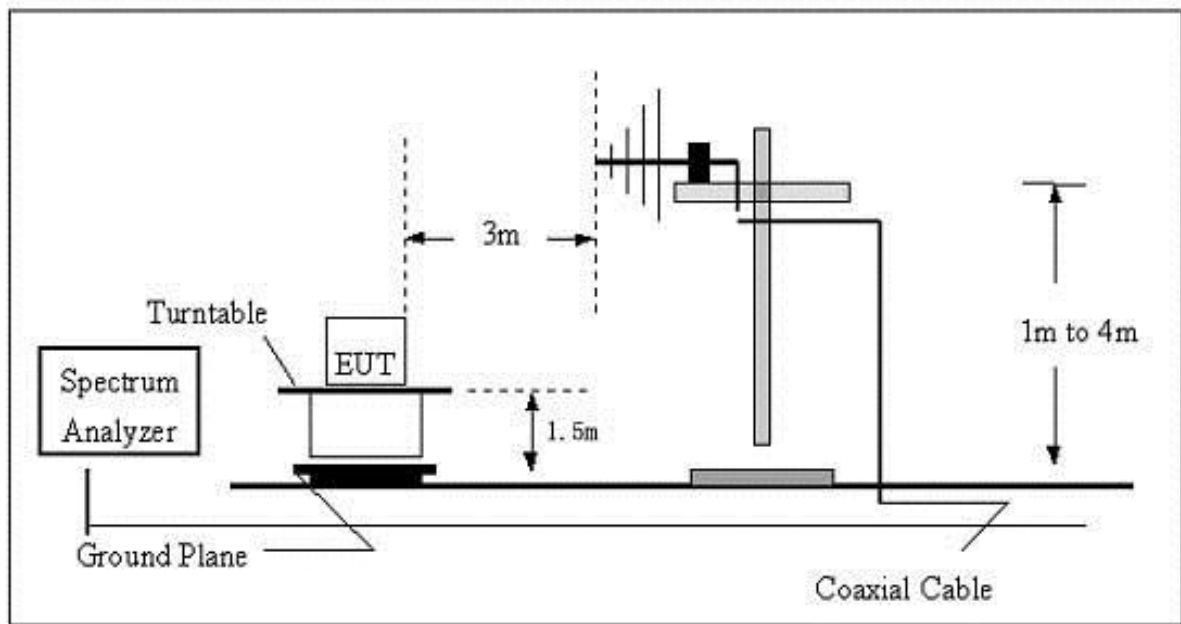

(B) Radiated Emission Test Set-Up Frequency Above 1 GHz

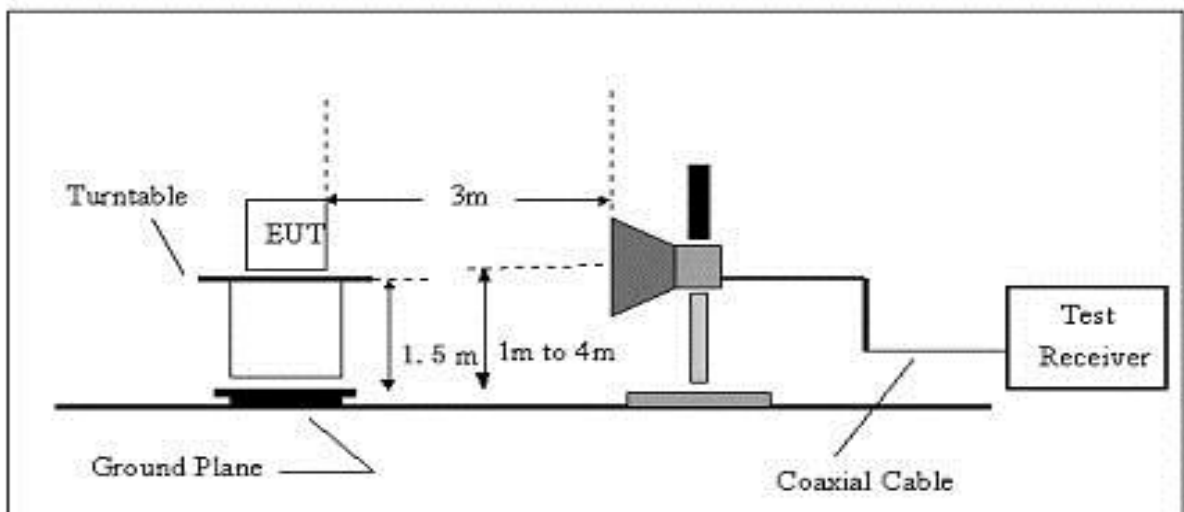

13.2 Limits

Frequency(MHz)	Limit	Bandwidth
30-1000	-57dBm	100 kHz
1000-12750	-47dBm	1 MHz

13.3 Test Procedure

30MHz ~ 1GHz:

- The Product was placed on the nonconductive turntable 1.5m above the ground in a full anechoic chamber.
- Set the spectrum analyzer/receiver in Peak detector, Max Hold mode, and 120 kHz RBW. Record the maximum field strength of all the pre-scan process in the full band when the antenna is varied between 1~4 m in both horizontal and vertical, and the turntable is rotated from 0 to 360 degrees.
- For each frequency whose maximum record was higher or close to limit, measure its QP value: vary the antenna's height and rotate the turntable from 0 to 360 degrees to find the height and degree where Product radiated the maximum emission, then set the test frequency analyzer/receiver to QP Detector and specified bandwidth with Maximum Hold Mode, and record the maximum value.

Above 1GHz:

- The Product was placed on the non-conductive turntable 1.5 m above the ground in a full anechoic chamber..
- Set the spectrum analyzer/receiver in Peak detector, Max Hold mode, and 1MHz RBW. Record the maximum field strength of all the pre-scan process in the full band when the antenna is varied in both horizontal and vertical, and the turntable is rotated from 0 to 360 degrees.
- For each frequency whose maximum record was higher or close to limit, measure its AV value: rotate the turntable from 0 to 360 degrees to find the degree where Product radiated the maximum emission, then set the test frequency analyzer/receiver to AV value and specified bandwidth with Maximum Hold Mode, and record the maximum value.

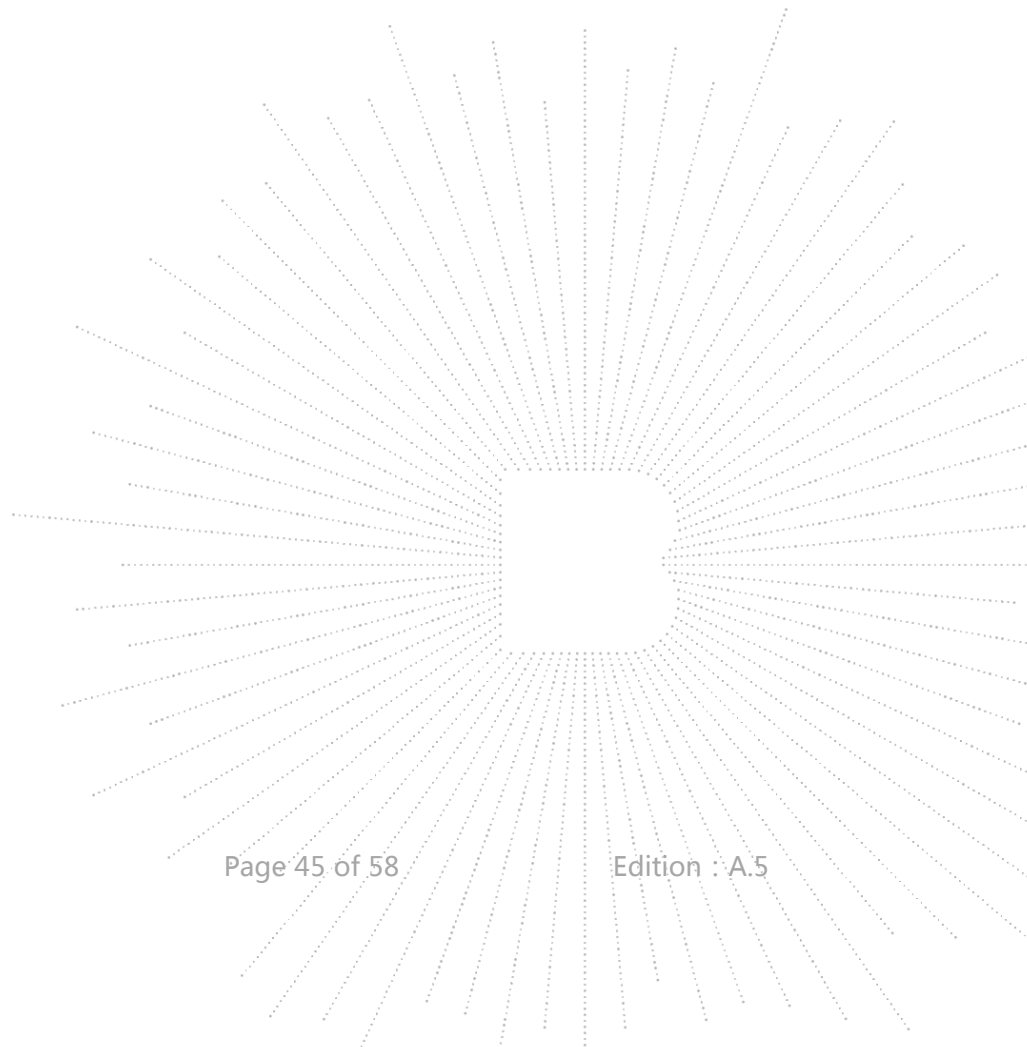

13.4 Test Results

Modulation : 802.11b (the worst data)

Frequency (MHz)	Receiver Reading (dBm)	Turn table Angle Degree	RX Antenna		Correct	Absolute Level (dBm)	Result	
			Height (m)	Polar (H/V)	Factor (dBm)		Limit (dBm)	Margin (dB)
802.11b Low channel								
233.58	-48.72	262	1.4	H	-15.66	-64.38	-57.00	-7.38
233.58	-54.77	87	1.3	V	-15.66	-70.43	-57.00	-13.43
2395.65	-49.82	40	1.0	H	-6.70	-56.53	-47.00	-9.53
2395.65	-50.54	68	1.5	V	-6.70	-57.24	-47.00	-10.24
802.11b Mid channel								
233.58	-49.44	11	1.5	H	-15.66	-65.10	-57.00	-8.10
233.58	-54.57	336	1.4	V	-15.66	-70.22	-57.00	-13.22
2395.65	-50.30	245	1.5	H	-6.70	-57.01	-47.00	-10.01
2395.65	-51.03	196	1.8	V	-6.70	-57.73	-47.00	-10.73
802.11b High channel								
233.58	-49.30	82	1.1	H	-15.66	-64.96	-57.00	-7.96
233.58	-54.11	119	1.6	V	-15.66	-69.77	-57.00	-12.77
2395.65	-49.56	225	2.0	H	-6.70	-56.27	-47.00	-9.27
2395.65	-50.15	176	2.0	V	-6.70	-56.85	-47.00	-9.85

Remark:

$$\text{Absolute Level} = \text{Receiver Reading} + \text{Factor}$$

$$\text{Factor} = \text{Antenna Factor} + \text{Cable Loss} - \text{Pre-amplifier.}$$

14. Receiver Blocking

14.1 Block Diagram Of Test Setup

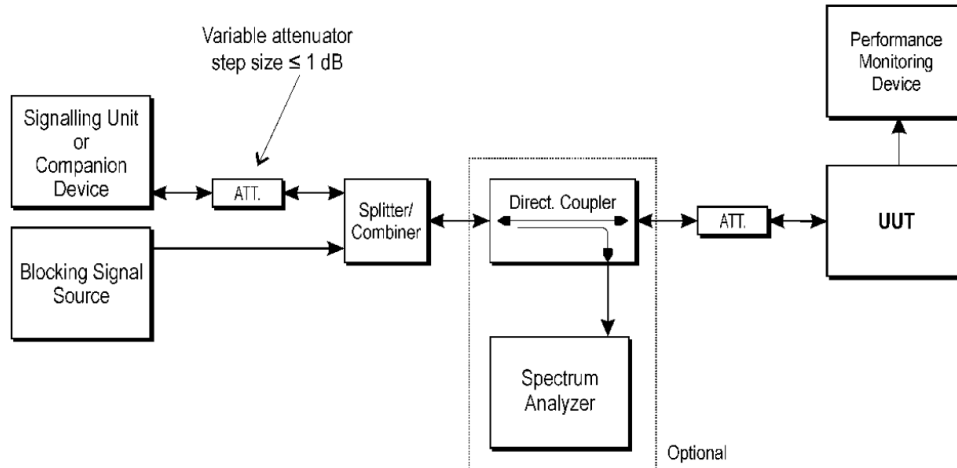

14.2 Limit

Table 6: Receiver Blocking parameters for Receiver Category 1 equipment

Wanted signal mean power from companion device (dBm) (see notes 1 and 4)	Blocking signal frequency (MHz)	Blocking signal power (dBm) (see note 4)	Type of blocking signal
$(-133 \text{ dBm} + 10 \times \log_{10}(\text{OCBW}))$ or -68 dBm whichever is less (see note 2)	2 380 2 504	-34	CW
$(-139 \text{ dBm} + 10 \times \log_{10}(\text{OCBW}))$ or -74 dBm whichever is less (see note 3)	2 300 2 330 2 360 2 524 2 584 2 674		
NOTE 1: OCBW is in Hz. NOTE 2: In case of radiated measurements using a companion device and the level of the wanted signal from the companion device cannot be determined, a relative test may be performed using a wanted signal up to $P_{\min} + 26 \text{ dB}$ where P_{\min} is the minimum level of wanted signal required to meet the minimum performance criteria as defined in clause 4.3.1.12.3 in the absence of any blocking signal. NOTE 3: In case of radiated measurements using a companion device and the level of the wanted signal from the companion device cannot be determined, a relative test may be performed using a wanted signal up to $P_{\min} + 20 \text{ dB}$ where P_{\min} is the minimum level of wanted signal required to meet the minimum performance criteria as defined in clause 4.3.1.12.3 in the absence of any blocking signal. NOTE 4: The level specified is the level at the UUT receiver input assuming a 0 dBi antenna assembly gain. In case of conducted measurements, this level has to be corrected for the (in-band) antenna assembly gain (G). In case of radiated measurements, this level is equivalent to a power flux density (PFD) in front of the UUT antenna with the UUT being configured/positioned as recorded in clause 5.4.3.2.2.			

14.3 Test procedure

Refer to ETSI EN 300 328 V2.2.2 (2019-07) Clause 5.4.11.2.

14.4 Test Result

Modulation : 802.11b (the worst data)

Receiver Category 1					
802.11b	P _{min} (dBm)	Blocking Frequency(MHz)	Blocking Power(dB)	Measured PER(%)	Limit (%)
2412	-68	2380	-34	3.12	10
2412	-74	2300	-34	2.86	10
2412	-74	2330	-34	1.77	10
2412	-74	2360	-34	3.20	10
2472	-68	2504	-34	3.55	10
2472	-74	2524	-34	1.68	10
2472	-74	2584	-34	2.82	10
2472	-74	2674	-34	1.33	10

Note: This report only shows the worst case test data.
 OCBW=11214000Hz
 $(-133\text{dBm}+10*\log_{10}(\text{OCBW}))=-62.50\text{dBm}$
 $-68\text{dBm}\leq-62.50\text{dBm}$
 Wanted Signal Power=-68dBm
 $(-139\text{dBm}+10*\log_{10}(\text{OCBW}))=-68.50\text{dBm}$
 $-74\text{dBm}\leq-68.50\text{dBm}$
 Wanted Signal Power=-74dBm

15. EUT Photographs

EUT Photo 1

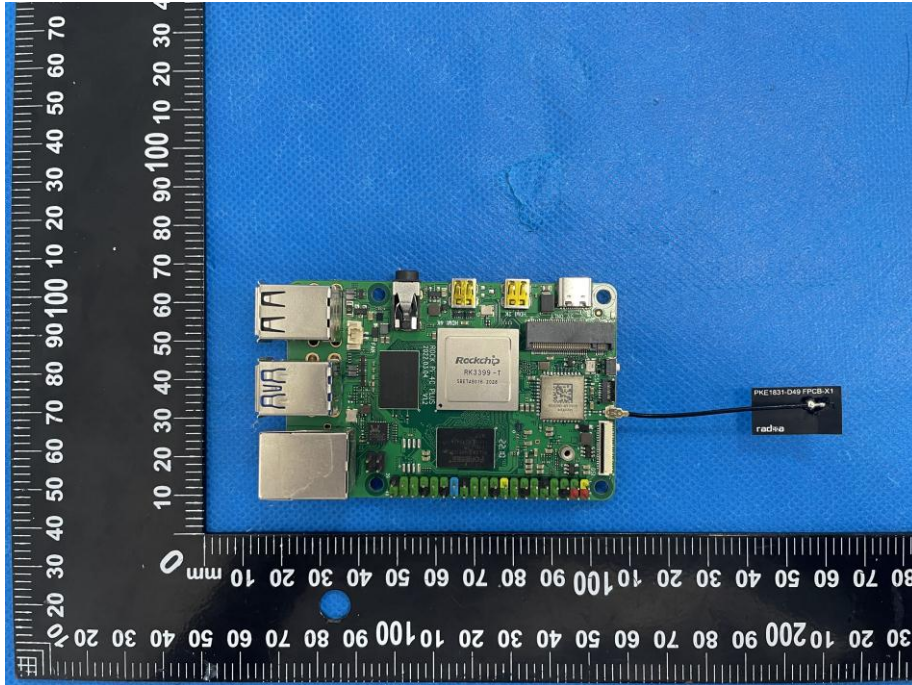

EUT Photo 2

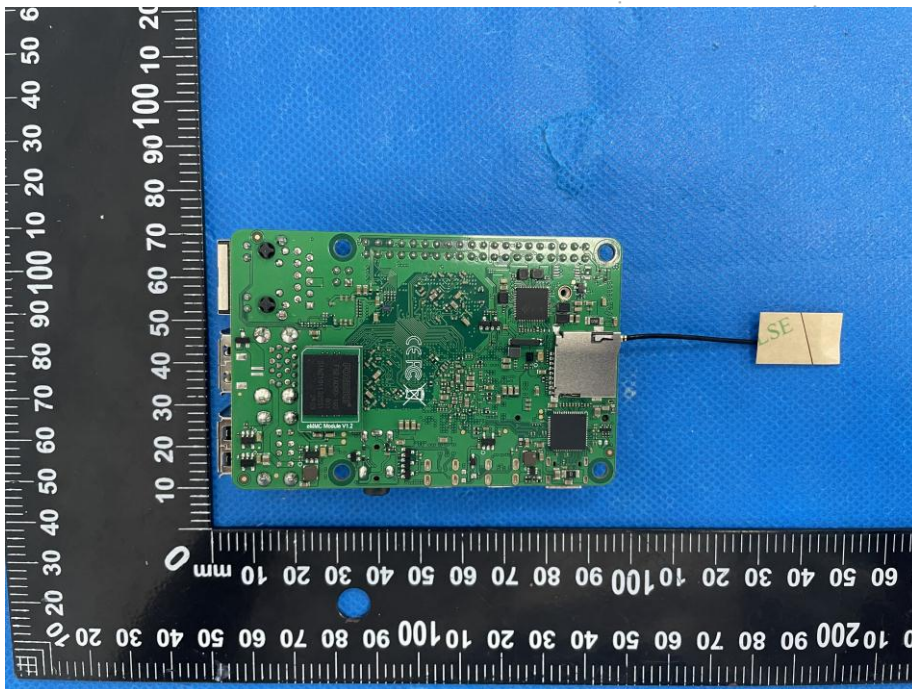

EUT Photo 3

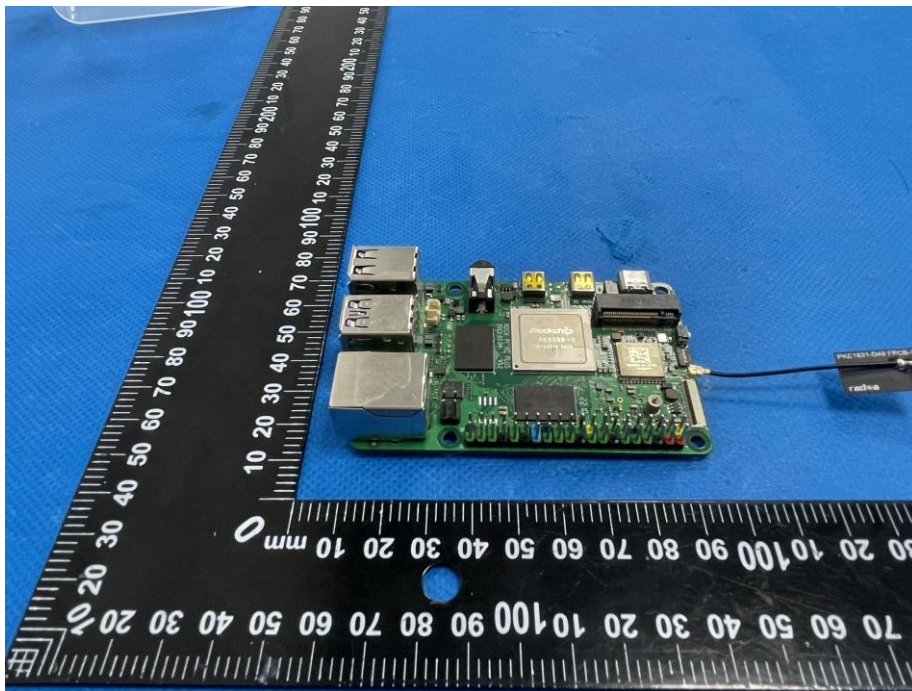

EUT Photo 4

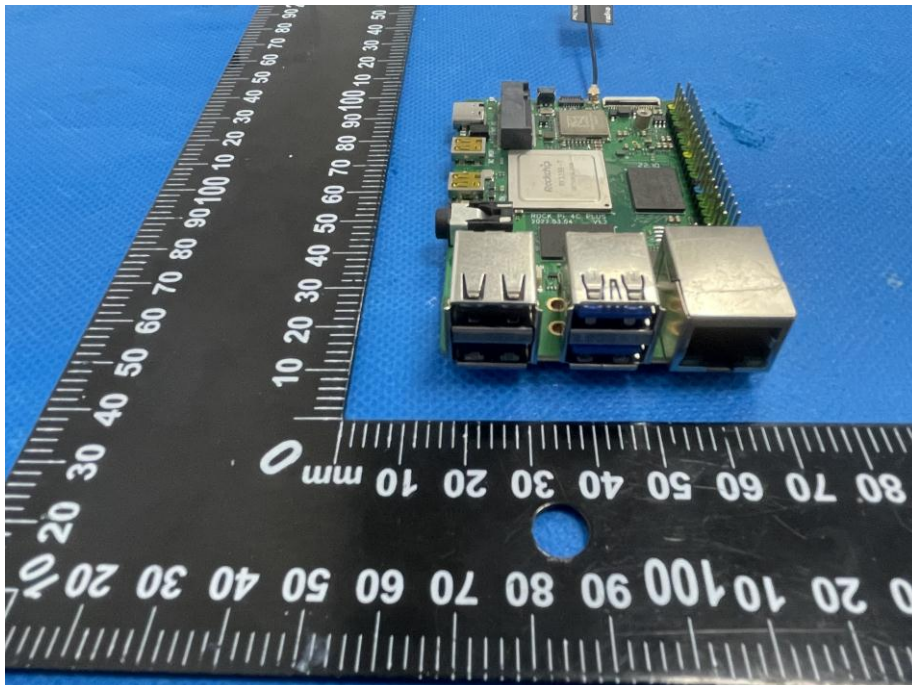

EUT Photo 5

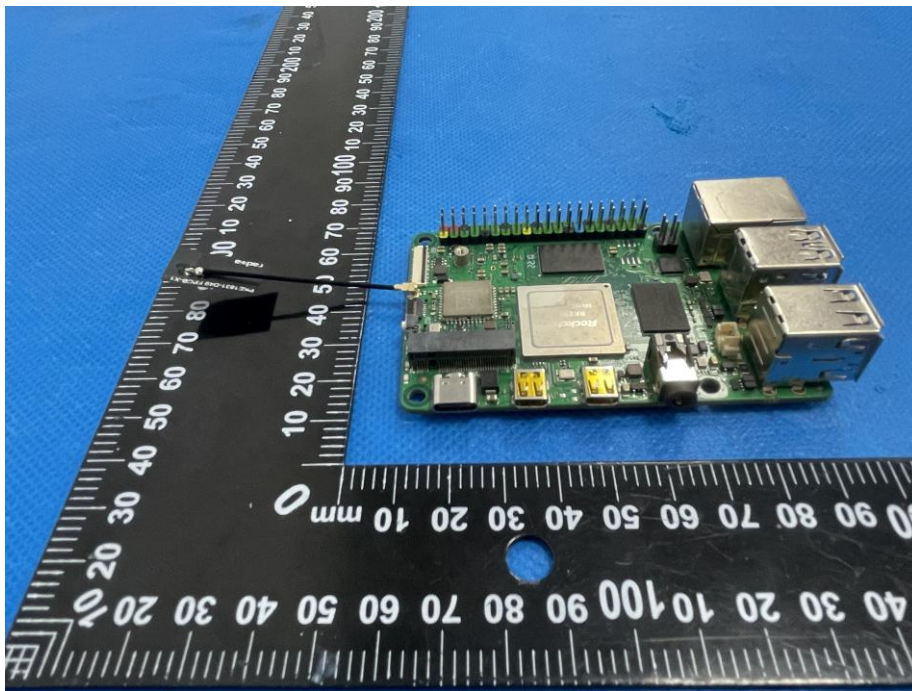

EUT Photo 6

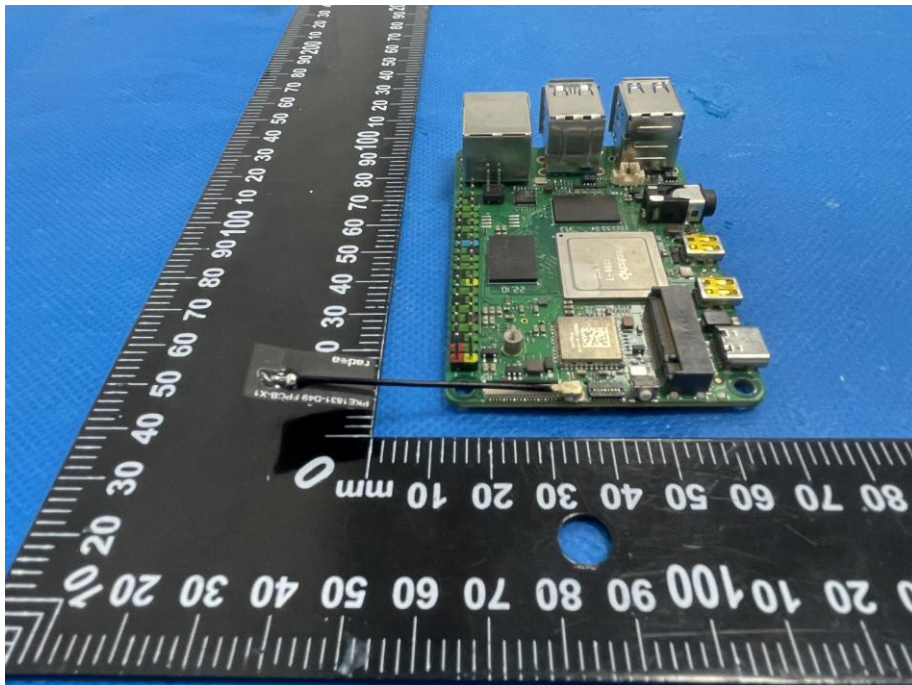

EUT Photo 7

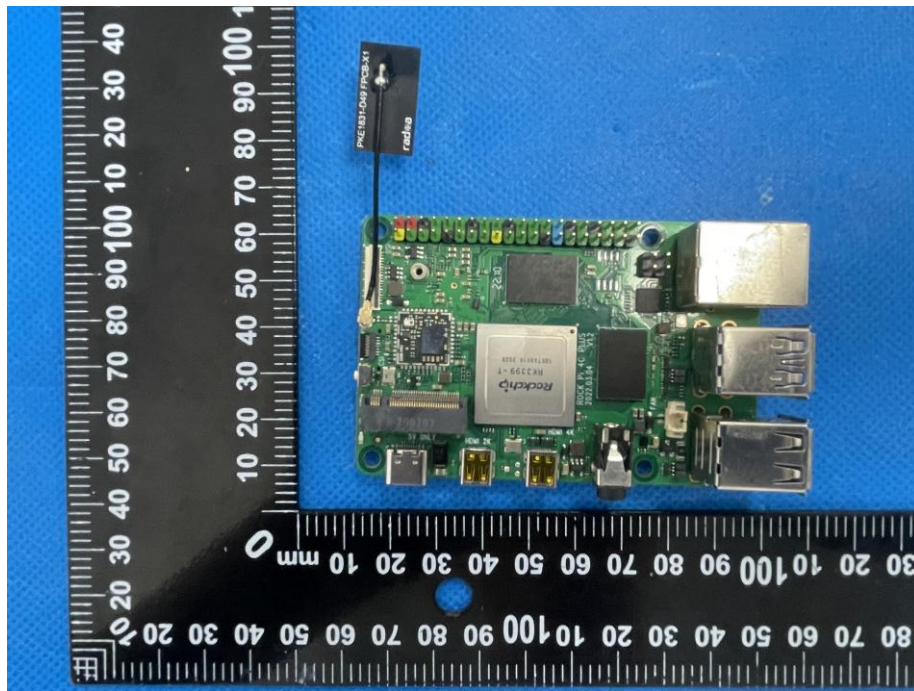

EUT Photo 8

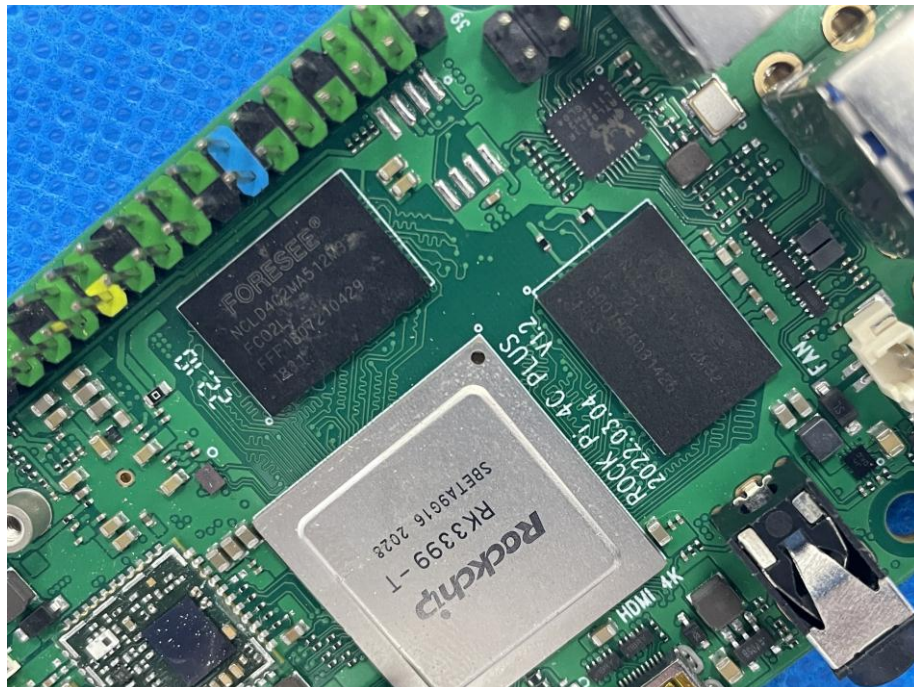

EUT Photo 9



EUT Photo 10

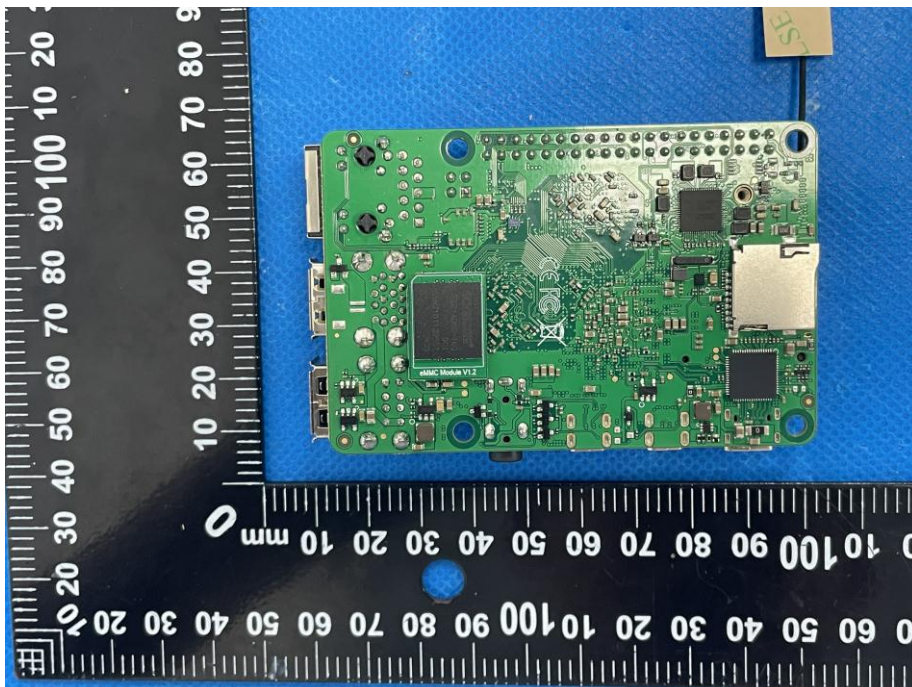

EUT Photo 11

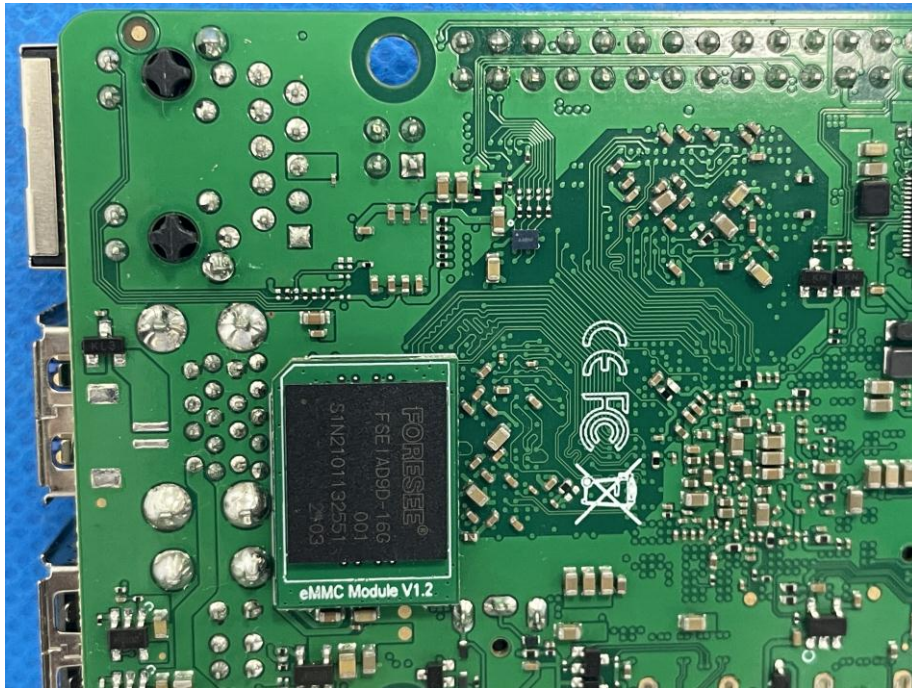

EUT Photo 12

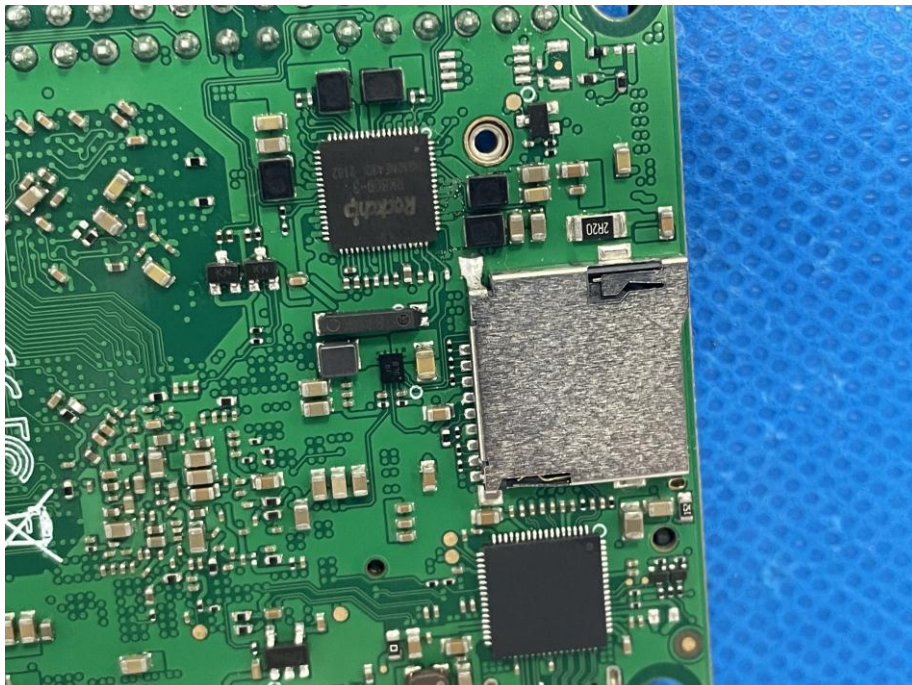

EUT Photo 13

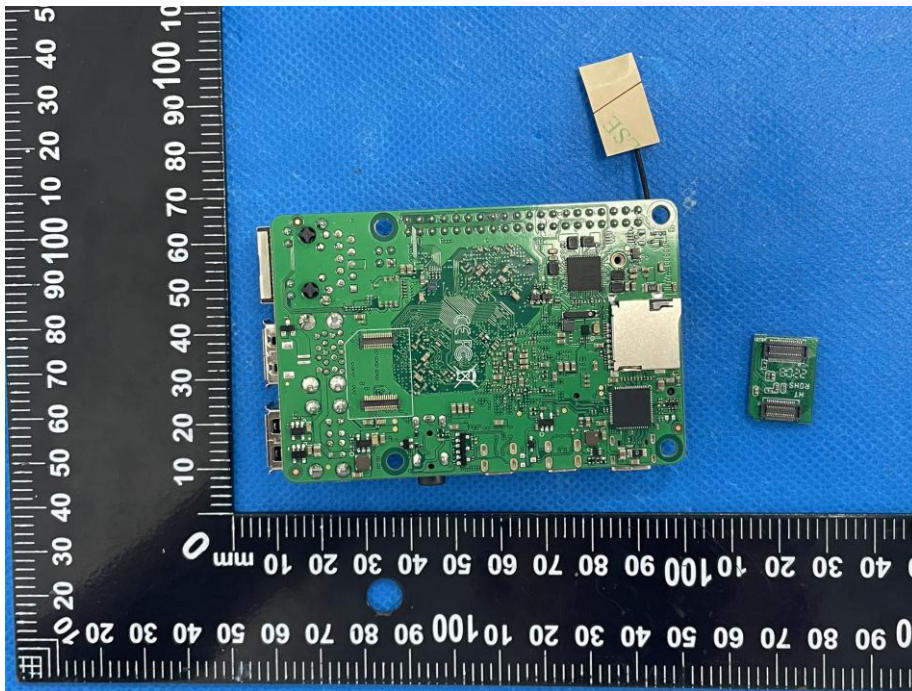

EUT Photo 14

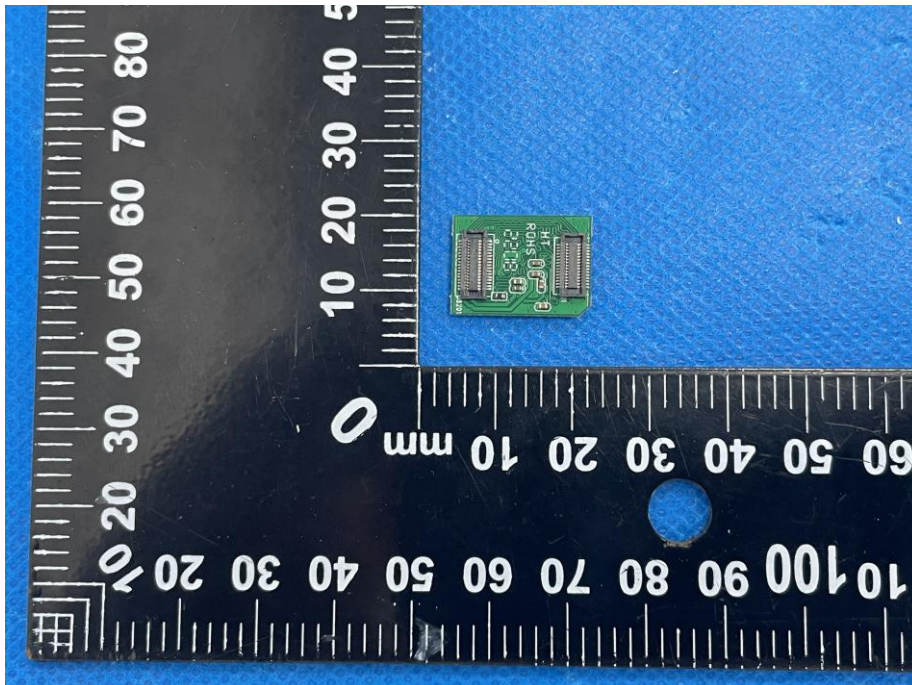

EUT Photo 15

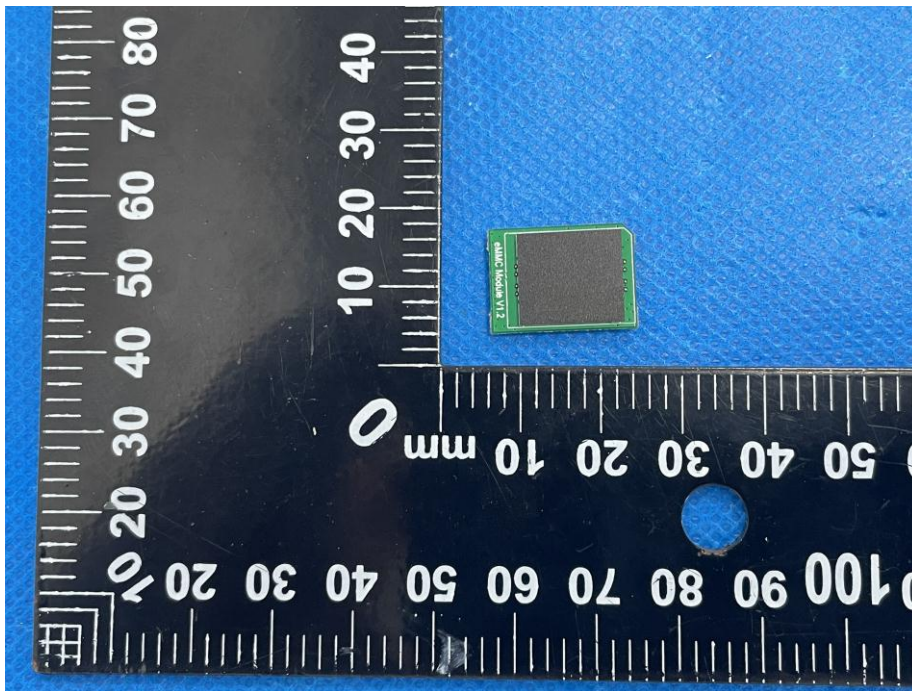

EUT Photo 16



16. EUT Test Setup Photographs

Spurious emissions



STATEMENT

1. The equipment lists are traceable to the national reference standards.
2. The test report can not be partially copied unless prior written approval is issued from our lab.
3. The test report is invalid without the "special seal for inspection and testing".
4. The test report is invalid without the signature of the approver.
5. The test process and test result is only related to the Unit Under Test.
6. Sample information is provided by the client and the laboratory is not responsible for its authenticity.
7. The test report without CMA mark is only used for scientific research, teaching, enterprise product development and internal quality control purposes.
8. The quality system of our laboratory is in accordance with ISO/IEC17025.
9. If there is any objection to this test report, the client should inform issuing laboratory within 15 days from the date of receiving test report.

Address:

1-2/F., Building B, Pengzhou Industrial Park, No.158, Fuyuan 1st Road, Zhancheng, Fuhai Subdistrict, Bao'an District, Shenzhen, Guangdong, China

TEL : 400-788-9558

P.C.: 518103

FAX : 0755-33229357

Website : <http://www.chnbctc.com>

E-Mail : bctc@bctc-lab.com.cn

***** END *****