

TEST REPORT

Report No.: BCTC2111530025-3E

Applicant: ROCKPI TRADING LIMITED

Product Name: Radxa Zero

Model/Type Ref.: D4E16H

Tested Date: 2021-11-05 to 2021-11-24

Issued Date: 2021-12-08

Shenzhen **BCTC** Testing Co., Ltd.



Product Name: Radxa Zero
Trademark: N/A
Model/Type Ref.: D4E16H
D4E16T, D4E32H, D4E64H, D4E128H
Prepared For: ROCKPI TRADING LIMITED
Address: Room 11, 27/f, Ga wah international centre, 191 Javaroad, north point, Hong Kong, China
Manufacturer: ROCKPI TRADING LIMITED
Address: Room 11, 27/f, Ga wah international centre, 191 Javaroad, north point, Hong Kong, China
Prepared By: Shenzhen BCTC Testing Co., Ltd.
Address: 1-2/F., Building B, Pengzhou Industrial Park, No.158, Fuyuan 1st Road, Tangwei, Fuhai Subdistrict, Bao'an District, Shenzhen, Guangdong, China
Sample Received Date: 2021-11-05
Sample tested Date: 2021-11-05 to 2021-11-24
Issue Date: 2021-12-08
Report No.: BCTC2111530025-3E
Test Standards: ETSI EN 300 328 V2.2.2 (2019-07)
Test Results: PASS
Remark: This is RED Radio test report

Tested by:



Lei Chen/Project Handler

Approved by:



Zero Zhou/Reviewer

The test report is effective only with both signature and specialized stamp. This result(s) shown in this report refer only to the sample(s) tested. Without written approval of Shenzhen BCTC Testing Co., Ltd, this report can't be reproduced except in full. The tested sample(s) and the sample information are provided by the client.

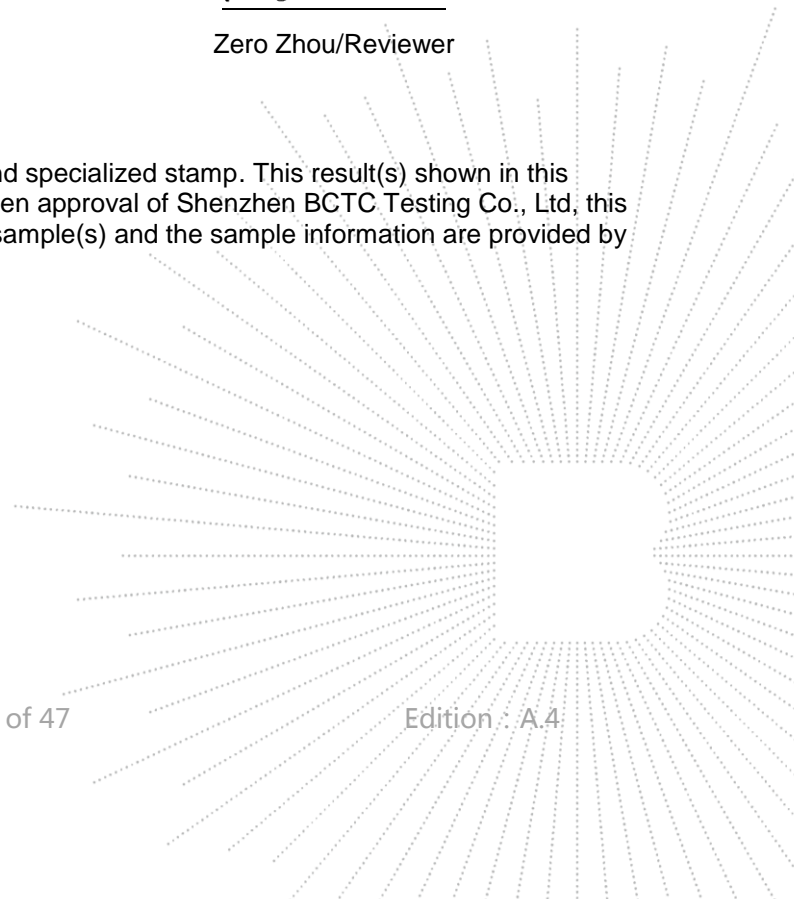
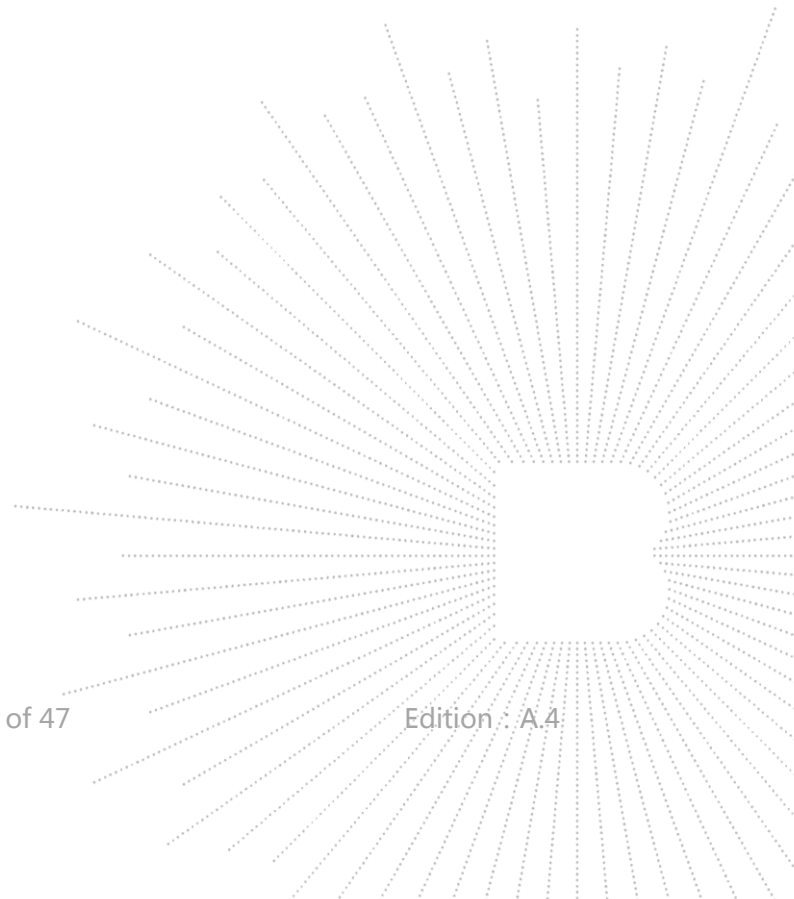

Table Of Content

Test Report Declaration	Page
1. Version	5
2. Test Summary	6
3. Measurement Uncertainty	7
4. Product Information And Test Setup	8
4.1 Product Information	8
4.2 Test Setup Configuration	8
4.3 Support Equipment	8
4.4 Channel List	9
4.5 Test Mode	9
4.6 Test Environment	9
5. Test Facility And Test Instrument Used	10
5.1 Test Facility	10
5.2 Test Instrument Used	10
6. Information As Required	11
7. RF Output Power	14
7.1 Block Diagram Of Test Setup	14
7.2 Limit	14
7.3 Test Procedure	14
7.4 Test Result	16
8. Accumulated Transmit Time, Minimum Frequency Occupation And Hopping Sequence	18
8.1 Block Diagram Of Test Setup	18
8.2 Limit	18
8.3 Test Procedure	19
8.4 Test Result	20
9. Hopping Frequency Separation	21
9.1 Block Diagram Of Test Setup	21
9.2 Limit	21
9.3 Test Procedure	21
9.4 Test Result	23
10. Occupied Channel Bandwidth	24
10.1 Block Diagram Of Test Setup	24
10.2 Limit	24
10.3 Test Procedure	24
10.4 Test Result	25
11. Transmitter Unwanted Emissions In The Out-Of-Band Domain	29
11.1 Block Diagram Of Test Setup	29
11.2 Limit	29

11.3	Test Procedure	29
11.4	Test Result	31
12.	Transmitter Unwanted Emissions In The Spurious Domain	34
12.1	Block Diagram Of Test Setup	34
12.2	Limits	35
12.3	Test Procedure	35
12.4	Test Results	36
13.	Receiver Spurious Emissions	37
13.1	Block Diagram Of Test Setup	37
13.2	Limits	37
13.3	Test Procedure	38
13.4	Test Results	39
14.	Receiver Blocking	40
14.1	Block Diagram Of Test Setup	40
14.2	Limit	40
14.3	Test Procedure	41
14.4	Test Result	41
15.	EUT Photographs	42
16.	EUT Test Setup Photographs	46

(Note: N/A Means Not Applicable)



1. Version

Report No.	Issue Date	Description	Approved
BCTC2111530025-3E	2021-12-08	Original	Valid

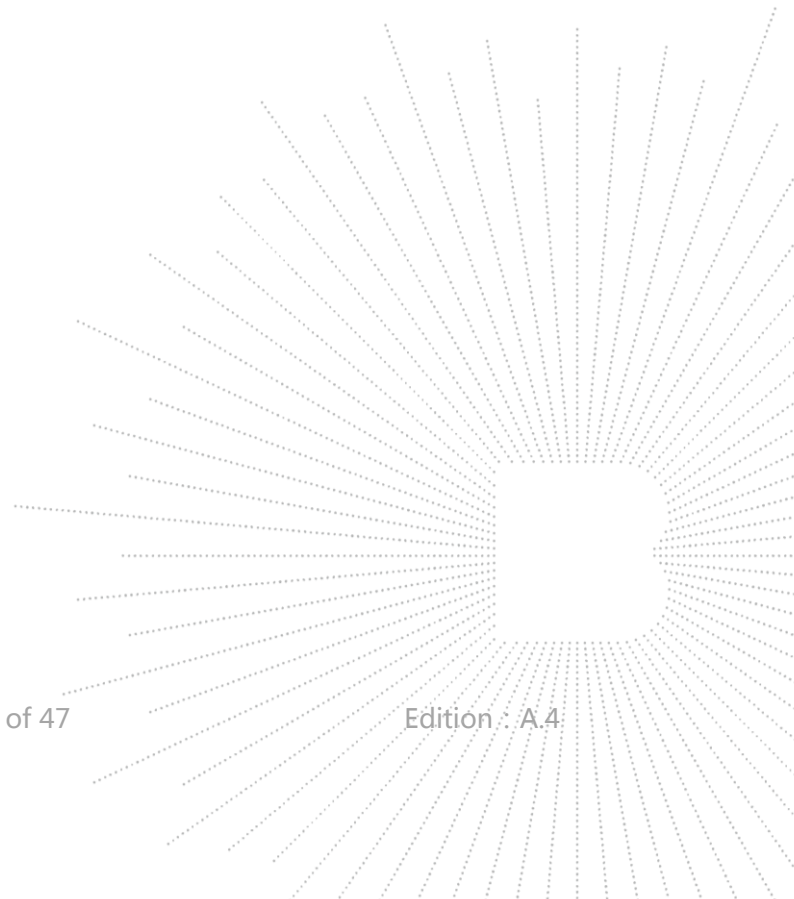

2. Test Summary

The Product has been tested according to the following specifications:

No.	Test Parameter	Clause No	Results
Transmitter Parameters			
1	RF output power	4.3.1.2	PASS
2	Duty Cycle, TX-sequence, TX-gap	4.3.1.3	N/A
3	Accumulated Transmit Time, Frequency Occupation and Hopping Sequence	4.3.1.4	PASS
4	Hopping Frequency Separation	4.3.1.5	PASS
5	Medium Utilization (MU) factor	4.3.1.6	N/A
6	Adaptivity (Adaptive Frequency Hopping)	4.3.1.7	N/A
7	Occupied Channel Bandwidth	4.3.1.8	PASS
8	Transmitter unwanted emissions in the out-of-band domain	4.3.1.9	PASS
10	Transmitter unwanted emissions in the spurious domain	4.3.1.10	PASS
Receiver Parameters			
11	Receiver spurious emissions	4.3.1.11	PASS
12	Receiver Blocking	4.3.1.12	PASS
13	Geo-location Capability	4.3.1.13	N/A

Note: N/A is an abbreviation for Not Applicable and means this test item is not applicable for this device according to the technology characteristic of device.

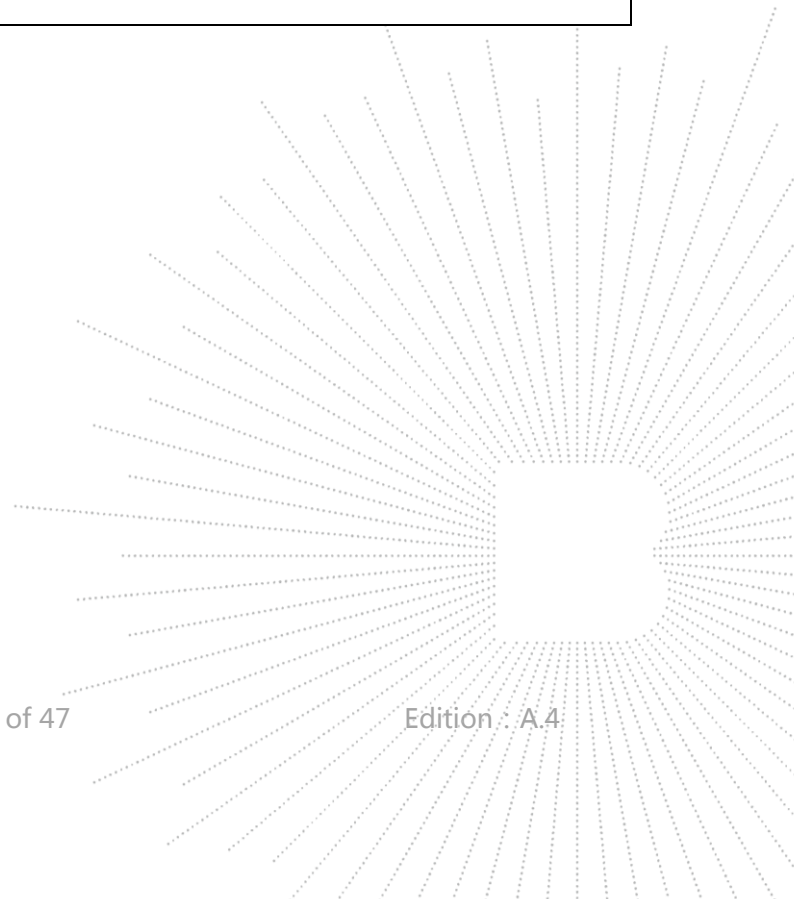

3. Measurement Uncertainty

Where relevant, the following measurement uncertainty levels have been estimated for tests performed on the Product as specified in CISPR 16-4-2. This uncertainty represents an expanded uncertainty expressed at approximately the 95% confidence level using a coverage factor of k=2.

Test item	uncertainty
RF frequency	1×10^{-7}
RF power, conducted	± 1.0 dB
Conducted spurious emission (30MHz-1GHz)	1.28 dB
Conducted spurious emission (1GHz-18GHz)	1.576 dB
Radiated Spurious emission (30MHz-1GHz)	4.30 dB
Radiated Spurious emission (1GHz-18GHz)	4.5 dB
Temperature	0.59 °C
Humidity	5.3 %

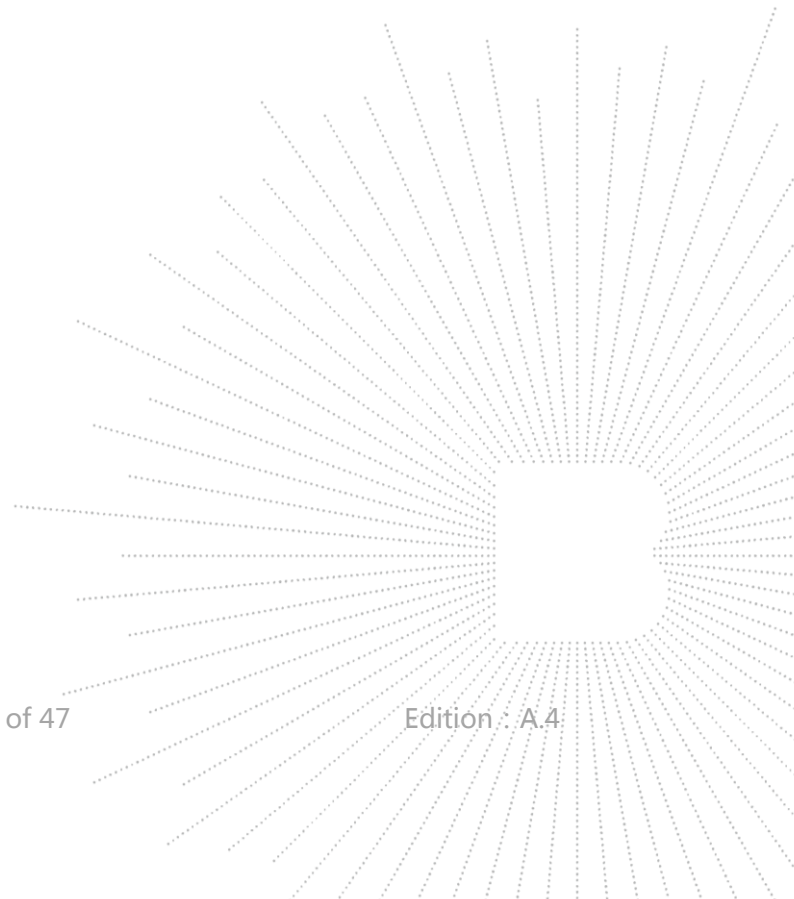

4. Product Information And Test Setup

4.1 Product Information

Model/Type Ref.:	D4E16H D4E16T, D4E32H, D4E64H, D4E128H
Model differences:	All the model are the same circuit and RF module, except model names.
Bluetooth Version:	BT 5.0
Operation Frequency:	Bluetooth(EDR): 2402-2480MHz
Max. RF output power:	Bluetooth(EDR): 5.74 dBm
Type of Modulation:	Bluetooth(EDR): GFSK, $\pi/4$ DQPSK, 8DPSK
Antenna installation:	Chip antenna
Antenna Gain:	2dBi
Ratings:	DC 5V from USB

Cable of Product

No.	Cable Type	Quantity	Provider	Length (m)	Shielded	Note
1	--	--	Applicant	---	Yes/No	With a ferrite ring in mid Detachable
2	--	--	BCTC	--	Yes/No	--

4.2 Test Setup Configuration

See test photographs attached in EUT TEST SETUP PHOTOGRAPHS for the actual connections between Product and support equipment.

4.3 Support Equipment

No.	Device Type	Brand	Model	Series No.	Note
1.	---	---	---	---	---

Notes:

- All the equipment/cables were placed in the worst-case configuration to maximize the emission during the test.
- Grounding was established in accordance with the manufacturer's requirements and conditions for the intended use.

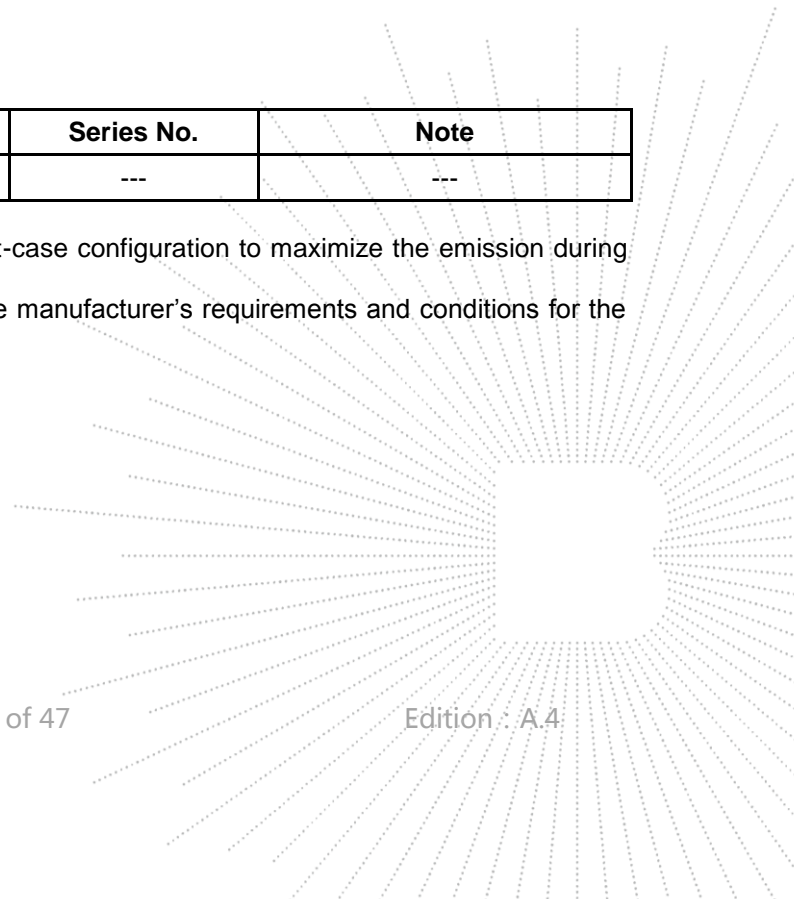

4.4 Channel List

CH No.	Frequency (MHz)	CH No.	Frequency (MHz)	CH No.	Frequency (MHz)	CH No.	Frequency (MHz)
0	2402	1	2403	2	2404	3	2405
4	2406	5	2407	6	2408	7	2409
8	2410	9	2411	10	2412	11	2413
12	2414	13	2415	14	2416	15	2417
16	2418	17	2419	18	2420	19	2421
20	2422	21	2423	22	2424	23	2425
24	2426	25	2427	26	2428	27	2429
28	2430	29	2431	30	2432	31	2433
32	2434	33	2435	34	2436	35	2437
36	2438	37	2439	38	2440	39	2441
40	2442	41	2443	42	2444	43	2445
44	2446	45	2447	46	2448	47	2449
48	2450	49	2451	50	2452	51	2453
52	2454	53	2455	54	2456	55	2457
56	2458	57	2459	58	2460	59	2461
60	2462	61	2463	62	2464	63	2465
64	2466	65	2467	66	2468	67	2469
68	2470	69	2471	70	2472	71	2473
72	2474	73	2475	74	2476	75	2477
76	2478	77	2479	78	2480		

4.5 Test Mode

All test mode(s) and condition(s) mentioned were considered and evaluated respectively by performing full tests, the worst data were recorded and reported.

Test mode	Low channel	Middle channel	High channel
Transmitting (GFSK/π/4DQPSK/8DPSK)	2402MHz	2441MHz	2480MHz
Receiving (GFSK/π/4DQPSK/8DPSK)	2402MHz	2441MHz	2480MHz

4.6 Test Environment

1. Normal Test Conditions:

Humidity(%):	54
Atmospheric Pressure(kPa):	101
Temperature(°C):	26
Test Voltage(DC):	5V

2. Extreme Test Conditions:

For tests at extreme temperatures, measurements shall be made over the extremes of the operating temperature range as declared by the manufacturer.

For tests at extreme voltages, measurements shall be made over the extremes of the power source voltage range as declared by the manufacturer.

Test Conditions	LT	HT
Temperature (°C)	0	35

5. Test Facility And Test Instrument Used

5.1 Test Facility

All measurement facilities used to collect the measurement data are located at Shenzhen BCTC Testing Co., Ltd. Address: 1-2/F., Building B, Pengzhou Industrial Park, No.158, Fuyuan 1st Road, Tangwei, Fuhai Subdistrict, Bao'an District, Shenzhen, Guangdong, China. The site and apparatus are constructed in conformance with the requirements of ANSI C63.4 and CISPR 16-1-1 other equivalent standards.

5.2 Test Instrument Used

Item	Equipment	Manufacturer	Type No.	Serial No.	Last calibration	Calibrated until
1	966 chamber	ChengYu	966 Room	966	Jun. 06. 2020	Jun. 05, 2023
2	Receiver	R&S	ESR3	102075	May 28, 2021	May 27, 2022
3	Spectrum Analyzer	Agilent	E4407B	MY45109572	May 28, 2021	May 27, 2022
4	Amplifier	SKET	LAPA_01G18 G-45dB	\	May 28, 2021	May 27, 2022
5	Amplifier	Schwarzbeck	BBV9744	9744-0037	May 28, 2021	May 27, 2022
6	TRILOG Broadband Antenna	Schwarzbeck	VULB 9163	942	Jun. 01, 2021	May 31, 2022
7	Horn Antenna	Schwarzbeck	BBHA9120D	1541	Jun. 02, 2021	Jun. 01, 2022
8	band rejection filter	ZBSF	ZBSF-C2441. 5	1706003606	May 28, 2021	May 27, 2022
9	Signal Generator	Keysight	N5181A	MY50143748	Jun. 29, 2021	Jun. 28, 2022
10	Communication test set	R&S	CMU200	119435	May 28, 2021	May 27, 2022
11	Spectrum Analyzer	Keysight	N9020A	MY49100060	May 28, 2021	May 27, 2022
12	Signal Generator	Keysight	N5182B	MY56200519	May 28, 2021	May 27, 2022
13	Power Meter	Keysight	E4419	\	May 28, 2021	May 27, 2022
14	Power Sensor	Keysight	E9300A	\	May 28, 2021	May 27, 2022
15	Horn antenna	Schwarzbeck	BBHA9170	00822	Jun. 15, 2021	Jun. 14, 2022
16	Preamplifier	MITEQ	TTA1840-35- HG	2034381	May 28, 2021	May 27, 2022
17	Software	Frad	EZ-EMC	FA-03A2 RE	\	\
18	Software	Keysight	Keysight.ETS LTest system	1.02.05	\	\
19	D.C. Power Supply	LongWei	TPR-6405D	\	\	\
20	Loop Antenna	Schwarzbeck	FMZB1519B	00014	Jun. 02, 2021	Jun. 01, 2022
21	Communication test set	Agilent	N4010A	MY49081107	May 28, 2021	May 27, 2022
22	Programmable constant temperature and humidity test chamber	DGBELL	BTKS5-150C	\	Jul. 06, 2021	Jul. 05, 2022

6. Information As Required

ETSI EN 300 328 V2.2.2 Annex E

a) The type of modulation used by the equipment:
<input checked="" type="checkbox"/> FHSS
<input type="checkbox"/> non-FHSS
b) In case of FHSS :
<input type="checkbox"/> In case of non-Adaptive FHSS equipment: The number of Hopping Frequencies: _
<input checked="" type="checkbox"/> In case of Adaptive Frequency Hopping Equipment: The maximum number of Hopping Frequencies: <u>79</u> The minimum number of Hopping Frequencies: <u>79</u>
<input checked="" type="checkbox"/> The (average) Dwell Time: <u>308.160 ms maximum</u>
c) Adaptive / non-adaptive equipment:
<input type="checkbox"/> non-adaptive Equipment
<input checked="" type="checkbox"/> adaptive Equipment without the possibility to switch to a non-adaptive mode
<input type="checkbox"/> adaptive Equipment which can also operate in a non-adaptive mode
d) In case of adaptive equipment:
The maximum Channel Occupancy Time implemented by the equipment: <u>910.080 ms</u>
<input type="checkbox"/> The equipment has implemented an LBT mechanism
<input type="checkbox"/> In case of non-FHSS equipment: <input type="checkbox"/> The equipment is Frame Based equipment <input checked="" type="checkbox"/> The equipment is Load Based equipment <input type="checkbox"/> The equipment can switch dynamically between Frame Based and Load Based equipment
The CCA time implemented by the equipment: μ s
<input type="checkbox"/> The equipment has implemented a DAA mechanism
<input type="checkbox"/> The equipment can operate in more than one adaptive mode
e) In case of non-adaptive Equipment:
The maximum RF Output Power (e.i.r.p.):
The maximum (corresponding) Duty Cycle:
Equipment with dynamic behaviour, that behaviour is described here. (e.g. the different combinations of duty cycle and corresponding power levels to be declared):
f) The worst case operational mode for each of the following tests:
<input checked="" type="checkbox"/> RF Output Power: GFSK
<input type="checkbox"/> Power Spectral Density:
<input type="checkbox"/> Duty cycle, Tx-Sequence, Tx-gap:
<input checked="" type="checkbox"/> Accumulated Transmit time, Frequency Occupation & Hopping Sequence (only for FHSS equipment): 8DPSK
<input checked="" type="checkbox"/> Hopping Frequency Separation (only for FHSS equipment): GFSK
<input type="checkbox"/> Medium Utilization:
<input checked="" type="checkbox"/> Adaptivity & Receiver Blocking: GFSK
<input checked="" type="checkbox"/> Nominal Channel Bandwidth: 8DPSK
<input checked="" type="checkbox"/> Transmitter unwanted emissions in the OOB domain: GFSK
<input checked="" type="checkbox"/> Transmitter unwanted emissions in the spurious domain: GFSK
<input checked="" type="checkbox"/> Receiver spurious emissions : GFSK
g) The different transmit operating modes (tick all that apply):
<input checked="" type="checkbox"/> Operating mode 1: Single Antenna Equipment
<input checked="" type="checkbox"/> Equipment with only one antenna
<input type="checkbox"/> Equipment with two diversity antennas but only one antenna active at any moment in time
<input type="checkbox"/> Smart Antenna Systems with two or more antennas, but operating in a (legacy) mode where only One antenna is used (e.g. IEEE 802.11™ legacy mode in smart antenna systems)
<input type="checkbox"/> Operating mode 2: Smart Antenna Systems - Multiple Antennas without beam forming
<input type="checkbox"/> Single spatial stream / Standard throughput / (e.g. IEEE 802.11™ legacy mode)

<input type="checkbox"/> High Throughput (> 1 spatial stream) using Nominal Channel Bandwidth 1																
<input type="checkbox"/> High Throughput (> 1 spatial stream) using Nominal Channel Bandwidth 2																
NOTE 1: Add more lines if more channel bandwidths are supported.																
<input type="checkbox"/> Operating mode 3: Smart Antenna Systems - Multiple Antennas with beam forming																
<input type="checkbox"/> Single spatial stream / Standard throughput (e.g. IEEE 802.11™ [i.3] legacy mode)																
<input type="checkbox"/> High Throughput (> 1 spatial stream) using Nominal Channel Bandwidth 1																
<input type="checkbox"/> High Throughput (> 1 spatial stream) using Nominal Channel Bandwidth 2																
NOTE 2: Add more lines if more channel bandwidths are supported.																
h) In case of Smart Antenna Systems:																
The number of Receive chains:																
The number of Transmit chains:																
<input type="checkbox"/> symmetrical power distribution																
<input type="checkbox"/> asymmetrical power distribution																
In case of beam forming, the maximum (additional) beam forming gain:																
NOTE: The additional beam forming gain does not include the basic gain of a single antenna.																
i) Operating Frequency Range(s) of the equipment:																
Operating Frequency Range 1: Refer to section 4.1																
Operating Frequency Range 2: _																
NOTE: Add more lines if more Frequency Ranges are supported.																
j) Nominal Channel Bandwidth(s):																
Nominal Channel Bandwidth <u>1.983 MHz Max.</u>																
NOTE: Add more lines if more channel bandwidths are supported.																
k) Type of Equipment (stand-alone, combined, plug-in radio device, etc.):																
<input checked="" type="checkbox"/> Stand-alone																
<input type="checkbox"/> Combined Equipment																
<input type="checkbox"/> Plug-in radio device																
<input type="checkbox"/> Other																
l) The normal and the extreme operating conditions that apply to the equipment:																
Refer to section 4.6																
m) The intended combination(s) of the radio equipment power settings and one or more antenna assemblies and their corresponding e.i.r.p. levels:																
Antenna Type:																
<input checked="" type="checkbox"/> Chip antenna																
Antenna Gain: Refer to section 4.1																
If applicable, additional beamforming gain (excluding basic antenna gain):																
<input type="checkbox"/> Temporary RF connector provided																
<input type="checkbox"/> No temporary RF connector provided																
<input type="checkbox"/> Dedicated Antennas (equipment with antenna connector)																
<input type="checkbox"/> Single power level with corresponding antenna(s)																
<input type="checkbox"/> Multiple power settings and corresponding antenna(s)																
Number of different Power Levels:																
Power Level 1:																
Power Level 2:																
Power Level 3:																
NOTE 1: Add more lines in case the equipment has more power levels.																
NOTE 2: These power levels are conducted power levels (at antenna connector).																
For each of the Power Levels, provide the intended antenna assemblies, their corresponding gains (G) and the resulting e.i.r.p. levels also taking into account the beamforming gain (Y) if applicable																
Power Level 1:																
Number of antenna assemblies provided for this power level:																
<table border="1" style="width: 100%; border-collapse: collapse; margin-top: 20px;"> <thead> <tr> <th style="width: 25%;">Assembly #</th> <th style="width: 25%;">Gain (dBi)</th> <th style="width: 25%;">e.i.r.p.(dBm)</th> <th style="width: 25%;">Part number or model name</th> </tr> </thead> <tbody> <tr> <td>1</td> <td></td> <td></td> <td></td> </tr> <tr> <td>2</td> <td></td> <td></td> <td></td> </tr> <tr> <td>3</td> <td></td> <td></td> <td></td> </tr> </tbody> </table>	Assembly #	Gain (dBi)	e.i.r.p.(dBm)	Part number or model name	1				2				3			
Assembly #	Gain (dBi)	e.i.r.p.(dBm)	Part number or model name													
1																
2																
3																

4																							
NOTE 3: Add more rows in case more antenna assemblies are supported for this power level.																							
Power Level 2:																							
Number of antenna assemblies provided for this power level:																							
<table border="1" style="width:100%; border-collapse: collapse;"> <thead> <tr> <th style="width: 25%;">Assembly #</th> <th style="width: 25%;">Gain (dBi)</th> <th style="width: 25%;">e.i.r.p.(dBm)</th> <th style="width: 25%;">Part number or model name</th> </tr> </thead> <tbody> <tr><td style="text-align: center;">1</td><td></td><td></td><td></td></tr> <tr><td style="text-align: center;">2</td><td></td><td></td><td></td></tr> <tr><td style="text-align: center;">3</td><td></td><td></td><td></td></tr> <tr><td style="text-align: center;">4</td><td></td><td></td><td></td></tr> </tbody> </table>				Assembly #	Gain (dBi)	e.i.r.p.(dBm)	Part number or model name	1				2				3				4			
Assembly #	Gain (dBi)	e.i.r.p.(dBm)	Part number or model name																				
1																							
2																							
3																							
4																							
NOTE 4: Add more rows in case more antenna assemblies are supported for this power level.																							
Power Level 3:																							
Number of antenna assemblies provided for this power level:																							
<table border="1" style="width:100%; border-collapse: collapse;"> <thead> <tr> <th style="width: 25%;">Assembly #</th> <th style="width: 25%;">Gain (dBi)</th> <th style="width: 25%;">e.i.r.p.(dBm)</th> <th style="width: 25%;">Part number or model name</th> </tr> </thead> <tbody> <tr><td style="text-align: center;">1</td><td></td><td></td><td></td></tr> <tr><td style="text-align: center;">2</td><td></td><td></td><td></td></tr> <tr><td style="text-align: center;">3</td><td></td><td></td><td></td></tr> <tr><td style="text-align: center;">4</td><td></td><td></td><td></td></tr> </tbody> </table>				Assembly #	Gain (dBi)	e.i.r.p.(dBm)	Part number or model name	1				2				3				4			
Assembly #	Gain (dBi)	e.i.r.p.(dBm)	Part number or model name																				
1																							
2																							
3																							
4																							
NOTE 5: Add more rows in case more antenna assemblies are supported for this power level.																							
n) The nominal voltages of the stand-alone radio equipment or the nominal voltages of the combined (host) equipment or test jig in case of plug-in devices:																							
Refer to section 4.																							
o) Describe the test modes available which can facilitate testing:																							
.....																							
p) The equipment type (e.g. Bluetooth®, IEEE 802.11™ [i.3], IEEE 802.15.4™ [i.4], proprietary, etc.):																							
q) If applicable, the statistical analysis referred to in clause 5.4.1 q)																							
(to be provided as separate attachment)																							
r) If applicable, the statistical analysis referred to in clause 5.4.1 r)																							
(to be provided as separate attachment)																							
s) Geo-location capability supported by the equipment:																							
<input type="checkbox"/> Yes																							
<input type="checkbox"/> The geographical location determined by the equipment as defined in clause 4.3.1.13.2 or clause 4.3.2.12.2 is not accessible to the user																							
<input checked="" type="checkbox"/> No																							

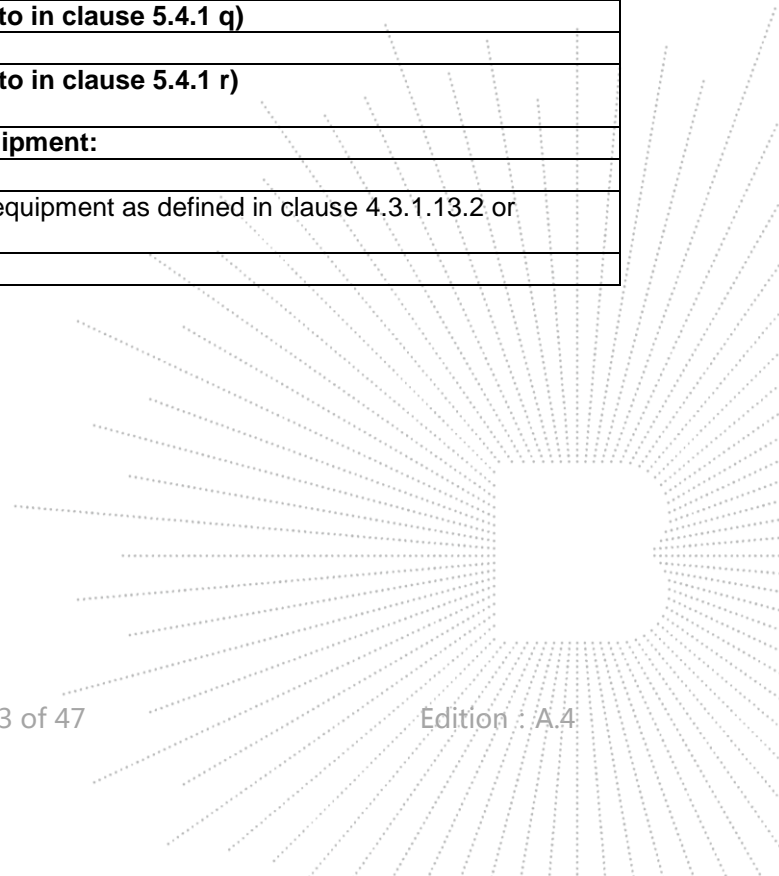

7. RF Output Power

7.1 Block Diagram Of Test Setup

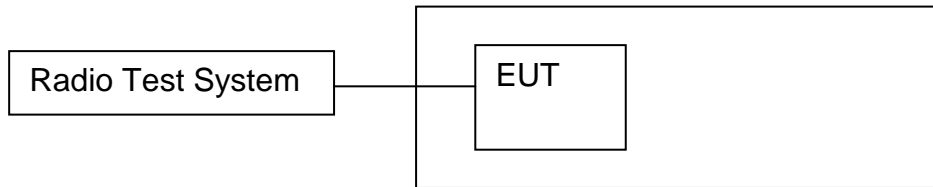

7.2 Limit

The RF output power for FHSS equipment shall be equal to or less than 20 dBm.

NOTE: For Non-adaptive FHSS equipment, the manufacturer may have declared a reduced RF Output Power (see clause 5.4.1 m) and associated Duty Cycle (see clause 5.4.1 e)) that will ensure that the equipment meets the requirement for the Medium Utilization (MU) factor further described in clause 4.3.1.6. This is verified by the conformance test referred to in clause 4.3.1.6.4.

For non-adaptive FHSS equipment, where the manufacturer has declared an RF output power lower than 20 dBm e.i.r.p., the RF output power shall be equal to or less than that declared value.

This limit shall apply for any combination of power level and intended antenna assembly.

Limit
20dBm

7.3 Test Procedure

Step 1:

- •Use a fast power sensor with a minimum sensitivity of -40 dBm and capable of minimum 1 MS/s..
- Use the following settings:
 - Sample speed 1 MS/s or faster.
 - The samples shall represent the RMS power of the signal.
 - Measurement duration: For non-adaptive equipment: equal to the observation period defined in clause 4.3.1.3.2 or clause 4.3.2.4.2. For adaptive equipment, the measurement duration shall be long enough to ensure a minimum number of bursts (at least 10) are captured.

NOTE 1: For adaptive equipment, to increase the measurement accuracy, a higher number of bursts may be used.

Step 2:

- For conducted measurements on devices with one transmit chain:
 - Connect the power sensor to the transmit port, sample the transmit signal and store the raw data. Use these stored samples in all following steps.
- For conducted measurements on devices with multiple transmit chains:
 - Connect one power sensor to each transmit port for a synchronous measurement on all transmit ports.
 - Trigger the power sensors so that they start sampling at the same time. Make sure the time difference between the samples of all sensors is less than 500 ns.
 - For each individual sampling point (time domain), sum the coincident power samples of all ports and store them. Use these summed samples as the new stored data set..

Step 3:

- Find the start and stop times of each burst in the stored measurement samples. The start and stop times are defined as the points where the power is at least 30 dB below the highest value of the stored samples in step 2. In case of insufficient sensitivity of the power sensor (e.g. in case of radiated measurements), the value of 30 dB may need to be reduced appropriately.

Step 4:

- Between the start and stop times of each individual burst calculate the RMS power over the burst using the formula below. The start and stop points shall be included. Save these Pburst values, as well as the start and stop times for each burst.

$$P_{burst} = \frac{1}{k} \sum_{n=1}^k P_{sample}(n)$$

Step 5: with 'k' being the total number of samples and 'n' the actual sample number

- The highest of all Pburst values (value "A" in dBm) will be used for maximum e.i.r.p. calculations.

Step 6:

- Add the (stated) antenna assembly gain "G" in dBi of the individual antenna.
 - In case of smart antenna systems operating in mode with beamforming (see clause 5.3.2.2.4), add the additional beamforming gain Y in dB.
 - If more than one antenna assembly is intended for this power setting, the maximum overall antenna gain (G or G + Y) shall be used.
- The RF Output Power (Pout) shall be calculated using the formula below::

$$P_{out} = A + G + Y$$

- This value, which shall comply with the limit given in clause 4.3.1.2.3 or clause 4.3.2.2.3, shall be recorded in the test report.

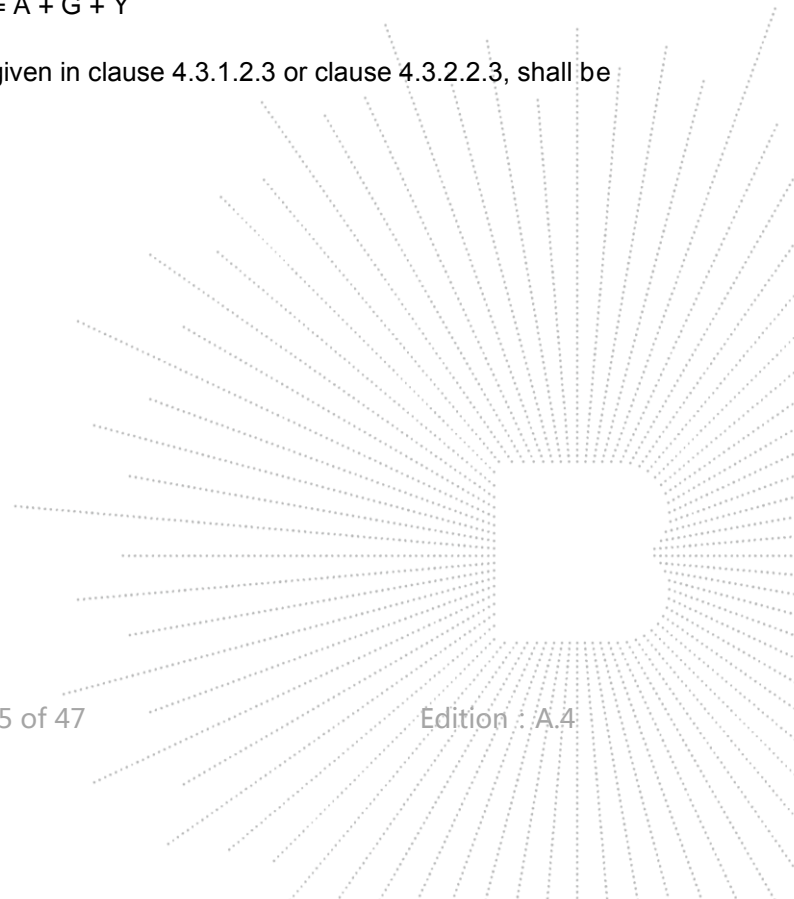

7.4 Test Result

Modulation	Test conditions (Temperature)	EIRP (dBm)
		Hopping mode
GFSK	Normal	5.74
	Lower	5.12
	Upper	4.69
$\pi/4$ DQPSK	Normal	0.83
	Lower	0.23
	Upper	-0.75
8DPSK	Normal	0.94
	Lower	0.54
	Upper	0.12
Limit		$\leq 100\text{mW}$ (20dBm)
Remark: $P = A + G + Y, G=2\text{dBi}, x=100\%$		

Test Plots

Modulation	Voltage	Conducted Power (dBm)	EIRP (dBm)
GFSK	Normal	3.74	5.74

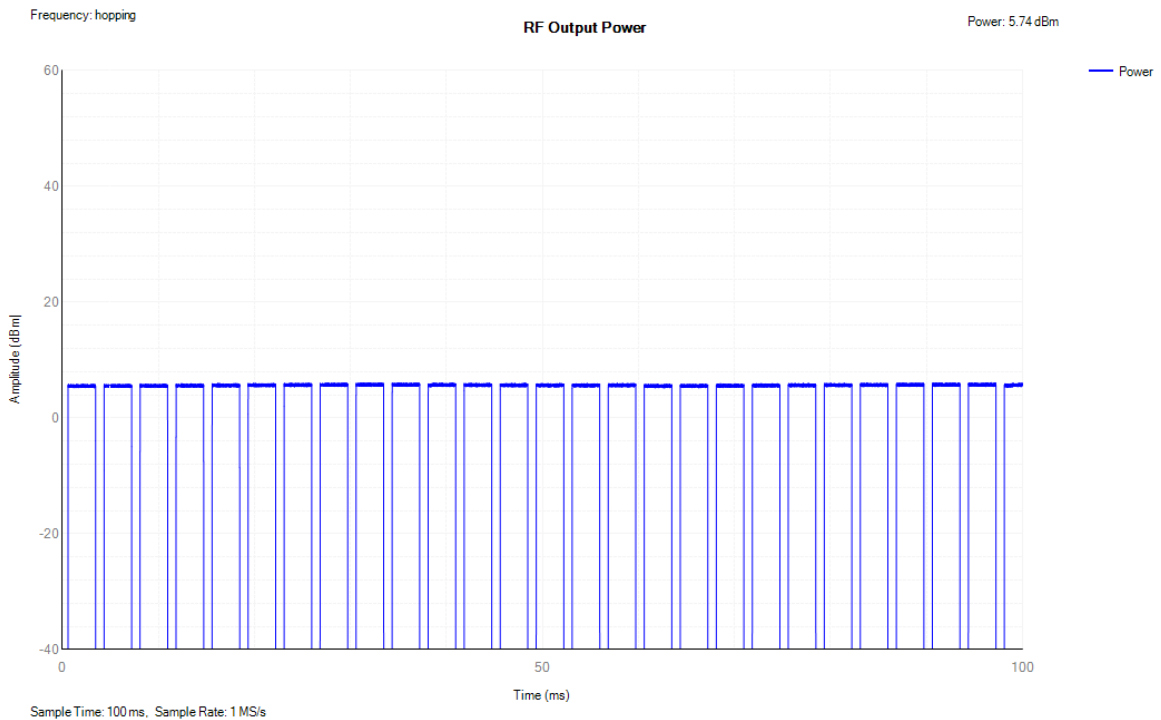

Modulation	Voltage	Conducted Power (dBm)	EIRP (dBm)
$\pi/4$ DQPSK	Normal	-1.17	0.83

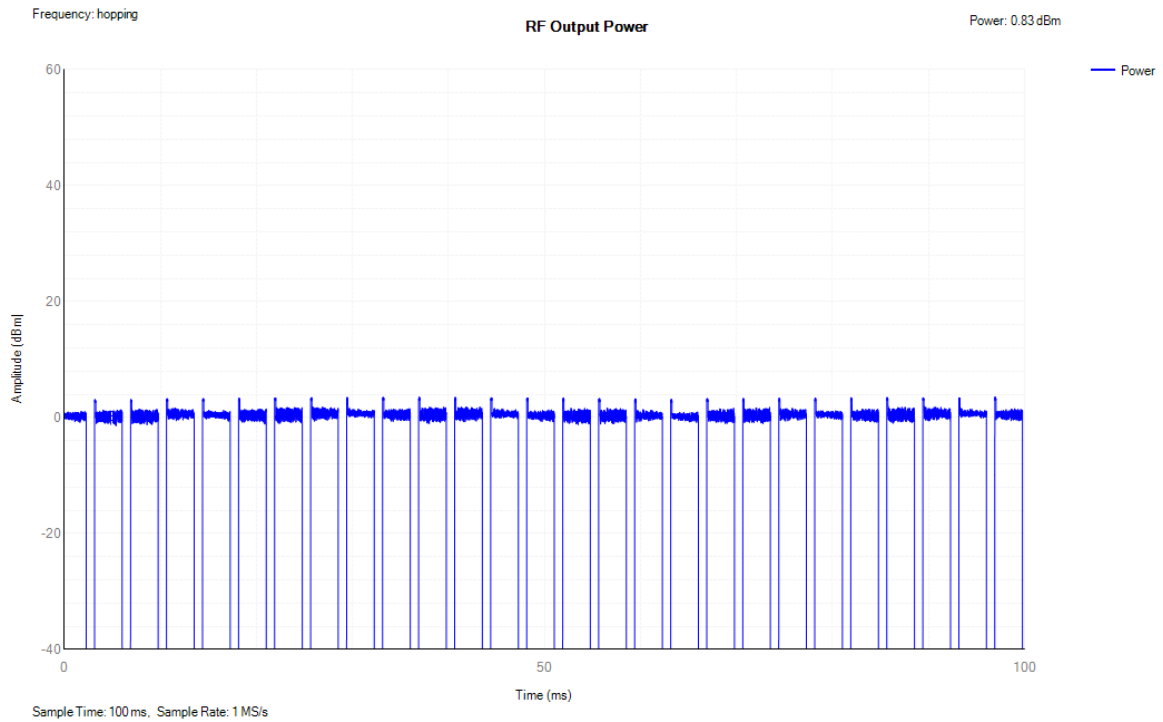

Modulation	Voltage	Conducted Power (dBm)	EIRP (dBm)
8DPSK	Normal	-1.06	0.94

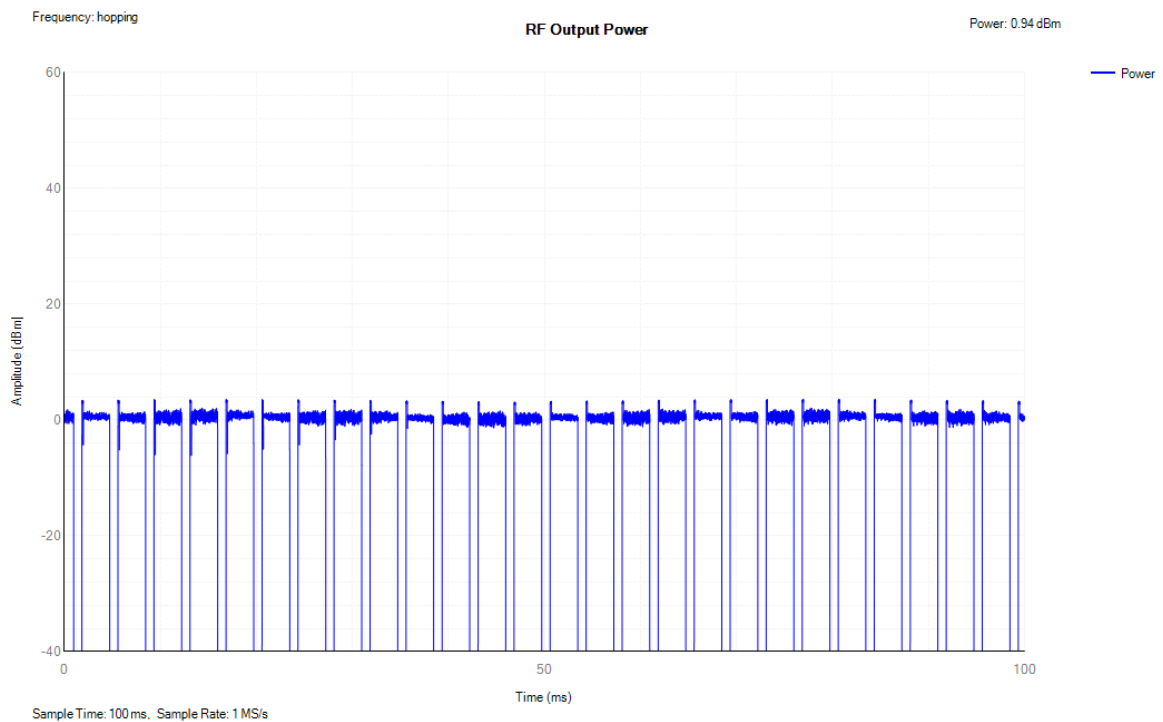

8. Accumulated Transmit Time, Minimum Frequency Occupation And Hopping Sequence

8.1 Block Diagram Of Test Setup

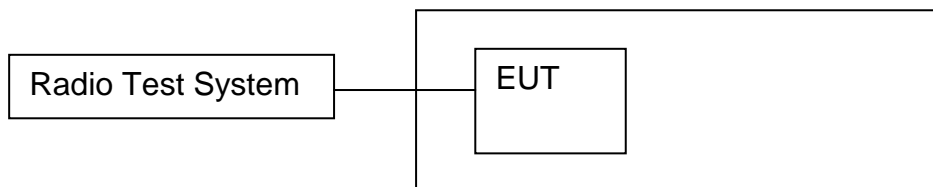

8.2 Limit

Adaptive FHSS equipment shall be capable of operating over a minimum of 70 % of the band specified in table 1.

The Accumulated Transmit Time on any hopping frequency shall not be greater than 400 ms within any observation period of 400 ms multiplied by the minimum number of hopping frequencies (N) that have to be used.

In order for the FHSS equipment to comply with the Frequency Occupation requirement, it shall meet either of the following two options:

Option 1: Each hopping frequency of the Hopping Sequence shall be occupied at least once within a period not exceeding four times the product of the dwell time and the number of hopping frequencies in use.

Option 2: The occupation probability for each frequency shall be between $((1 / U) \times 25 \%)$ and 77 % where U is the number of hopping frequencies in use.

The Hopping Sequence(s) shall contain at least N hopping frequencies at all times, where N is either 15 or the result of 15 MHz divided by the minimum Hopping Frequency Separation in MHz, whichever is the greater.

NOTE: See also clause 4.3.1.5.3.2 for the Hopping Frequency Separation applicable to adaptive FHSS equipment.

For Adaptive FHSS equipment, from the N hopping frequencies defined above, the equipment shall consider at least one hopping frequency for its transmissions. Providing that there is no interference present on this hopping frequency with a level above the detection threshold defined in clause 4.3.1.7.2.2, point 5 or clause 4.3.1.7.3.2, point 5, then the equipment shall have transmissions on this hopping frequency. For Adaptive FHSS equipment using LBT, if a signal is detected during the CCA, the equipment may jump immediately to the next hopping frequency in the Hopping Sequence (see clause 4.3.1.7.2.2, point 2) provided the limit for Accumulated Transmit Time on the new hopping frequency is respected.

hopping sequence shall be occupied at least once within a period not exceeding four times the product of the dwell time and the number of hopping frequencies in use.

Option 2: The occupation probability for each frequency shall be between $((1 / U) \times 25 \%)$ and 77 % where U is the number of hopping frequencies in use.

The hopping sequence(s) shall contain at least N hopping frequencies at all times, where N is 15 or 15 divided by the minimum Hopping Frequency Separation in MHz, whichever is the greater.

8.3 Test Procedure

Step 1:

- The output of the transmitter shall be connected to a spectrum analyzer or equivalent.
- The analyzer shall be set as follows:
 - Centre Frequency: Equal to the hopping frequency being investigated
 - Frequency Span: 0 Hz
 - RBW: ~ 50 % of the Occupied Channel Bandwidth
 - VBW: \geq RBW
 - Detector Mode: RMS
 - Sweep time: Equal to the applicable observation period (see clause 4.3.1.4.3.1 or clause 4.3.1.4.3.2)
 - Number of sweep points: 30 000
 - Trace mode: Clear / Write
 - Trigger: Free Run

Step 2:

- Save the trace data to a file for further analysis by a computing device using an appropriate software application or program.

Step 3:

- Identify the data points related to the frequency being investigated by applying a threshold. The data points resulting from transmissions on the hopping frequency being investigated are assumed to have much higher levels compared to data points resulting from transmissions on adjacent hopping frequencies. If a clear determination between these transmissions is not possible, the RBW in step 1 shall be further reduced. In addition, a channel filter may be used.
- Count the number of data points identified as resulting from transmissions on the frequency being investigated and multiply this number by the time difference between two consecutive data points.

Step 4:

- The result in step 3 is the Accumulated Transmit Time which shall comply with the limit provided in clause 4.3.1.4.3.1 or clause 4.3.1.4.3.2 and which shall be recorded in the test report.

Step 5:

This step is only applicable for equipment implementing Option 1 in clause 4.3.1.4.3.1 or Option 1 in clause 4.3.1.4.3.2 for complying with the Frequency Occupation requirement.

- Make the following changes on the analyzer and repeat step 2 and step 3.

Sweep time: $4 \times \text{Dwell Time} \times \text{Actual number of hopping frequencies in use}$

The hopping frequencies occupied by the equipment without having transmissions during the dwell time (blacklisted frequencies) should be taken into account in the actual number of hopping frequencies in use. If this number cannot be determined (number of blacklisted frequencies unknown) it shall be assumed that the equipment uses the maximum possible number of hopping frequencies.

- The result shall be compared to the limit for the Frequency Occupation defined in clause 4.3.1.4.3.1 or clause 4.3.1.4.3.2. The result of this comparison shall be recorded in the test report.

Step 6:

- Make the following changes on the analyzer:

- Start Frequency: 2 400 MHz
- Stop Frequency: 2 483,5 MHz
- RBW: ~ 50 % of the Occupied Channel Bandwidth (single hopping frequency)
- VBW: \geq RBW
- Detector Mode: Peak

- Sweep time: 1 s, this setting may result in long measuring times. To avoid such long measuring times, an FFT analyzer may be used

- Number of sweep points: $\sim 400 / \text{Occupied Channel Bandwidth (MHz)}$; the number of sweep points may need to be further increased in case of overlapping channels

- Trace Mode: Max Hold

- Trigger: Free Run

• Wait for the trace to stabilize. Identify the number of hopping frequencies used by the hopping sequence.

- The result shall be compared to the limit (value N) defined in clause 4.3.1.4.3.1 or clause 4.3.1.4.3.2. This value shall be recorded in the test report.

For equipment with blacklisted frequencies, it might not be possible to verify the number of hopping frequencies in use. However they shall comply with the requirement for Accumulated Transmit Time and Frequency Occupation assuming the minimum number of hopping frequencies (N) defined in clause 4.3.1.4.3.1 or clause 4.3.1.4.3.2 is used.

Step 7:

- For adaptive FHSS equipment, it shall be verified whether the equipment uses 70 % of the band specified in table 1. This verification can be done using the lowest and highest -20 dB points from the total spectrum envelope obtained in step 6. The result shall be recorded in the test report..

8.4 Test Result

Dwell Time One Burst

Mode	Frequency (MHz)	Pulse Time (ms)	Result
1-DH5	2441	2.867	PASS
2-DH5	2441	2.880	
3-DH5	2441	2.880	

Accumulated Transmit Time

Mode	Frequency (MHz)	Accumulated Transmit Time (ms)	Limit(ms)	Result
1-DH5	2441	303.902	400	PASS
2-DH5	2441	308.160	400	
3-DH5	2441	305.280	400	

Frequency Occupation

Mode	Frequency (MHz)	Sweep Time (ms)	Limit	Result
1-DH5	2441	905.972	1	PASS
2-DH5	2441	910.080	1	
3-DH5	2441	910.080	1	

Hopping Sequence

Mode	Hopping Number	Limit	Band Allocation (%)	Limit(%)	Result
1-DH5	79	15	95.4	70	PASS
2-DH5	79	15	95.8	70	
3-DH5	79	15	95.8	70	

9. Hopping Frequency Separation

9.1 Block Diagram Of Test Setup

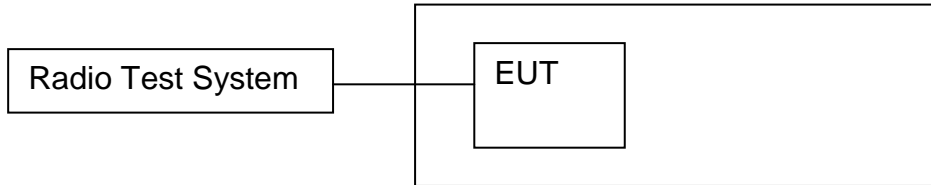

9.2 Limit

For Non-adaptive frequency hopping systems

The minimum Hopping Frequency Separation shall be equal to Occupied Channel Bandwidth (see clause 5.3.1.5.3) of a single hop, with a minimum separation of 100 kHz.

For Adaptive frequency hopping systems

The minimum Hopping Frequency Separation shall be 100 kHz.

9.3 Test Procedure

The Hopping Frequency Separation as defined in clause 4.3.1.5 shall be measured and recorded using any of the following options. The selected option shall be stated in the test report.

Option 1

Step 1:

- The output of the transmitter shall be connected to a spectrum analyzer or equivalent.
- The analyzer shall be set as follows:
 - Centre Frequency: Centre of the two adjacent hopping frequencies
 - Frequency Span: Sufficient to see the complete power envelope of both hopping frequencies
 - RBW: 1 % of the span
 - VBW: 3 × RBW
 - Detector Mode: Max Peak
 - Trace Mode: Max Hold
 - Sweep time: Auto

Step 2:

- Wait for the trace to stabilize.
- Use the marker function of the analyzer to define the frequencies corresponding to the lower -20 dBr point and the upper -20 dBr point for both hopping frequencies F1 and F2. This will result in F_{1L} and F_{1H} for hopping frequency F1 and in F_{2L} and F_{2H} for hopping frequency F2. These values shall be recorded in the report.

Step 3:

- Calculate the centre frequencies F_{1c} and F_{2c} for both hopping frequencies using the formulas below. These values shall be recorded in the report.

$$F_{1c} = \frac{F_{1L} + F_{1H}}{2} \quad F_{2c} = \frac{F_{2L} + F_{2H}}{2}$$

- Calculate the Hopping Frequency Separation (FHS) using the formula below. This value shall be recorded in the report.

$$F_{HS} = F_{2C} - F_{1C}$$

- Compare the measured Hopping Frequency Separation with the limit defined in clause 4.3.1.5.3.

- See figure 4:

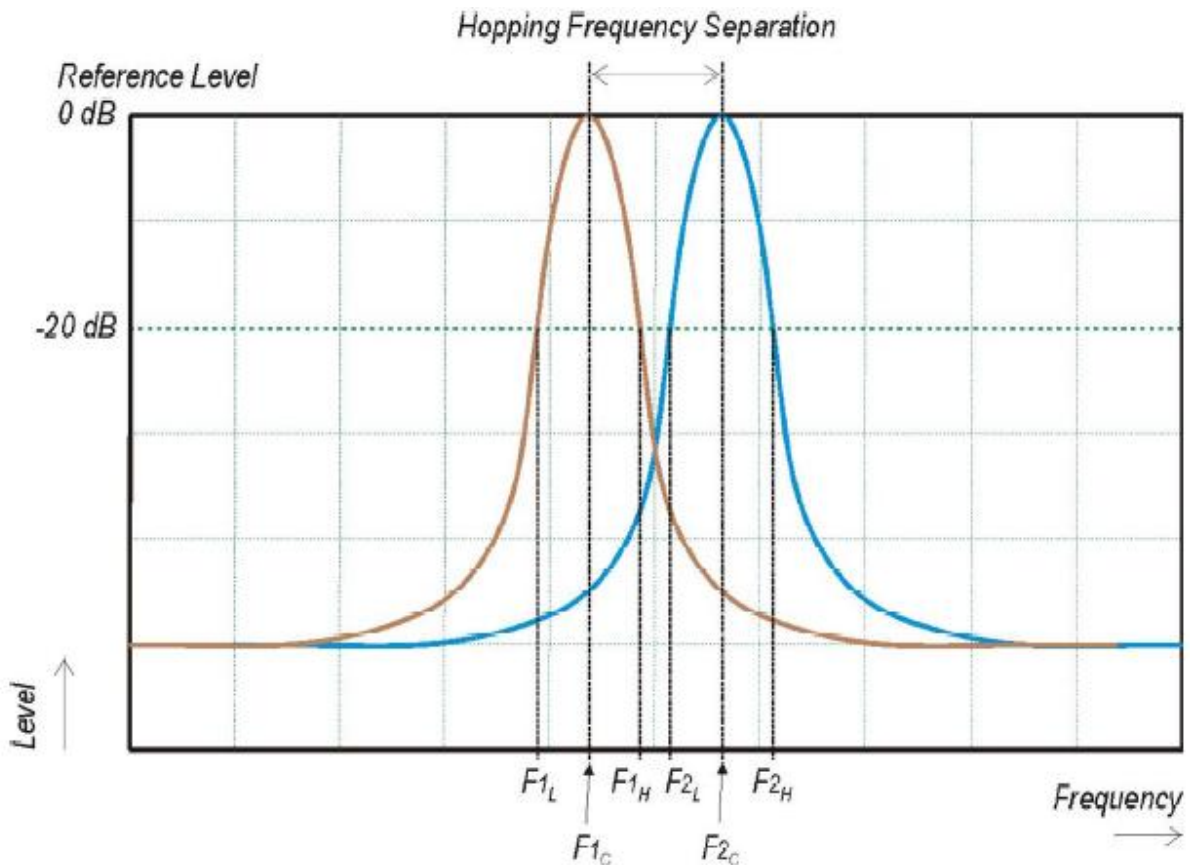

Figure 4: Hopping Frequency Separation

For adaptive equipment, in case of overlapping channels which prevents the definition of the -20 dB reference points F1H and F2L, a higher reference level (e.g. -10 dB or -6 dB) may be chosen to define the reference points F1L; F1H; F2L and F2H.

Alternatively, special test software may be used to:

- force the UUT to hop or transmit on a single Hopping Frequency by which the -20 dB reference points can be measured separately for the two adjacent Hopping Frequencies; and/or
- force the UUT to operate without modulation by which the centre frequencies F1C and F2C can be measured directly.

The method used to measure the Hopping Frequency Separation shall be documented in the test report.

9.4 Test Result

Mode		Measurement (MHz)	Limit (MHz)	Result
GFSK	DH1	1.008	0.1	PASS
	DH3	0.991	0.1	
	DH5	1.007	0.1	

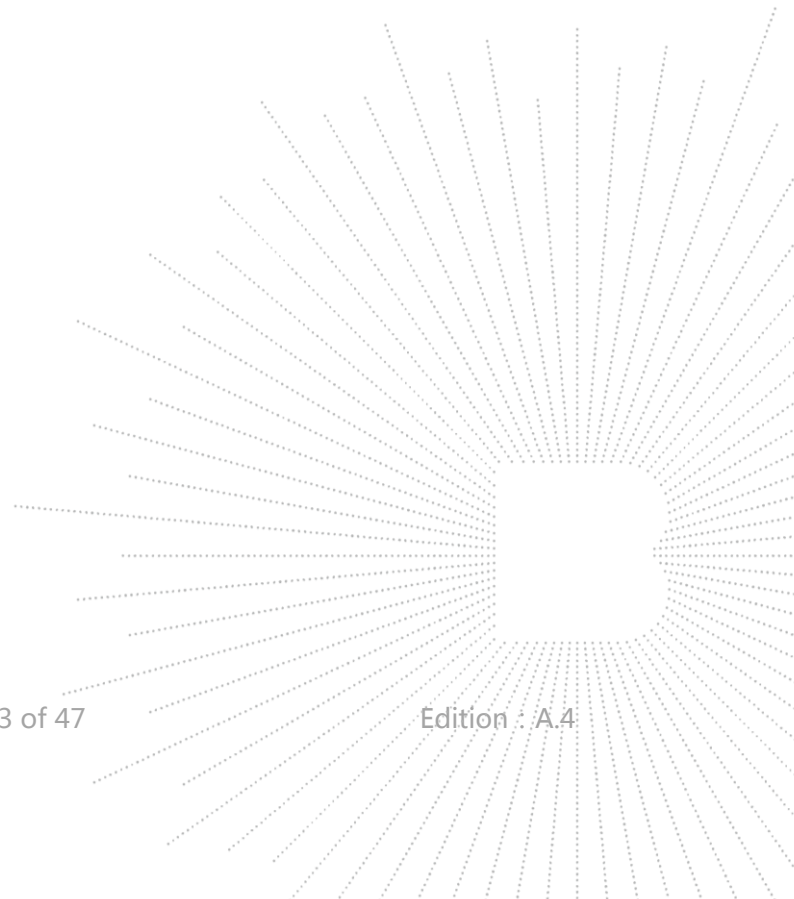

10. Occupied Channel Bandwidth

10.1 Block Diagram Of Test Setup

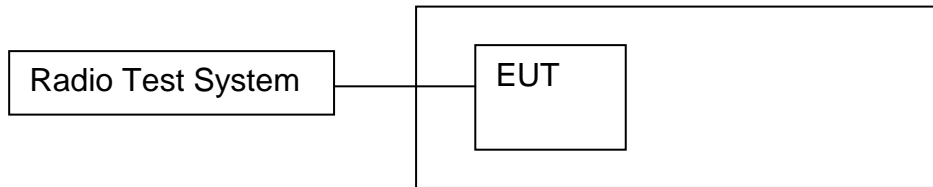

10.2 Limit

The Occupied Channel Bandwidth for each hopping frequency shall be within the band given in 2.4GHz to 2.4835GHz.

In addition, for non-adaptive FHSS equipment with e.i.r.p. greater than 10 dBm, the Occupied Channel Bandwidth for every occupied hopping frequency shall be equal to or less than 5 MHz.

10.3 Test Procedure

Step 1:

Connect the UUT to the spectrum analyzer and use the following settings:

- Centre Frequency: The centre frequency of the channel under test
- Resolution BW: $\sim 1\%$ of the span without going below 1%
- Video BW: $3 \times$ RBW
- Frequency Span: $2 \times$ Nominal Channel Bandwidth
- Detector Mode: RMS
- Trace Mode: Max Hold
- Sweep time: 1 s

Step 2:

Wait for the trace to stabilize.

Find the peak value of the trace and place the analyzer marker on this peak.

Step 3:

Use the 99 % bandwidth function of the spectrum analyzer to measure the Occupied Channel Bandwidth of the UUT.

This value shall be recorded.

NOTE: Make sure that the power envelope is sufficiently above the noise floor of the analyzer to avoid the noise signals left and right from the power envelope being taken into account by this measurement.

10.4 Test Result

Modulation	Frequency (MHz)	Frequency Range (MHz)		Occupied Channel (MHz)
GFSK	Low	2401.681	/	0.869
	High	/	2480.553	0.869
$\pi/4$ DQPSK	Low	2401.525	/	1.177
	High	/	2480.991	1.983
8DPSK	Low	2401.009	/	1.982
	High	/	2480.991	1.982

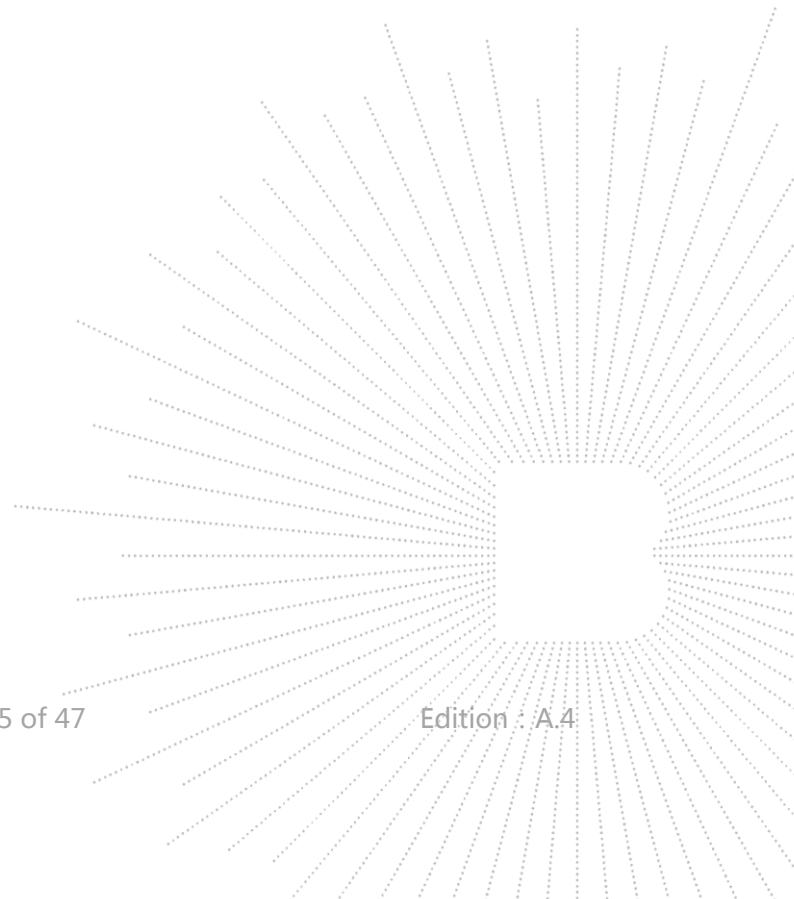

Test Plots
GFSK DH1 Low Channel

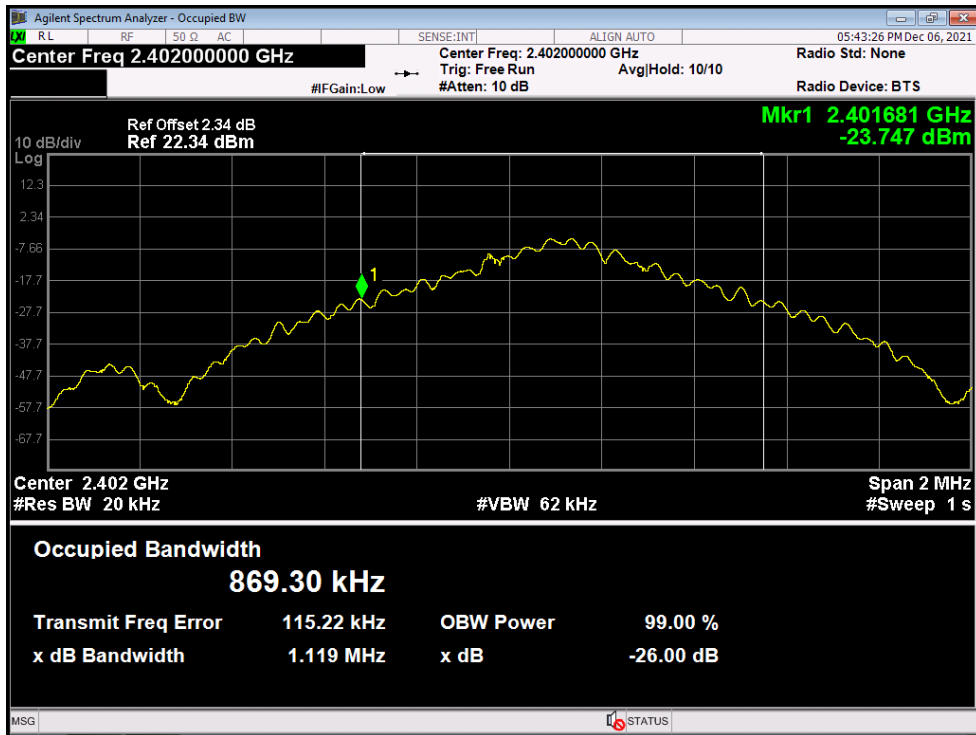

High Channel

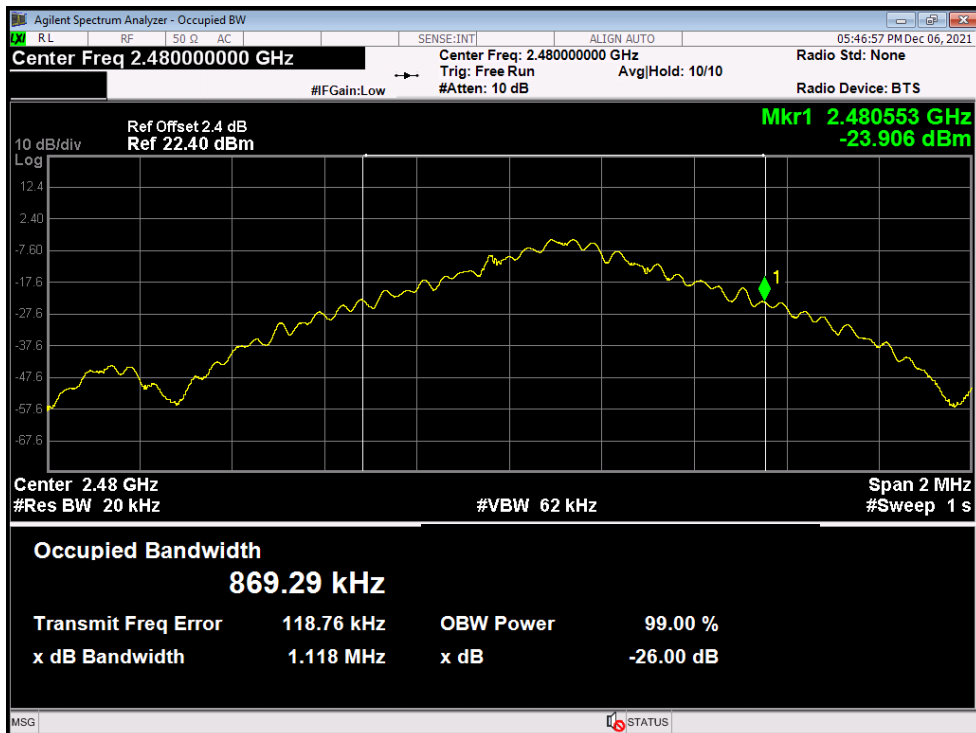

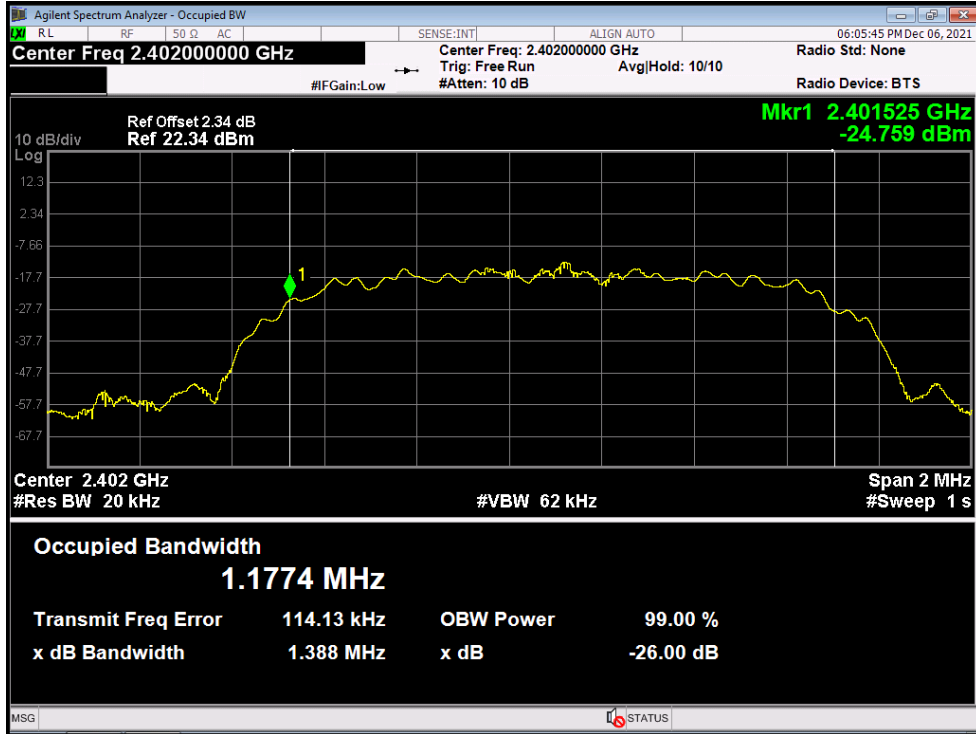
$\pi/4$ DQPSK 2DH3 Low Channel

High Channel

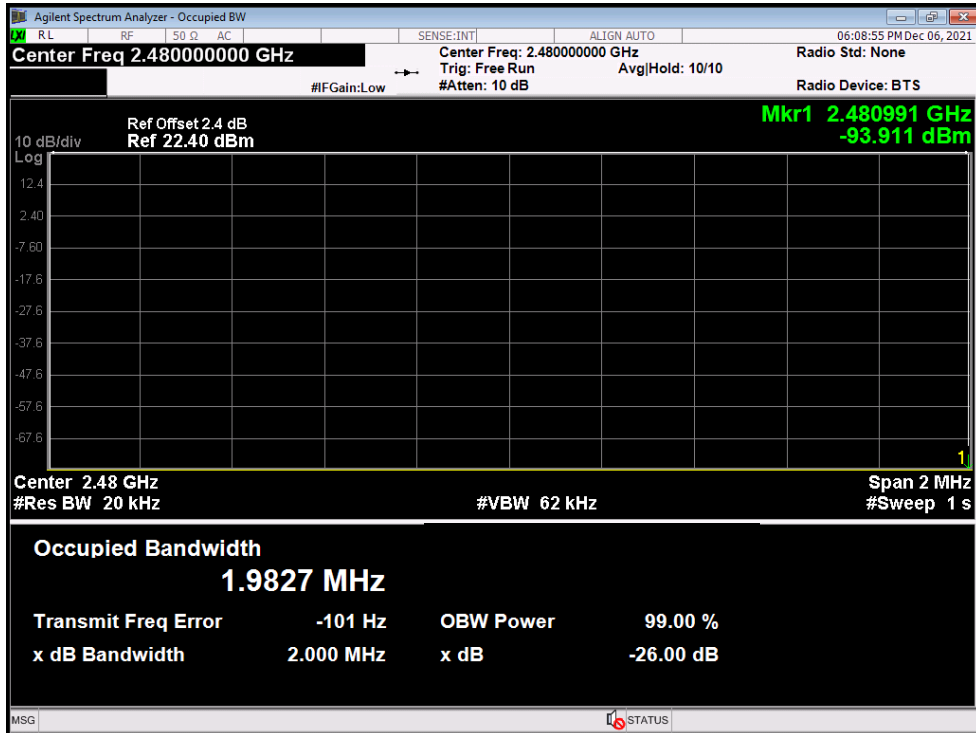

8DPSK 3DH5 Low Channel

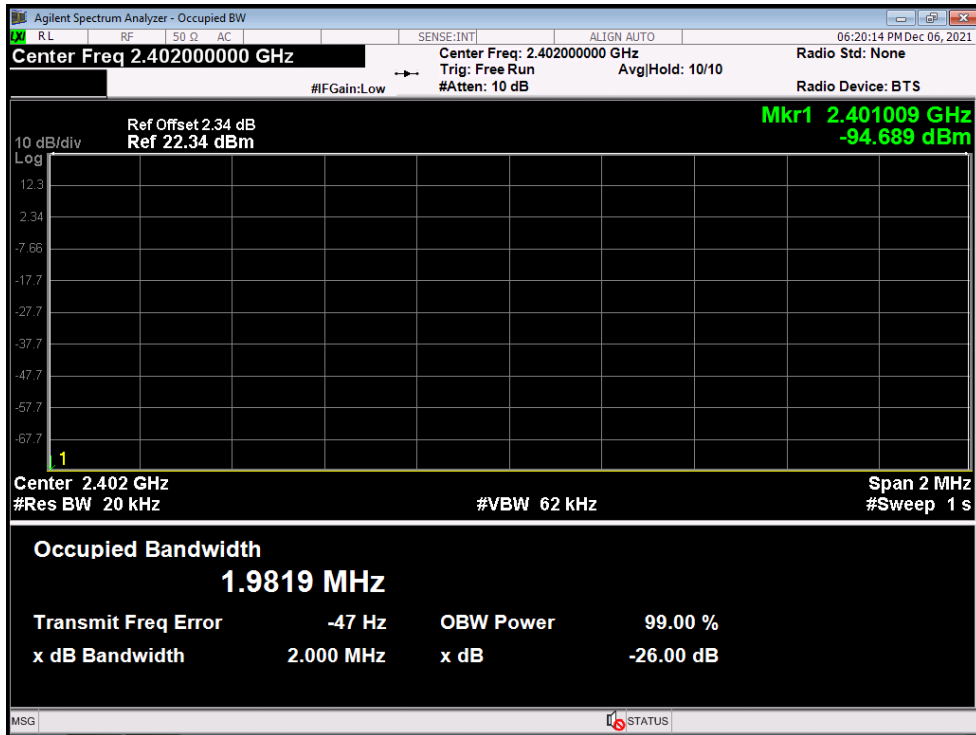

High Channel

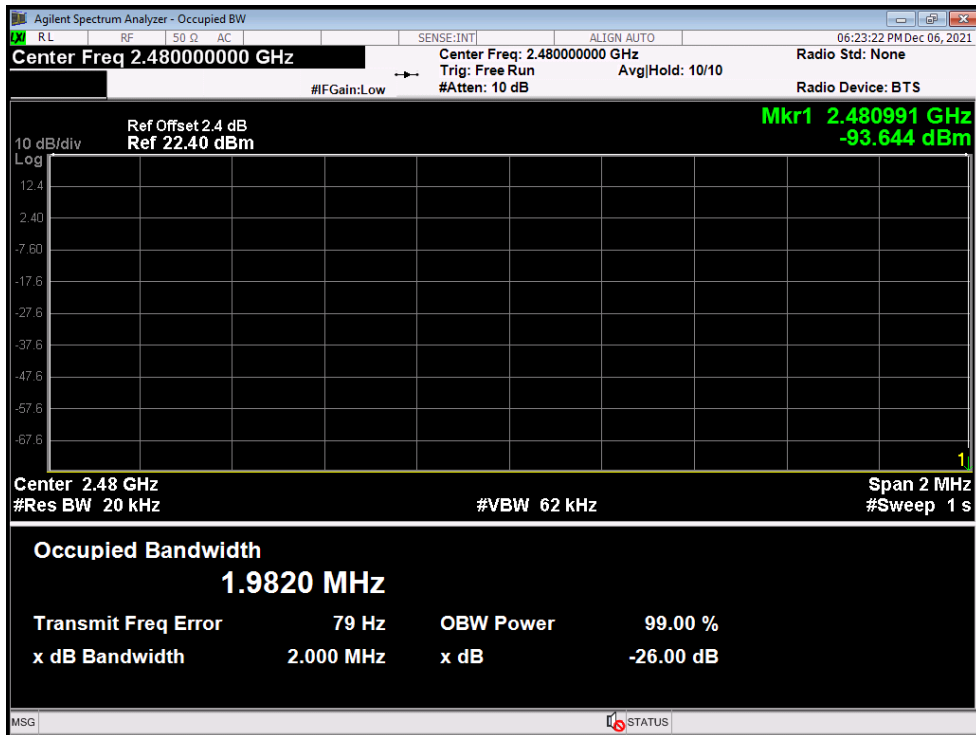

11. Transmitter Unwanted Emissions In The Out-Of-Band Domain

11.1 Block Diagram Of Test Setup

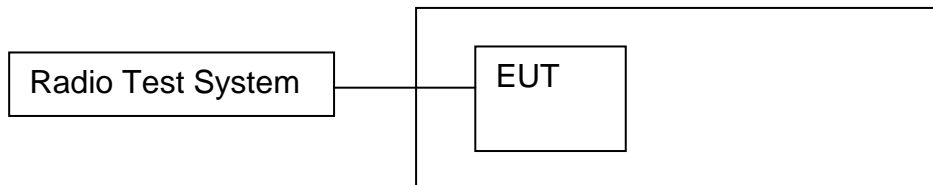

11.2 Limit

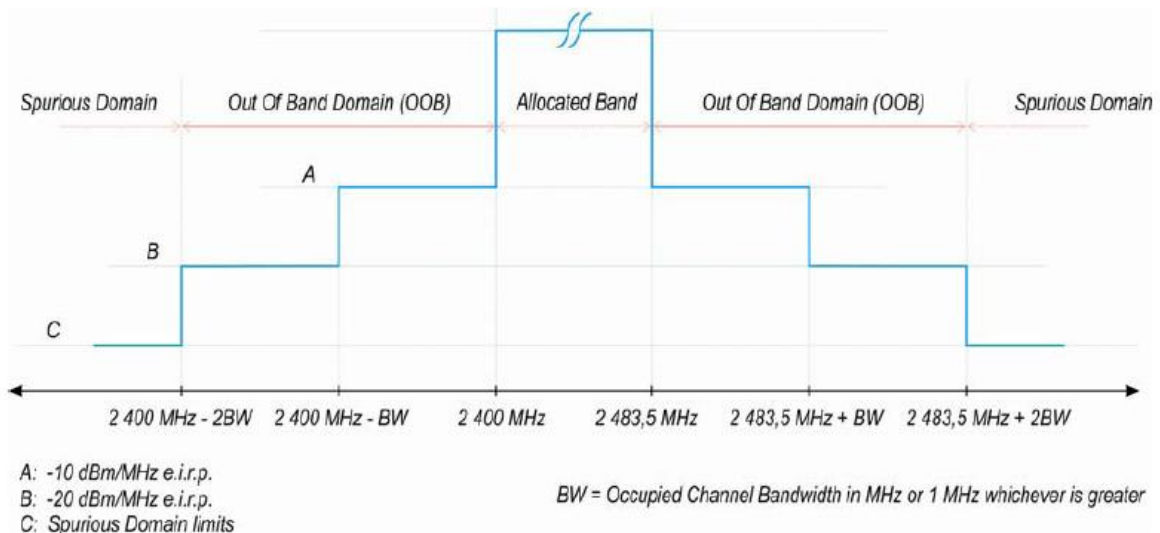

Figure 3: Transmit mask

11.3 Test Procedure

The applicable mask is defined by the measurement results from the tests performed under clause 5.4.7 (Occupied Channel Bandwidth).

The Out-of-band emissions within the different horizontal segments of the mask provided in figure 1 and figure 3 shall be measured using the procedure in step 1 to step 6 below. This method assumes the spectrum analyzer is equipped with the Time Domain Power option.

Step 1:

- Connect the UUT to the spectrum analyzer and use the following settings:
 - Measurement Mode: Time Domain Power
 - Centre Frequency: 2 484 MHz
 - Span: Zero Span
 - Resolution BW: 1 MHz
 - Filter mode: Channel filter
 - Video BW: 3 MHz

- Detector Mode: RMS
- Trace Mode: Max Hold
- Sweep Mode: Single Sweep
- Sweep Points: Sweep time [μ s] / (1 μ s) with a maximum of 30 000
- Trigger Mode: Video
- Sweep Time: >120 % of the duration of the longest burst detected during the measurement of the RF Output Power

Step 2 (segment 2 483,5 MHz to 2 483,5 MHz + BW):

- The measurement shall be performed and repeated while the trigger level is increased until no triggering takes place.
- For FHSS equipment operating in a normal hopping mode, the different hops will result in signal bursts with different power levels. In this case the burst with the highest power level shall be selected.
 - Set a window (start and stop lines) to match with the start and end of the burst and in which the RMS power shall be measured using the Time Domain Power function..
- Select RMS power to be measured within the selected window and note the result which is the RMS power within this 1 MHz segment (2 483,5 MHz to 2 484,5 MHz). Compare this value with the applicable limit provided by the mask.
- Increase the centre frequency in steps of 1 MHz and repeat this measurement for every 1 MHz segment within the range 2 483,5 MHz to 2 483,5 MHz + BW. The centre frequency of the last 1 MHz segment shall be set to 2 483,5 MHz + BW - 0,5 MHz (which means this may partly overlap with the previous 1 MHz segment).

Step 3 (segment 2 483,5 MHz + BW to 2 483,5 MHz + 2BW):

- Change the centre frequency of the analyzer to 2 484 MHz + BW and perform the measurement for the first 1 MHz segment within range 2 483,5 MHz + BW to 2 483,5 MHz + 2BW. Increase the centre frequency in 1 MHz steps and repeat the measurements to cover this whole range. The centre frequency of the last 1 MHz segment shall be set to 2 483,5 MHz + 2 BW - 0,5 MHz (which means this may partly overlap with the previous 1 MHz segment).

Step 4 (segment 2 400 MHz - BW to 2 400 MHz):

- Change the centre frequency of the analyzer to 2 399,5 MHz and perform the measurement for the first 1 MHz segment within range 2 400 MHz - BW to 2 400 MHz Reduce the centre frequency in 1 MHz steps and repeat the measurements to cover this whole range. The centre frequency of the last 1 MHz segment shall be set to 2 400 MHz - BW + 0,5 MHz (which means this may partly overlap with the previous 1 MHz segment).

Step 5 (segment 2 400 MHz - 2BW to 2 400 MHz - BW):

- Change the centre frequency of the analyzer to 2 399,5 MHz - BW and perform the measurement for the first 1 MHz segment within range 2 400 MHz - 2BW to 2 400 MHz - BW. Reduce the centre frequency in 1 MHz steps and repeat the measurements to cover this whole range. The centre frequency of the last 1 MHz segment shall be set to 2 400 MHz - 2BW + 0,5 MHz (which means this may partly overlap with the previous 1 MHz segment).

Step 6:

- In case of conducted measurements on equipment with a single transmit chain, the declared antenna assembly gain G in dBi shall be added to the results for each of the 1 MHz segments and compared with the limits provided by the mask given in figure 1 or figure 3. If more than one antenna assembly is intended for this power setting, the antenna with the highest gain shall be considered.
 - In case of conducted measurements on smart antenna systems (equipment with multiple transmit chains), the measurements need to be repeated for each of the active transmit chains. The declared antenna assembly gain "G" in dBi for a single antenna shall be added to these results. If more than one antenna assembly is intended for this power setting, the antenna with the highest gain shall be considered. Comparison with the applicable limits shall be done using any of the options given below:
 - Option 1: the results for each of the transmit chains for the corresponding 1 MHz segments shall be added. The additional beamforming gain "Y" in dB shall be added as well and the resulting values compared with the limits provided by the mask given in figure 1 or figure 3.
 - Option 2: the limits provided by the mask given in figure 1 or figure 3 shall be reduced by $10 \times \log_{10}(A_{ch})$ and the additional beamforming gain Y in dB. The results for each of the transmit chains shall be individually compared with these reduced limits.
- NOTE: A_{ch} refers to the number of active transmit chains.

It shall be recorded whether the equipment complies with the mask provided in figure 1 or figure 3

11.4 Test Result

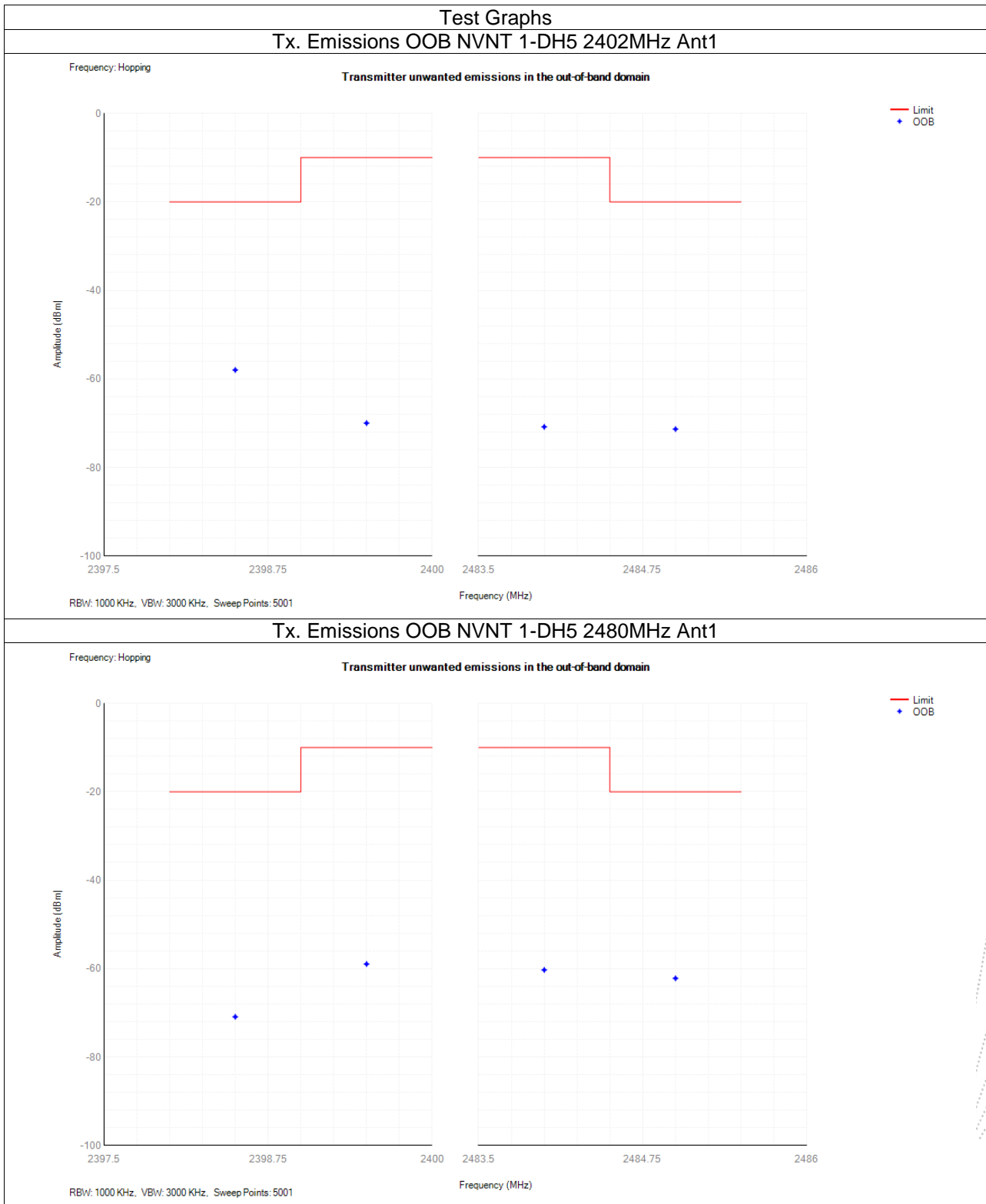

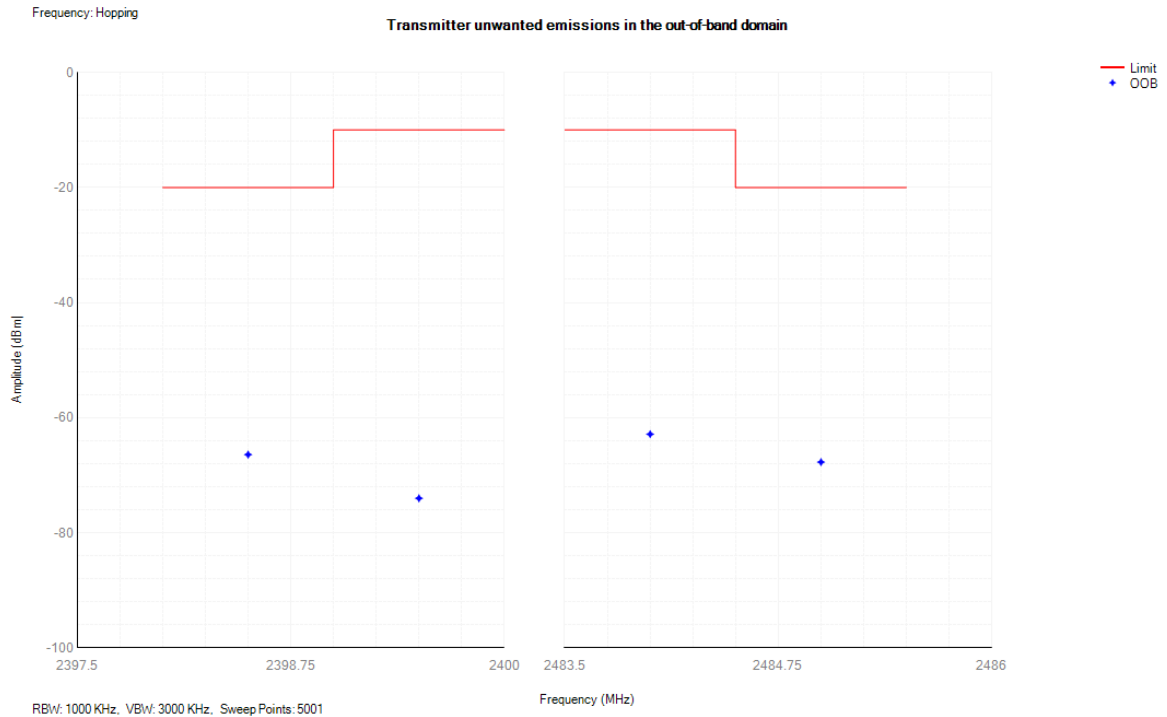
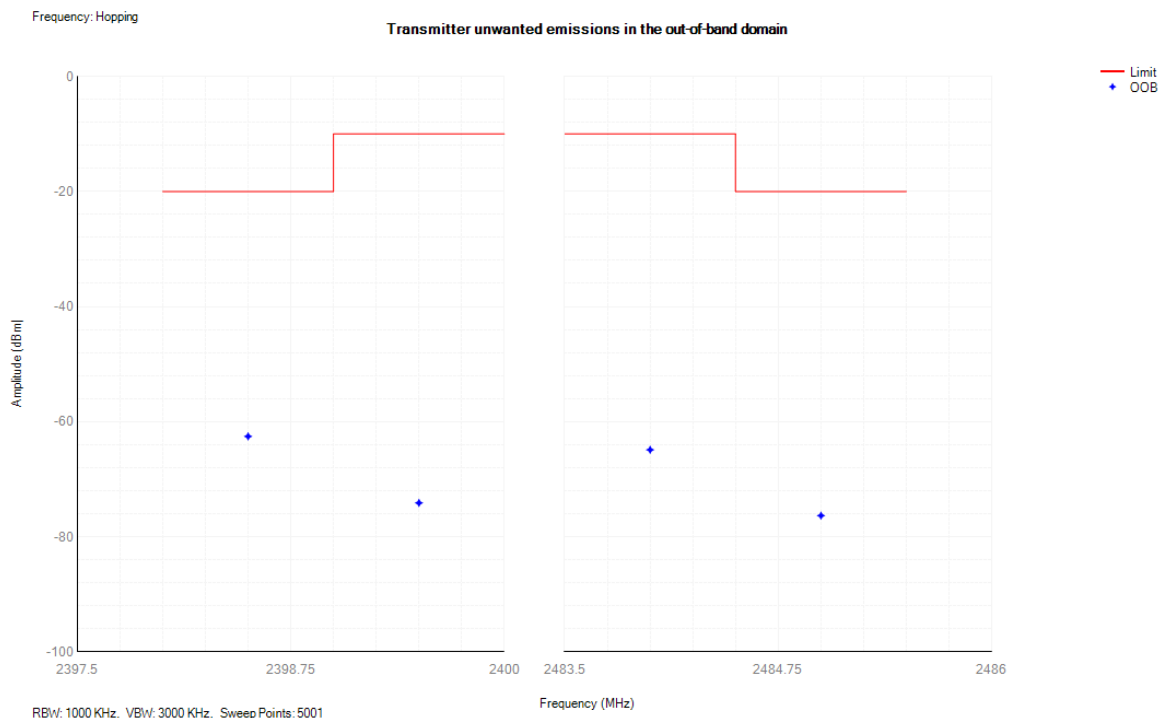
Tx. Emissions OOB NVNT 2-DH5 2402MHz Ant1

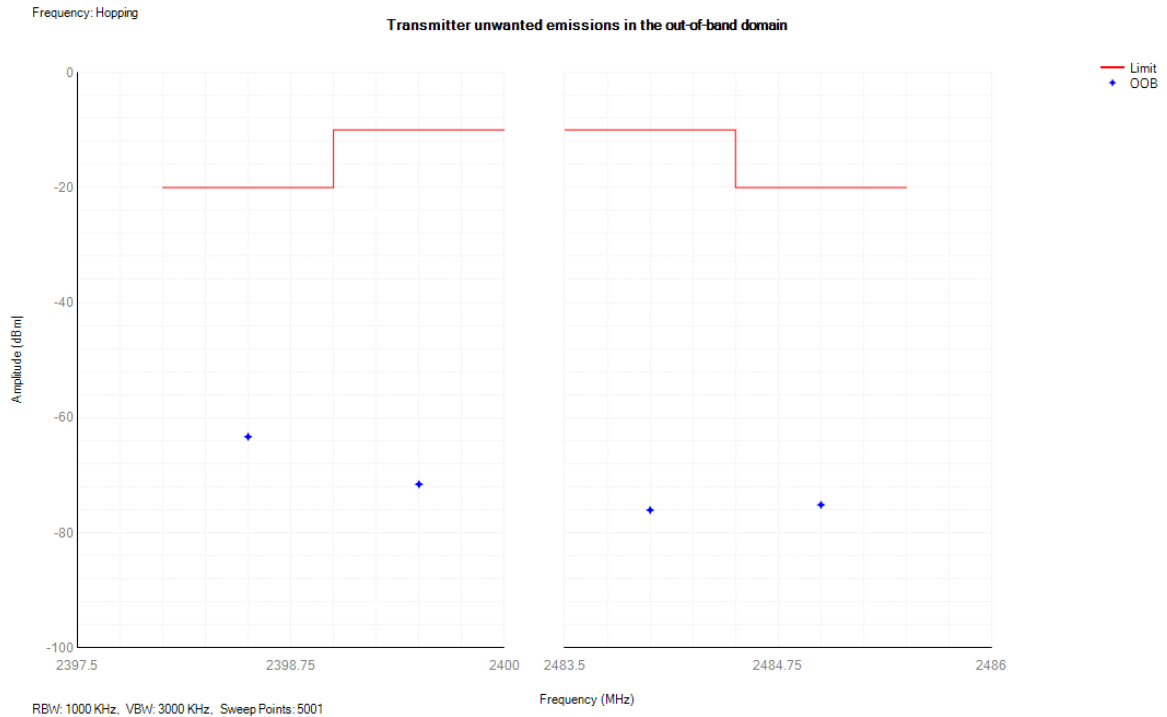
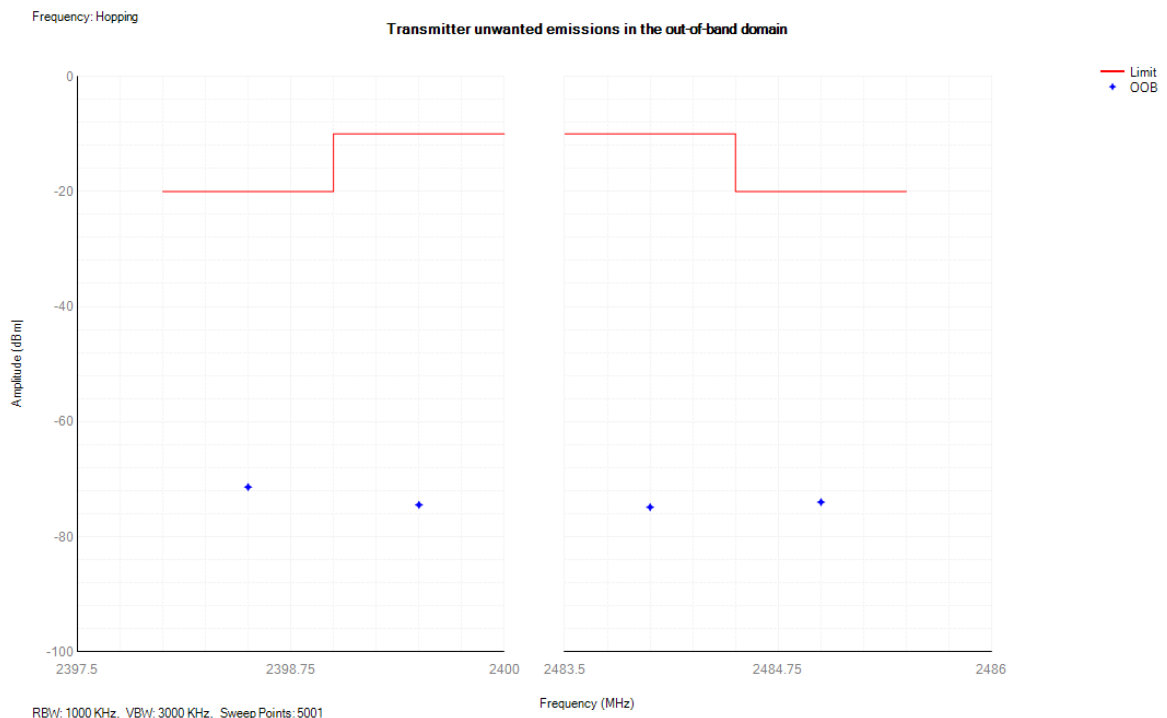
Tx. Emissions OOB NVNT 2-DH5 2480MHz Ant1

Tx. Emissions OOB NVNT 3-DH5 2402MHz Ant1

Tx. Emissions OOB NVNT 3-DH5 2480MHz Ant1

12. Transmitter Unwanted Emissions In The Spurious Domain

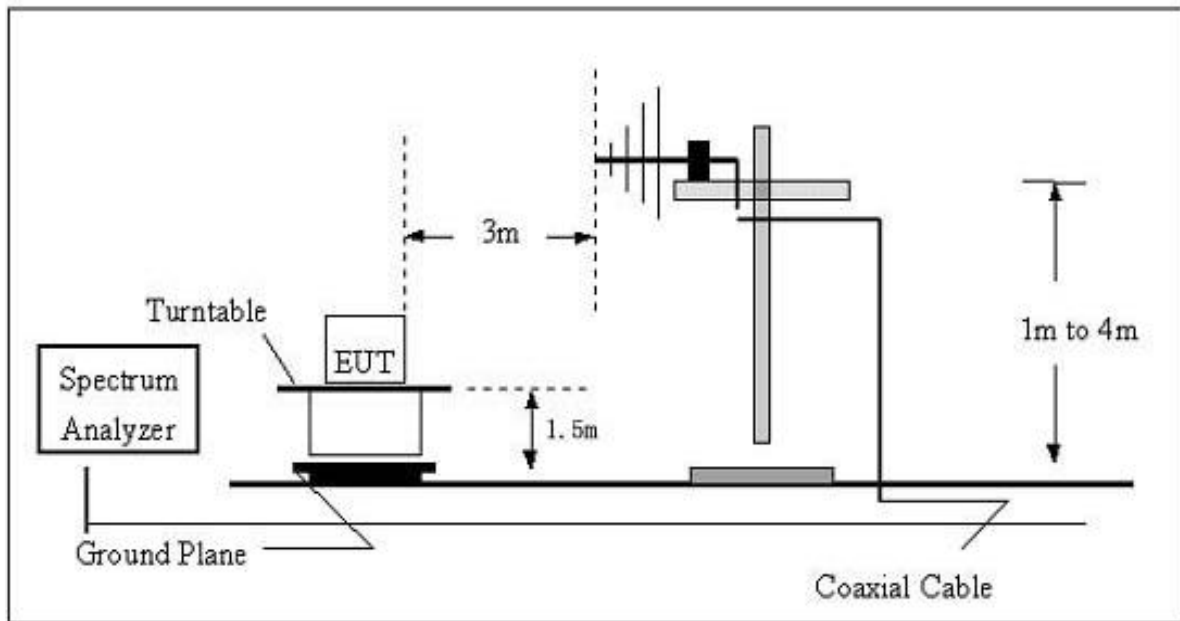
12.1 Block Diagram Of Test Setup

(A) Radiated Emission Test Set-Up Frequency Below 1GHz.



(B) Radiated Emission Test Set-Up Frequency Above 1GHz.

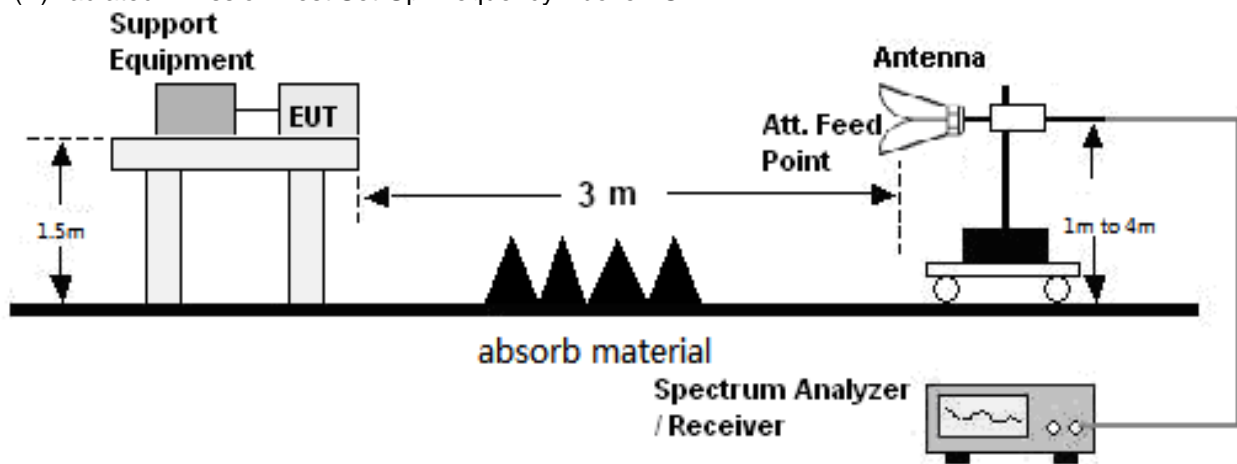

12.2 Limits

Frequency range	Maximum power, e.r.p. (≤ 1 GHz) e.i.r.p. (> 1 GHz)	Bandwidth
30 MHz to 47 MHz	-36 dBm	100 kHz
47 MHz to 74 MHz	-54 dBm	100 kHz
74 MHz to 87,5 MHz	-36 dBm	100 kHz
87,5 MHz to 118 MHz	-54 dBm	100 kHz
118 MHz to 174 MHz	-36 dBm	100 kHz
174 MHz to 230 MHz	-54 dBm	100 kHz
230 MHz to 470 MHz	-36 dBm	100 kHz
470 MHz to 694 MHz	-54 dBm	100 kHz
694 MHz to 1 GHz	-36 dBm	100 kHz
1 GHz to 12,75 GHz	-30 dBm	1 MHz

12.3 Test Procedure

30MHz ~ 1GHz:

- The Product was placed on the nonconductive turntable 1.5m above the ground in a full anechoic chamber.
- Set the spectrum analyzer/receiver in Peak detector, Max Hold mode, and 120 kHz RBW. Record the maximum field strength of all the pre-scan process in the full band when the antenna is varied between 1~4 m in both horizontal and vertical, and the turntable is rotated from 0 to 360 degrees.
- For each frequency whose maximum record was higher or close to limit, measure its QP value: vary the antenna's height and rotate the turntable from 0 to 360 degrees to find the height and degree where Product radiated the maximum emission, then set the test frequency analyzer/receiver to QP Detector and specified bandwidth with Maximum Hold Mode, and record the maximum value.

Above 1GHz:

- The Product was placed on the non-conductive turntable 1.5 m above the ground in a full anechoic chamber..
- Set the spectrum analyzer/receiver in Peak detector, Max Hold mode, and 1MHz RBW. Record the maximum field strength of all the pre-scan process in the full band when the antenna is varied in both horizontal and vertical, and the turntable is rotated from 0 to 360 degrees.
- For each frequency whose maximum record was higher or close to limit, measure its AV value: rotate the turntable from 0 to 360 degrees to find the degree where Product radiated the maximum emission, then set the test frequency analyzer/receiver to AV value and specified bandwidth with Maximum Hold Mode, and record the maximum value.

12.4 Test Results

Modulation : GFSK (the worst data)

Frequency (MHz)	Receiver Reading (dBm)	Turn table Angle Degree	RX Antenna		Correct	Absolute Level (dBm)	Result	
			Height (m)	Polar (H/V)	Factor (dBm)		Limit (dBm)	Margin (dB)
GFSK low channel								
556.39	-52.66	16	1.5	H	-7.52	-60.18	-54	-6.18
556.39	-52.11	231	1.1	V	-7.52	-59.63	-54	-5.63
4804.00	-41.22	204	1.5	H	-0.43	-41.65	-30	-11.65
4804.00	-42.96	75	1.8	V	-0.43	-43.39	-30	-13.39
7206.00	-55.75	312	1.1	H	8.31	-47.44	-30	-17.44
7206.00	-60.21	232	1.0	V	8.31	-51.90	-30	-21.90
GFSK Mid channel								
556.39	-52.56	190	1.1	H	-7.52	-60.08	-54	-6.08
556.39	-51.92	302	1.3	V	-7.52	-59.44	-54	-5.44
4882.00	-41.65	341	1.6	H	-0.38	-42.03	-30	-12.03
4882.00	-42.57	254	1.4	V	-0.38	-42.95	-30	-12.95
7323.00	-55.10	318	1.4	H	8.83	-46.27	-30	-16.27
7323.00	-61.15	182	1.6	V	8.83	-52.32	-30	-22.32
GFSK high channel								
556.39	-52.82	206	1.8	H	-7.52	-60.34	-54	-6.34
556.39	-52.94	25	1.6	V	-7.52	-60.46	-54	-6.46
4960.00	-40.67	116	1.1	H	-0.32	-40.99	-30	-10.99
4960.00	-42.50	294	1.3	V	-0.32	-42.82	-30	-12.82
7440.00	-56.02	327	1.9	H	9.35	-46.67	-30	-16.67
7440.00	-60.99	358	1.4	V	9.35	-51.64	-30	-21.64

Remark:

$$\text{Absolute Level} = \text{Receiver Reading} + \text{Factor}$$

$$\text{Factor} = \text{Antenna Factor} + \text{Cable Loss} - \text{Pre-amplifier.}$$

13. Receiver Spurious Emissions

13.1 Block Diagram Of Test Setup

(A) Radiated Emission Test Set-Up Frequency Below 1GHz.

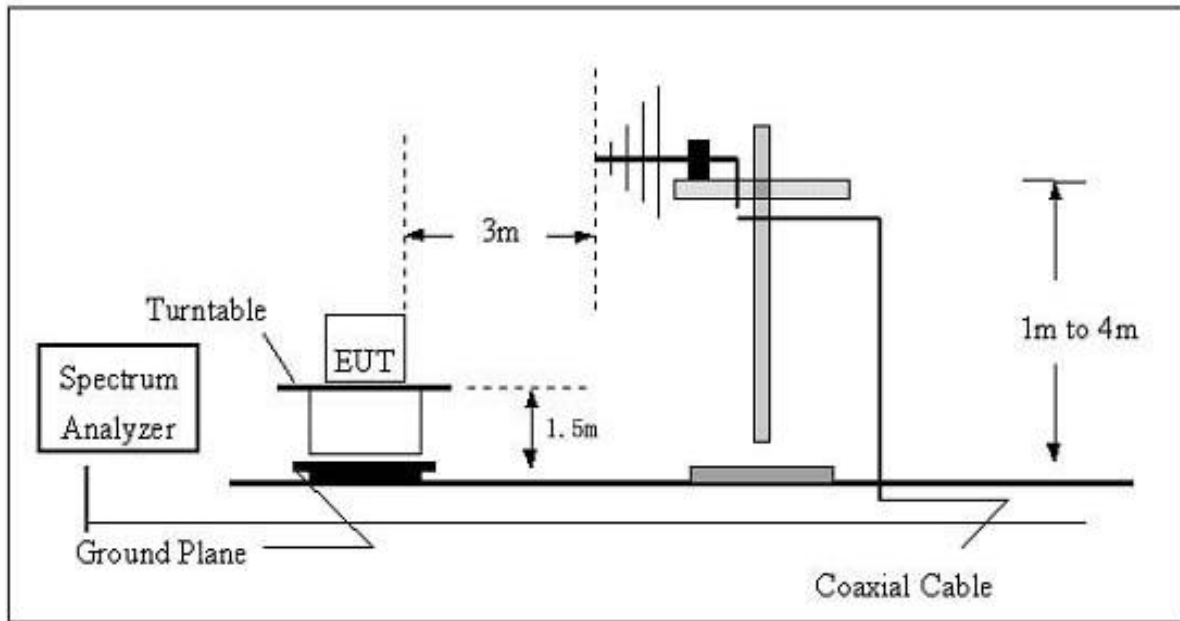

(B) Radiated Emission Test Set-Up Frequency Above 1GHz.

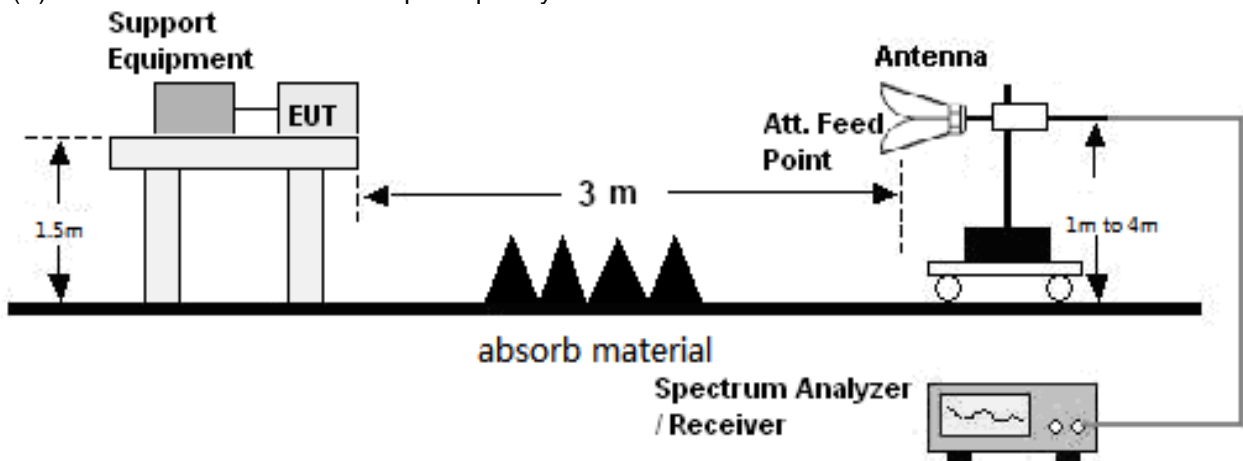

13.2 Limits

Frequency(MHz)	Limit	Bandwidth
30-1000	-57dBm	100 kHz
1000-12750	-47dBm	1 MHz

13.3 Test Procedure

30MHz ~ 1GHz:

- a. The Product was placed on the nonconductive turntable 1.5m above the ground in a full anechoic chamber.
- b. Set the spectrum analyzer/receiver in Peak detector, Max Hold mode, and 120 kHz RBW. Record the maximum field strength of all the pre-scan process in the full band when the antenna is varied between 1~4 m in both horizontal and vertical, and the turntable is rotated from 0 to 360 degrees.
- c. For each frequency whose maximum record was higher or close to limit, measure its QP value: vary the antenna's height and rotate the turntable from 0 to 360 degrees to find the height and degree where Product radiated the maximum emission, then set the test frequency analyzer/receiver to QP Detector and specified bandwidth with Maximum Hold Mode, and record the maximum value.

Above 1GHz:

- a. The Product was placed on the non-conductive turntable 1.5 m above the ground in a full anechoic chamber..
- b. Set the spectrum analyzer/receiver in Peak detector, Max Hold mode, and 1MHz RBW. Record the maximum field strength of all the pre-scan process in the full band when the antenna is varied in both horizontal and vertical, and the turntable is rotated from 0 to 360 degrees.
- c. For each frequency whose maximum record was higher or close to limit, measure its AV value: rotate the turntable from 0 to 360 degrees to find the degree where Product radiated the maximum emission, then set the test frequency analyzer/receiver to AV value and specified bandwidth with Maximum Hold Mode, and record the maximum value.

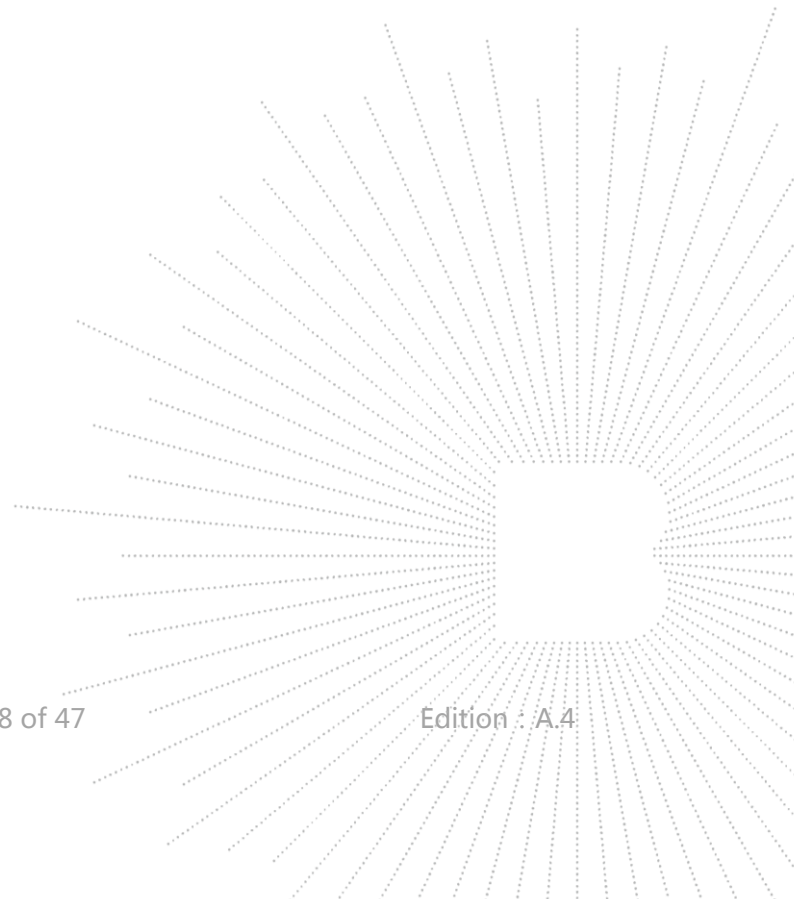

13.4 Test Results

Modulation : GFSK (the worst data)

Frequency	Receiver Reading	Turn table Angle	RX Antenna		Correct	Absolute Level	Result	
			Height	Polar	Factor		Limit	Margin
(MHz)	(dBm)	Degree	(m)	(H/V)	(dBm)	(dBm)	(dBm)	(dB)
GFSK low channel								
383.21	-54.27	9	1.4	H	-11.47	-65.74	-57.00	-8.74
383.21	-55.42	62	1.2	V	-11.47	-66.89	-57.00	-9.89
2490.39	-51.51	144	1.8	H	-6.80	-58.31	-47.00	-11.31
2490.39	-53.86	98	1.2	V	-6.80	-60.66	-47.00	-13.66
GFSK Mid channel								
383.21	-53.38	131	1.5	H	-11.47	-64.84	-57.00	-7.84
383.21	-55.59	190	1.2	V	-11.47	-67.06	-57.00	-10.06
2490.39	-51.05	322	1.0	H	-6.80	-57.85	-47.00	-10.85
2490.39	-53.37	221	1.5	V	-6.80	-60.17	-47.00	-13.17
GFSK high channel								
383.21	-55.12	287	2.0	H	-11.47	-66.59	-57.00	-9.59
383.21	-55.39	63	1.6	V	-11.47	-66.86	-57.00	-9.86
2490.39	-51.97	172	1.2	H	-6.80	-58.77	-47.00	-11.77
2490.39	-53.79	316	1.8	V	-6.80	-60.59	-47.00	-13.59

Remark:

$$\text{Absolute Level} = \text{Receiver Reading} + \text{Factor}$$

$$\text{Factor} = \text{Antenna Factor} + \text{Cable Loss} - \text{Pre-amplifier.}$$

14. Receiver Blocking

14.1 Block Diagram Of Test Setup

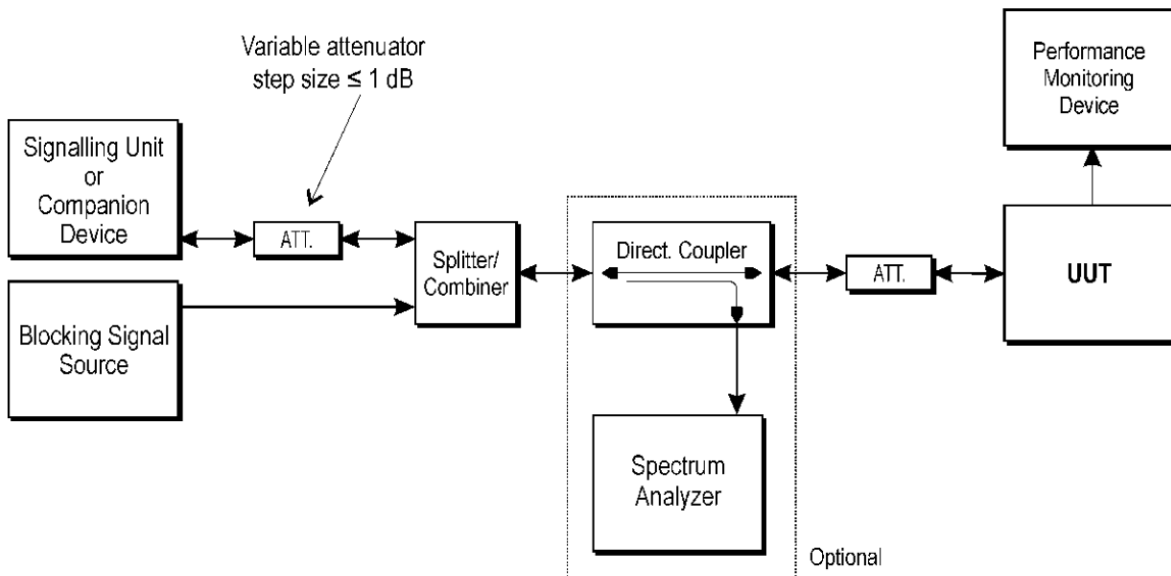

14.2 Limit

Table 7: Receiver Blocking parameters receiver Category 2 equipment

Wanted signal mean power from companion device (dBm) (see notes 1 and 3)	Blocking signal frequency (MHz)	Blocking signal power (dBm) (see note 3)	Type of blocking signal
$(-139 \text{ dBm} + 10 \times \log_{10}(\text{OCBW}) + 10 \text{ dB})$ or $(-74 \text{ dBm} + 10 \text{ dB})$ whichever is less (see note 2)	2 380 2 504 2 300 2 584	-34	CW
NOTE 1: OCBW is in Hz. NOTE 2: In case of radiated measurements using a companion device and the level of the wanted signal from the companion device cannot be determined, a relative test may be performed using a wanted signal up to $P_{\min} + 26 \text{ dB}$ where P_{\min} is the minimum level of wanted signal required to meet the minimum performance criteria as defined in clause 4.3.1.12.3 in the absence of any blocking signal. NOTE 3: The level specified is the level at the UUT receiver input assuming a 0 dBi antenna assembly gain. In case of conducted measurements, this level has to be corrected for the (in-band) antenna assembly gain (G). In case of radiated measurements, this level is equivalent to a power flux density (PFD) in front of the UUT antenna with the UUT being configured/positioned as recorded in clause 5.4.3.2.2.			

14.3 Test Procedure

Refer to ETSI EN 300 328 V2.2.2 (2019-07) Clause 5.4.11.2.

14.4 Test Result

Modulation : GFSK (the worst data)

Receiver Category 2					
GFSK Receiving	Wanted Signal Power(dBm)	Blocking Frequency(MHz)	Blocking Power(dB)	Measured PER(%)	Limit (%)
2402	-69.61	2380	-34	0.52	10
2402	-69.61	2300	-34	0.15	10
2480	-69.61	2504	-34	0.31	10
2480	-69.61	2584	-34	0.26	10

Note: This report only shows the worst case test data.
 OCBW=869000Hz
 $(-139\text{dBm} + 10 \cdot \log_{10}(\text{OCBW}) + 10\text{dB}) = -69.61\text{dBm}$
 $(-74\text{dBm} + 10\text{dB}) = -64\text{dBm}$
 $-69.61\text{dBm} \leq -64\text{dBm}$
 Wanted Signal Power= -69.61dBm

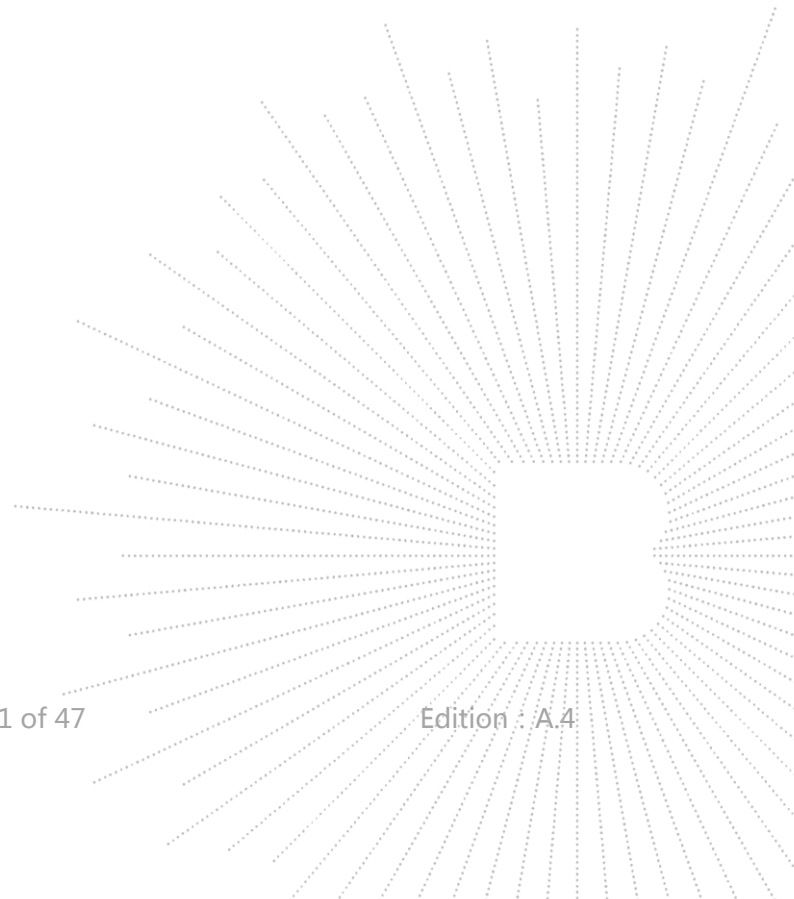

15. EUT Photographs

EUT Photo 1

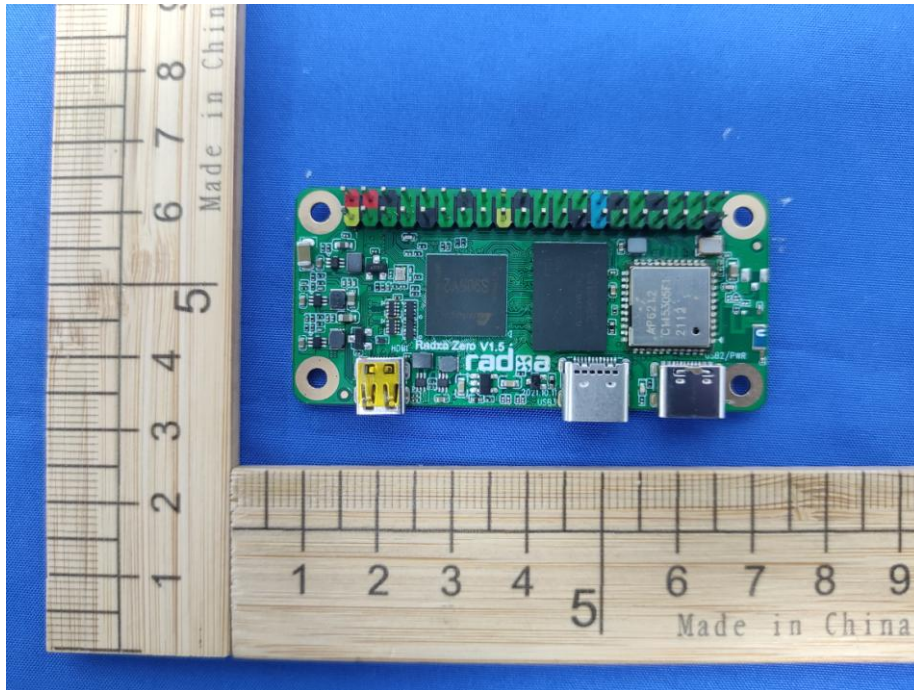

EUT Photo 2

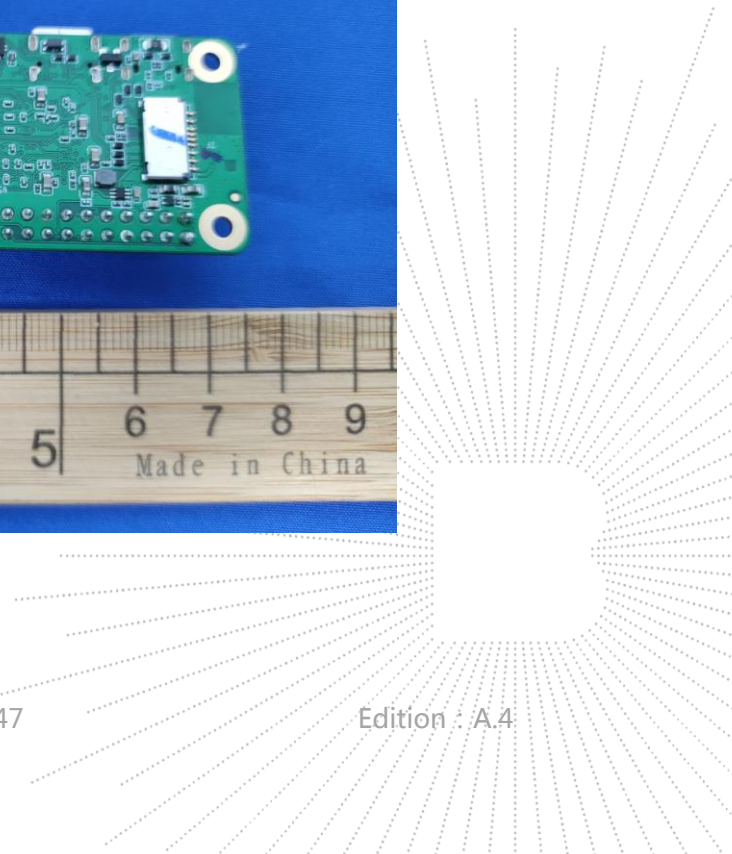
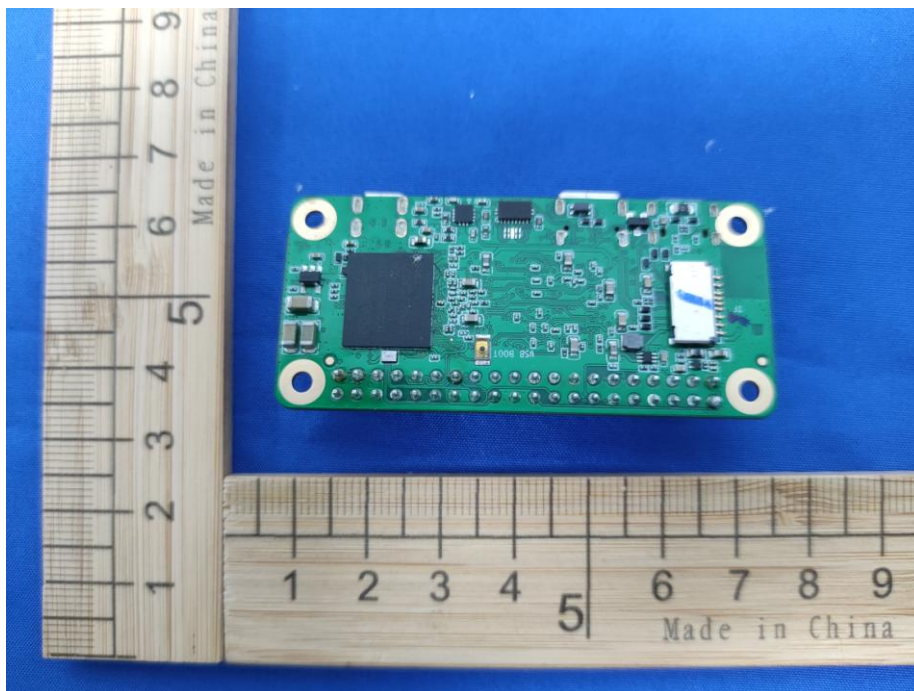

EUT Photo 3

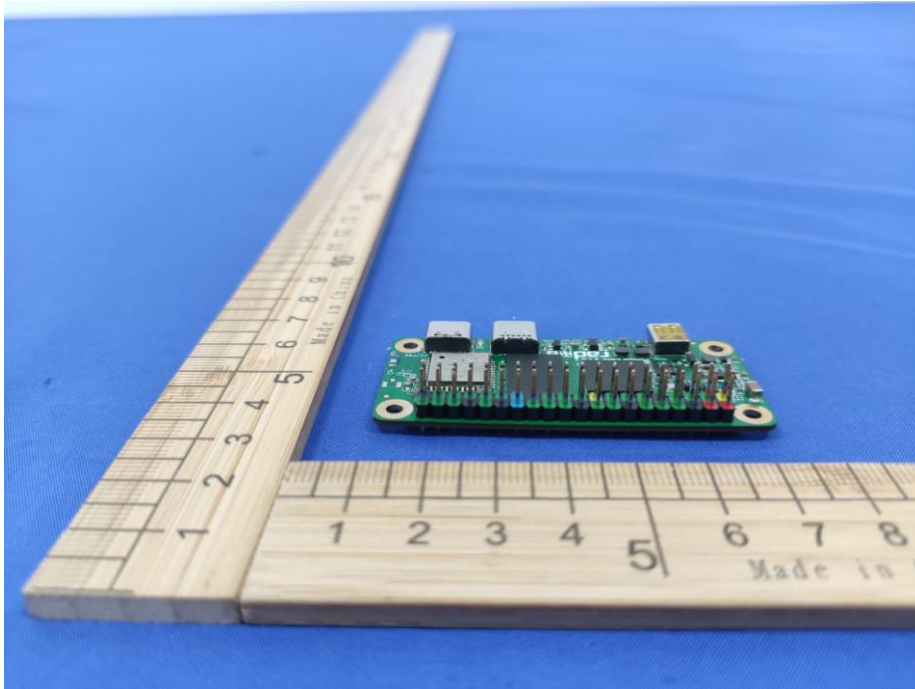

EUT Photo 4

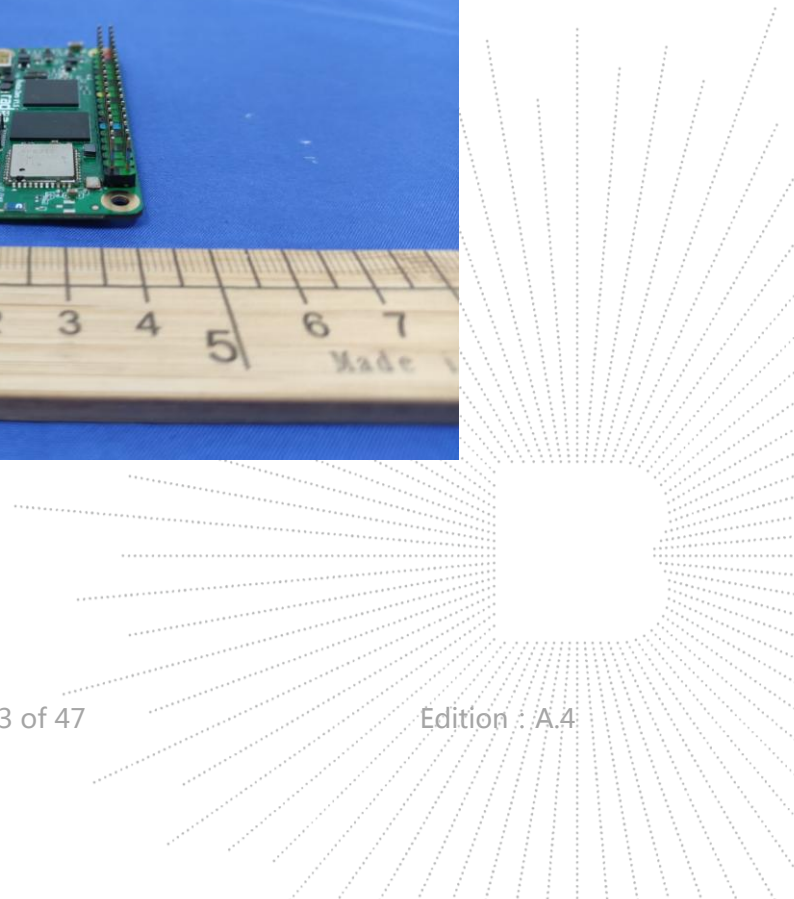
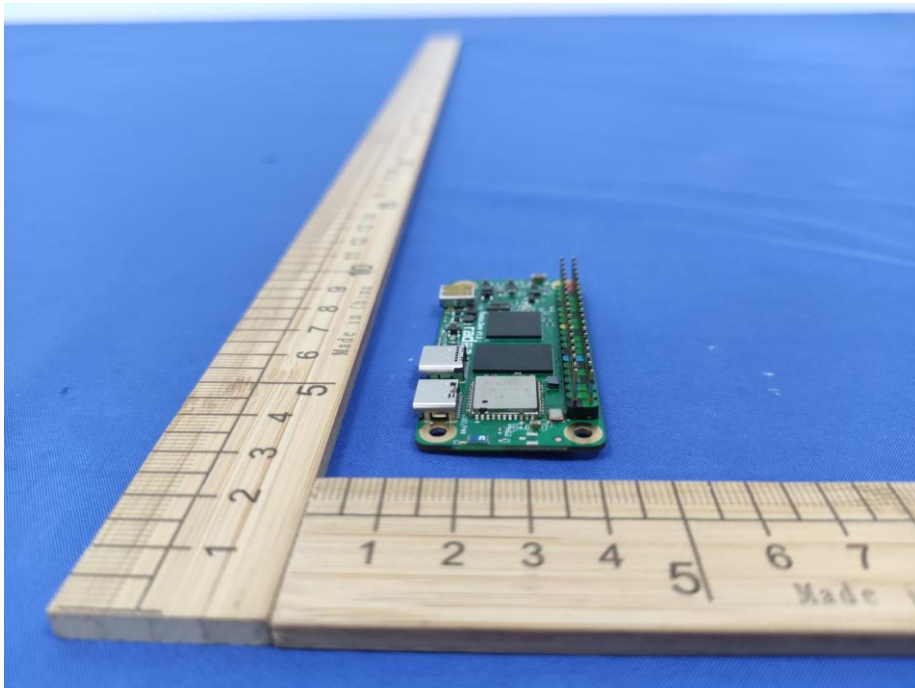

EUT Photo 5

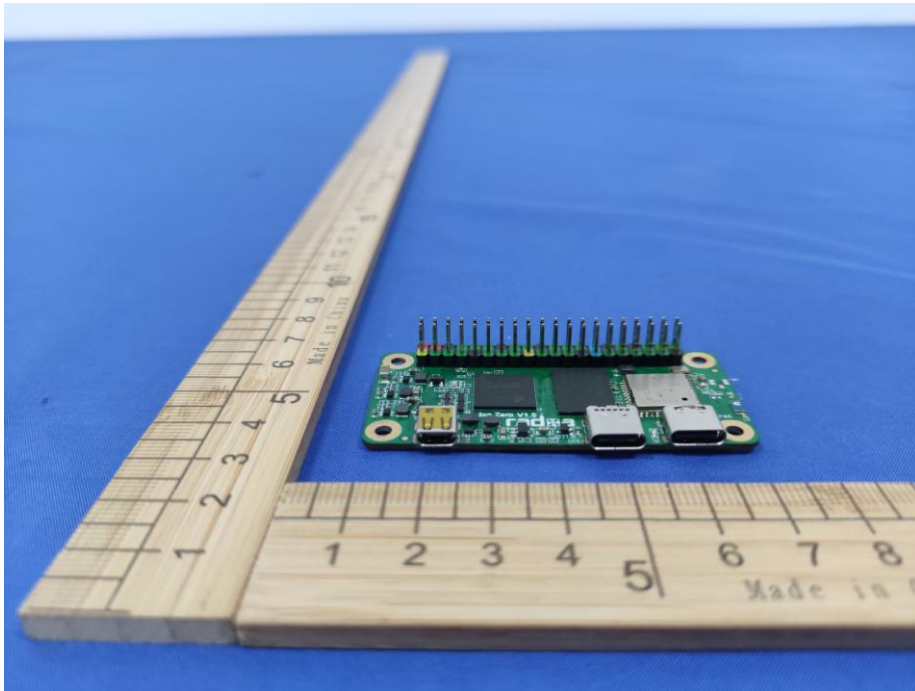

EUT Photo 6

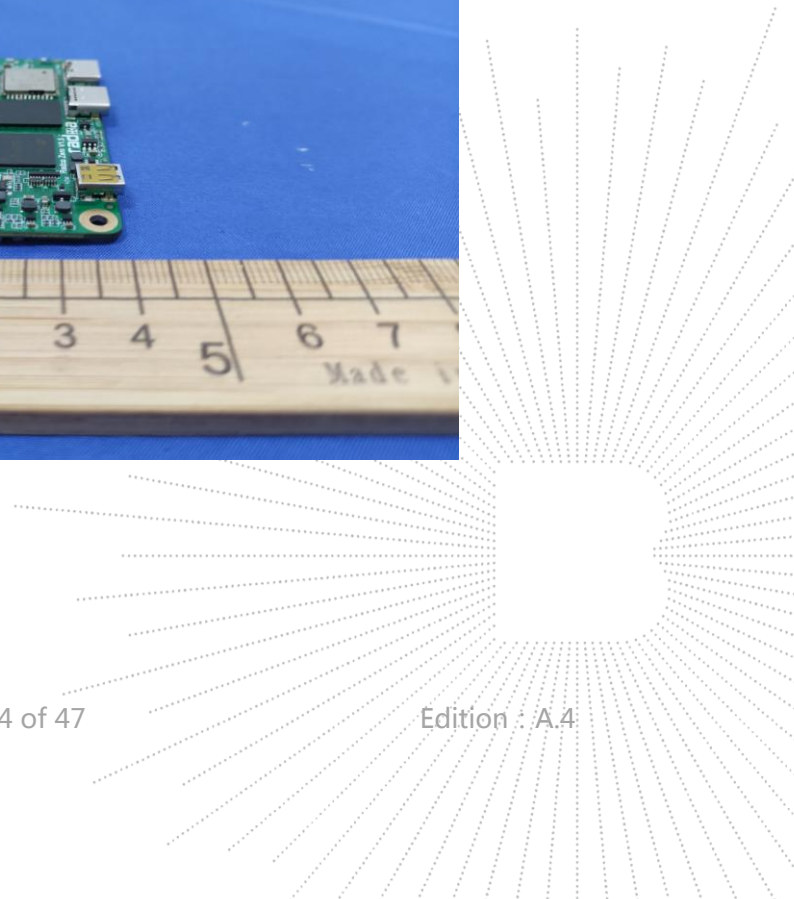
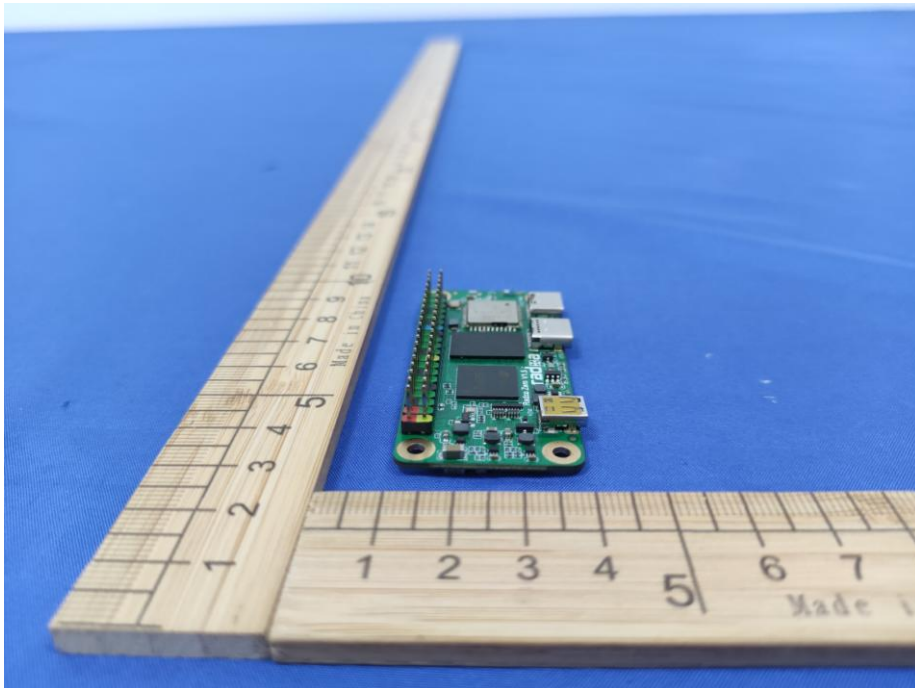

EUT Photo 7

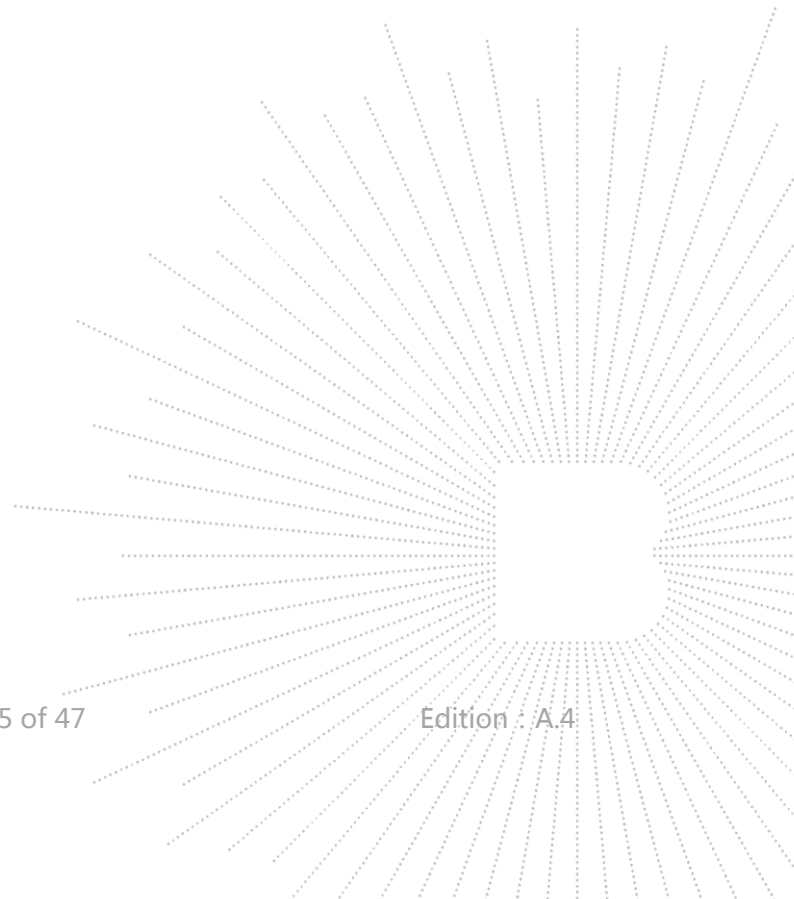
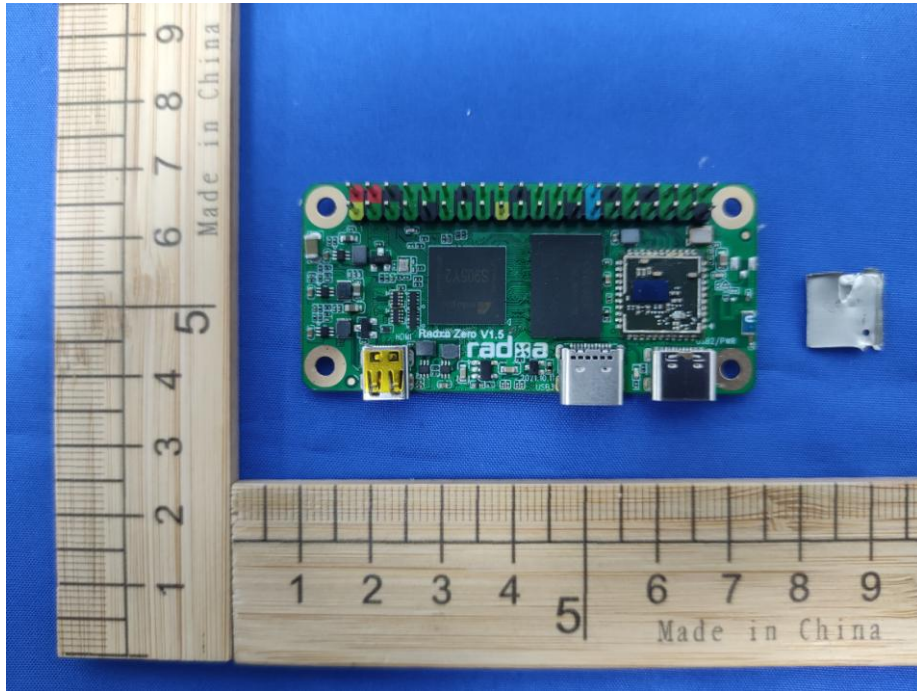

16. EUT Test Setup Photographs

Spurious emissions

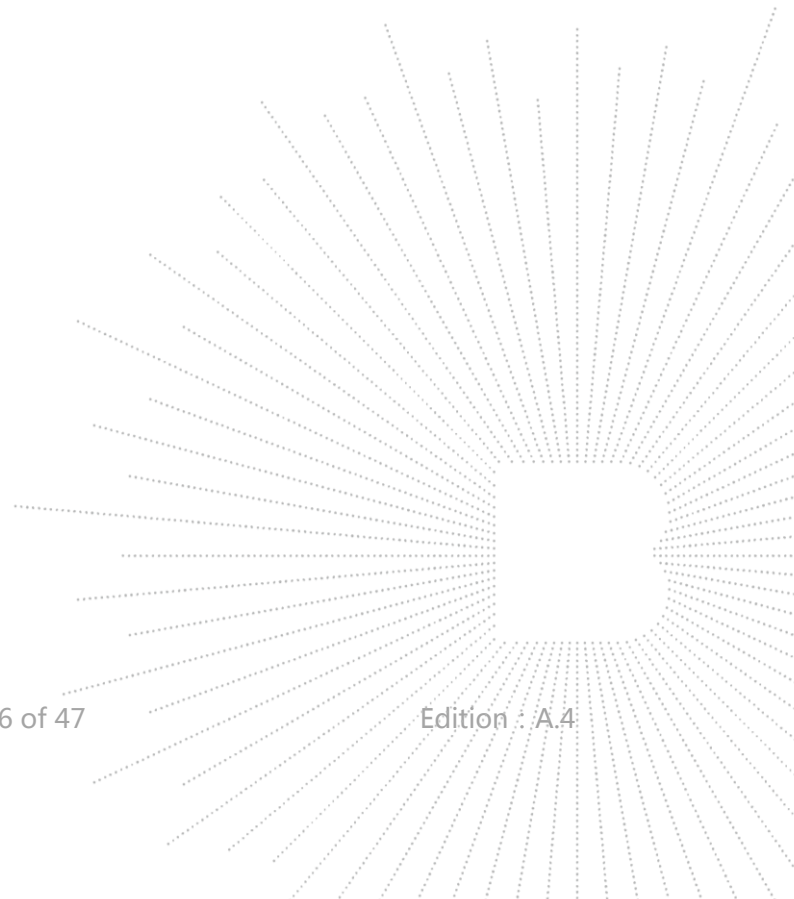

STATEMENT

- 1.The equipment lists are traceable to the national reference standards.
- 2.The test report can not be partially copied unless prior written approval is issued from our lab.
- 3.The test report is invalid without stamp of laboratory.
- 4.The test report is invalid without signature of person(s) testing and authorizing.
- 5.The test process and test result is only related to the Unit Under Test.
- 6.The quality system of our laboratory is in accordance with ISO/IEC17025.
- 7.If there is any objection to report, the client should inform issuing laboratory within 15 days from the date of receiving test report.

Address:

1-2/F., Building B, Pengzhou Industrial Park, No.158, Fuyuan 1st Road, Tangwei, Fuhai Subdistrict, Bao'an District, Shenzhen, Guangdong, China

TEL : 400-788-9558

P.C.: 518103

FAX : 0755-33229357

Website : <http://www.chnbctc.com>

E-Mail : bctc@bctc-lab.com.cn

***** END *****